

NOAA Technical Memorandum NMFS-NWFSC-23



In-Water Restoration Between Miller Sands and Pillar Rock Island, Columbia River: Environmental Surveys, 1992-93

September 1995

U.S. DEPARTMENT OF COMMERCE
National Oceanic and Atmospheric Administration
National Marine Fisheries Service

NOAA Technical Memorandum NMFS

The National Marine Fisheries Service's Northwest Fisheries Science Center uses the NOAA Technical memorandum series to issue informal scientific and technical publications when complete formal review and editorial processing are not appropriate or feasible due to time constraints. Documents within this series reflect sound professional work and may be referenced in the formal scientific and technical literature.

The NMFS-NWFSC Technical Memorandum series of the Northwest Fisheries Science Center continues the NMFS-F/NWC series established in 1970 by the Northwest Fisheries Center. The NMFS-AFSC series is now being used by the Alaska Fisheries Science Center.

This document should be cited as follows:

Hinton, S.A., G.T. McCabe, Jr., and R.L. Emmett. 1995. In-water restoration between Miller Sands and Pillar Rock Island, Columbia River; Environmental surveys, 1992-93. U.S. Dep. Commer., NOAA Tech. Memo. NMFS-NWFSC-23, 47 p.

Reference in this document to trade names does not imply endorsement by the National Marine Fisheries Service, NOAA.



In-Water Restoration Between Miller Sands and Pillar Rock Island, Columbia River: Environmental Surveys, 1992-93

Susan A. Hinton, George T. McCabe, Jr.,
and Robert L. Emmett

National Marine Fisheries Service
Northwest Fisheries Science Center
Coastal Zone and Estuarine Studies Division
2725 Montlake Blvd. E., Seattle, WA 98112

September 1995

U.S. DEPARTMENT OF COMMERCE

Ronald H. Brown, Secretary

National Oceanic and Atmospheric Administration

D. James Baker, Administrator

National Marine Fisheries Service

Rolland A. Schmitt, Assistant Administrator for Fisheries

This document is available to the public through:

National Technical Information Service
U.S. Department of Commerce
5285 Port Royal Road
Springfield, VA 22161

ABSTRACT

In 1992 and 1993, we studied benthic invertebrates, fishes, and bottom sediments at a proposed habitat restoration area, which is eroded, and an adjacent shallow subtidal habitat in the Columbia River estuary. The main objectives of the study were to document existing biological communities in the two areas and to provide habitat criteria for disposal of and stabilization of dredged material at the proposed restoration area. Data collected in the shallow subtidal habitat were used to provide the habitat criteria. Also, the shallow subtidal habitat was selected as a control site for future assessments of modifications to the proposed habitat restoration area.

Benthic invertebrate and sediment samples were collected at the two areas using a polyvinyl chloride (PVC) coring device; fishes were collected using a purse seine and semiballoon shrimp trawl. Total benthic invertebrate and amphipod (*Corophium spp.*) densities were significantly higher in the shallow subtidal habitat than in the proposed habitat restoration area ($P < 0.05$). Sediment characteristics between the two areas were also different. Median grain size was significantly larger in the proposed habitat restoration area than in the shallow subtidal habitat, and percent volatile solids were significantly lower in the proposed habitat restoration area than in the shallow subtidal habitat. Catches of subyearling chinook salmon (*Oncorhynchus tshawytscha*) in the proposed habitat restoration area and shallow subtidal habitat were similar in 1992; however, catches were significantly higher in the shallow subtidal habitat than in the proposed restoration area in 1993. The shallow subtidal habitat is probably more valuable to juvenile salmon because of its larger standing crops of *C. salmonis*, an important prey. Restoration of the eroded area should benefit juvenile salmon by increasing standing crops of *C. salmonis* in a small portion of the estuary. Guidelines for restoration of the eroded area will be provided to the U.S. Army Corps of Engineers, who will be responsible for the habitat modification.

CONTENTS

INTRODUCTION	1
METHODS	3
Sampling	3
Benthic Invertebrates and Sediments	3
Fishes and Shrimp	4
Data Analyses	6
Benthic Invertebrates	6
Fishes and Shrimp	8
Sediments	8
RESULTS	9
Benthic Invertebrates	9
Fishes and Shrimp	18
Sediments and Water Depths	21
DISCUSSION	26
ACKNOWLEDGMENTS	29
CITATIONS	30
APPENDIX FIGURES	33
APPENDIX TABLES	41

INTRODUCTION

In 1991, the National Oceanic and Atmospheric Administration (NOAA) and the U.S. Department of the Army signed a memorandum of agreement to restore and create fish habitat in the United States. Within NOAA, the National Marine Fisheries Service (NMFS) is responsible for conserving, managing, and developing the Nation's living marine resources. Within the Department of the Army, the U.S. Army Corps of Engineers (COE) is responsible for maintaining navigation channels. In addition, the COE has the authority to develop water resources, including protection and restoration of fish habitats using various means, such as identifying the beneficial use of dredged materials.

An area in the Columbia River estuary between Miller Sands and Pillar Rock Island (River Kilometer 40-42) (Fig. 1) is being investigated as a possible dredged material disposal site by the Portland District COE under its long-term management strategy for dredged-materials in the Columbia River estuary. The proposed disposal site is eroding at a rate of about 53,515 m³ of material annually. Since 1958, this area has eroded from a shallow subtidal habitat (0 to 1.8 m Columbia River Datum (CRD)) to a present minimum depth of 7.6 m CRD.

Providing that their hydraulic modeling studies do not predict any adverse changes in water circulation, the COE has proposed using dredged material to restore the eroded area to shallow subtidal habitat. The goal of this restoration is to attain benthic invertebrate and fish densities and species composition comparable to shallow subtidal and intertidal habitats in other areas of the Columbia River estuary (e.g., Rice Island, Grays Bay, and Cathlamet Bay). These areas support high densities of benthic invertebrates, including the amphipod *Corophium salmonis* (Holton et al. 1984; Emmett et al. 1986; Hinton et al. 1990, 1992a, b), an important food for juvenile Pacific salmon (*Oncorhynchus* spp.) (McCabe et al. 1983, 1986). Millions of juvenile Pacific salmon

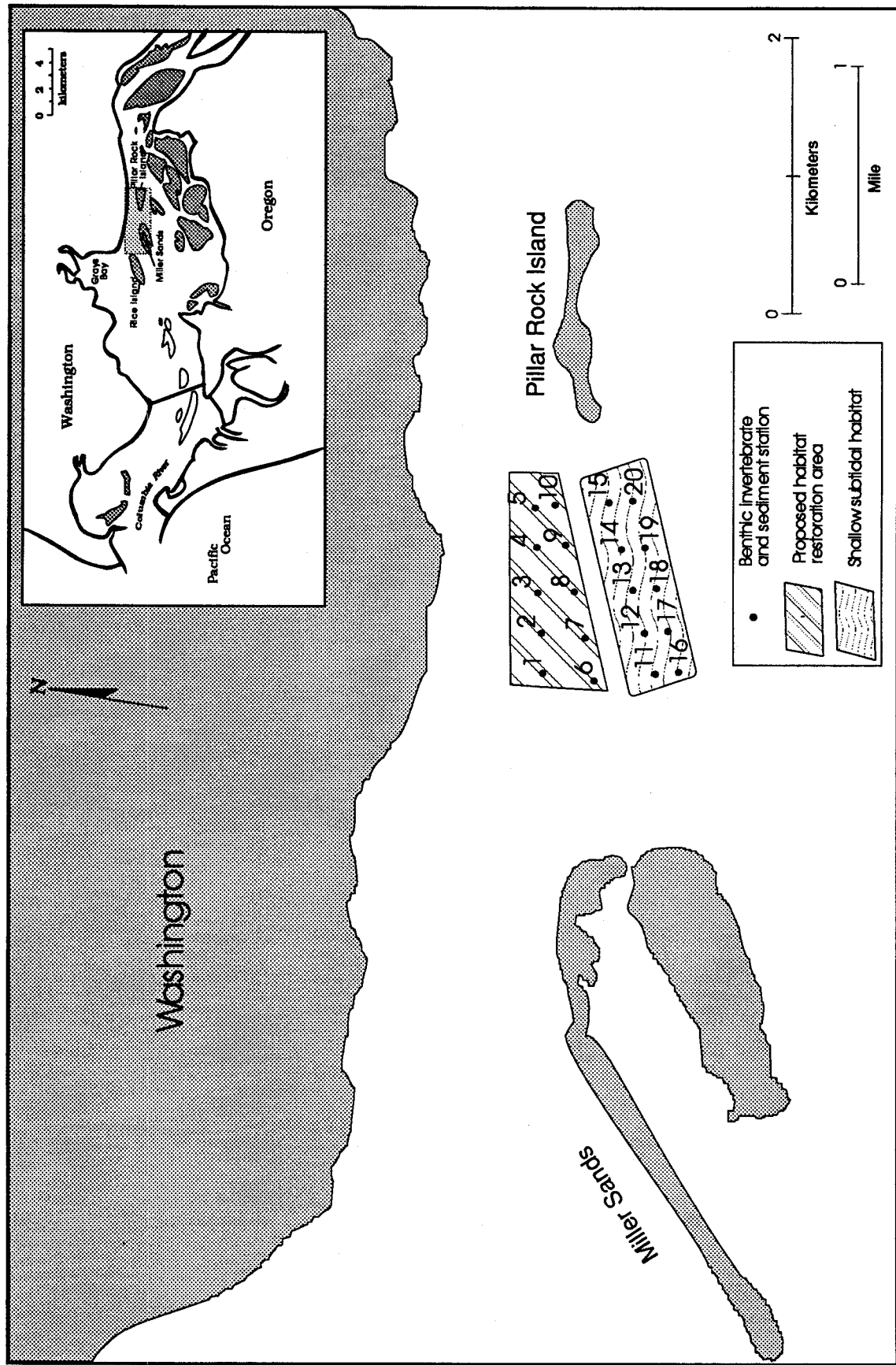

Figure 1. Benthic invertebrate and sediment sampling stations between Miller Sands and Pillar Rock Island, Columbia River estuary, July and September 1992 and May, July, and September 1993.

produced annually in the Columbia River Basin forage in these areas as they migrate through the Columbia River estuary en route to the Pacific Ocean.

In order to evaluate and develop this project, NMFS and COE require data regarding habitat parameters for design of the in-water fill and its associated pile-dike field, which is needed to stabilize the site. Therefore, in 1992 and 1993, NMFS studied benthic invertebrates, fishes, and sediments at the proposed habitat restoration area and an adjacent shallow subtidal habitat, both located between Miller Sands and Pillar Rock Island (Fig. 1). The primary objectives of this research were to document existing biological communities and provide habitat criteria (i.e. depth and sediment characteristics) for restoration of the eroded area using dredged material. Data collected in the shallow subtidal habitat were used to provide the habitat criteria for engineering and design of the proposed habitat restoration site. Also, the shallow subtidal habitat was selected as a control site for future assessments of modifications to the proposed habitat restoration area.

METHODS

Sampling

Benthic invertebrate and sediment samples, fishes, and shrimp were collected at the proposed habitat restoration area and adjacent shallow subtidal habitat in July and September 1992 and in May, July, and September 1993. Sampling station locations (latitude and longitude) were established using the Global Positioning System, which also allowed stations to be easily reoccupied (Appendix Table 1).

Benthic Invertebrates and Sediments

Eleven core samples were taken at each of 20 stations during each survey: 10 in the proposed habitat restoration area and 10 in the adjacent shallow subtidal habitat

(Fig. 1). Samples were collected with a polyvinyl chloride (PVC) coring device with an inside diameter of 3.85 cm, a penetrating depth of 15 cm, and a sample volume of 174.6-cm³ (Appendix Fig. 1). Samples were collected by scuba diving or snorkeling. Ten core samples from each station were placed in labeled jars and preserved in a buffered formaldehyde solution (=4%) containing rose bengal, a protein stain. In the laboratory, samples were washed with water through a 0.5-mm, screen. All benthic invertebrates were sorted from each sample, identified to the lowest practical taxon, counted, and stored in 70% ethanol. The 11th benthic sample from each station was placed in a labeled plastic bag and refrigerated for analysis of grain size, percent silt/clay, and percent volatile solids by the COE North Pacific Division Materials Laboratory, Troutdale, Oregon.

Fishes and Shrimp

In both the proposed habitat restoration area and adjacent shallow subtidal habitat, purse seining was conducted during each survey at three stations (Fig. 2). Fishes and shrimp were collected using a shallow-water purse seine (100 x 4.6 m) constructed of knotless nylon mesh, 17 mm. in the body and 13 mm. in the bunt. A round-haul technique was used to deploy the net. Typically, the net, which was stacked on the stern of an 8-m boat, was pulled off by a 5-m boat. During deployment, both boats traveled in a wide arc, completing a full circle by the time the net was fully extended. The net was then closed and pulled aboard the 8-m boat; fishes were hand-forced into the bunt where they could be collected before bringing the bunt aboard. In the proposed habitat restoration area, the purse seine sampled only the upper portion of the water column, at most the top 4.6 m; however, in the shallow subtidal habitat, the purse seine sampled much of the water column and at times the bottom.

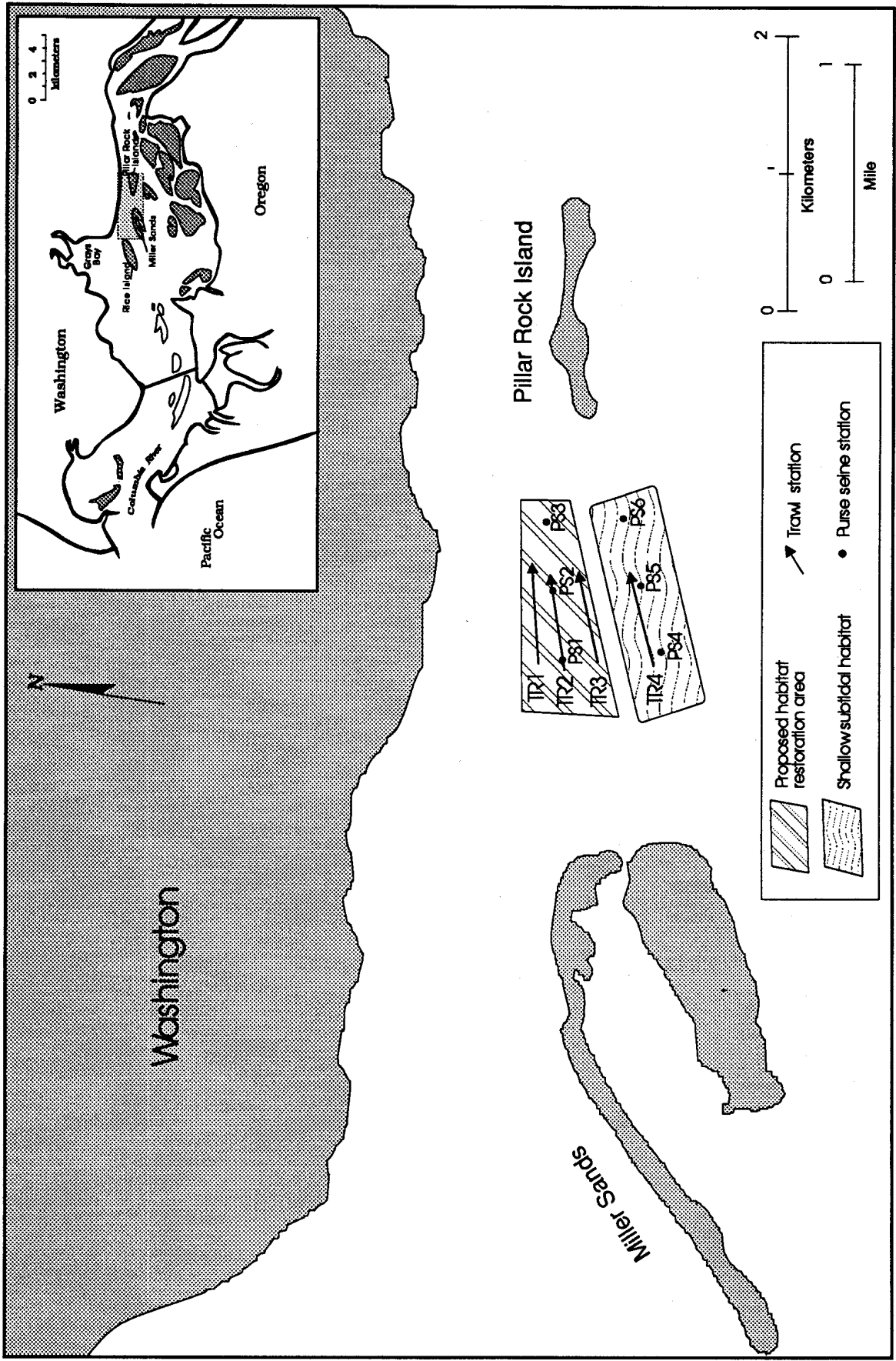

Figure 2. Purse seine and trawling stations between Miller Sands and Pillar Rock Island, Columbia River estuary, July and September 1992 and May, July, and September 1993.

Demersal fishes and shrimp in the proposed habitat restoration area were sampled at three stations during each survey using an 8-m (headrope length) semiballoon shrimp trawl (Fig. 2). The trawl had 38-mm (stretched measure) mesh in the body and a 10-mm mesh liner inserted in the cod end. The trawl was towed upstream for 5 minutes, and the distance traveled was estimated using a radar range-finder. Limited trawling was conducted in the shallow subtidal habitat to minimize juvenile salmonid injuries and mortalities, especially since three species of Pacific salmon in the Columbia River Basin have been listed as threatened or endangered under the Endangered Species Act. Capture in a shrimp trawl can badly descale juvenile salmonids. One trawl each was made in the shallow subtidal habitat in September 1992 and May, July, and September 1993. Because of the deeper water (>7.5 m mean lower low water (MLLW)) at the trawling stations in the proposed habitat restoration area, we were not concerned about catching juvenile salmonids in the shrimp trawl in this area. Juvenile salmonids are typically found near the surface, in deep water and therefore would not be vulnerable to capture in a shrimp trawl, except when retrieving the net.

At the collection sites, fishes and shrimp were identified, counted, and a maximum of 50 individuals of each fish species was measured (total length in millimeters) and weighed (grams). When more than 50 individuals of a species were collected at a site, the excess was counted and weighed as a group.

Data Analyses

Benthic Invertebrates

Benthic invertebrate data were analyzed by station to determine species composition, densities (by species and total), and community structure (diversity and equitability). The Shannon-Wiener function (H) was used to determine diversity (Krebs 1978). Diversity is expressed as

$$H = - \sum_{i=1}^s (p_i)(\log_2 p_i)$$

where $p_i = n_i/N$ (n_i is the number of individuals of the i th species in the sample, and N is the total number of all individuals in the sample) and $s =$ number of species. Equitability (E) was the second community structure index determined; E measures the proportional abundances among the various species in a sample (Krebs 1978) and ranges from 0.00 to 1.00, with 1.00 indicating all species in the sample are numerically equal. Equitability is expressed as

$$E = H/\log_2 s$$

where $H =$ Shannon-Wiener function and $s =$ number of species. Both H and E were calculated for each sampling station.

Total benthic invertebrate densities, *Corophium* spp. densities, H , and E were each compared between areas, years, and months using three-way analysis of variance (ANOVA) (Ryan et al. 1985); densities were transformed (\log_{10} or $\log_{10}(\text{density} + 1)$) prior to analysis. Data collected in May 1993 were excluded from these overall comparisons, because no sampling was conducted in May 1992. Two-way ANOVA was used to compare data collected in 1993; comparisons using the same types of observations listed above were made between the two areas and 3 months (May, July, and September). Means from the 10 samples at each sampling station provided the basic data entries for all statistical tests. When ANOVA results were significant ($P < 0.05$) for month in 1993, Fisher's protected least significant difference (FPLSD) (Petersen 1985) was used to identify significant differences between months.

Densities of *Corophium* spp. within the proposed habitat restoration area were compared between the north and south transects for 1992 and 1993 using two-way ANOVA. Data from 1992 and 1993 were not combined due to significant interaction between transect and year. Sampling stations in the north transect included Stations 1-5 and stations in the south transect included Stations 6-10.

Fishes and Shrimp

For each station, individual species and total fish and shrimp densities (number/hectare) and weights (grams/hectare) were estimated using the catch data and area sampled. The estimated sampling area of the purse seine was 795 m², which is the area of a circle having a 100-m (length of purse seine) circumference. The sampling area of the shrimp trawl was estimated using the distance traveled during each effort and the estimated fishing width of the trawl (5 m).

Two-way ANOVA was used to compare densities of subyearling chinook salmon (*O. tshawytscha*) collected with the purse seine between areas and months for 1993. The data were log₁₀ transformed prior to analysis. Similar comparisons were not made for 1992 because subyearling chinook salmon were captured in the purse seine only in July.

Sediments

Three-way ANOVA was used to compare median grain size and percent volatile solids between areas, years, and months. Percent volatile solids were transformed using (log₁₀ (value + 1)). Data collected in May 1993 were excluded from these overall comparisons, because no sampling was conducted in May 1992. Percent silt/clay values were not compared using ANOVA because of the non-normal distribution of the data. Two-way ANOVA was used to compare data collected in 1993; comparisons for median grain size and percent volatile solids (log₁₀ (value + 1)) were made between the two areas and 3 months (May, July, and September). When ANOVA results were significant ($P <$

0.05) for month in 1993, FPLSD was used to identify significant differences between months.

Median grain sizes within the proposed habitat restoration area were compared between the north and south transects separately for 1992 and 1993 using two-way ANOVA.

The relationship between median grain size and *Corophium* spp. density was investigated by using linear regression. *Corophium* spp. densities were transformed (\log_{10} or $\log_{10}(\text{density} + 1)$) prior to analysis. Two separate regressions were computed: one using data from July of 1992 and 1993 and the other using data from September of both years. The data were combined in this manner after ANOVA had shown no significant differences ($P > 0.05$) in *Corophium* spp. densities or median grain size between comparable months of the 2 years; but the data had shown significant differences ($P < 0.05$) between *Corophium* spp. densities in July and September of both years.

RESULTS

Benthic Invertebrates

Benthic invertebrate densities (total) were significantly different ($P < 0.05$) spatially and temporally in the proposed habitat restoration area compared to the adjacent shallow subtidal habitat located between Miller Sands and Pinar Rock Island. Densities were significantly higher in the shallow subtidal habitat than in the proposed habitat restoration area (ANOVA, $P < 0.05$) (Tables 1 and 2). In the shallow subtidal habitat, benthic invertebrate densities averaged more than 15,000 organisms/m² in July of 1992 and 1993 and more than 31,500 organisms/ m² in September of both years (Table 2). However, benthic invertebrate densities in the proposed habitat restoration area averaged less than 5,000 organisms/ m² in July of 1992 and 1993 and less than 18,200 organisms/

Table 1. Results of three-way and two-way analysis of variance for selected benthic invertebrate parameters measured at two areas (a proposed habitat restoration area and an adjacent shallow subtidal habitat) located between Miller Sands and Pillar Rock Island, Columbia River estuary, July and September 1992, and May, July, and September 1993. A significant difference ($P \leq 0.05$) is indicated with an *.

Parameter	Source	Degrees of freedom	F	P value
1992 and 1993				
Benthic invertebrate density (\log_{10}), total	Year (1992, 1993)	1	2.19	0.143
	Month (July, Sep)	1	40.93	0.000*
	Area	1	61.60	0.000*
	Total	79		
<i>Corophium</i> spp. density (\log_{10} of value + 1)	Year (1992, 1993)	1	1.94	0.168
	Month (July, Sep)	1	25.90	0.000*
	Area	1	38.79	0.000*
	Total	79		
Diversity (H)	Year (1992, 1993)	1	1.68	0.200
	Month (July, Sep)	1	23.01	0.000*
	Area	1	31.41	0.000*
	Total	79		
Equitability (E)	Year (1992, 1993)	1	2.08	0.154
	Month (July, Sep)	1	29.16	0.000*
	Area	1	0.02	0.881
	Month x area (interaction)	1	8.77	0.004*
	Total	79		
1993				
Benthic invertebrate density (\log_{10}), total	Month (May, July, Sep)	2	5.61	0.006*
	Area	1	18.45	0.000*
	Total	59		
<i>Corophium</i> spp. density (\log_{10} of value + 1)	Month (May, July, Sep)	2	8.28	0.001*
	Area	1	23.30	0.000*
	Total	59		
Diversity (H)	Month (May, July, Sep)	2	5.90	0.005*
	Area	1	12.76	0.001*
	Total	59		
Equitability (E)	Month (May, July, Sep)	2	6.35	0.003*
	Area	1	0.73	0.397
	Total	59		

Table 2. Densities (mean no./m²) of benthic invertebrates collected in a proposed habitat restoration area (Stations 1-10) and an adjacent shallow subtidal habitat (Stations 11-20) located between Miller Sands and Pillar Rock Island, Columbia River estuary, July and September 1992, and May, July, and September 1993.

Station	1992		1993	
	Mean no./m ²	SD	Mean no./m ²	SD
MAY				
1	-		945	488
2	-		1,289	1,163
3	-		1,203	1,679
4	-		2,863	2,060
5	-		11,682	4,585
6	-		46,729	13,577
7	-		41,060	10,480
8	-		27,230	5,139
9	-		38,912	13,326
10	-		47,502	16,964
Mean			21,941	6,946
11	-		46,672	11,167
12	-		41,490	11,331
13	-		36,937	4,617
14	-		37,366	11,717
15	-		39,857	8,706
16	-		61,074	19,278
17	-		12,198	2,456
18	-		35,648	11,158
19	-		7,216	3,992
20	-		31,954	8,137
Mean			35,041	9,256
JULY				
1	3,866	2,842	2,491	1,831
2	2,921	2,298	3,913	2,020
3	3,264	2,057	1,632	1,309
4	1,804	1,961	1,825	1,553
5	2,233	2,150	2,577	1,377
6	3,608	1,891	2,148	2,569
7	5,154	3,364	8,160	3,952
8	3,522	2,002	2,921	2,436
9	2,233	2,298	3,436	2,396
10	5,326	2,247	19,413	6,036
Mean	3,393	2,311	4,852	2,548

Table 2. Continued.

Station	1992		1993	
	Mean no./m ²	SD	Mean no./m ²	SD
JULY - (continued)				
11	35,648	4,568	33,672	7,486
12	16,493	6,387	3,436	1,856
13	9,535	3,276	11,940	3,276
14	34,455	6,506	28,604	5,655
15	6,442	4,422	9,621	4,805
16	38,826	5,879	19,843	8,323
17	22,506	5,652	11,167	3,057
18	5,498	2,503	10,480	4,839
19	12,026	6,260	8,762	3,455
20	31,611	7,354	13,572	4,282
Mean	21,304	5,281	15,110	4,703
SEPTEMBER				
1	15,634	6,953	6,357	2,535
2	11,425	2,106	7,731	4,563
3	18,382	6,922	7,731	3,733
4	18,812	6,757	7,044	4,753
5	14,431	6,112	1,289	1,090
6	35,992	8,764	12,971	6,972
7	4,381	2,160	12,885	6,454
8	29,206	5,910	63,909	9,970
9	6,872	3,265	10,737	3,513
10	3,866	2,504	50,680	10,379
Mean	15,900	5,145	18,133	5,396
11	48,189	15,654	52,141	6,716
12	59,356	11,159	32,040	7,412
13	59,786	6,632	11,081	3,174
14	56,178	5,511	25,340	9,904
15	16,149	5,354	63,995	14,517
16	48,275	8,777	58,669	10,324
17	27,230	6,630	24,739	5,534
18	41,804	12,269	7,063	2,675
19	53,429	7,420	11,253	2,342
20	62,277	14,243	30,494	5,571
Mean	47,267	9,365	31,681	6,817

m² in September of both years. In May 1993, benthic invertebrate densities averaged 21,941 organisms/ m² in the proposed habitat restoration area and 35,041 organisms/ m² in the shallow subtidal habitat. Benthic invertebrate densities were significantly higher in September than in July ($P < 0.05$). In 1993, benthic invertebrate densities were significantly higher in May and September than in July (ANOVA, FPLSD; $P < 0.05$); densities for May and September 1993 were not significantly different ($P > 0.05$). Overall, there was no significant difference in benthic invertebrate densities between 1992 and 1993, although May data were not included for this comparison since sampling was not conducted in May 1992.

Total numbers of taxa/categories (by month) collected in the proposed habitat restoration area and the adjacent shallow subtidal habitat were similar (Appendix Table 2), ranging from 13 to 22 for the entire study. The totals include all organisms collected, including some not normally closely associated with the benthos. At individual stations, the number of benthic invertebrate taxa/categories ranged from 3 to 12 in the proposed habitat restoration area and from 4 to 13 in the shallow subtidal habitat (Table 3).

Major benthic invertebrate taxa collected in the proposed habitat restoration area included oligochaetes, the bivalve *Corbicula fluminea*, the amphipod *Corophium salmonis*, and insect Ceratopogonidae (= Heleidae) larvae (Table 4). In the shallow subtidal habitat, turbellarians; oligochaetes, including their egg cases; the gastropod *Lithoglyphus virens*; *Corbicula fluminea*; *Corophium salmonis*; Chironomidae larvae; and Ceratopogonidae larvae were the major benthic invertebrate taxa. Summaries, by station, for the July and September 1992 and May, July, and September 1993 benthic invertebrate surveys are available upon request from NMFS, Northwest Fisheries Science Center, Point Adams Biological Field Station, P.O. Box 155, Hammond, OR 97121.

Table 3. Number of taxa/categories, Diversity (H), and Equitability (E) of benthic invertebrates collected in a proposed habitat restoration area (Stations 1-10) and an adjacent shallow subtidal habitat (Stations 11-20) located between Miller Sands and Pillar Rock Island, Columbia River estuary, July and September 1992, and May, July, and September 1993.

Station	1992			1993		
	No. of taxa	H	E	No. of taxa	H	E
MAY						
1	-	-	-	6	2.37	0.92
2	-	-	-	3	1.24	0.78
3	-	-	-	5	1.81	0.78
4	-	-	-	6	1.99	0.77
5	-	-	-	6	1.22	0.47
6	-	-	-	12	1.45	0.40
7	-	-	-	11	1.60	0.46
8	-	-	-	9	1.53	0.48
9	-	-	-	6	1.34	0.52
10	-	-	-	10	1.35	0.41
Mean	-	-	-	7	1.59	0.60
11	-	-	-	9	1.67	0.53
12	-	-	-	13	1.97	0.53
13	-	-	-	10	1.56	0.47
14	-	-	-	9	1.80	0.57
15	-	-	-	12	1.76	0.49
16	-	-	-	10	1.63	0.49
17	-	-	-	9	1.97	0.62
18	-	-	-	9	1.56	0.49
19	-	-	-	4	1.70	0.85
20	-	-	-	10	1.79	0.54
Mean	-	-	-	10	1.74	0.56
JULY						
1	4	1.56	0.78	3	0.57	0.36
2	3	1.01	0.64	4	1.40	0.70
3	4	1.32	0.66	6	1.97	0.76
4	4	1.41	0.70	3	1.17	0.74
5	6	1.64	0.64	5	1.80	0.78
6	6	1.84	0.71	4	1.54	0.77
7	6	1.89	0.73	6	2.01	0.78
8	7	1.65	0.59	5	1.98	0.85
9	5	1.69	0.73	5	1.89	0.82
10	6	2.03	0.79	9	1.92	0.61
Mean	5	1.60	0.70	5	1.63	0.72

Table 3. Continued.

Station	1992			1993		
	No. of taxa	H	E	No. of taxa	H	E
JULY - continued						
11	10	1.66	0.50	9	1.58	0.50
12	7	2.08	0.74	6	1.94	0.75
13	9	2.28	0.72	10	2.12	0.64
14	11	1.64	0.47	10	1.39	0.42
15	6	1.18	0.45	9	2.19	0.69
16	10	1.96	0.59	12	2.10	0.58
17	10	1.57	0.47	10	2.47	0.74
18	8	1.91	0.64	9	2.44	0.77
19	10	2.39	0.72	6	1.79	0.69
20	12	2.26	0.63	11	2.32	0.67
Mean	9	1.89	0.59	9	2.03	0.64
SEPTEMBER						
1	7	1.24	0.44	4	1.24	0.62
2	5	1.38	0.59	5	1.26	0.54
3	4	1.07	0.54	5	1.33	0.57
4	7	1.11	0.4	4	1.05	0.52
5	5	0.86	0.37	4	1.75	0.87
6	5	0.58	0.25	7	1.40	0.50
7	4	1.26	0.63	8	1.33	0.44
8	6	0.31	0.12	7	1.05	0.37
9	4	0.48	0.24	4	0.63	0.31
10	4	1.25	0.62	12	1.70	0.47
Mean	5	0.95	0.42	6	1.27	0.52
11	11	2.15	0.62	8	1.57	0.52
12	9	1.14	0.36	8	1.49	0.50
13	8	1.29	0.43	7	1.65	0.59
14	11	1.65	0.48	8	1.68	0.56
15	7	1.85	0.66	10	1.81	0.54
16	9	2.15	0.68	7	1.36	0.48
17	6	2.05	0.79	10	2.07	0.62
18	8	1.79	0.60	7	1.62	0.58
19	8	1.10	0.37	6	1.19	0.46
20	11	1.93	0.56	11	2.07	0.60
Mean	9	1.71	0.56	8	1.65	0.55

Table 4. Abundance (mean no./m²) of major benthic invertebrate taxa/categories collected in a proposed habitat restoration area and an adjacent shallow subtidal habitat located between Miller Sands and Pillar Rock Island, Columbia River estuary, July and September 1992, and May, July, and September 1993.

Taxon/category	May		July		September	
	1992	1993	1992	1993	1992	1993
PROPOSED HABITAT RESTORATION AREA						
Oligochaeta	-	10,301	86	1,239	43	2,156
Oligochaeta egg cases		0	0	0	0	1,400
Bivalvia						
<i>Corbicula fluminea</i>	-	1,017	1,366	973	1,091	661
Amphipoda						
<i>Corophium salmonis</i>	-	9,110	1,168	1,298	8,195	10,978
Insecta						
Ceratopogonidae larvae	-	436	619	1,070	6,193	2,362
Others	-	1,077	154	272	378	576
Total	-	21,941	3,393	4,852	15,900	18,133
SHALLOW SUBTIDAL HABITAT						
Turbellaria	-	830	155	266	223	77
Oligochaeta	-	10,745	3,248	4,415	3,988	4,355
Oligochaeta egg cases	-	0	5,127	0	7,840	3,009
Gastropoda						
<i>Lithoglyphus virens</i>	-	276	470	206	760	594
Bivalvia						
<i>Corbicula fluminea</i>	-	2,799	1,762	1,435	5,247	2,623
Amphipoda						
<i>Corophium salmonis</i>	-	18,611	9,134	6,958	27,801	20,062
Insecta						
Chironomidae larvae	-	86	596	112	320	249
Ceratopogonidae larvae	-	560	310	1,100	521	299
Other	-	1,134	502	618	567	413
Total	-	35,041	21,304	15,110	47,267	31,681

Overall, *Corophium salmonis* was the most abundant benthic invertebrate in both the proposed habitat restoration area and shallow subtidal habitat. *Corophium* spp. (most of which were *C. salmonis*) densities were significantly higher in the shallow subtidal habitat than in the proposed habitat restoration area (ANOVA, $P < 0.05$) and were significantly higher in September than in July ($P < 0.05$) (Tables 1 and 4). In 1993, *Corophium* spp. densities were significantly higher in May and September than in July (ANOVA, FPLSD; $P < 0.05$); densities for May and September 1993 were not significantly different ($P > 0.05$). Overall, there was no significant difference in densities between 1992 and 1993; May data were not included for this comparison since sampling was not conducted in May 1992. Within the proposed habitat restoration area, *Corophium* spp. densities were significantly higher for the south transect (Stations 6-10) than the north transect (Stations 1-5) in both 1992 and 1993 (ANOVA, $P < 0.05$).

Diversity (H) was significantly higher (ANOVA, $P < 0.05$) in the shallow subtidal habitat than in the proposed habitat restoration area and significantly higher in July than in September ($P < 0.05$) (Tables 1 and 3). In 1993, H was significantly higher in July than in September (ANOVA, FPLSD; $P < 0.05$); H values for May and July 1993 and for May and September 1993 were not significantly different ($P > 0.05$). Overall, there was no significant difference in H between 1992 and 1993; May data were not included for this comparison since sampling was not conducted in May 1992. The higher H values in the shallow subtidal habitat compared to the proposed habitat restoration area were due primarily to the higher number of taxa/categories in the shallow subtidal habitat. Diversity is also directly affected by E; however, E was not a major factor in the difference in H values between the two areas. Generally, mean E values for the proposed habitat restoration area were higher or similar to values measured for the shallow subtidal habitat (Table 3).

Fishes and Shrimp

Eighteen taxa, including 17 fish taxa and 1 shrimp taxon, were collected during the study (Appendix Table 3). Anadromous, marine, and freshwater fish species were collected in the proposed habitat restoration area and shallow subtidal habitat. Anadromous species included lamprey (Petromyzontidae), white sturgeon (*Acipenser transmontanus*), American shad (*Alosa sapidissima*), coho salmon (*Oncorhynchus kisutch*), sockeye salmon (*O. nerka*), chinook salmon, and steelhead (*O. mykiss*). The two marine species were Pacific staghorn sculpin (*Leptocottus armatus*) and starry flounder (*Platichthys stellatus*), both of which tolerate low salinities. Juvenile starry flounder can live in fresh water for relatively long periods of time. Freshwater species collected during the surveys included two cyprinids, peamouth (*Mylocheilus caurinus*) and northern squawfish (*Ptychocheilus oregonensis*); largescale sucker (*Catostomus macrocheilus*); banded killifish (*Fundulus diaphanus*); prickly sculpin (*Cottus asper*); and threespine stickleback (*Gasterosteus aculeatus*). Although the threespine stickleback is included with freshwater fishes, it can also live in marine and brackish waters (Hart 1973).

Overall, the most abundant fish species in the proposed habitat restoration area were peamouth, prickly sculpin, starry flounder, and juvenile salmonids (Table 5). All the abundant species except juvenile salmonids were captured near the bottom. In the shallow subtidal habitat, American shad, subyearling chinook salmon, peamouth, threespine stickleback, and starry flounder were the most abundant fish species. Summaries, by station, of individual fishing efforts for the July and September 1992 and May, July, and September 1993 surveys are available from NMFS, Point Adams Biological Field Station, P.O. Box 155, Hammond, OR 97121.

Because of bottom depth differences (Appendix Table 1), it is difficult to compare fish catches, particularly purse-seine catches, between the two areas. In the proposed

Table 5. Species composition and abundance of fishes and shrimp captured in a proposed habitat restoration area and an adjacent shallow subtidal habitat located between Miller Sands and Pillar Rock Island, Columbia River estuary, July and September 1992, and May, July, and September 1993. All values are mean numbers/hectare, except the trawl values for the shallow subtidal habitat which are numbers/hectare.

Species	May		July		September	
	1992	1993	1992	1993	1992	1993
PROPOSED HABITAT RESTORATION AREA						
BOTTOM TRAWL						
Lamprey	-	1	0	0	0	0
White sturgeon	-	2	0	2	0	0
American shad	-	0	5	0	76	26
Chinook salmon (0-age)	-	3	0	6	1	0
Unidentified cyprinid	-	0	2	0	0	0
Peamouth	-	36	68	660	545	748
Largescale sucker	-	67	0	0	0	0
Threespine stickleback	-	7	2	0	0	0
Unidentified sculpin	-	0	1	5	0	18
Prickly sculpin	-	57	20	91	146	9
Pacific staghorn sculpin	-	3	5	140	13	6
Starry flounder	-	44	82	73	282	36
California bay shrimp	-	0	9	0	79	0
Total	-	220	194	977	1,142	843
PURSE SEINE						
American shad	-	0	13	0	0	0
Chinook salmon (0-age)	-	101	335	394	0	13
Coho salmon	-	197	0	0	0	0
Sockeye salmon	-	285	0	0	0	0
Rainbow trout (steelhead)	-	109	0	0	0	0
Threespine stickleback	-	4	0	126	21	9
Total	-	696	348	520	21	22

Table 5. Continued.

Species	May		July		September	
	1992	1993	1992	1993	1992	1993
SHALLOW SUBTIDAL HABITAT						
BOTTOM TRAWL						
American shad	-	15	-	0	18	47
Chinook salmon (0-age)	-	118	-	609	0	122
Northern squawfish	-	0	-	0	0	5
Peamouth	-	69	-	30	500	61
Unidentified cyprinid	-	0	-	0	0	0
Largescale sucker	-	25	-	0	0	0
Threespine stickleback	-	187	-	4	0	362
Unidentified sculpin	-	0	-	0	0	33
Prickly sculpin	-	44	-	9	9	0
Pacific staghorn sculpin	-	5	-	17	0	0
Starry flounder	-	59	-	73	441	9
California bay shrimp	-	0	-	0	0	52
Total	-	522	-	742	968	691
PURSE SEINE						
White sturgeon	-	17	0	4	0	50
American shad	-	67	0	0	50	1,727
Chinook salmon (0-age)	-	440	369	1,044	0	1,707
Chinook salmon (1-age)	-	0	0	0	0	8
Coho salmon	-	9	0	0	0	4
Rainbow trout (steelhead)	-	25	0	0	0	0
Peamouth	-	54	101	0	180	143
Banded killifish	-	0	0	4	0	0
Northern squawfish	-	0	4	0	0	0
Threespine stickleback	-	46	356	575	71	361
Unidentified sculpin	-	0	0	0	4	0
Prickly sculpin	-	9	8	0	4	13
Pacific staghorn sculpin	-	4	0	21	0	4
Starry flounder	-	25	239	9	13	13
Total	-	696	1,077	1,657	322	4,030

habitat restoration area, the purse seine sampled only the upper portion of the water column, at most the top 4.6 m; however, in the shallow subtidal habitat, the purse seine sampled much of the water column and at times the bottom. Because juvenile salmon are typically surface-oriented even in deeper water, purse-seine catches of subyearling chinook salmon can be legitimately compared between the two areas. Densities of subyearling chinook salmon were similar in the two areas in July 1992, averaging 335 fish/hectare and 369 fish/hectare in the proposed habitat restoration area and shallow subtidal habitat, respectively (Table 5). In September 1992, no juvenile salmon were captured in the purse seine. In 1993, significantly (ANOVA, $P < 0.05$) higher numbers of subyearling chinook salmon were collected by purse seine in the shallow subtidal habitat than in the proposed habitat restoration area; however, there were no significant differences in catches between months. Densities of subyearling chinook salmon in 1993 averaged 169 fish/hectare in the proposed habitat restoration area and 1,064 fish/hectare in the shallow subtidal habitat.

Small numbers of California bay shrimp (*Crangon franciscorum*), a euryhaline species, were captured in the shrimp trawl in the proposed habitat restoration area and the shallow subtidal habitat (Table 5).

Length-frequency histograms of abundant fishes captured in both the proposed habitat restoration area and shallow subtidal habitat indicated that most were juveniles (Appendix Figs. 2-6). Virtually all chinook salmon collected in the two areas were subyearlings. All starry flounder collected during the two surveys were juveniles, most of which were subyearlings and yearlings.

Sediments and Water Depths

Median grain size was significantly larger in the proposed habitat restoration area than in the shallow subtidal habitat (ANOVA, $P < 0.05$; Tables 6 and 7). There were no

Table 6. Sediment characteristics in a proposed habitat restoration area (Stations 1-10) and an adjacent shallow subtidal habitat (Stations 11-20) located between Miller Sands and Pillar Rock Island, Columbia River estuary, July and September 1992 and May, July, and September 1993.

Station	1992			1993		
	Median grain size (mm)	Silt/clay (%)	Volatile solids (%)	Median grain size (mm)	Silt/clay (%)	Volatile solids (%)
			MAY			
1	-	-	-	0.34	0.7	0.6
2	-	-	-	0.43	0.1	0.6
3	-	-	-	0.26	1.0	0.8
4	-	-	-	0.19	2.2	1.0
5	-	-	-	0.16	4.4	1.1
6	-	-	-	0.10	14.1	2.3
7	-	-	-	0.15	7.3	1.6
8	-	-	-	0.29	11.6	0.9
9	-	-	-	0.08	28.1	1.9
10	-	-	-	0.09	24.8	2.3
Mean	-	-	-	0.21	9.4	1.3
11	-	-	-	0.15	12.9	1.6
12	-	-	-	0.12	23.3	1.2
13	-	-	-	0.19	12.2	1.5
14	-	-	-	0.19	4.5	1.1
15	-	-	-	0.09	30.3	2.3
16	-	-	-	0.15	11.9	1.1
17	-	-	-	0.24	5.2	0.9
18	-	-	-	0.24	6.1	1.0
19	-	-	-	0.33	0.7	0.6
20	-	-	-	0.20	5.1	0.9
Mean	-	-	-	0.19	11.2	1.2
			JULY			
1	0.37	0.1	0.5	0.34	0.7	0.0
2	0.45	0.1	0.5	0.47	0.4	1.0
3	0.40	0.4	0.4	0.47	0.0	1.0
4	0.46	0.3	0.4	0.56	0.0	1.0
5	0.30	0.1	0.6	0.31	0.6	1.0
6	0.19	0.0	0.6	0.22	0.1	0.0
7	0.20	0.1	0.5	0.38	1.0	0.4
8	0.18	0.3	0.5	0.18	0.6	1.0
9	0.21	0.2	0.5	0.17	1.2	0.8
10	0.16	0.1	0.8	0.12	6.0	2.0
Mean	0.29	0.2	0.5	0.32	1.1	0.8

Table 6. Continued.

Station	1992			1993		
	Median grain size (mm)	Silt/clay (%)	Volatile solids (%)	Median grain size (mm)	Silt/clay (%)	Volatile solids (%)
JULY-continued						
11	0.08	30.3	2.6	0.19	2.2	1.3
12	0.19	12.5	0.9	0.33	1.0	1.0
13	0.26	5.7	0.8	0.18	4.2	1.0
14	0.12	7.5	1.4	-	60.0	1.4
15	0.29	3.5	0.7	0.23	10.0	1.1
16	0.15	13.9	1.0	0.18	8.8	1.2
17	0.18	12.0	1.0	0.23	10.2	1.0
18	0.31	0.3	0.5	0.27	2.3	0.8
19	0.21	4.3	0.7	0.30	2.3	0.8
20	0.26	7.7	0.8	0.22	2.4	0.9
Mean	0.21	9.8	1.0	0.24	10.3	1.1
SEPTEMBER						
1	0.47	0.1	0.5	0.39	0.1	0.4
2	0.42	0.3	0.3	0.48	0.1	0.4
3	0.47	0.2	0.4	0.39	0.0	0.4
4	0.34	0.2	0.7	0.41	0.1	0.4
5	0.39	0.1	0.4	0.33	0.1	0.6
6	0.21	0.3	0.6	0.32	0.3	0.4
7	0.21	0.1	0.6	0.24	0.2	0.5
8	0.19	0.5	0.7	0.14	9.8	0.8
9	0.18	0.3	0.7	0.17	0.3	0.4
10	0.18	0.2	0.6	0.07	41.1	2.2
Mean	0.31	0.2	0.6	0.29	5.2	0.7
11	0.12	16.3	1.1	0.13	15.0	1.2
12	0.29	1.2	0.8	0.15	19.5	0.9
13	0.24	5.8	0.7	0.31	0.5	0.6
14	0.17	11.6	1.2	0.18	0.9	1.0
15	0.24	5.2	1.0	0.22	18.3	1.3
16	0.12	12.6	1.3	0.17	10.8	1.1
17	0.24	7.4	1.1	0.25	9.3	0.9
18	0.22	6.6	0.9	0.30	0.2	0.6
19	0.33	1.0	0.9	0.21	0.2	0.7
20	0.23	5.5	1.0	0.25	7.9	0.8
Mean	0.22	7.3	1.0	0.22	8.3	0.9

Table 7. Results of three-way and two-way analysis of variance for selected sediment parameters measured at two areas (a proposed habitat restoration area and an adjacent shallow subtidal habitat) located between Miller Sands and Pillar Rock Island, Columbia River estuary, July and September 1992, and May, July, and September 1993. A significant difference ($P \leq 0.05$) is indicated with an *.

Parameter	Source	Degrees of freedom	F	P value
1992 and 1993				
Median grain size	Year (1992, 1993)	1	0.08	0.785
	Month (July, Sep)	1	0.00	0.983
	Area	1	14.06	0.000*
	Total	79		
Volatile solids (%) (\log_{10} of value + 1)	Year (1992, 1993)	1	0.65	0.424
	Month (July, Sep)	1	0.67	0.416
	Area	1	24.98	0.000*
	Total	79		
1993				
Median grain size	Month (May, July, Sep)	2	2.39	0.101
	Area	1	5.84	0.019*
	Total	59		
Volatile solids (%) (\log_{10} of value + 1)	Month (May, July, Sep)	2	5.34	0.008*
	Area	1	3.06	0.086
	Total	59		

significant differences in median grain size between months or between years ($P > 0.05$). Overall, median grain size in the proposed habitat restoration area and shallow subtidal habitat averaged 0.28 mm. and 0.22 mm, respectively. In the proposed habitat restoration area, percent volatile solids in July and September were significantly lower than in the shallow subtidal habitat (ANOVA, $P < 0.05$) (Tables 6 and 7). Overall, there were no significant differences in percent volatile solids between years and months; May data were not included for these comparisons since sampling was not conducted in May 1992. In 1993, percent volatile solids were significantly higher in May than in July and September ($P < 0.05$); there were no significant differences between July and September 1993. Overall, percent volatile solids in the proposed habitat restoration area and shallow subtidal habitat averaged 0.8 and 1.0, respectively. Mean percent silt/clay was higher in the shallow subtidal habitat (overall 9.4%) than in the proposed habitat restoration area (overall 3.2%) (Table 6). During each survey, three or more stations in the shallow subtidal habitat had silt/clay percentages equal to or greater than 10%.

Within the proposed habitat restoration area, median grain size was significantly greater for the north transect (Stations 1-5) than the south transect (Stations 6-10) in both 1992 and 1993 (ANOVA, $P < 0.05$) (Table 6).

The regression relationships for median grain size and *Corophium* spp. density for July (1992 and 1993) and September (1992 and 1993) were significant ($P < 0.05$). The regression equation for July (1992 and 1993) was $\log_{10}(\text{Corophium spp. density} + 1) = 4.80 - 6.37(\text{median grain size})$; $F = 45.29$, $P = 0.000$, and $r^2 = 0.55$. The regression equation for September (1992 and 1993) was $\log_{10}(\text{Corophium spp. density}) = 5.04 - 4.37(\text{median grain size})$; $F = 43.04$, $P = 0.000$, and $r^2 = 0.53$. In each relationship, more than 53% of the variation in *Corophium* spp. density (transformed) was explained by median grain size. Water depths in the proposed habitat restoration area averaged 8.3 m

(MLLW), whereas in the shallow subtidal habitat, depths averaged 1.6 m (Appendix Table 1). Within the proposed habitat restoration area, mean water depths along the north and south transects were 9.7 m and 6.9 m, respectively.

DISCUSSION

One of the most important means of comparing the habitat values of areas of the Columbia River estuary for fishes, particularly migrating juvenile salmonids, is to assess the standing crops of benthic invertebrates, particularly *Corophium salmonis*, an important food for juvenile salmonids (McCabe et al. 1983, 1986). Benthic invertebrate communities are relatively stable on a short-term basis, in contrast to fish communities in the Columbia River estuary, which change rapidly, often daily. In addition, it is unknown how fishes utilize the two types of habitat investigated. For example, juvenile salmonids in the proposed habitat restoration area may have been simply migrating through the area, whereas many of the juvenile salmonids in the shallow subtidal habitat may have slowed their migration and been actively feeding.

Corophium salmonis at times is also an important prey for other fishes found in the study area, including peamouth, threespine stickleback, and starry flounder (McCabe et al. 1983). White sturgeon captured in the shallow subtidal habitat may also have been feeding on the abundant population of *C. salmonis*. Muir et al. (1988) and McCabe et al. (1993) observed that *C. salmonis* was the primary prey of young white sturgeon (< 800 mm, total length) in the Columbia River or its estuary. *Corophium* spp. sometimes are the major prey of recreationally legal-size white sturgeon (= 1,067 mm total length) (personal observations by authors).

The temporal abundance of *C. salmonis* in the study area followed a pattern similar to that found in nearby sections of the estuary. In our study, densities of *C. salmonis* were highest in May and September and lowest in July. In intertidal and shallow subtidal habitat

adjacent to Rice Island (RKm 34-36), densities of *C. salmonis* were higher in September 1991 than in July 1991 (Hinton et al. 1992a). In Grays Bay (RKm 38), Holton et al. (1984) observed that *C. salmonis* densities were lowest at the end of July, with increases in August and September. The increases in August and September were attributed to the production of fall of juveniles. McCabe and Hinton (1993) also found that densities of *C. salmonis* were higher in September than in July 1992 at an intertidal habitat in Grays Bay (RKm 37).

Standing crops of *C. salmonis* in the shallow subtidal area in our study were generally comparable to or in some instances considerably lower than those observed near Rice Island and in Grays Bay. In intertidal and shallow subtidal habitat adjacent to Rice Island, densities of *C. salmonis* averaged 8,407 organisms/m² in July 1991 and 31,418 organisms/m² in September 1991 (Hinton et al. 1992a). Densities of *C. salmonis* in nonvegetated intertidal habitat in Grays Bay in 1992 averaged 7,516 organisms/m² in July and 79,800 organisms/m² in September (McCabe and Hinton 1993). In our study, *C. salmonis* densities averaged 9,134 and 6,958 organisms/m² in July 1992 and 1993, respectively; and 27,801 and 20,062 organisms/m² in September 1992 and 1993, respectively.

Habitats within the proposed habitat restoration area appeared to be separated into at least two types. Habitats along the north and south transects were distinctly different, as evidenced by significant differences ($P < 0.05$) in sediment grain size and *Corophium* spp. densities. Water depths were also less along the south transect than along the north transect. Bottom water velocities are probably less along the south transect, which result in more favorable substrate for colonization by *C. salmonis*. *Corophium salmonis* is a tube-building amphipod that lives in and on the bottom, with periodic migrations into the water column (Davis 1978).

Major differences between the proposed habitat restoration area and shallow subtidal habitat were identified in 1992 and 1993. Total benthic invertebrate and *Corophium* spp. densities were significantly higher in the shallow subtidal habitat than in the proposed habitat restoration area ($P < 0.05$). In addition, there were major differences in sediment characteristics between the proposed habitat restoration area and the shallow subtidal habitat. Median grain size was significantly higher in the proposed habitat restoration area than in the shallow subtidal habitat, whereas percent volatile solids were significantly lower in the proposed habitat restoration area than in the shallow subtidal habitat. Percent silt/clay was also lower in the proposed habitat restoration area (overall 3.2%) than in the shallow subtidal habitat (overall 9.4%). Densities of subyearling chinook salmon in the proposed habitat restoration area and shallow subtidal habitat were similar in 1992; however, in 1993, densities were significantly higher ($P < 0.05$) in the shallow subtidal habitat than in the proposed restoration area.

Results from our research suggest that the habitat value of the proposed habitat restoration area could be enhanced by proper placement and stabilization of dredged material from the Columbia River to create habitat comparable to that in the adjacent shallow subtidal area. By placing dredged material in the proposed habitat restoration area and stabilizing it, more favorable habitat for *C. salmonis* will be created (i.e., water velocities will be reduced, resulting in a decrease in median grain size and an increase in percent silt/clay and percent volatile solids). Subsequent increases in standing crops of *C. salmonis* should provide more food and rearing habitat for fishes, including migrating juvenile salmonids. However, hydraulic modeling studies need to be completed to determine if any adverse changes in water circulation in the Columbia River estuary would result from the proposed habitat modification. Adverse changes in water circulation could negate the benefits of the proposed habitat modification.

ACKNOWLEDGMENTS

We thank Earl Dawley, Sheila Turner, and Roy Pettit for their assistance with sampling. Benjamin Sandford provided advice regarding statistical analyses of the data. Loretta Dawley and Beverly Heskiss assisted in the analysis of benthic invertebrate samples. Funding for this study was provided by the NMFS-COE program to restore and create fishery habitat.

CITATIONS

- Davis, J. S. 1978. Diel activity of benthic crustaceans in the Columbia River estuary. M.S. Thesis. Oreg. State Univ., Corvallis.
- Emmett, R. L., G. T. McCabe, Jr., T. C. Coley, R. J. McConnell, and W. D. Muir. **1986.** Benthic sampling in Cathlamet Bay, Oregon--1984. Report to the U. S. Army Corps of Engineers, Contract DACW57-84-F-0348, 11 p. plus appendices. (Available from Northwest Fisheries Science Center, 2725 Montlake Blvd. E., Seattle, WA 98112.)
- Hart, J. L. 1973. Pacific fishes of Canada. Fish. Res. Board Can. Bull. 180, 740 p.
- Hinton, S. A., R. L. Emmett, and G. T. McCabe, Jr. 1992a. Fishes, shrimp, benthic invertebrates, and sediment characteristics in intertidal and subtidal habitats at Rice Island and Miller Sands, Columbia River estuary, 1991. Report to the U.S. Army Corps of Engineers, Contract E96910025, 44 p. plus appendix. (Available from Northwest Fisheries Science Center, 2725 Montlake Blvd. E., Seattle, WA 98112.)
- Hinton, S. A., R. L. Emmett, and G. T. McCabe, Jr. 1992b. Benthic invertebrates and sediment characteristics in subtidal habitat at Rice Island, Columbia River estuary, December 1991 and March 1992. Report to the U.S. Army Corps of Engineers, Contract E96920018, 14 p. plus appendix. (Available from Northwest Fisheries Science Center, 2725 Montlake Blvd. E., Seattle, WA 98112.)

- Hinton, S. A., G. T. McCabe, Jr., and R. L. Emmett. 1990. Fishes, benthic invertebrates, and sediment characteristics in intertidal and subtidal habitats at five areas in the Columbia River estuary. Report to the U.S. Army Corps of Engineers, Contracts E86880158, E8680107, E86900048, 92 p. plus appendix. (Available from Northwest Fisheries Science Center, 2725 Montlake Blvd. E., Seattle, WA 98112.)
- Holton, R. L., D. L. Higley, M. A. Brzezinski, K. M Jones, and S. L. Wilson. 1984. Benthic infauna of the Columbia River estuary. Final Report on the Benthic Infauna Work Unit of Columbia River Estuary Data Development Program, 179 p. plus appendices. (Available from CREST, 748 Commercial St., Astoria, OR 97103.)
- Krebs, C. J. 1978. Ecology: the experimental analysis of distribution and abundance. Harper and Row. New York, 678 p.
- McCabe, G. T., Jr., R. L. Emmett, and S. A. Hinton. 1993. Feeding ecology of juvenile white sturgeon (*Acipenser transmontanus*) in the lower Columbia River. Northwest Sci. 67(3):170-180.
- McCabe, G. T., Jr., R. L. Emmett, W. D. Muir, and T. H. Blahm. 1986. Utilization of the Columbia River estuary by subyearling chinook salmon. Northwest Sci. 60(2):113-124.

McCabe, G. T., Jr., and S. A. Hinton. 1993. Benthic invertebrates and sediments in vegetated and nonvegetated habitats at three intertidal areas of the Columbia River estuary, 1992. Report to the U.S. Army Corps of Engineers, Contract E9592012, 16 p. plus appendix. (Available from Northwest Fisheries Science Center, 2725 Montlake Blvd. E., Seattle, WA 98112.)

McCabe, G. T., Jr., W. D. Muir, R. L. Emmett, and J. T. Durkin. 1983. Interrelationships between juvenile salmonids and nonsalmonid fish in the Columbia River estuary. *Fish. Bull.*, U.S. 81(4):815-826.

Muir, W. D., R. L. Emmett, and R. J. McConnell. 1988. Diet of juvenile and subadult white sturgeon in the lower Columbia River and its estuary. *Calif. Fish Game* 74(1):49-54.

Petersen, R. G. 1985. Design and analysis of experiments. Marcel Dekker, Inc. New York, 429 p.

Ryan, B. F., B. L. Joiner, and T. A. Ryan, Jr. 1985. Minitab handbook, 2nd edition. PWS-KENT Pub., Boston, 386 p.

APPENDIX FIGURES

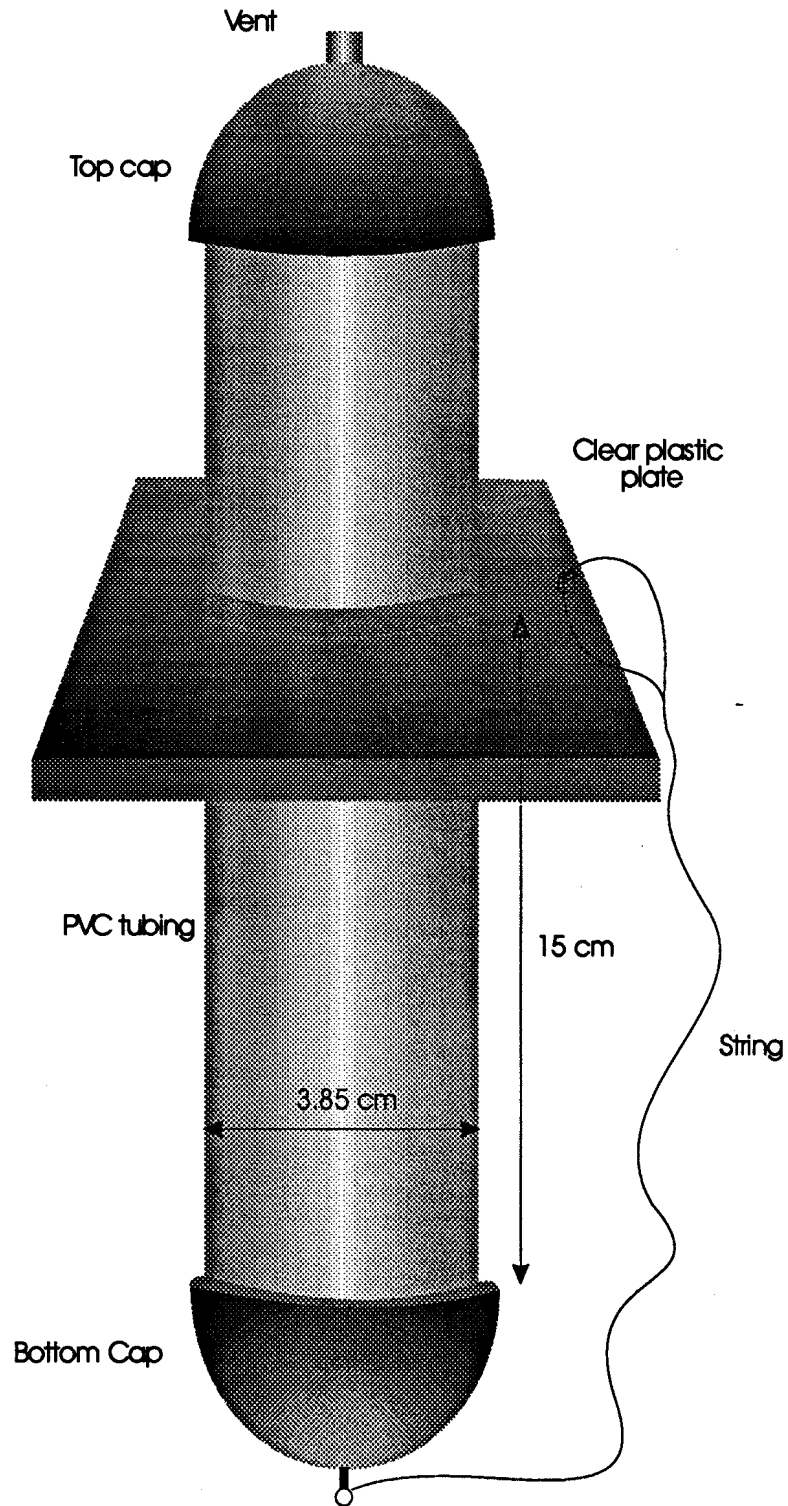

Appendix Figure 1. PVC coring device used to collect benthic invertebrate and sediment samples in a proposed habitat restoration area and an adjacent shallow subtidal habitat located between Miller Sands and Pillar Rock Island, Columbia River estuary, July and September 1992 and May, July, and September 1993.

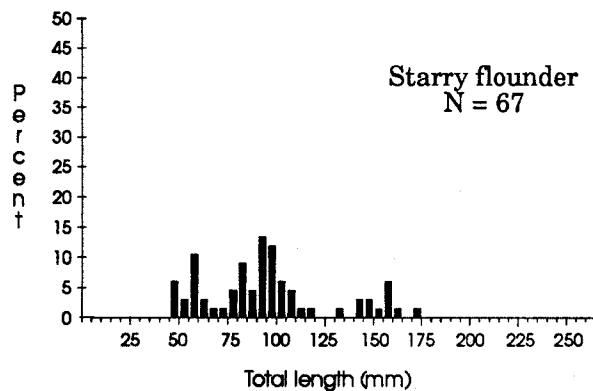
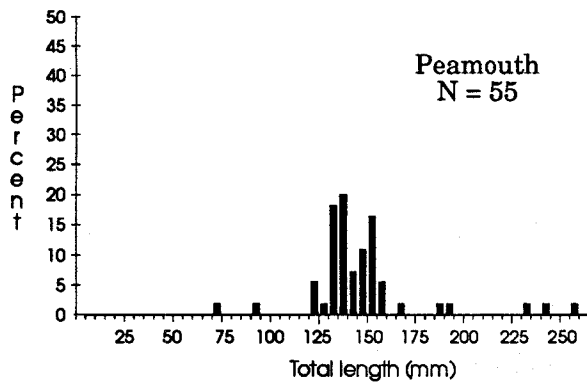
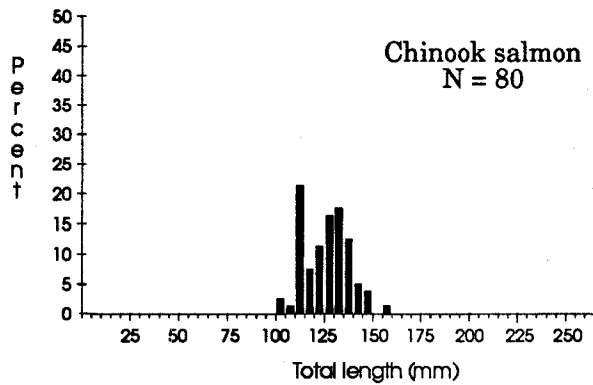
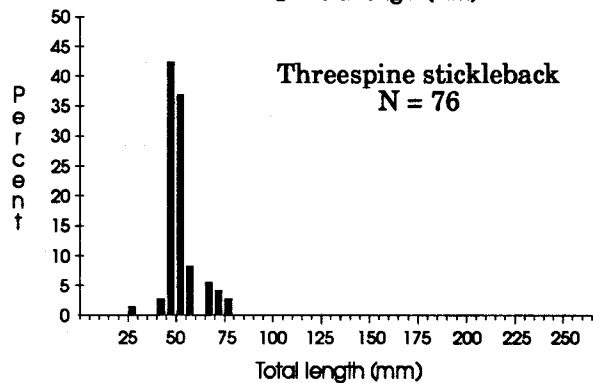
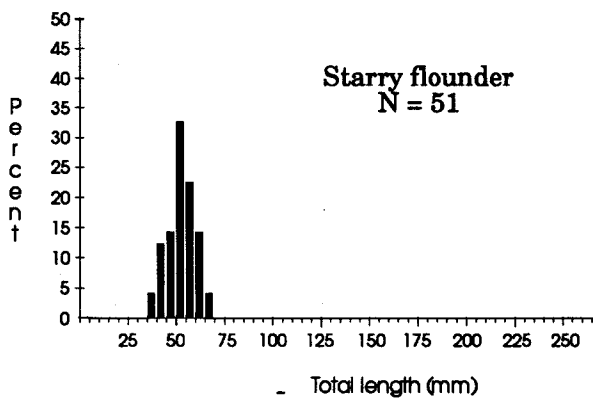
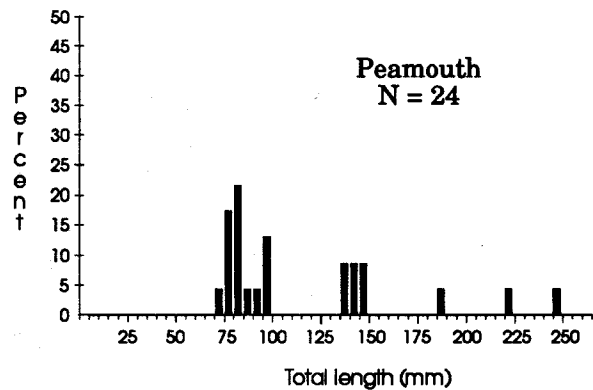
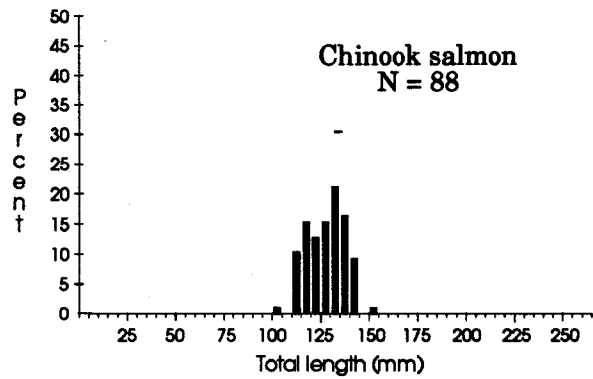
Proposed habitat restoration areaShallow subtidal habitat

Appendix Figure 2. Length-frequency distributions of abundant fishes collected in two areas between Miller Sands and Pillar Rock Island, Columbia River estuary, July 1992. N = the number of individuals measured.

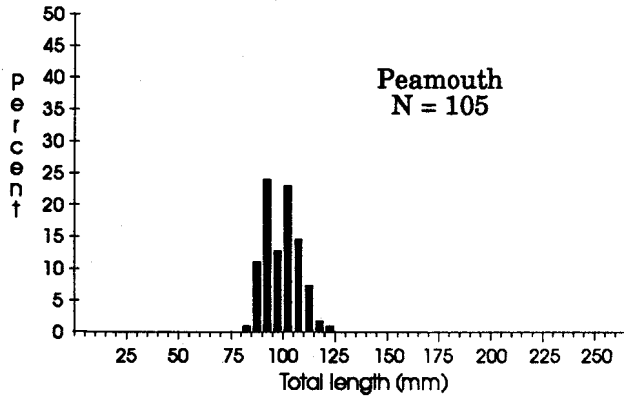
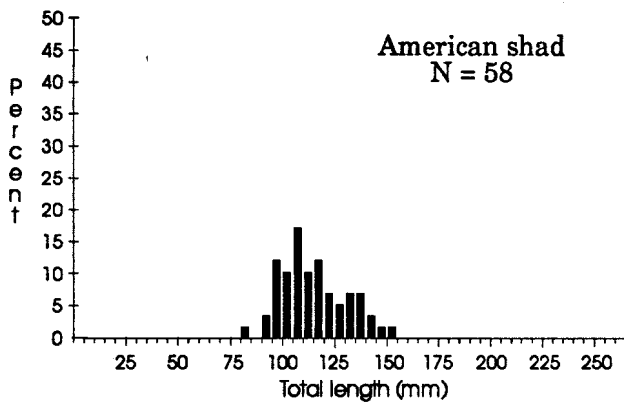
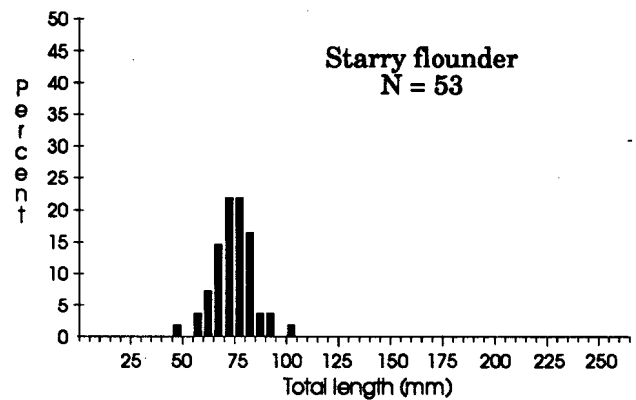
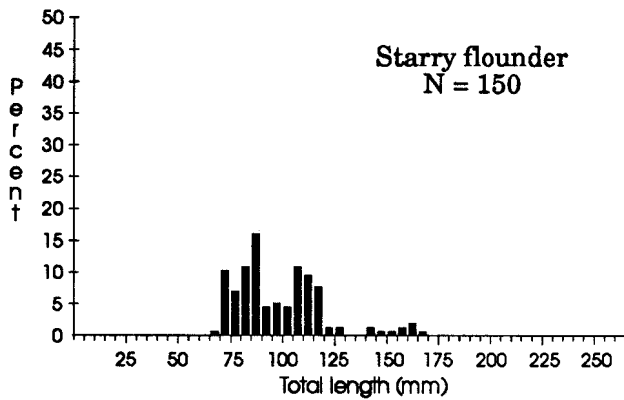
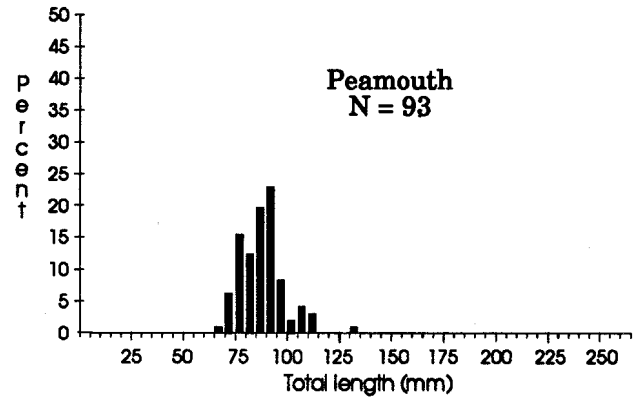
Proposed habitat restoration areaShallow subtidal habitat

Appendix Figure 3. Length frequency distributions of abundant fishes collected in two areas between Miller Sands and Pillar Rock Island, Columbia River estuary, September 1992. N = the number of individuals measured.

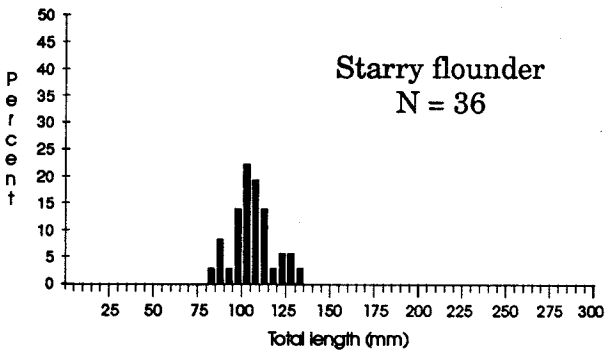
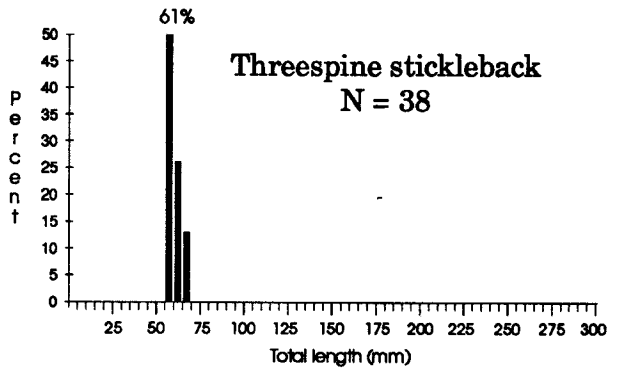
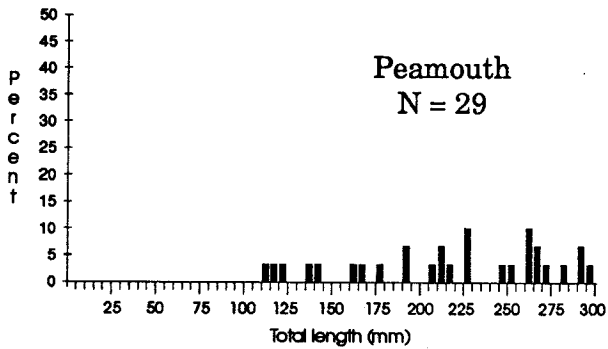
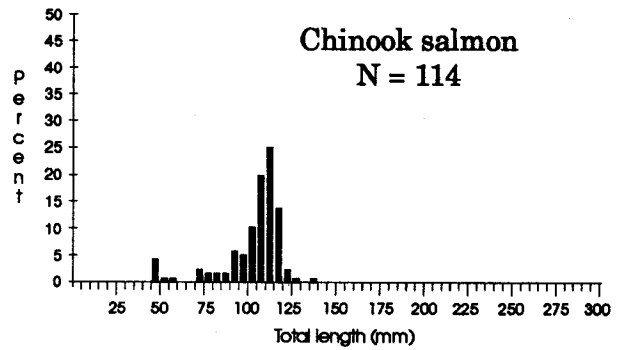
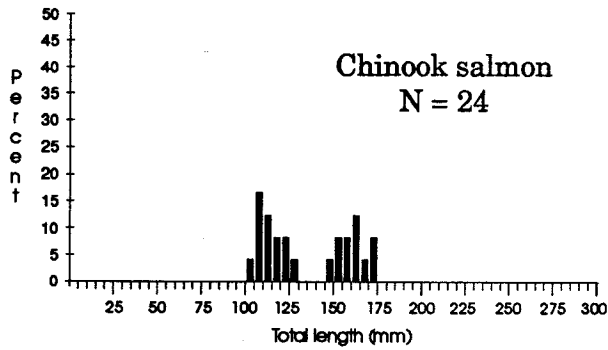
Proposed habitat restoration areaShallow subtidal habitat

Appendix Figure 4. Length-frequency distributions of abundant fishes collected in two areas between Miller Sands and Pillar Rock Island, Columbia River estuary, May 1993. N = the number of individuals measured.

Proposed habitat restoration area

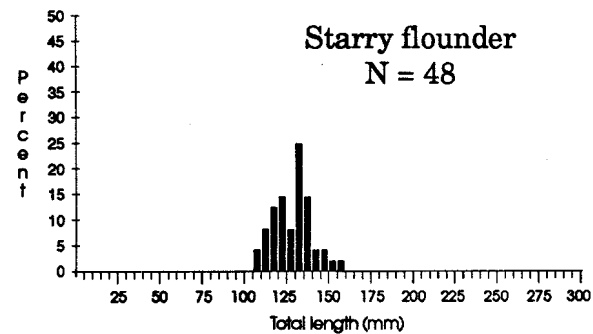
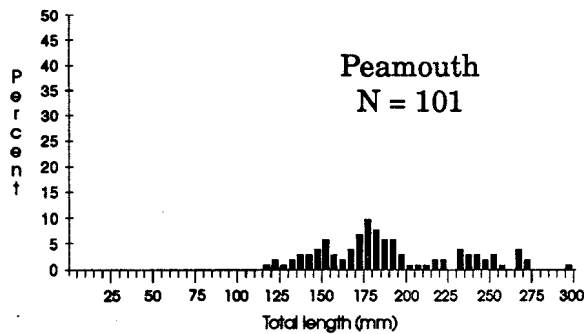
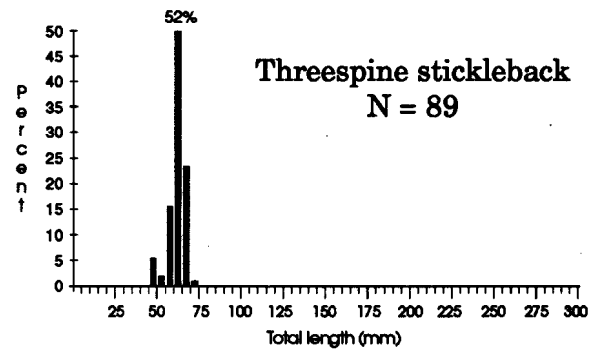
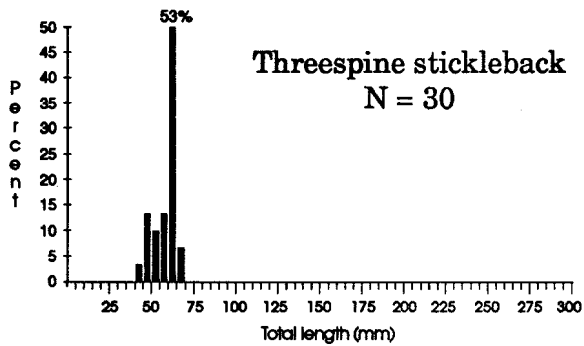
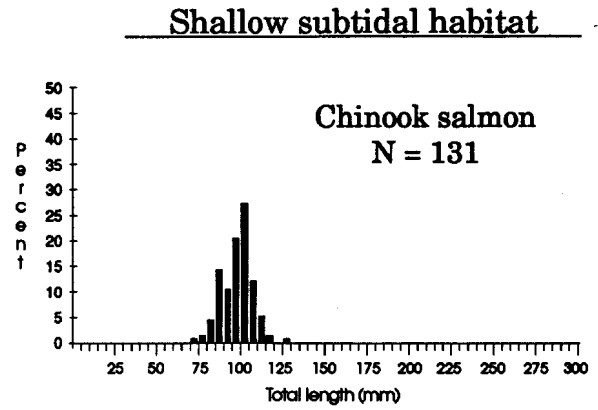
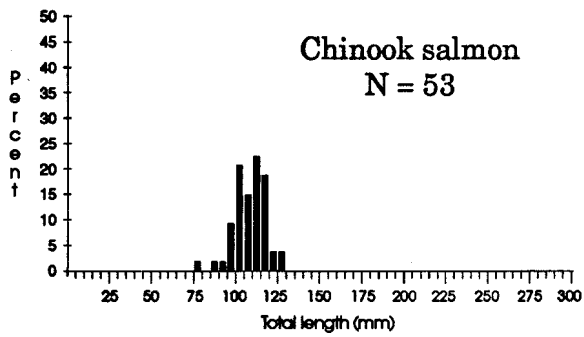

Appendix Figure 5. Length-frequency distributions of abundant fishes collected in two areas between Miller Sand and Pillar Rock Island, Columbia River estuary, July 1993. N = the number of individuals measured.

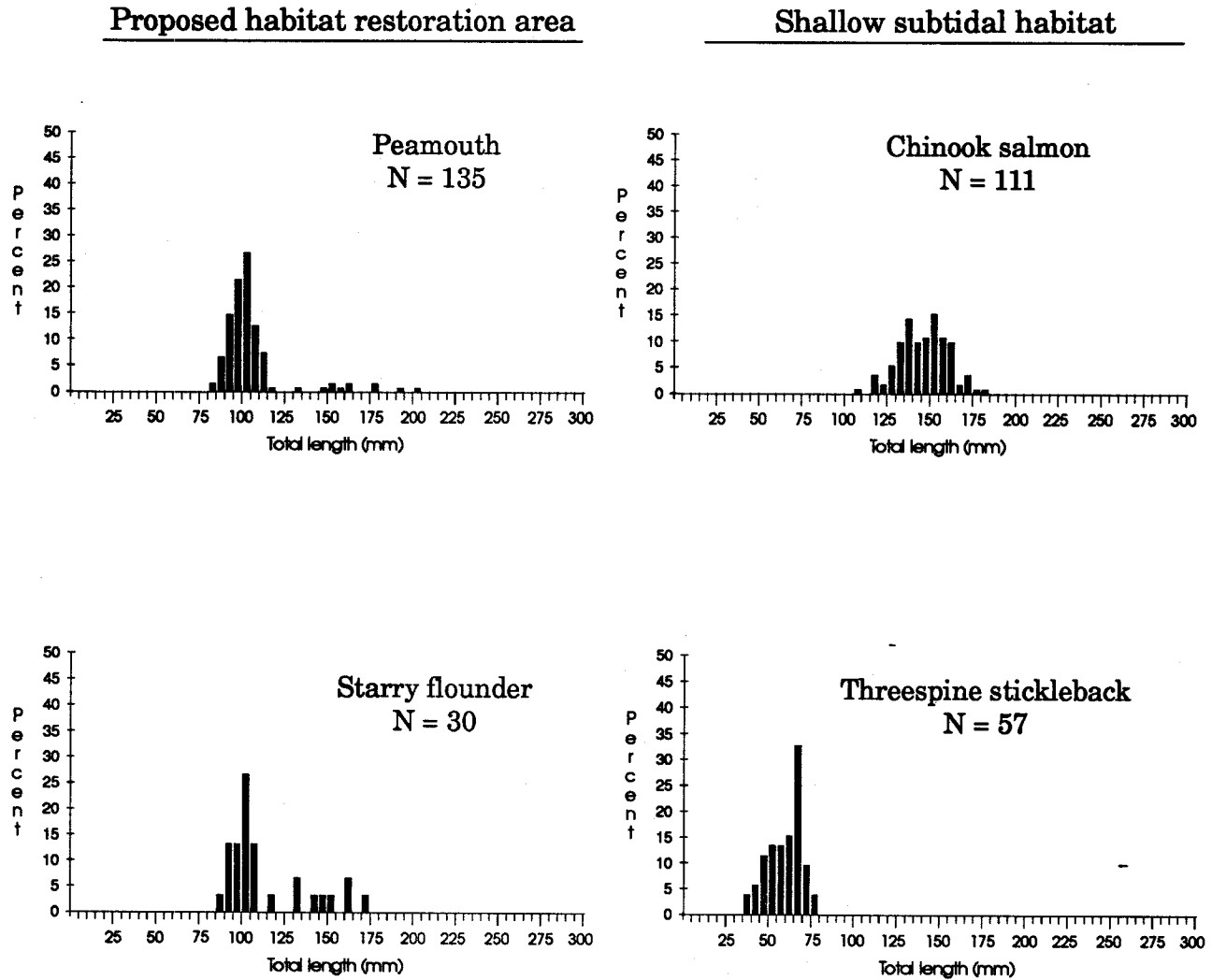

Appendix Figure 6. Length-frequency distributions of abundant fishes collected in two areas between Miller Sands and Pillar Rock Island, Columbia River estuary, September 1993. N = the number of individuals measured.

APPENDIX TABLES

Appendix Table 1. Station locations in a proposed habitat restoration area (Stations 1-10) and an adjacent shallow subtidal habitat (Stations 11-20) located between Miller Sands and Pillar Rock Island, Columbia River estuary, 1992 and 1993.

BENTHIC INVERTEBRATE AND SEDIMENT SAMPLING

Station	Mean depth (m) (mean lower low water)	Latitude	Longitude
1	8.6	46°15.305	123°37.254
2	9.6	15.301	37.024
3	9.6	15.297	36.795
4	10.1	15.290	36.565
5	10.7	15.283	36.335
6	7.1	15.126	37.276
7	7.6	15.149	37.047
8	6.9	15.171	36.808
9	7.6	15.190	36.569
10	5.3	15.208	36.330
11	0.5	46°14.896	123°37.276
12	1.8	14.929	37.038
13	2.3	14.959	36.802
14	2.9	14.989	36.572
15	1.5	15.022	36.341
16	0.3	14.799	37.274
17	0.7	14.829	37.036
18	2.3	14.862	36.802
19	2.9	14.896	36.564
20	0.7	14.922	36.335

FISH SAMPLING

Station	Mean depth (m) (mean lower low water)	Beginning Latitude	Beginning Longitude	Ending Latitude	Ending Longitude
<u>Trawling</u>					
TR1	9.1	46°15.279	123°37.908	46°15.280	123°36.412
TR1	8.2	15.228	37.994	15.239	36.520
TR3	7.6	15.156	37.024	15.176	36.582
TR4	2.1	15.866	36.726	14.907	36.413
<u>Purse Seining</u>					
PS1	8.5	46°15.216	123°37.157		
PS2	9.0	15.230	36.800		
PS3	9.8	15.238	36.411		
PS4	1.8	14.851	37.157		
PS5	3.4	14.903	36.800		
PS6	2.7	14.955	36.432		

Appendix Table 2. Invertebrate taxa/categories found in a proposed habitat restoration area and an adjacent shallow subtidal habitat located between Miller Sands and Pillar Rock Island, Columbia River, July and September 1992 and May, July, and September 1993.

Taxon/category	1992		1993		
	July	Sep	May	July	Sep
PROPOSED HABITAT RESTORATION AREA					
Nemertea				x	
Nematomorpha			x	x	
<i>Hydra</i> spp.	x				
Turbellaria		x	x	x	x
Polychaeta					
<i>Neanthes limnicola</i>	x	x			x
Oligochaeta	x	x	x	x	x
Oligochaeta egg cases					x
Gastropoda			x	x	
<i>Juga plicifera</i>			x		x
<i>Lithoglyphus virens</i>			x	x	x
Bivalvia					
<i>Corbicula fluminea</i>	x	x	x	x	x
Ostracoda			x		
Mysidacea					
<i>Neomysis mercedis</i>	x			x	
Amphipoda					
<i>Corophium</i> spp.			x		x
<i>Corophium salmonis</i>	x	x	x	x	x
<i>Corophium spinicorne</i>					x
<i>Pontoporeia hoyi</i>	x				
Isopoda					
<i>Porcellio scaber</i>	x				
<i>Saduria entomon</i>	x	x			
Cladocera	x	x			
<i>Daphnia</i> spp.	x	x			

Appendix Table 2. Continued.

Taxon/category	1992		1993		
	July	Sep	May	July	Sep
Copepoda	x	x			
Calanoida	x	x			
Cyclopoida	x				
Harpacticoida			x		
Insecta					
Diptera adult		x			
Chironomidae larvae	x	x	x	x	x
Chironomidae pupae	x		x		x
Chironomidae adult	x				
Ceratopogonidae				x	
Ceratopogonidae larvae	x	x	x	x	x
Collembola	x				x
Ephemeroptera			x		
Lepidoptera				x	
Odonata					x
Coleoptera larvae					x
Miscellaneous					
Arachnida	x	x	x		x
Total no. of taxa/categories	20	14	16	13	17

SHALLOW SUBTIDAL HABITAT

Nematomorpha			x	x	
<i>Hydra</i> spp.	x				
Turbellaria	x	x	x	x	x
Polychaeta					
<i>Neanthes limnicola</i>	x	x	x	x	x
Oligochaeta	x	x	x	x	x
Oligochaeta egg cases	x	x			x
Gastropoda			x	x	
<i>Juga plicifera</i>	x	x	x	x	x
<i>Lithoglyphus virens</i>	x	x	x	x	x
Bivalvia					
<i>Corbicula fluminea</i>	x	x	x	x	x

Appendix Table 2. Continued.

Taxon/category	1992		1993		
	July	Sep	May	July	Sep
Ostracoda	x	x	x	x	x
Mysidacea					
<i>Neomysis mercedis</i>		x			
Amphipoda					
<i>Corophium</i> spp.			x	x	
<i>Corophium salmonis</i>	x	x	x	x	x
<i>Corophium spinicorne</i>				x	x
<i>Pontoporeia hoyi</i>	x	x	x	x	
Cladocera	x				
<i>Daphnia</i> spp.	x	x			
Copepoda	x	x			
Calanoida	x	x			
Cyclopoida	x				
Harpacticoida			x		
Insecta					
Diptera adult	x				
Odonata		x	x		
Chironomidae larvae	x	x	x	x	x
Chironomidae pupae	x		x	x	x
Ceratopogonidae	x				
Ceratopogonidae larva	x	x	x	x	x
Coleoptera larvae			x		
Miscellaneous					
Hydracarina				x	
Arachnida	x	x	x		x
Total no. of taxa/categories	22	18	19	17	14

Appendix Table 3. Fish and shrimp taxa found in a proposed habitat restoration area and an adjacent shallow subtidal habitat located between Miller Sands and Pillar Rock Island, Columbia River estuary, July and September 1992 and May, July, and September 1993.

Scientific name	Common name	1992		1993		
		July	Sep	May	July	Sep
Petromyzontidae	Unidentified lamprey			x		
Acipenseridae						
<i>Acipenser transmontanus</i>	White sturgeon			x	x	x
Clupeidae						
<i>Alosa sapidissima</i>	American shad	x	x	x		x
Cyprinidae						
	Unidentified cyprinid	x				
<i>Mylocheilus caurinus</i>	Peamouth	x	x	x	x	x
<i>Ptychocheilus oregonensis</i>	Northern squawfish	x				x
Catostomidae						
<i>Catostomus macrocheilus</i>	Largescale sucker			x		
Salmonidae						
<i>Oncorhynchus kisutch</i>	Coho salmon			x		x
<i>Oncorhynchus nerka</i>	Sockeye salmon			x		
<i>Oncorhynchus tshawytscha</i>	Chinook salmon	x	x	x	x	x
<i>Oncorhynchus mykiss</i>	Rainbow trout (steelhead)			x		
Cyprinodontidae						
<i>Fundulus diaphanus</i>	Banded killifish				x	
Gasterosteidae						
<i>Gasterosteus aculeatus</i>	Threespine stickleback	x	x	x	x	x
Cottidae						
	Unidentified sculpin	x	x		x	x
<i>Cottus asper</i>	Prickly sculpin	x	x	x	x	x
<i>Leptocottus armatus</i>	Pacific staghorn sculpin	x	x	x	x	x
Pleuronectidae						
<i>Platichthys stellatus</i>	Starry flounder	x	x	x	x	x
Crangonidae						
<i>Crangon franciscorum</i>	California bay shrimp	x	x			x
Total		11	9	13	9	12