

WELL NO. A5
 PUMP CAPACITY 355 GPM
 WELL YIELD 150 GPM
 DATE INSTALLED 1942

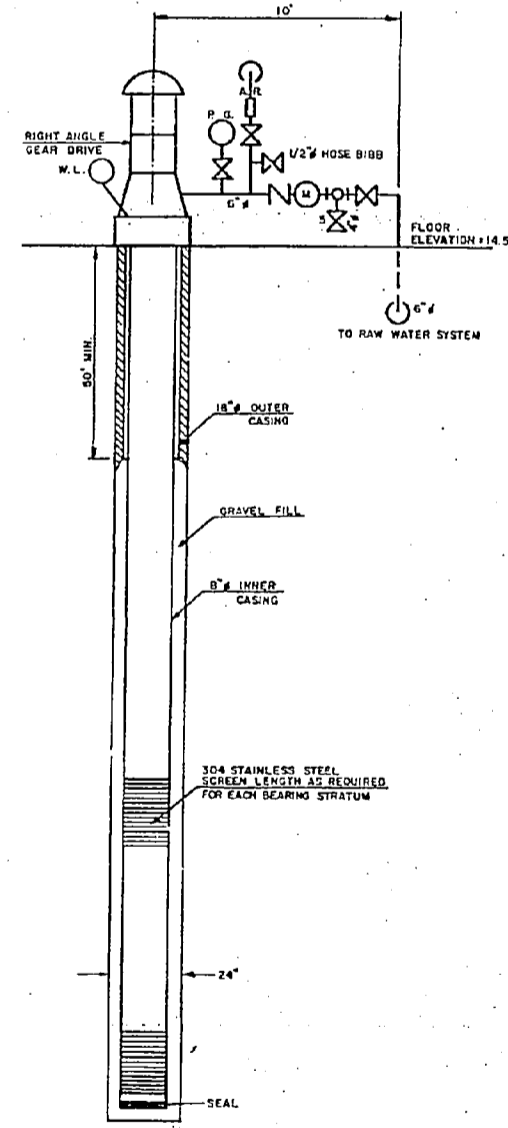

WELL NO. BB 47
 PUMP CAPACITY 330 GPM
 WELL YIELD 300 GPM
 DATE INSTALLED 1942

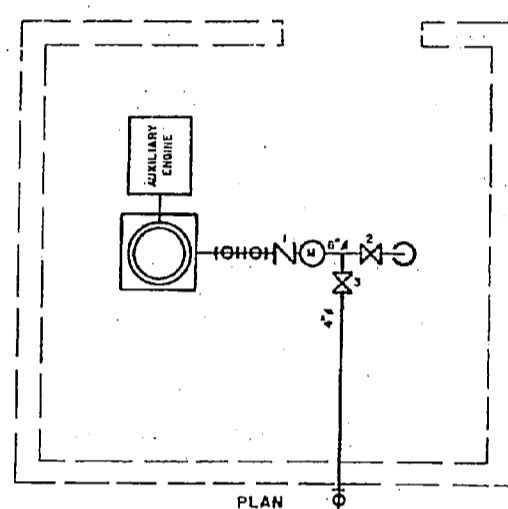
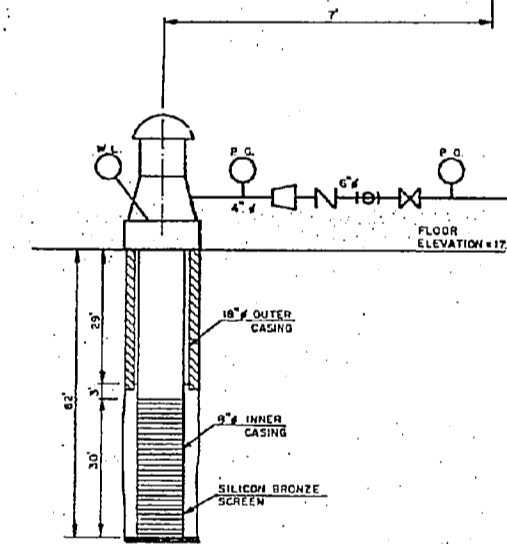
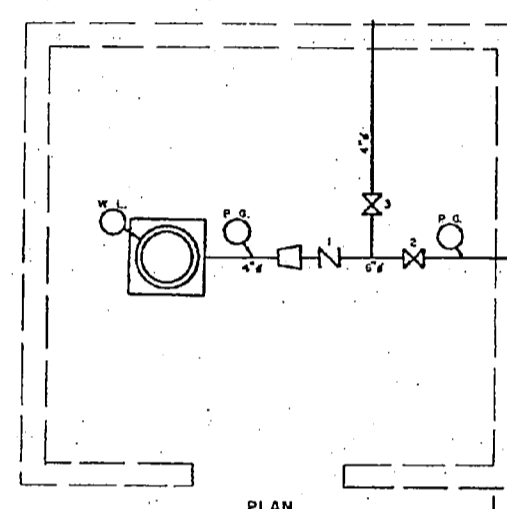

WELL NO. BB 44
 PUMP CAPACITY 190 GPM
 WELL YIELD 200 GPM
 DATE INSTALLED 1942

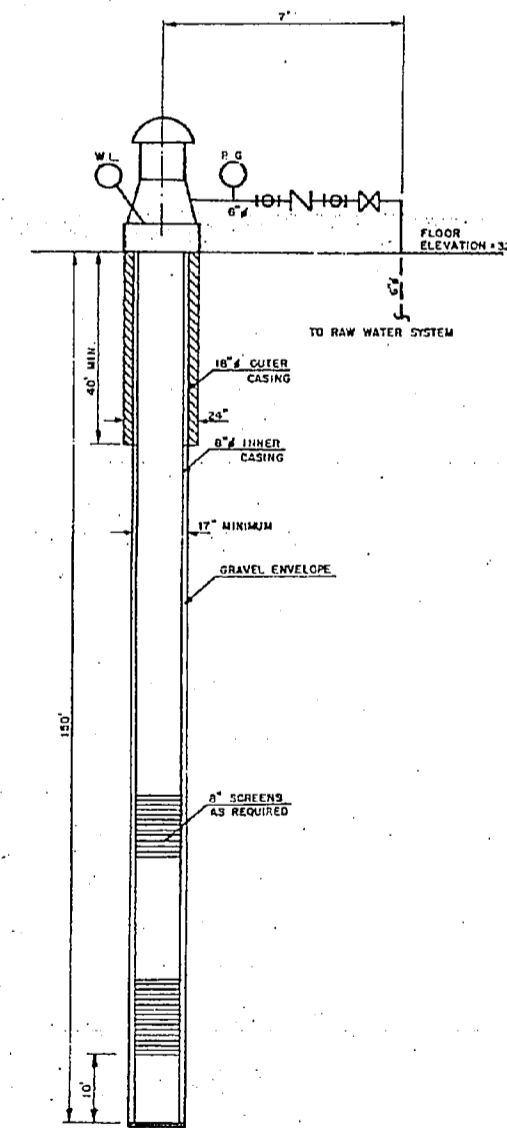
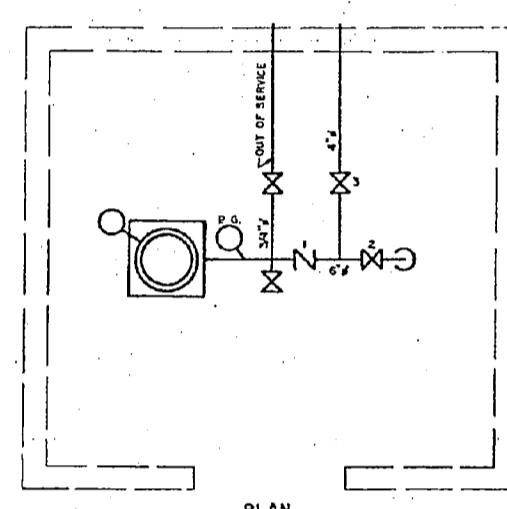

WELL NO. BB 220
 PUMP CAPACITY 180 GPM
 WELL YIELD 10.5 GPM
 DATE INSTALLED 1974

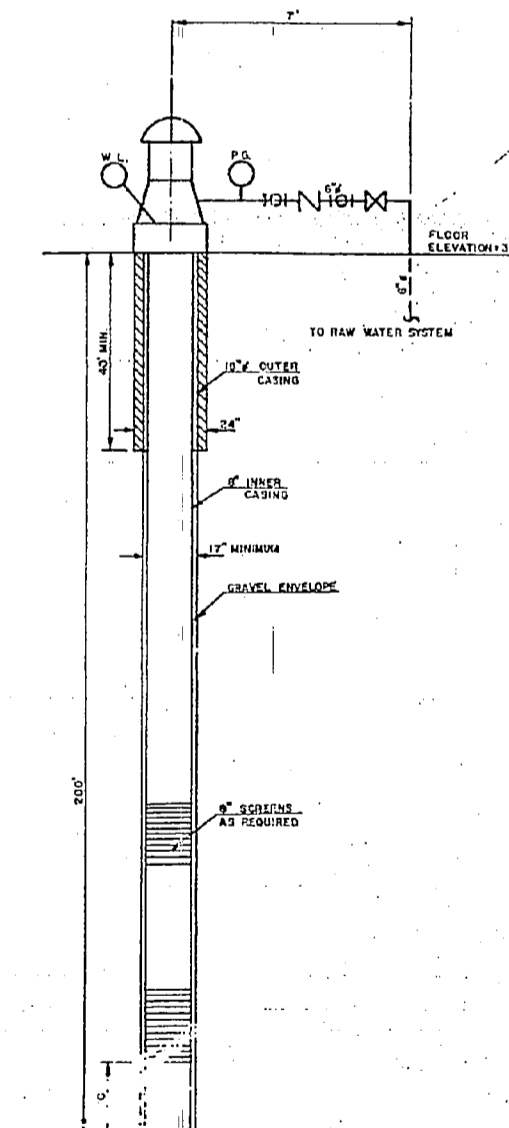
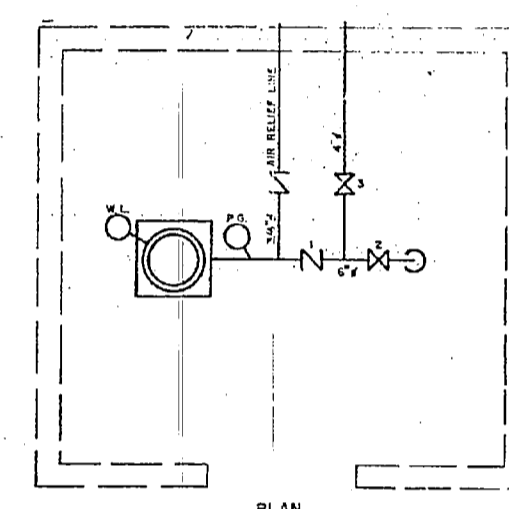

WELL NO. BB 221
 PUMP CAPACITY 300 GPM
 WELL YIELD 240 GPM
 DATE INSTALLED 1974

- LEGEND
- VALVE NO. 6
 - GATE VALVE
 - CHECK VALVE
 - BUTTERFLY VALVE
 - REDUCER
 - CAPPED END
 - METER
 - ALTITUDE VALVE
 - BACK PRESSURE CONTROL VALVE
 - PRESSURE GAGE
 - AIR RELEASE VALVE
 - WATER LEVEL INDICATOR
 - WELL SCREEN
 - CONCRETE WELL PLUG
 - CONCRETE WELL SEAL

NO.	DESCRIPTION OF REVISION	DATE	INT.
DEPARTMENT OF THE NAVY MARINE CORPS BASE CAMP LEJEUNE, NORTH CAROLINA			
WATER WELLS COURTHOUSE BAY SYSTEM EXISTING CONDITIONS			
DATE 31 AUG 84	SCALE: NONE	SHEET 20	of 21
APPROVED / DATE		0000124	

100

100

100

100

100

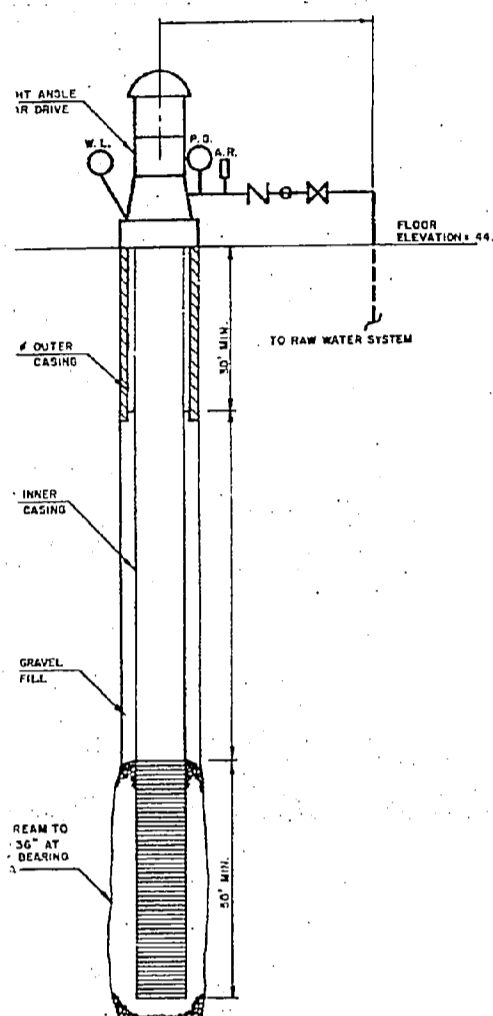
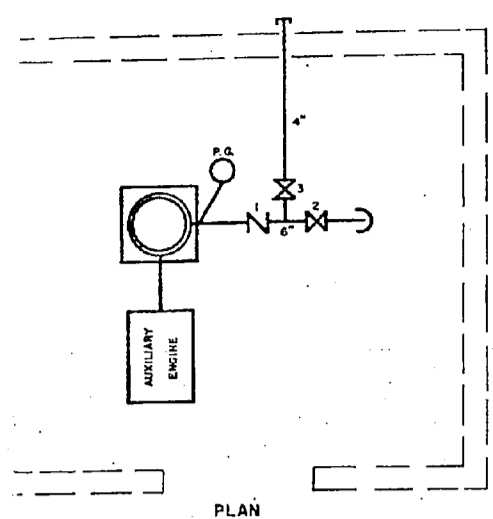

WELL NO. BB
 PUMP CAPACITY 300 GPM
 WELL YIELD _____
 DATE INSTALLED 1984

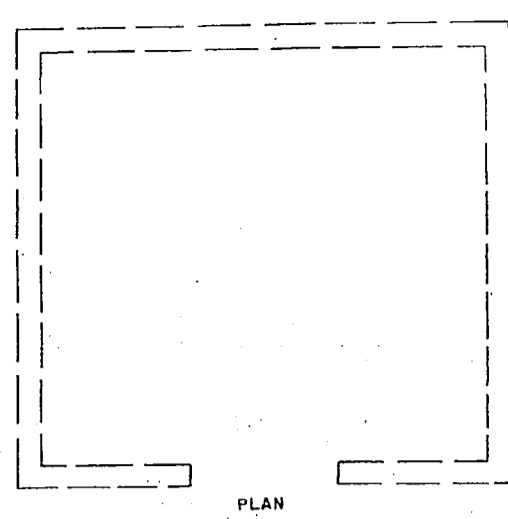

FLOOR ELEVATION: _____

ELEVATION

WELL NO. _____
 PUMP CAPACITY _____
 WELL YIELD _____
 DATE INSTALLED _____

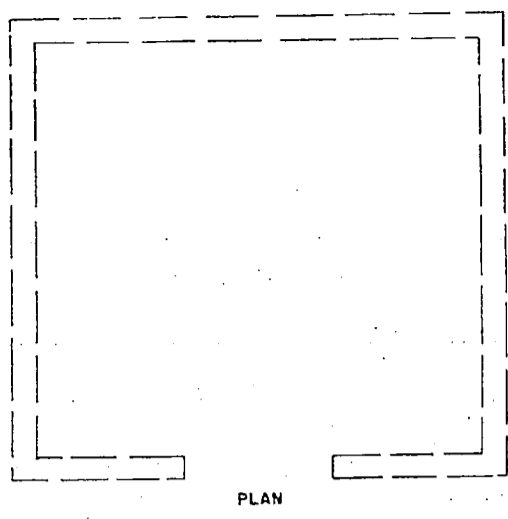

FLOOR ELEVATION: _____

ELEVATION

WELL NO. _____
 PUMP CAPACITY _____
 WELL YIELD _____
 DATE INSTALLED _____

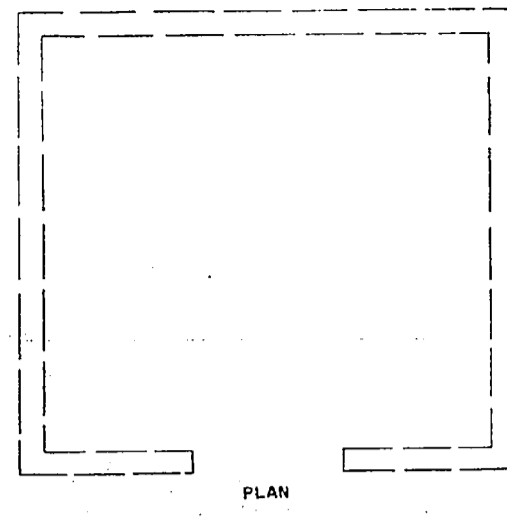

FLOOR ELEVATION: _____

ELEVATION

WELL NO. _____
 PUMP CAPACITY _____
 WELL YIELD _____
 DATE INSTALLED _____

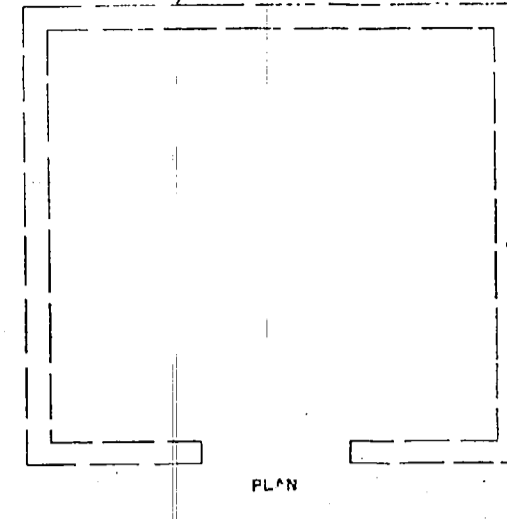

FLOOR ELEVATION: _____

ELEVATION

WELL NO. _____
 PUMP CAPACITY _____
 WELL YIELD _____
 DATE INSTALLED _____

- LEGEND
- VALVE NO. 0
 - GATE VALVE
 - CHECK VALVE
 - BUTTERFLY VALVE
 - PNEUMATIC
 - CAPPED END
 - METER
 - AIR VALVE
 - BACK PRESSURE CONTROL VALVE
 - PRESSURE GAUGE
 - AIR RELEASE VALVE
 - WATER LEVEL INDICATOR
 - WELL SCREEN
 - CONCRETE WELL PLUG
 - CONCRETE WELL SEAL

NO.	DESCRIPTION OF REVISION	DATE	INT.

DEPARTMENT OF THE NAVY
 MARINE CORPS BASE
 CAMP LEJEUNE, NORTH CAROLINA

WATER WELLS
 COURTHOUSE BAY SYSTEM
 EXISTING CONDITIONS

DATE 31 AUG 84 SCALE NONE SHEET 20A of 21

APPROVED: DATE 0000125

100

100

100

100

100

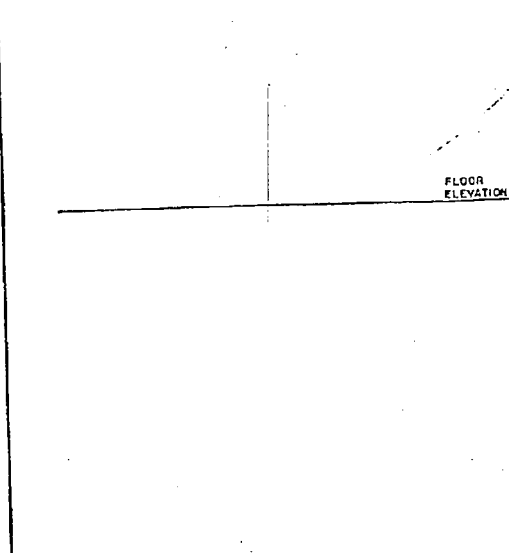
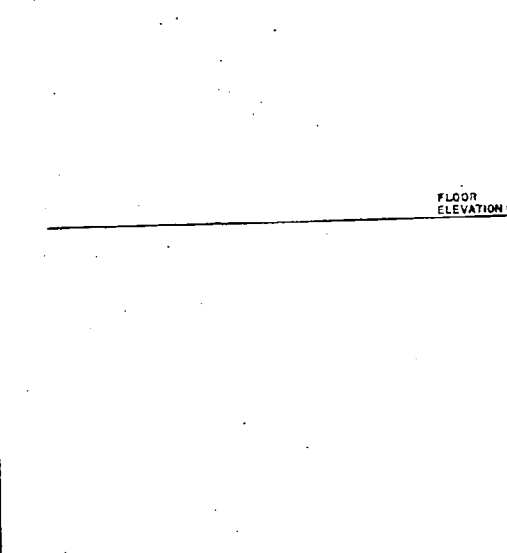
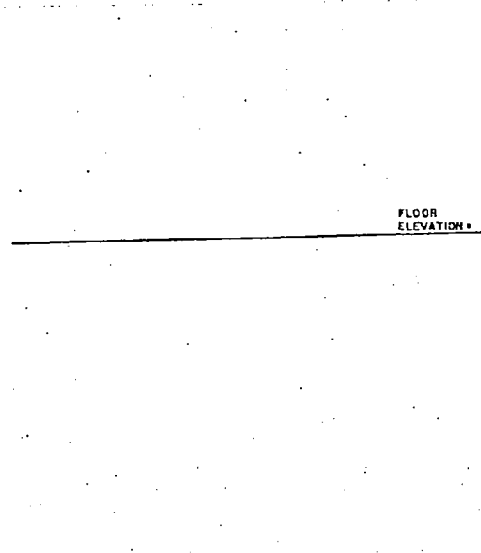
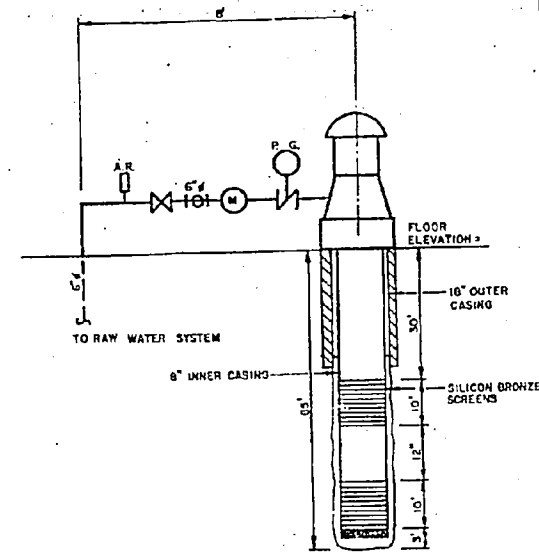
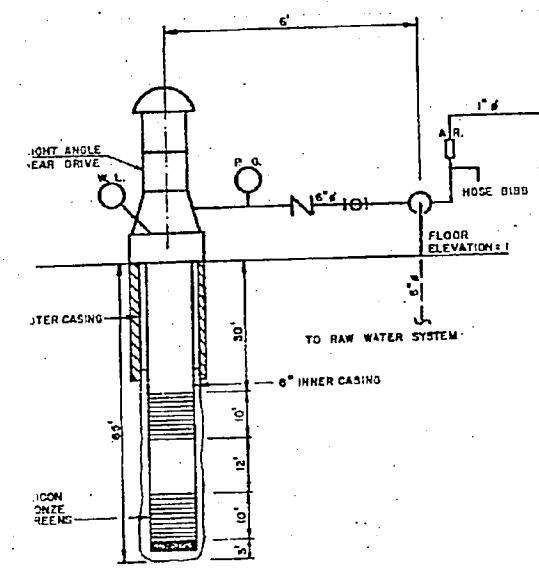
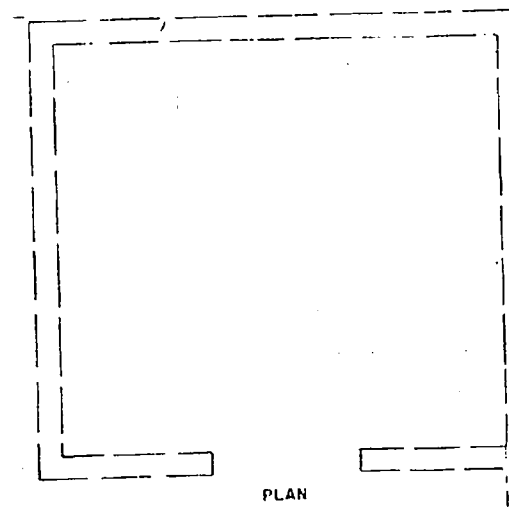
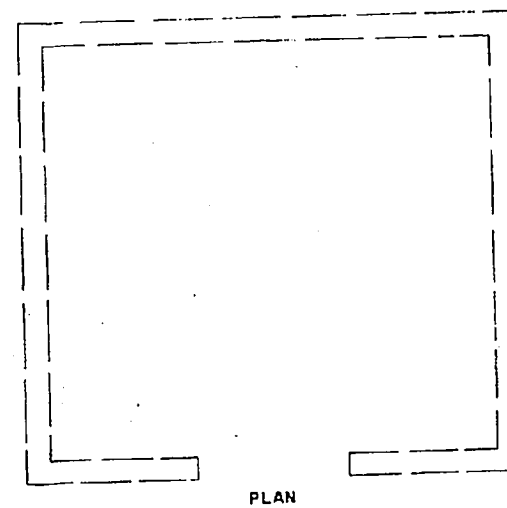
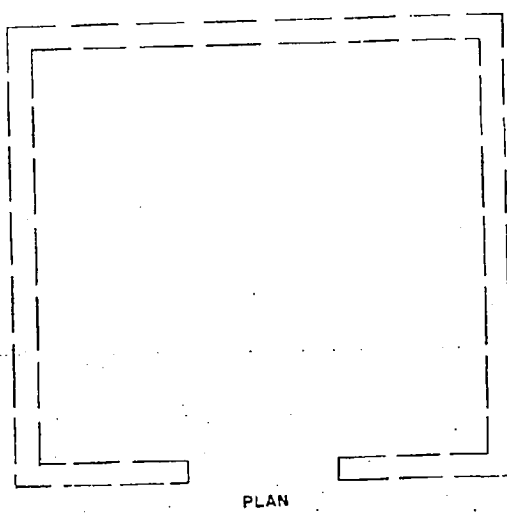
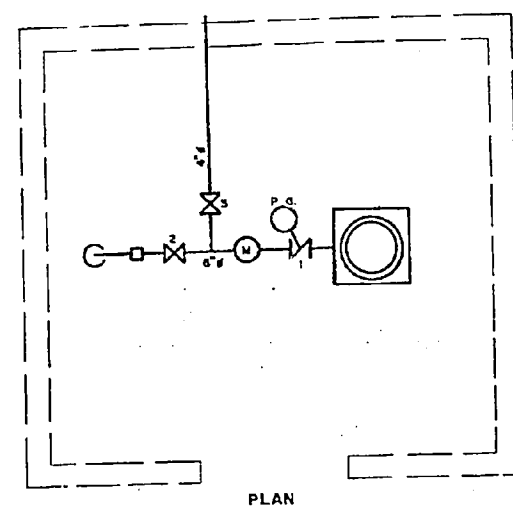
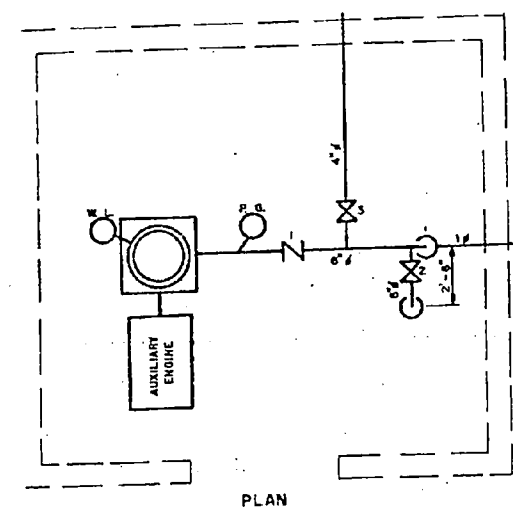

WELL NO. BA164
 PUMP CAPACITY 275 GPM
 WELL YIELD 1.15
 DATE INSTALLED

WELL NO. BA190
 PUMP CAPACITY 250 GPM
 WELL YIELD 280 GPM
 DATE INSTALLED 1978

WELL NO. _____
 PUMP CAPACITY _____
 WELL YIELD _____
 DATE INSTALLED _____

WELL NO. _____
 PUMP CAPACITY _____
 WELL YIELD _____
 DATE INSTALLED _____

WELL NO. _____
 PUMP CAPACITY _____
 WELL YIELD _____
 DATE INSTALLED _____

- LEGEND
- VALVE NO. 0
 - GATE VALVE
 - CHECK VALVE
 - BUTTERFLY VALVE
 - REDUCER
 - GAPPED END
 - METER
 - ALTITUDE VALVE
 - BACK PRESSURE CONTROL VALVE
 - PRESSURE GAGE
 - AIR RELEASE VALVE
 - WATER LEVEL INDICATOR
 - WELL SCREEN
 - CONCRETE WELL PLUG
 - CONCRETE WELL SEAL

NO.	DESCRIPTION OF REVISION	DATE	INT.

DEPARTMENT OF THE NAVY
 MARINE CORPS BASE
 CAMP LEJEUNE, NORTH CAROLINA

WATER WELLS
 ONSLOW BEACH SYSTEM
 EXISTING CONDITIONS

DATE 31 AUG 84 SCALE NONE SHEET 21 of 21
 APPROVED / DATE 0000126

00 FC440-024-011