

## FILE FOLDER

### DESCRIPTION ON TAB:

Pesticides

---

---

---



**Outside/inside of actual folder did not contain hand written information**



**Outside/inside of actual folder did contain hand written information**

**\*Scanned as next image**

# North Carolina Pesticide Law of 1971

*(Article 52, Chapter 143; §66-57, Article 10 of Chapter 66;  
of the General Statutes of North Carolina  
as amended in 1975, 1977, and 1979.)*



Published by  
N. C. DEPARTMENT OF AGRICULTURE

JAMES A. GRAHAM, *Commissioner*  
WILLIAM G. PARHAM, JR., *Deputy Commissioner*  
WILLIAM A. WILDER, JR., *Assistant Commissioner*

PESTICIDE AND PLANT PROTECTION DIVISION

ALFRED S. ELDER, *Director*  
RALEIGH, N. C.

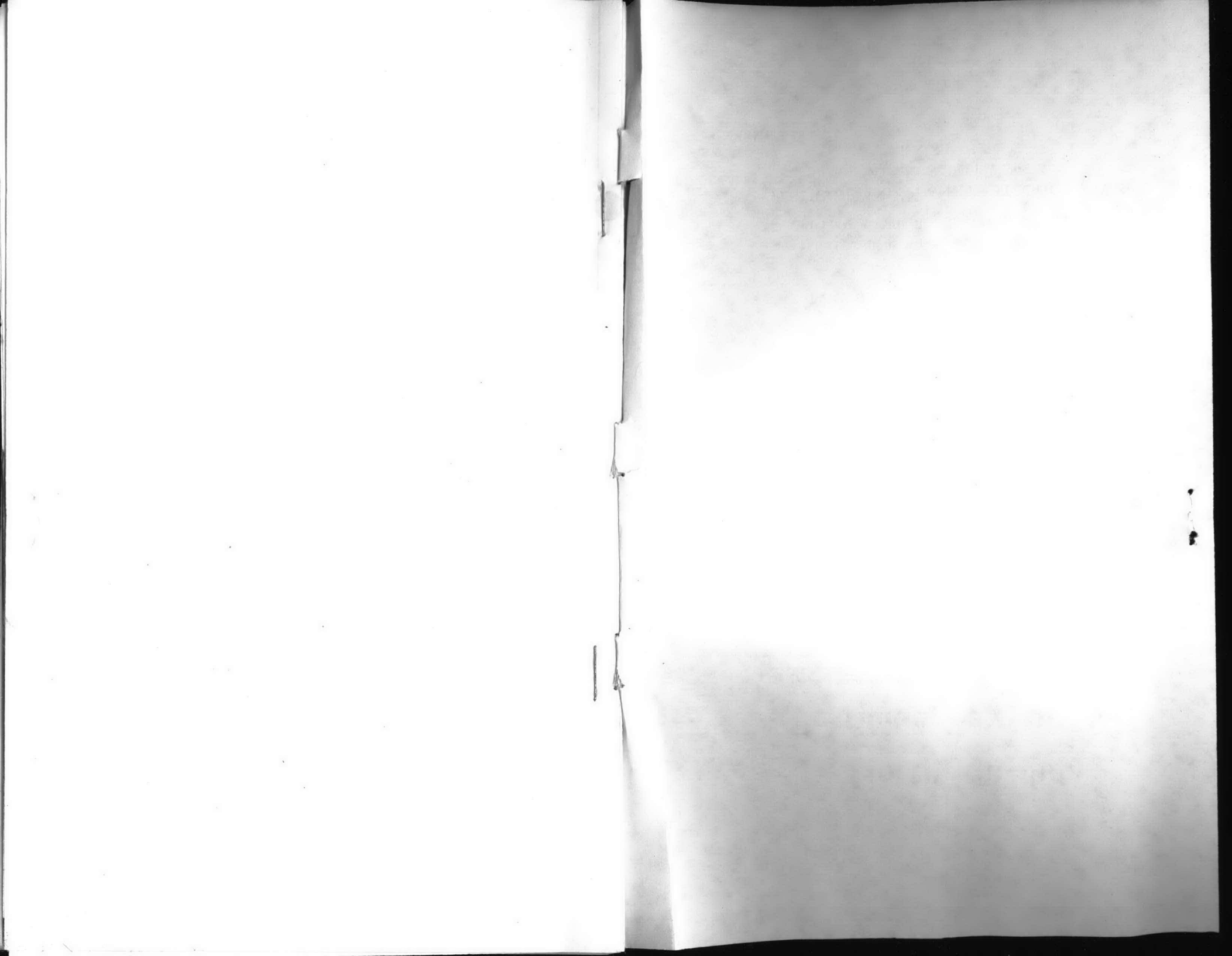

## TABLE OF CONTENTS

### North Carolina Pesticide Law of 1971

(Article 52 of Chapter 143 of the General Statutes of North Carolina)

#### Sections

- 143-434 Short Title.
- 143-435 Preamble.
- 143-436 North Carolina Pesticide Board; creation and organization.
- 143-437 Pesticide Board; functions.
- 143-438 Commissioner of Agriculture to administer and enforce Article.
- 143-439 Pesticide Advisory Committee; creation and functions.
- 143-440 Restricted-use pesticides regulated.
- 143-441 Handling, storage and disposal of pesticides.
- 143-442 Registration.
- 143-443 Miscellaneous prohibited acts.
- 143-444 Determinations.
- 143-445 Exemptions.
- 143-446 Samples; submissions.
- 143-447 Emergency suspensions; seizures.
- 143-448 Licensing of pesticide dealers; fees.
- 143-449 Qualifications for pesticide dealer license; examinations.
- 143-450 Employees of pesticide dealers; dealer's responsibility.
- 143-451 Denial, suspension, and revocation of license.
- 143-452 Licensing of pesticide applicators; fees.
- 143-453 Qualifications for pesticide applicator's license; examinations.
- 143-454 Solicitors, salesmen and operators; applicator's responsibility.
- 143-455 Pest control consultant license.
- 143-456 Denial, suspension, and revocation of license.
- 143-457 Damaged person must file report of loss; contents; time for filing; effect of failure to file.
- 143-458 Rules and regulations concerning methods of application.
- 143-459 Reporting of shipments and volumes of pesticides.
- 143-460 Definitions.

#### Sections — (continued)

- 143-461 General powers of Board.
- 143-462 Procedures for revocations and related actions affecting licenses.
- 143-463 Procedures for adoption of certain rules and regulations; publication of rules and regulations.
- 143-464 Procedures with respect to registration of pesticides and certain other matters; mailing list; seal; judicial review.
- 143-465 Reciprocity; intergovernmental cooperation.
- 143-466 Records; information; inspections; enforcement.
- 143-467 Financial responsibility.
- 143-468 Disposition of fees.
- 143-469 Penalties.
- 143-470 Provisional or interim licenses.

#### FAIR TRADE

(Article 10 of Chapter 66 of the General Statutes of North Carolina)

- 66-57 Exemptions.

TABLE OF CONTENTS

North Carolina Part

Introduction

Chapter I

Chapter II

Chapter III

Chapter IV

Chapter V

Chapter VI

Chapter VII

Chapter VIII

Chapter IX

Chapter X

Chapter XI

Chapter XII

Chapter XIII

Chapter XIV

Chapter XV

Chapter XVI

Chapter XVII

Chapter XVIII

Chapter XIX

Chapter XX

Chapter XXI

Chapter XXII

Chapter XXIII

Chapter XXIV

Chapter XXV

Chapter XXVI

Chapter XXVII

Chapter XXVIII

Chapter XXIX

Chapter XXX

# NORTH CAROLINA PESTICIDE LAW OF 1971

## CHAPTER 143, ARTICLE 52

### Pesticide Board

#### Part 1. Pesticide Control Program: Organization and Functions.

§143-434. **Short Title.**—This Article may be cited as the North Carolina Pesticide Law of 1971. (1971, c. 832, s. 1.)

§143-435. **Preamble.**—(a) The Legislative Research Commission was directed by House Resolution 1392 of the 1969 General Assembly "to study agricultural and other pesticides," and to report its findings and recommendations to the 1971 General Assembly. Pursuant to said Resolution a report was prepared and adopted by the Legislative Research Commission in 1970 concerning pesticides. In this report the Legislative Research Commission made the following findings concerning the use and effects of pesticides and the need for legislation concerning control of pesticide use, of which the General Assembly hereby takes cognizance:

- (1) The use of chemical pesticides has developed since the 1940's into a major, new billion-dollar industry. Pesticides have bettered the lot of mankind in many ways and especially have assisted the farmer by their contribution to a stable and inexpensive supply of high quality food, fiber and forest products. The control of insects, fungi and other pests is essential to the public health and welfare and specifically to the prevention of disease, to the production and preservation of food, fiber, and forests and to the protection of other aspects of modern civilization.
- (2) The use of pesticides for these important purposes is currently a matter of serious public concern and their use in some instances presents risks to man and the environment which must be weighed against the benefits of those uses in the overall public interest. Evidence is accumulating that extensive use of persistent pesticides poses hazards to health and the environment. Environmental problems resulting from the use, overuse and misapplication of some chemicals, and the disposal of unused chemicals and containers, have grown to the point where contamination of the environment is approaching significant proportions. There is concern among scientists and public health personnel about the long-term chronic effects of pesticide pollution on human health. Contamination by DDT has been shown to be global in extent. Moreover, recent experience in North Carolina and elsewhere has shown that the more toxic but less persistent pesticides cannot safely be substituted for the persistent "hard" pesticides without stringent safeguards.
- (3) More extensive observation, study and monitoring of the effectiveness and the use of pesticides and of undesirable side effects on man and on the environment and of their relative importance for the overall public health and welfare are desirable in the public interest.
- (4) Continued and strengthened control of the quality of pesticides and the control of labeling claims, direction for use and warnings are necessary for the protection of the purchasing public, including the household consumer, the farmer and other users.
- (5) No existing legislation in North Carolina effectively limits or controls the use of pesticides. Misuse and misapplication of pesticides, while effectively

controlled by law with respect to structural pest control operators, is not adequately controlled with respect to some other major groups of pesticide applicators. Careless disposal of unused pesticides and contaminated containers is not controlled by law, and no North Carolina legislation requires that pesticide dealers, who are the principal source of advice for many pesticide users, be qualified to give advice or be held responsible for their advice. These gaps in legal control of pesticides are important and should be remedied.

(b) The purpose of this Article is to regulate in the public interest the use, application, sale, disposal and registration of insecticides, fungicides, herbicides, defoliants, desiccants, plant growth regulators, nematocides, rodenticides, and any other pesticides designated by the North Carolina Pesticide Board. New pesticides are continually being discovered or synthesized which are valuable for the control of insects, fungi, weeds, nematodes, rodents, and for use as defoliants, desiccants, plant growth regulators and related purposes. However, such pesticides may be ineffective or may seriously injure health, property, or wildlife if not properly used. Pesticides may injure man or animals, either by direct poisoning or by gradual accumulation of poisons in the tissues. Crops or other plants may also be injured by their improper use. The drifting or washing of pesticides into streams or lakes can cause appreciable danger to aquatic life. A pesticide applied for the purpose of killing pests in a crop, which is not itself injured by the pesticide, may drift and injure other crops or nontarget organisms with which it comes in contact. In furtherance of the findings and recommendations of the Legislative Research Commission, it is hereby declared to be the policy of the State of North Carolina that for the protection of the health, safety, and welfare of the people of this State, and for the promotion of a more secure, healthy and safe environment for all the people of the State, the future sale, use and application of pesticides shall be regulated, supervised and controlled by the State in the manner herein provided. (1971, c. 832, s. 1.)

§143-436. **North Carolina Pesticide Board; creation and organization.**—(a) There is hereby established the North Carolina Pesticide Board which, together with the Commissioner of Agriculture, shall be responsible for carrying out the provisions of this Article.

(b) The Pesticide Board shall consist of seven members, to be appointed by the Governor, as follows:

- (1) One member each representing the North Carolina Department of Agriculture, the North Carolina Department of Human Resources, and a State conservation agency. The persons so selected may be either members of a policy board or departmental officials or employees.
- (2) A representative of the agricultural chemical industry.
- (3) A person directly engaged in agricultural production.
- (4) Two at-large members, from fields of endeavor other than those enumerated in subdivisions (2) and (3) of this subsection, one of whom shall be a nongovernmental conservationist.

(c) The members of the Pesticide Board shall serve staggered four-year terms. Of the persons originally appointed, the members representing State agencies shall serve two-year terms, and the four at-large members shall serve four-year terms. All members shall hold their offices until their successors are appointed and qualified. Any vacancy occurring in the membership of the Board prior to the expiration

Faint, illegible text in the top left corner of the left page.

Faint, illegible text in the top left corner of the right page.

Faint, illegible text in the bottom left corner of the right page.

of the term shall be filled by appointment by the Governor for the remainder of the unexpired term. The Governor may at any time remove any member from the Board for gross inefficiency, neglect of duty, malfeasance, misfeasance or nonfeasance in office. Each appointment to fill a vacancy in the membership of the Board shall be of a person having the same credentials as his predecessor.

(d) The Board shall select its chairman from its own membership, to serve for a term of two years. The chairman shall have a full vote. Any vacancy occurring in the chairmanship shall be filled by the Board for the remainder of the term. The Board may select such other officers as it deems necessary.

(e) Any action of the Board shall require at least four concurring votes.

(f) The members of the Board who are not officers or employees of the State shall receive for their services the per diem and compensation prescribed in G.S. 138-5. (1971, c. 832, s. 1; 1973, c. 476, s. 128.)

**§143-437. Pesticide Board; functions.**—The Pesticide Board shall be the governing board for the programs of pesticide management and control set forth in this Article. The Pesticide Board shall have the following powers and duties under this Article:

- (1) To adopt rules and regulations and make policies for the programs set forth in this Article.
- (2) To carry out a program of planning, environmental and biological monitoring, and of investigation into long-range needs and problems concerning pesticides.
- (3) To collect, analyze and disseminate information necessary for the effective operation of the programs set forth in this Article.
- (4) To provide professional advice to public and private agencies and citizens of the State on matters relating to pesticides, in cooperation with other State agencies, with professional groups, and with North Carolina State University and other educational institutions.
- (5) To accept gifts, devises and bequests, and with the approval of the Governor to apply for and accept grants from the Federal Government and its agencies and from any foundation, corporation, association or individual, and may comply with the terms, conditions and limitations of the grant, in order to accomplish any of the purposes of the Board, such grant funds to be expended pursuant to the Executive Budget Act.
- (6) To inform and advise the Governor on matters involving pesticides, and to prepare and recommend to the Governor and the General Assembly any legislation which may be deemed proper for the management and control of pesticides in North Carolina.
- (7) To make annual reports to the Governor and to make such other investigations and reports as may be requested by the Governor or the General Assembly.
- (8) To exempt any federal or State agency from any provision of this Article if it is determined by the Board that emergency conditions exist which require exemption. (1971, c. 832, s. 1; 1977, c. 199; 1979, c. 448, s. 14.)

**§143-438. Commissioner of Agriculture to administer and enforce Article.**—The Commissioner of Agriculture shall have the following powers and duties under this Article:

- (1) To administer and enforce the provisions of this Article.
- (2) To attend all meetings of the Pesticide Board, but without power to vote (unless he be designated as the ex officio member of the Board from the Department of Agriculture).
- (3) To keep an accurate and complete record of all Board meetings and hearings, and to have legal custody of all books, papers, documents and other records of the Board.
- (4) To assign and reassign the administrative and enforcement duties and functions assigned to him in this Article to one or more of the divisions and other units within the Department of Agriculture.
- (5) To direct the work of the personnel employed by the Board and of the personnel of the Department of Agriculture who have responsibilities concerning the programs set forth in this Article.
- (6) To delegate to any division head or other officer or employee of the Department of Agriculture any of the powers and duties given to the Department by statute or by the rules, regulations and procedures established pursuant to this Article.
- (7) To perform such other duties as the Board may from time to time direct. (1971, c. 832, s. 1.)

**§143-439. Pesticide Advisory Committee; creation and functions.**—(a) There is hereby authorized the establishment of the Pesticide Advisory Committee, which shall assist the Board and the Commissioner in an advisory capacity on matters which may be submitted to it by the Board or the Commissioner, including technical questions and the development of rules and regulations.

(b) The Pesticide Advisory Committee shall consist of 17 members to be appointed by the Board, as follows: three practicing farmers; one conservationist (at large); one ecologist (at large); one representative of the pesticide industry; one representative of agribusiness (at large); one local health director; three members of the North Carolina State University School of Agriculture and Life Sciences, at least one of which shall be from the area of wildlife and/or biology; one member each representing the North Carolina Department of Agriculture, the North Carolina Department of Human Resources and a State conservation agency; one representative of a public utility or railroad company which uses pesticides, or of the Board of Transportation; one member of the North Carolina Agricultural Aviation Association; and one member of the general public (at large).

(c) Members of the Pesticide Advisory Committee shall serve at the pleasure of the Board. The members who are not officers or employees of the State shall receive regular State subsistence and travel expenses. (1971, c. 832, s. 1; 1973, c. 476, s. 128; c. 507, s. 5; 1975, c. 824.)



101

(1) The person  
 (2) The person  
 (3) The person  
 (4) The person  
 (5) The person  
 (6) The person  
 (7) The person  
 (8) The person  
 (9) The person  
 (10) The person  
 (11) The person  
 (12) The person  
 (13) The person  
 (14) The person  
 (15) The person  
 (16) The person  
 (17) The person  
 (18) The person  
 (19) The person  
 (20) The person  
 (21) The person  
 (22) The person  
 (23) The person  
 (24) The person  
 (25) The person  
 (26) The person  
 (27) The person  
 (28) The person  
 (29) The person  
 (30) The person  
 (31) The person  
 (32) The person  
 (33) The person  
 (34) The person  
 (35) The person  
 (36) The person  
 (37) The person  
 (38) The person  
 (39) The person  
 (40) The person  
 (41) The person  
 (42) The person  
 (43) The person  
 (44) The person  
 (45) The person  
 (46) The person  
 (47) The person  
 (48) The person  
 (49) The person  
 (50) The person

102

## Part 2. Regulation of the Use of Pesticides.

**§143-440. Restricted-use pesticides regulated.**—(a) The Board may, by regulation after a public hearing, adopt and from time to time revise a list of restricted-use pesticides for the State or for designated areas within the State. The Board may designate any pesticide or device as a "restricted-use pesticide" upon the grounds that, in the judgment of the Board (either because of its persistence, its toxicity, or otherwise) it is so hazardous or injurious to persons, pollinating insects, animals, crops, wildlife, lands, or the environment, other than the pests it is intended to prevent, destroy, control, or mitigate that additional restrictions on its sale, purpose, use or possession are required.

(b) The Board may include in any such restricted-use regulation the time and conditions of sale, distribution, or use of such restricted-use pesticides; may prohibit the use of any restricted-use pesticide for designated purposes or at designated places or times; may require the purchaser or user to certify that restricted-use pesticides will be used only as labeled or as further restricted by regulation may require the certification of private applicators; and may, if it deems it necessary to carry out the provisions of this Part, require that any or all restricted-use pesticides shall be purchased, possessed, or used only under permit of the Board and under its direct supervision in certain areas and/or under certain conditions or in certain quantities or concentrations except that any person licensed to sell such pesticides may purchase and possess such pesticides without a permit. The Board may require all persons issued such permits to maintain records as to the use of the restricted-use pesticides. The Board may authorize the use of restricted-use pesticides by persons licensed under the North Carolina Structural Pest Control Act without a permit. (1971, c. 832, s. 1; 1979, c. 448, s. 1.)

**§143-441. Handling, storage and disposal of pesticides.**—(a) The Board may adopt regulations:

- (1) Concerning the handling, transport, storage (which may include security precautions), display or distribution of pesticides, and concerning the disposal of pesticides and pesticide containers.
- (2) Restricting or prohibiting the use of certain types of containers or packages for specific pesticides. These restrictions may apply to type of construction, strength, and/or size to alleviate danger of spillage, breakage, or misuse.

(b) No person shall handle, transport, store, display, or distribute pesticides in such a manner as to endanger man and his environment or to endanger food, feed, or any other products that may be transported, stored, displayed, or distributed with pesticides, or in any manner contrary to the regulations of the Board.

(c) No person shall dispose of, discard, or store any pesticides or pesticide containers in such a manner as may cause injury to humans, vegetation, crops, livestock, wildlife, or to pollute any water supply or waterway, or in any manner contrary to the regulations of the Board. (1971, c. 832, s. 1.)

**§143-442. Registration.**—(a) Every pesticide prior to being distributed, sold, or offered for sale within this State or delivered for transportation or transported in intrastate commerce or between points within this State through any point outside this State shall be registered in the office of the Board, and such registration shall be renewed annually before January 1 for the ensuing calendar year. The applicant for registration shall file with the Board a statement including:

- (1) The name and address of the applicant and the name and address of the person whose name will appear on the label, if other than the applicant;
- (2) The name of the pesticide;
- (3) A complete copy of the labeling accompanying the pesticide and a statement of all claims to be made for it including directions for use; and
- (4) If requested by the Board a full description of the tests made and the results thereof upon which the claims are based. In the case of renewal of registration, a statement shall be required with respect to information which is different from that furnished when the pesticide was registered or last reregistered.

(b) The applicant shall pay an annual registration fee of twenty-five dollars (\$25.00) for each brand or grade of pesticide registered. An additional twenty-five dollars (\$25.00) delinquent registration penalty shall be assessed against the registrant for each brand or grade of pesticide which is marketed in North Carolina prior to registration as required by this Article.

(c) The Board, when it deems necessary in the administration of this Article, may require the submission of the complete formula of any pesticide.

(d) If it appears to the Board that the composition of an article is such as to warrant the proposed claims for it and if the article and its labeling and other material required to be submitted comply with the requirements of G.S. 143-443 the Board shall register the article. If it does not appear to the Board that the article is such as to warrant the proposed claims for it or if the article and its labeling and other material required to be submitted do not comply with the provisions of this Part, it shall not register the article and in turn shall notify the applicant of the manner in which the article, labeling, or other material required to be submitted fail to comply. The Board, in accordance with the procedures specified herein, may suspend or cancel the registration of a pesticide whenever it does not appear that the article or its labeling complies with the provisions of this Part. Whenever an application for registration is refused or the Board proposes to suspend or cancel a registration, notice of such action shall be given to the applicant or registrant who shall have the right within ten days of receipt of such notice to request a hearing on the action or proposed action of the Board, as provided in G.S. 143-464.

(e) The Board is authorized and empowered to refuse to register, or to cancel the registration of any or all brands and grades of pesticides as herein provided, if the registrant fails or refuses to comply with the provisions of this Part, or any rules and regulations promulgated thereunder, or, upon satisfactory proof that the registrant or applicant has been guilty of fraudulent and deceptive practices in the evasions or attempted evasions of the provisions of this Part, or any rules and regulations promulgated thereunder: Provided, that no registration shall be revoked or refused until the registrant or applicant shall have been given the opportunity for a hearing by the Board, as provided in G.S. 143-464.

(f) Notwithstanding any other provisions of this Part, registration is not required in the case of a pesticide shipped from one plant within this State to another plant within this State operated by the same person.

(g) Any pesticide declared to be discontinued by the registrant must be registered by the registrant for one full year after distribution is discontinued. Any pesticide in channels of distribution after the aforesaid registration period may be



confiscated and disposed of by the Board, unless the pesticide is acceptable for registration and is continued to be registered by the manufacturer of the person offering the pesticide for wholesale or retail sale. Provided, however, this subsection shall not apply to any brand or grade of pesticide which the Board determines does not remain in channels of distribution due to method of sale by registrant directly to users thereof.

(h) A pesticide may be registered by the Board for experimental use, including use to control wild animal or bird populations, even though the Wildlife Resources Commission may not have concurred in the declaration of the animal or bird population as pests under the terms of Article 22A of Chapter 113 of the General Statutes.

(i) The Board shall be empowered to set forth criteria for determining when a given product constitutes a different or separate brand or grade of pesticide. (1971, c. 832, s. 1; 1973, c. 389, ss. 1, 7; 1975, c. 425, ss. 1, 2; 1979, c. 448, ss. 2, 3, c. 830, s. 10, effective July 1, 1980.)

**§143-443. Miscellaneous prohibited acts.**—(a) It shall be unlawful for any person to distribute, sell, or offer for sale within this State or deliver for transportation or transport in intrastate commerce or between points within this State through any point outside this State any of the following:

- (1) Any pesticide which has not been registered pursuant to the provisions of G.S. 143-442, or any pesticide if any of the claims made for it or any of the directions for its use differ in substance from the representations made in connection with the registration, or if the composition of a pesticide differs from its composition as represented in connection with its registration: Except that, in the discretion of the Board, a change in the labeling or formula of a pesticide may be made within a registration period without requiring reregistration of the product.
- (2) Any pesticide unless it is in the registrant's or the manufacturer's unbroken immediate container, and there is affixed to such container, and to the outside container or wrapper of the retail package, if there be one through which the required information on the immediate container cannot be clearly read, a label bearing:
  - a. The name and address of the manufacturer, registrant, or person for whom manufactured;
  - b. The name, brand, or trademark under which said article is sold; and
  - c. The net weight or measure of the content subject, however, to such reasonable variations as the Board may permit.
- (3) Any pesticide which contains any substance or substances in quantities highly toxic to man, determined as provided in G.S. 143-444, unless the label shall bear, in addition to any other matter required by this Part:
  - a. The skull and crossbones;
  - b. The word "poison" prominently, in red, on a background of distinctly contrasting color; and
  - c. A statement of an antidote for the pesticide.
- (4) The pesticides commonly known as standard lead arsenate, basic lead arsenate, calcium arsenate, magnesium arsenate, zinc arsenate, zinc arsenite, sodium fluoride, sodium fluosilicate, and barium fluosilicate unless they

have been distinctly colored or discolored as provided by regulations issued in accordance with this Part, or any other white or lightly colored pesticide which the Board, after investigation of and after public hearing on the necessity for such action for the protection of the public health and the feasibility of such coloration or discoloration, shall, by regulation, require to be distinctly colored or discolored; unless it has been so colored or discolored, provided, that the Board may exempt any pesticide to the extent that it is intended for a particular use or uses from the coloring or discoloring required or authorized by this section if the Board determines that such coloring or discoloring for such use or uses is not necessary for the protection of the public health.

- (5) Any pesticide which is adulterated or misbranded, (or any device which is misbranded).
  - (6) Any pesticide in containers violating regulations adopted pursuant to G.S. 143-441. Pesticides found in containers which are unsafe due to damage or defective construction may be seized and impounded.
- (b) It shall be unlawful:
- (1) For any person to detach, alter, deface, or destroy, in whole or in part, any label or labeling provided for in this Part or regulations promulgated hereunder, or to add any substance to, or take any substance from a pesticide in a manner that may defeat the purpose of this Part;
  - (2) For any person to use for his own advantage or to reveal, other than to the Board or proper officials or employees of the State or federal government or to the courts of this State in response to a subpoena, or to physicians, or in emergencies to pharmacists and other qualified persons, for use in the preparation of antidotes, any information relative to formulas of products acquired by authority of G.S. 143-442.
  - (2a) For any person to use any pesticide in a manner inconsistent with its labeling, including, by way of illustration but not limitation, the use of a pesticide on a crop, animal, or site not permitted by the labeling. (1971, c. 832, s. 1; 1975, c. 425, s. 3; 1979, c. 448, ss. 4, 5.)

**§143-444. Determinations.**—The Board is authorized:

- (1) To declare as a pest any form of plant or animal life or virus which is injurious to plants, man, domestic animals, articles, or substances;
- (2) To determine whether pesticides are highly toxic to man; and
- (3) To determine standards of coloring or discoloring for pesticides, and to subject pesticides to the requirements of G.S. 143-443(a) (4). (1971, c. 832, s. 1.)

**§143-445. Exemptions.**—(a) The penalties provided for violations of G.S. 143-443(a) shall not apply to:

- (1) Any carrier while lawfully engaged in transporting pesticides within this State, if such carrier shall, upon request, permit the Board or its designated agent to copy all records showing the transactions in and movement of the articles;
- (2) Public officials of this State or local subdivisions thereof and the federal government engaged in the performance of their official duties;



(3) The manufacturer or shipper of a pesticide for experimental use only,

- a. By or under the supervision of an agency of this State or of the federal government authorized by law to conduct research in the field of pesticides, or
- b. By others if the pesticide is not sold and if the container thereof is plainly and conspicuously marked "For experimental use only—Not to be sold," together with the manufacturer's name and address; (except that if a written permit has been obtained from the Board, pesticides may be sold for experimental purposes subject to such restrictions and conditions as may be set forth in the permit).

(b) No article shall be deemed in violation of this Part when intended solely for export to a foreign country, and when prepared or packed according to the specifications or directions of the purchaser. If not so exported, all the provisions of this Part shall apply. (1971, c. 832, s. 1.)

**§143-446. Samples; submissions.**—(a) The Board, or its agent, is authorized and directed to sample, test, inspect and make analyses of pesticides sold or offered for sale or distributed within this State, at time and place and to such an extent as it may deem necessary to determine whether such pesticides are in compliance with the provisions of this Article. The Board is authorized to adopt regulations concerning the collection and examination of samples (or devices), and to adopt regulations establishing tolerances providing for reasonable deviations from the guaranteed analysis.

(b) The official analysis shall be made from the official sample. A sealed and identified sample, herein called "official check sample" shall be kept until the analysis is completed on the official sample, except that the registrant may obtain upon request a portion of said official sample. If the official analysis conforms with the provisions of this Part, the official check sample may be destroyed. If the official analysis does not conform with the provisions of this Part, then the official check sample shall be retained for a period of 90 days from the date of the certificate of analysis of the official sample.

(c) The Board, of its own motion or upon complaint, may cause an examination to be made for the purpose of determining whether any pesticide complies with the requirements of this Part. If it shall appear from such examination that a pesticide fails to comply with the provisions of this Part, the Board may cause notice to be given to the offending person in the manner provided in G.S. 143-464, and the proceedings thereupon shall be as provided in such section; provided that pesticides may be seized and confiscated as provided in G.S. 143-447.

(d) The Board shall, by publication in such manner as it may prescribe, give notice of all judgments entered in actions instituted under the authority of this Article. (1971, c. 832, s. 1.)

**§143-447. Emergency suspensions; seizures.**—(a) Notwithstanding any other provision of this Article, the Board may, when it finds that such action is necessary to prevent an imminent hazard to the public, or any other nontarget organism or segment of the environment, by order, suspend the registration of a pesticide immediately. In such case, it shall give the registrant prompt notice of such action and afford the registrant the opportunity for an expedited hearing. Final orders of the Board under this Part shall be subject to review as provided for in G.S. 143-464. Such review shall be instituted within 30 days after receipt by the applicant for reg-

istration or registrant of the Board's order. In no event shall registration of a pesticide be construed as a defense to any charge of an offense prohibited under this Article.

(b) It shall be the duty of the Board to issue and enforce a written or printed "stop sale, stop use, or removal" order to the owner or custodian of any lot of pesticide and for the owner or custodian to hold said lot at a designated place when the Board finds said pesticide is being offered or exposed for sale in violation of any of the provisions of this Article until the law has been complied with and said pesticide is released in writing by the Board or said violation has been otherwise legally disposed of by written authority. The Board shall release the pesticide so withdrawn when the requirements of the provisions of this Article have been complied with and upon payment of all costs and expenses incurred in connection with the withdrawal. The registrant of a pesticide found deficient in active ingredients shall be subject to a penalty for the deficiency. The deficiency penalty shall be three times the percentage deficiency times the retail value of any product sold subsequent to sampling and prior to repossession, but not less than twenty-five dollars (\$25.00).

(c) Any pesticide (or device) that is distributed, sold, or offered for sale within this State or delivered for transportation or transported in intrastate commerce between points within this State through any point outside this State shall be liable to be proceeded against in superior court in any county of the State where it may be found and seized for confiscation by process or libel for condemnation:

(1) In the case of a pesticide,

- a. If it is adulterated or misbranded,
- b. If it has not been registered under the provisions of G.S. 143-442,
- c. If it fails to bear on its label the information required by this Part,
- d. If it is a white or lightly colored pesticide and is not colored as required under this Part.

(2) In the case of a device, if it is misbranded.

(d) If the article is condemned, it shall, after entry of decree, be disposed of by destruction or sale as the court may direct and the proceeds, if such article is sold, less legal costs, shall be paid to the State Treasurer; provided that the article shall not be sold contrary to the provisions of this Part; and provided further that upon payment of costs and execution and delivery of a good and sufficient bond conditioned that the article shall not be disposed of unlawfully, the court may direct that said article be delivered to the owner thereof for relabeling or reprocessing or disposal, as the case may be.

(e) When a decree of condemnation is entered against the article, court costs and fees and storage and other proper expenses shall be awarded against the person, if any, intervening as claimant of the article. (1971, c. 832, s. 1; 1979, c. 448, s. 6.)

### Part 3. Pesticide Dealers and Manufacturers.

**§143-448. Licensing of pesticide dealers; fees.**—(a) No person shall act in the capacity of a pesticide dealer, or shall engage or offer to engage in the business of, advertise as, or assume to act as a pesticide dealer unless he is licensed annually as provided in this Part. A separate license and fee shall be obtained for each location

of the  
of the  
of the  
of the

application  
of license  
because is

and on in  
renewal  
in before  
from the  
for sale

cases

of this  
in the  
cases is

an appli-  
ing his

aying on  
out dem-  
by the  
in coun-  
the govern-

the  
the year the  
in the face  
of the

of the  
of the

of the  
of the  
of the

of the  
of the  
of the

or outlet from which restricted-use pesticides are distributed, sold, held for sale, or offered for sale.

(b) Applications for a pesticide dealer license shall be in the form and shall contain the information prescribed by the Board. Each application shall be accompanied by a fee of twenty-five dollars (\$25.00). All licenses issued under this Part shall expire on December 31 of the year for which they are issued.

(c) The license for a pesticide dealer may be renewed annually upon application to the Board, accompanied by a fee of twenty-five dollars (\$25.00) for each license, on or before the first day of January of the calendar year for which the license is issued.

(d) If an application for renewal of a pesticide dealer's license is not filed on or before January 1 of any year, a penalty of twenty-five percent (25%) of the renewal fee shall be assessed and added to the fee, and shall be paid by the applicant before the renewal license is issued, but such penalty shall not apply if the applicant furnishes an affidavit that he has not distributed, sold, held for sale or offered for sale any restricted-use pesticide subsequent to the expiration of his prior license.

(e) Every licensed pesticide dealer who changes his address or place of business shall immediately notify the Board.

(f) The Board shall issue to each applicant that satisfies the requirements of this Part a license which entitles the applicant to conduct the business described in the application for the calendar year for which the license is issued, unless the license is sooner revoked or suspended. (1971, c. 832, s. 1.)

**§143-449. Qualifications for pesticide dealer license; examinations.**—(a) An applicant for a license must present evidence satisfactory to the Board concerning his qualifications for such license.

(b) Each applicant shall satisfy the Board as to his responsibility in carrying on the business of a pesticide dealer. Each applicant for an original license must demonstrate upon written, or written and oral, examination to be prescribed by the Board his knowledge of pesticides, their usefulness and their hazards; his competence as a pesticide dealer; and his knowledge of the laws and regulations governing the use and sale of pesticides.

(c) The Board shall by regulation:

(1) Designate what persons or class of persons shall be required to pass the examination in the case of a pesticide dealer operating more than one location, and in the case of an applicant that is a corporation, governmental unit or agency, or other organized group;

(2) Provide for renewal license examinations at intervals not more frequent than four years. (1971, c. 832, s. 1; 1975, c. 425, s. 4.)

**§143-450. Employees of pesticide dealers; dealer's responsibility.**—(a) Every licensed pesticide dealer shall submit to the Board, at such times as the Board or the Commissioner may prescribe, the names of all persons employed by him who sell or recommend "restricted-use pesticides."

(b) Each pesticide dealer shall be responsible for the actions of every person who acts as his employee or agent in the solicitation or sale of pesticides, and in all claims and recommendations for use or application of pesticides. (1971, c. 832, s. 1; 1979, c. 448, s. 7.)

**§143-451. Denial, suspension, and revocation of license.**—(a) The Board may suspend for not longer than thirty days, pending inquiry, and, after opportunity for a hearing, the Board may deny, suspend, revoke, or modify the provision of any license issued under this Part, if it finds that the applicant or licensee or his employee has committed any of the following acts, each of which is declared to be a violation of this Part:

- (1) Made false or fraudulent claims through any media, misrepresenting the effect of materials or methods to be utilized or sold;
- (2) Made a pesticide recommendation not in accordance with the label registered pursuant to this Article;
- (3) Violated any provision of this Article or of any rule or regulation adopted by the Board or of any lawful order of the Board;
- (4) Failed to pay the original or renewal license fee when due, and continued to sell restricted-use pesticides without paying the license fee, or sold restricted-use pesticides without a license;
- (5) Was guilty of gross negligence, incompetency or misconduct in acting as a pesticide dealer;
- (6) Refused or neglected to keep and maintain the records required by this Article, or to make reports when and as required, or refusing to make these records available for audit or inspection;
- (7) Made false or fraudulent records, invoices, or reports;
- (8) Used fraud or misrepresentation, or presented false information, in making an application for a license or renewal of a license, or in selling or offering to sell restricted-use pesticides;
- (9) Refused or neglected to comply with any limitations or restrictions on or in a duly issued license or permit;
- (10) Aided or abetted a licensed or an unlicensed person to evade the provisions of this Article, combined or conspired with such a licensed or unlicensed person to evade the provisions of this Article, or allowed one's license to be used by an unlicensed person;
- (11) Impersonated any state, county, or city inspector or official;
- (12) Stored or disposed of containers or pesticides by means other than those prescribed on the label or adopted regulations.

(b) Any licensee whose license is revoked under the provisions of this Article shall not be eligible to apply for a new license hereunder until such time has elapsed from the date of the order revoking said license as established by the Board (not to exceed two years), or if an appeal is taken from said order or revocation, not to exceed two years from the date of the order or final judgment sustaining said revocation. (1971, c. 832, s. 1; 1975, c. 425, ss. 6, 7.)

#### Part 4. Pesticide Applicators and Consultants

**§143-452. Licensing of pesticide applicators; fees.**—(a) No person shall engage in the business of pesticide applicator within this State at any time unless he is licensed annually as a pesticide applicator by the Board.



de it po an  
ecc pare  
le a  
you  
at se  
ip  
be  
the

(b) Applications for a pesticide applicator license shall be in the form and shall contain the information prescribed by the Board. Each application shall be accompanied by a fee of twenty-five dollars (\$25.00) for each pesticide applicator's license. In addition, an annual inspection fee of ten dollars (\$10.00) shall be submitted for each aircraft to be licensed. Should any aircraft fail to pass inspection, making it necessary for a second inspection to be made, the Board shall require an additional ten dollars (\$10.00) inspection fee. In addition to the required inspection, unannounced inspections may be made without charge to determine if equipment is properly calibrated and maintained in conformance with the laws and regulations. All aircraft licensed to apply pesticides shall be identified by a license plate or decal furnished by the Board at no cost to the licensee, which plate or decal shall be affixed on the aircraft in a location and manner prescribed by the Board. No applicator inspection or license fee, original or renewal, shall be charged to State agencies or local governments or their employees. Inspections of ground pesticide application equipment may be made. Any such equipment determined to be faulty or unsafe shall not be used for the purpose of applying a pesticide(s) until such time as proper repairs and/or alterations are made.

(c) If the application for renewal of any license provided for in this Part is not filed prior to January 1 in any year, a penalty fee of twenty-five percent (25%) shall be assessed and added to the original fee and shall be paid by the applicant before the renewal license shall be issued.

(d) The Board shall classify licenses to be issued under this Part. Separate classifications or subclassifications shall be specified for (i) ground and aerial methods of application, and (ii) State and local government units engaged in the control of rodents and insects of public health significance. The Board may include such further classifications and subclassifications as the Board considers appropriate, including provisions for licensing of apprentice pesticide applicators. For aerial applicators, a license shall be required for both the contractor and the pilot. Each classification and subclassification may be subject to separate testing procedures and requirements.

(e) Every licensed pesticide applicator who changes his address shall immediately notify the Board.

(f) If the Board finds the applicant qualified to apply pesticides in the classifications he has applied for and, if the applicant files the bond or insurance required under G.S. 143-467, and if the applicant applying for a license to engage in aerial application of pesticides has met all of the requirements of the Federal Aviation Agency to operate the equipment described in the application, the Board shall issue a pesticide applicator's license limited to the classifications for which he is qualified. Every such license shall expire at the end of the calendar year of issue unless it has been revoked or suspended prior thereto by the Board for cause, or unless such financial security required under G.S. 143-467 is dated to expire at an earlier date, in which case said license shall be dated to expire upon expiration date of said financial security. The license may restrict the applicant to the use of a certain type or types of equipment or pesticides or to certain areas if the Board finds that the applicant is qualified to use only such type or types. If a license is not issued as applied for, the Board shall inform the applicant in writing of the reasons therefor.

(g) A pesticide applicator's license shall not be transferable. When there is a transfer of ownership, management, or operation of a business of a licensee hereunder, the new owner, manager, or operator (as the case may be) whether it be an

individual, firm, partnership, corporation, or other entity, must have available a licensed pesticide applicator to supervise the pesticide application business prior to continuance of such business.

(h) Any licensee whose license is lost or destroyed may secure a duplicate license for a fee of two dollars (\$2.00). (1971, c. 832, s. 1; 1973, c. 389, ss. 2, 5; 1977, c. 100.)

**§143-453. Qualifications for pesticide applicator's license; examinations.**—(a) An applicant for a license must present satisfactory evidence to the Board concerning his qualifications for a pesticide applicator license. The contractor and each pilot involved in aerial application of pesticides shall be licensed. Those qualifications, in the case of a pilot, shall include at least 100 hours flying experience as a pilot in the field of aerial pesticide application. A pilot lacking 100 hours experience as a pilot in the field of aerial pesticide application may be licensed as an apprentice aerial pesticide applicator pilot provided that all aerial applications of pesticide by such licensed aerial pesticide applicator apprentice is conducted under the direction and supervision of a licensed pesticide applicator pilot.

(b) Each applicant shall satisfy the Board as to his knowledge of the laws and regulations governing the use and application of pesticides in the classifications he has applied for (manually or with various equipment that he may have applied for a license to operate), and as to his responsibility in carrying on the business of a pesticide applicator. Each applicant for an original license must demonstrate upon written, or written and oral, examination to be prescribed by the Board his knowledge of pesticides, their usefulness and their hazards; his competence as a pesticide applicator; and his knowledge of the laws and regulations governing the use and application of pesticides in the classification for which he has applied.

(c) The Board shall by regulation:

- (1) Designate what persons or class of persons shall be required to pass the examination in the case of an applicant that is a corporation or governmental unit or agency;
- (2) Provide for license renewal examinations at intervals not more frequent than four years, or more frequently if found by the Board to be required to be necessary in order to qualify North Carolina's State pesticide control plan for federal approval. (1971, c. 832, s. 1; 1973, c. 389, s. 4; 1975, c. 425, ss. 5, 9; 1977, c. 1125.)

**§143-454. Solicitors, salesmen and operators; applicator's responsibility.**—(a) Every licensed pesticide applicator shall submit to the Board, at such times as the Board or the Commissioner may prescribe, the names of all solicitors, salesmen, and operators employed by him.

(b) Each licensed pesticide applicator shall be responsible for solicitors, salesmen, and operators in his employment to assure that pesticides are used in a manner consistent with the intent of this Article. (1971, c. 832, s. 1; 1979, c. 448, s. 8.)

**§143-455. Pest control consultant license.**—(a) No person shall perform services as a pest control consultant without first procuring from the Board a license. Applications for a consultant license shall be in the form and shall contain the information prescribed by the Board. The application for a license shall be accompanied by an annual fee of twenty-five dollars (\$25.00).

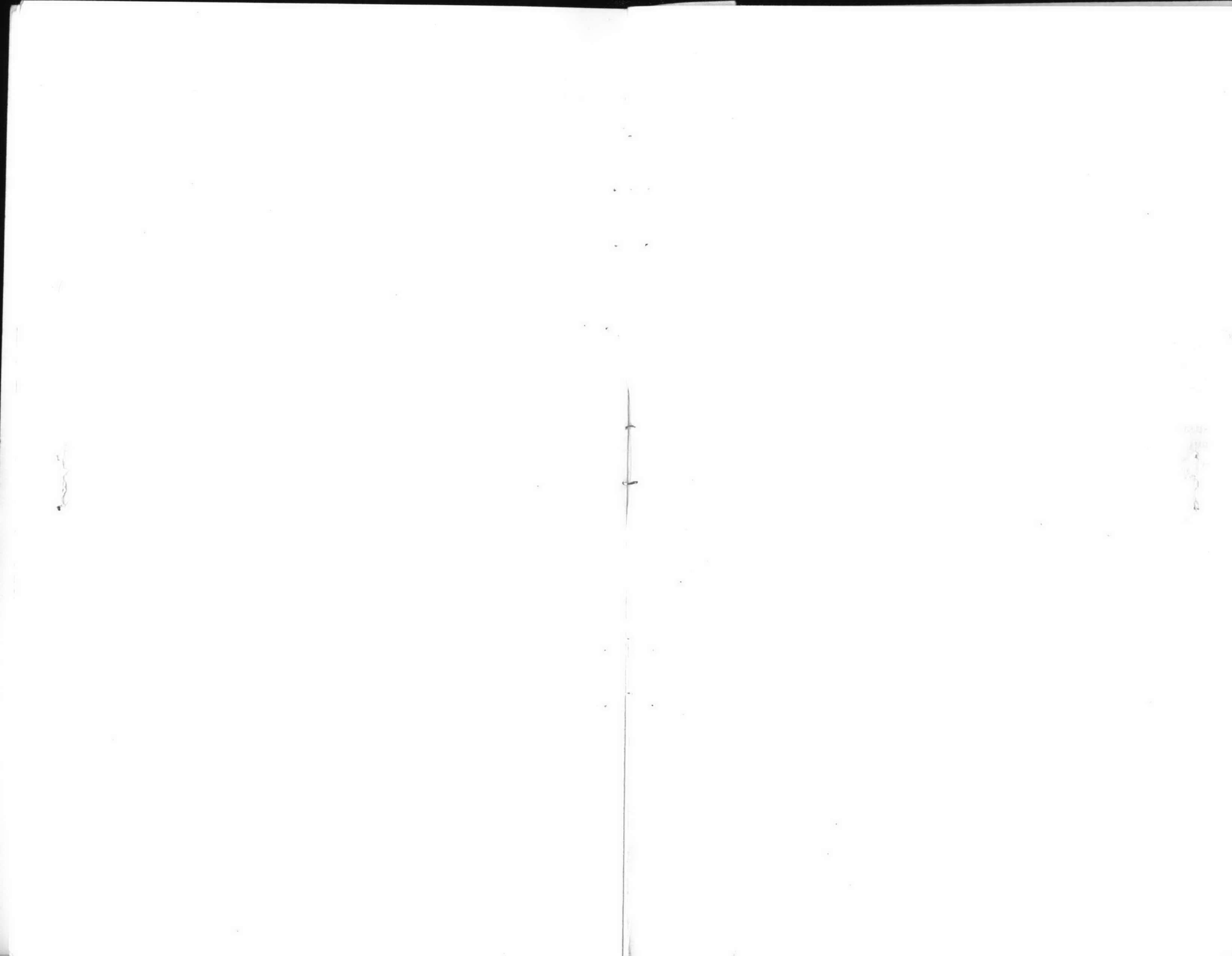

(b) An applicant for a consultant license must present satisfactory evidence to the Board concerning his qualifications for such license. The Board may classify consultant licenses into one or more classifications or subclassifications based upon types of consulting services performed or to be performed. Such classifications and subclassifications may reflect the crops involved in the consulting service, the discipline or training of consultant, the discretion or lack of discretion involved in the consulting service, and the site or location of the service. Each classification and subclassification may be subject to separate testing procedures and requirements, and may be subject to its own minimum standards of training in specialized subject matter from a recognized college or university, or equivalent specialized consulting experience or training. Qualifications for licensing may be less stringent if the licensee is restricted to making recommendations contained in publications recognized by the Board as appropriate for a specific consulting classification or subclassification.

(c) Each applicant shall satisfy the Board as to his responsibility in carrying on the business of a pesticide consultant. Each applicant for an original license must demonstrate upon written, or written and oral, examination to be prescribed by the Board his knowledge of pesticides, their usefulness and their hazards; his competence as a pesticide consultant; and his knowledge of the laws and regulations governing the use and sale of pesticides.

(d) Pest control consultants shall be subject to the same provisions as pesticide applicators concerning penalties for late applications for license, changes of address, transferability of licenses, periodic reexamination, and examinations for corporate applicants. (1971, c. 832, s. 1; 1975, c. 425, s. 10).

**§143-456. Denial, suspension, and revocation of license.**—(a) The Board may suspend for not longer than thirty days pending inquiry by the Commissioner, and, after opportunity for a hearing, the Board may deny, suspend, revoke, or modify the provisions of any license issued under this Part if it finds that the applicant or licensee or his registered employee has committed any of the following acts, each of which is declared to be a violation of this Part:

- (1) Made false or fraudulent claims through any media, misrepresenting the effect of materials or methods to be utilized;
- (2) Made a pesticide recommendation or application not in accordance with the label registered pursuant to this Article;
- (3) Operated faulty or unsafe equipment;
- (4) Operated in a faulty, careless, or negligent manner;
- (5) Violated any provision of this Article or of any rule or regulation adopted by the Board or any lawful order of the Board;
- (6) Refused or neglected to keep and maintain the records required by this Article, or to make reports when and as required;
- (7) Made false or fraudulent records, invoices, or reports;
- (8) Operated unlicensed equipment;
- (9) Used fraud or misrepresentation, or presented false information, in making an application for a license or renewal of a license;
- (10) Refused or neglected to comply with any limitations or restrictions on or in a duly issued license or permit;

- (11) Aided or abetted a licensed or an unlicensed person to evade the provisions of this Article, combined or conspired with such a licensed or unlicensed person to evade the provisions of this Article, or allowed one's license to be used by an unlicensed person;
- (12) Made false or misleading statements during or after an inspection concerning any infestation or infection of pests found on land;
- (13) Impersonated any state, county, or city inspector or official;
- (14) Stored or disposed of containers or pesticides by means other than those prescribed on the label or adopted regulations;
- (15) Failed to pay the original or renewal license fee when due and continued to operate as an applicator, or applied pesticides without a license.

(b) Any licensee whose license is revoked under the provisions of this Article shall not be eligible to apply for a new license hereunder until such time has elapsed from the date of the order revoking said license as established by the Board (not to exceed two years), or if an appeal is taken from said order or revocation, not to exceed two years from the date of the order or final judgment sustaining said revocation. (1971, c. 832, s. 1; 1975, c. 425, ss. 6, 8.)

**§143-457. Damaged person must file report of loss; contents; time for filing; effect of failure to file.**—(a) Any person claiming damages from pesticide application shall have filed with the Board a written statement claiming that he has been damaged, on a form prescribed by the Board within 21 days after the date that damages are apparent, or prior to the time that twenty-five percent (25%) of a crop damaged shall have been harvested. Such statement shall contain, but shall not be limited thereto, the name of the person responsible for the application of said pesticide, the name of the owner or lessee of the land on which the crop is grown and for which damages are claimed and the date on which it is alleged that the damage occurred. The Board shall prepare a form to be furnished to persons to be used in such cases and such form shall contain such other requirements as the Board may deem proper. The Board shall, upon receipt of such statement, notify the licensee and the owner or lessee of the land or other person who may be charged with the responsibility, for the damages claimed, and furnish copies of such statements as may be requested.

(b) The filing of such report or the failure to file such a report need not be alleged in any complaint which might be filed in a court of law, and the failure to file the report shall not be considered any bar to the maintenance of any criminal or civil action. The failure to file such a report shall not be a violation of this Article. However, if the person failing to file such a report is the only one injured from such use or application of a pesticide by others, the Board may, when in the public interest, refuse to hold a hearing for the denial, suspension, or revocation of a license or permit issued under this Article until such report is filed. Where damage is alleged to have been done, the claimant shall permit the licensee and his representatives, such as bondsman or insurer, to observe within reasonable hours the lands or nontarget organism alleged to have been damaged in order that such damage may be examined. Failure of the claimant to permit such observation and examination of the damaged lands shall automatically bar the claim against the licensee. (1971, c. 832, s. 1.)

**§143-458. Rules and regulations concerning methods of application.**—(a) The Board shall have authority to issue regulations after notice and hearing as provided by G.S. 143-463 to carry out the provisions and purpose of this Part and in such

12/20/2018

12/20/2018

12/20/2018

12/20/2018

12/20/2018

12/20/2018

12/20/2018

12/20/2018

12/20/2018

12/20/2018

12/20/2018

12/20/2018

12/20/2018

12/20/2018

12/20/2018

12/20/2018

12/20/2018

12/20/2018

12/20/2018

12/20/2018

12/20/2018

12/20/2018

12/20/2018

12/20/2018

12/20/2018

12/20/2018

12/20/2018

12/20/2018

12/20/2018

12/20/2018

12/20/2018

12/20/2018

12/20/2018

12/20/2018

12/20/2018

12/20/2018

12/20/2018

12/20/2018

12/20/2018

12/20/2018

12/20/2018

12/20/2018

12/20/2018

12/20/2018

12/20/2018

12/20/2018

12/20/2018

12/20/2018

regulations may prescribe methods to be used in the application of pesticides. Where the Board finds that such regulations are necessary to carry out the provisions of this Part, such regulations may relate to the time, place, manner, and method of application of the pesticides, may restrict or prohibit sale and use of pesticides in designated areas during specified periods of time and shall encompass all reasonable factors which the Board deems necessary to prevent damage or injury by drift or misapplication to:

- (1) Plants, including forage plants, on adjacent or nearby land;
- (2) Wildlife in the adjoining or nearby areas;
- (3) Fish and other aquatic life in waters in reasonable proximity to the area to be treated; or
- (4) Other animals, persons or beneficial insects.

In issuing such regulations, the Board shall give consideration to pertinent research findings and recommendations of other agencies of this State or of the federal government.

(b) The Board may by regulation require that notice of a proposed application of a pesticide be given to land owners adjoining the property to be treated or in the immediate vicinity thereof, if it finds that such notice is necessary to carry out the purpose of this Article. (1971, c. 832, s. 1.)

**§143-459. Reporting of shipments and volumes of pesticides.**—Every person selling pesticides directly to the consumer shall file with the Board, in such manner and with such frequency as the Board may prescribe, reports of purchases, sales and shipments of restricted-use pesticides and other pesticides designated by the Board. Failure to file any report when due shall be cause for suspension or revocation of any license or registration issued under this Article, or for denial of the issuance or renewal of any such license or registration, and shall be a misdemeanor, punishable as provided by G.S. 143-469. The time for reporting may be extended for an additional 15 days for cause, upon written request to the Board. All reports provided under this Part, are provided solely for the purposes of the Board. (1971, c. 832, s. 1.)

### Part 5. General Provisions.

**§143-460. Definitions.**—As used in this Article, unless the context otherwise requires:

- (1) The term "active ingredient" means
  - a. In the case of a pesticide other than a plant regulator, defoliant, or desiccant, an ingredient which will prevent, destroy, repel, or mitigate insects, nematodes, fungi, rodents, weeds, or other pests;
  - b. In the case of a plant regulator, an ingredient which, through physiological action, will accelerate or retard the rate of growth or rate of maturation or otherwise alter the behavior of ornamental or crop plants or the produce thereof;
  - c. In the case of a defoliant, an ingredient which will cause the leaves or foliage to drop from a plant;
  - d. In the case of a desiccant, an ingredient which will artificially accelerate the drying of a plant tissue.

- (2) The term "adulterated" shall apply to any pesticide if its strength or purity falls below the professed standard or quality as expressed on labeling or under which it is sold, or if any substance has been substituted wholly or in part for the article, or if any valuable constituent of the article has been wholly or in part abstracted.
- (3) Reserved.
- (4) "Board" means the North Carolina Pesticide Board.
- (5) "Commissioner" means the North Carolina Commissioner of Agriculture.
- (6) "Committee" means the Pesticide Advisory Committee.
- (7) The term "defoliant" means any substance or mixture of substances intended for causing the leaves or foliage to drop from a plant, with or without causing abscission.
- (8) The term "desiccant" means any substance or mixture of substances intended for artificially accelerating the drying of plant tissues.
- (9) The term "device" means any instrument or contrivance intended for trapping, destroying, repelling, or mitigating insects or rodents or destroying, repelling, or mitigating fungi, weeds, nematodes, or such other pests as may be designated by the Board, but not including equipment used for the application of pesticides when sold separately therefrom.
- (10) "Engage in business" means any application of pesticide by any person for use upon lands of another, or any sale of pesticide by any person.
- (11) "Equipment" means any type of ground, water or aerial equipment, device, or contrivance using motorized, mechanical or pressurized power and used to apply any pesticide on land and anything that may be growing, habitating or stored on or in such land, but shall not include any pressurized hand-sized household device used to apply any pesticide or any equipment, device or contrivance of which the person who is applying the pesticide is the source of power or energy in making such pesticide application.
- (12) The term "fungus" means any non-chlorophyll-bearing thallophyte (that is, any non-chlorophyll-bearing plant of a lower order than mosses and liverworts), as for example, rust, smut, mildew, mold, yeast, and bacteria, except those on or in living man or other animals and those on or in processed food, beverages, or pharmaceuticals.
- (13) The term "fungicide" means any substance or mixture of substances intended for preventing, destroying, repelling or mitigating any fungi.
- (14) The term "herbicide" means any substance or mixture of substances intended for preventing, destroying, repelling or mitigating any weed.
- (15) The term "inert ingredient" means an ingredient which is not an active ingredient.
- (16) The term "ingredient statement" means
  - a. A statement of the name and percentage of each active ingredient, together with the total percentage of the inert ingredients, in the pesticide; and
  - b. In case the pesticide contains arsenic in any form, a statement of the per-



centages of total and water-soluble arsenic, each calculated as elemental arsenic.

- (17) The term "insect" means any of the numerous small invertebrate animals generally having the body more or less obviously segmented, for the most part belonging to the class Insecta, comprising six-legged, usually winged forms, as, for example, beetles, bugs, wasps, flies, and to other allied classes of arthropods whose members are wingless and usually have more than six legs, as, for example, spiders, mites, ticks, centipedes, and woodlice.
- (18) The term "insecticide" means any substance or mixture of substances intended for preventing, destroying, repelling, or mitigating any insects which may be present in any environment whatsoever.
- (19) The term "label" means the written, printed, or graphic matter on, or attached to, the pesticide (or device) or the immediate container thereof, and the outside container or wrapper of the retail package, if any there be, of the pesticide (or device).
- (20) The term "labeling" means all labels and other written, printed, or graphic matter:
  - a. Upon the pesticide (or device) or any of its containers or wrapper;
  - b. Accompanying the pesticide (or device) at any time;
  - c. To which reference is made on the label or in literature accompanying the pesticide (or device) except when accurate, nonmisleading reference is made to current official publications of the United States Department of Agriculture or Interior, the United States Public Health Service, state experiment stations, state agricultural colleges, or other similar federal institutions or official agencies of this State or other states authorized by law to conduct research in the field of pesticides.
- (21) "Land" means all land and water areas, including airspace, and all plants, animals, structures, buildings, devices and contrivances, appurtenant thereto or situated thereon, fixed or mobile, including any used for transportation.
- (22) "Manufacturer" includes any person engaged in the business of importing, producing, preparing, formulating, mixing, or processing pesticides.
- (23) The term "misbranded" shall apply:
  - a. To any pesticide or device if its labeling bears any statement, design, or graphic representation relative thereto or to its ingredients which is false or misleading in any particular;
  - b. To any pesticide:
    1. If it is an imitation of or is offered for sale under the name of another pesticide;
    2. If its labeling bears any reference to registration under this Article;
    3. If the labeling accompanying it does not contain instructions for use which are necessary and, if complied with, adequate for the protection of the public;
    4. If the label does not contain a warning or caution statement which may be necessary and, if complied with, adequate to prevent injury to living man and other vertebrate animals;
    5. If the label does not bear an ingredient statement on that part of the

immediate container and on the outside container or wrapper, if there be one, through which the ingredient statement on the immediate container cannot be clearly read, of the retail package which is presented or displayed under customary conditions of purchase except that the Board may permit the statement to appear prominently on some other part of the container, if the size or form of the container make it impractical to comply with the requirements of this subparagraph;

6. If any word, statement, or other information required by or under the authority of this Article to appear on the labeling is not prominently placed thereon with such conspicuousness (as compared with other words, statements, designs, or graphic matter in the labeling) and in such terms as to render it likely to be read and understood by the ordinary individual under customary conditions of purchase and use; or
  7. If in the case of an insecticide, nematocide, fungicide, or herbicide, when used as directed or in accordance with commonly recognized practice, it shall be injurious to living man or other vertebrate animals or vegetation, except weeds, to which it is applied, or to the person applying such pesticides or
  8. In the case of a plant regulator, defoliant, or desiccant when used as directed it shall be injurious to living man or other vertebrate animals, or vegetation to which it is applied, or to the person applying such pesticides, except that physical or physiological effects on plants or parts thereof shall not be deemed to be injury, when this is the purpose for which the plant regulator, defoliant, or desiccant was applied, in accordance with the label claims and recommendations.
- (24) The term "nematicide" means any substance or mixture of substances intended for preventing, destroying, repelling, or mitigating nematodes.
  - (25) The term "nematode" means invertebrate animals of the phylum nemathelminthes and class Nematoda, that is, unsegmented round worms with elongated, fusiform, or saclike bodies, covered with cuticle, and inhabiting soil, water, plants or plant parts; may also be called nemas or eelworms.
  - (26) A "person" is any person, including (but not limited to) an individual, firm, partnership, association, company, joint-stock association, public or private institution, municipality or county or local government unit (as defined in G.S. 143-215.40(b)), state or federal governmental agency, or private or public corporation organized under the laws of this State or the United States or any other state or country.
  - (27) "Pest control consultant" means any person; who, for a fee, offers or supplies technical advice, supervision, or aid, or recommends the use of specific pesticides for the purpose of controlling insects, plant diseases, weeds, and other pests, but does not include any person regulated by the North Carolina Structural Pest Control Act (G.S. Chapter 106, Article 4C).
  - (28) The term "pesticide" means
    - a. Any substance or mixture of substances intended for preventing, destroying, repelling, or mitigating any insects, rodents, nematodes, fungi, weeds, or other forms of plant or animal life or viruses, except viruses on or in living man or other animals, which the Board shall declare to be a pest, and



THE  
STATE OF  
NEW YORK  
IN SENATE  
JANUARY 18, 1907  
REPORT  
OF THE  
COMMISSIONERS OF THE  
LAND OFFICE  
IN RESPONSE TO  
RESOLUTION PASSED  
MAY 17, 1906

ALBANY:  
J. B. LIPPINCOTT & CO.,  
PRINTERS,  
1907.

- b. Any substance or mixture of substances intended for use as a plant regulator, defoliant, or desiccant.
- (29) "Pesticide applicator" includes any person who owns or manages a pesticide application business which is engaged in the business of applying pesticides upon the lands or properties of another; any public operator; any private golf course operator; any seed treater; any person engaged in demonstration or research pest control; and any other person who acts as a pesticide applicator and is not exempt from this definition. It does not include:
- Any person who uses or supervises the use of a pesticide (i) only for the purpose of producing an agricultural commodity on property owned or rented by him or his employer, or (ii) only (if applied without compensation other than trading of personal services between producers of agricultural commodities) on the property of another person, or (iii) only for the purposes set forth in (i) and (ii) above.
  - Any person regulated by the North Carolina Structural Pest Control Law (G.S. Chapter 106, Article 4C.)
- (30) The term "pesticide dealer" means any person who is engaged in the business of distributing, selling, offering for sale, or holding for sale restricted-use pesticides for distribution directly to users. The term "pesticide dealer" does not include:
- Persons whose sales of pesticides are limited to pesticides in consumer-sized packages (as defined by the Board) which are labeled and intended for home and garden use only and are not restricted-use pesticides, or
  - Practicing veterinarians and physicians who prescribe, dispense, or use pesticides in the performance of their professional services.
- (31) Repealed by Session Laws 1973, c. 389, s. 3.
- (32) The term "plant regulator" means any substance or mixture of substances, intended through physiological action, for accelerating or retarding the rate of growth or rate of maturation, or for otherwise altering the behavior of ornamental or crop plants or the produce thereof, but shall not include substances to the extent that they are intended as plant nutrients, trace elements, nutritional chemicals, plant inoculants, and soil amendments.
- (33) "Public operator" means any person in charge of any equipment used by public utilities (as defined by General Statutes Chapter 62), State agencies, municipal corporations, or other governmental agencies applying pesticides.
- (34) The term "registrant" means the person registering any pesticide pursuant to the provisions of this Article.
- (35) The term "restricted-use pesticide" means a pesticide which the Board has designated as such pursuant to G.S. 143-440.
- (36) The term "rodenticide" means any substance or mixture of substances intended for preventing, destroying, repelling, attracting, or mitigating rodents or any other vertebrate animal which the Board shall declare to be a pest.
- (37) The term "weed" means any plant or part thereof which grows where not wanted.

- (38) "Wildlife" means all living things that are neither human, domesticated, nor, as defined in this Article, pests; including but not limited to mammals, birds, and aquatic life. (1971, c. 832, s. 1; 1973, c. 389, s. 3; 1975, c. 425, s. 11; 1979, c. 448, ss. 9, 10.)

§143-461. **General powers of Board.**—In addition to the specific powers prescribed elsewhere in this Article, and for the purpose of carrying out its duties, the Board shall have the power, at any time and from time to time:

- To adopt from time to time and to modify and revoke official regulations interpreting and applying the provisions of this Article and rules of procedure establishing and amplifying the procedures to be followed in the administration of this Article: provided, that no such regulations and no rules of procedure shall be effective nor enforceable until published and filed as prescribed by G.S. 143-463. Unless the Board deems there are overriding policy considerations involved, any regulation of the Board, which will in the judgment of the Board result in severe curtailment of the usefulness or value of inventories or equipment in the hands of persons licensed under this Article, should be given a future effective date so as to minimize undue potential economic loss to licensees;
- To authorize the Commissioner by proclamation (i) to suspend or implement, in whole or in part, particular regulations of the Board which may be affected by variable conditions, or (ii) to suspend the application of any provision of this Part to any federal or State agency if it is determined by the Commissioner that emergency conditions require such action;
- To conduct such investigations as it may reasonably deem necessary to carry out its duties as prescribed by this Article;
- To conduct public hearings in accordance with the procedures prescribed by this Article;
- To delegate such of the powers of the Board as the Board deems necessary (other than its powers to adopt rules and regulations of any kind) to one or more of its members, to the Commissioner, or to any qualified employee of the Board or of the Commissioner; provided, that the provisions of any such delegation of power shall be set forth in the official regulations of the Board. Any person to whom a delegation of power is made to conduct a hearing shall report the hearing with its evidence and record to the Board for decision;
- To call upon the Attorney General for such legal advice and assistance as is necessary to the functioning of the Board;
- To institute such actions in the superior court in the county in which any defendant resides, or has his or its principal place of business, as the Board may deem necessary for the enforcement of any of the provisions of this Article or of any official actions of the Board, including proceedings to enforce subpoenas or for the punishment of contempt of the Board. Upon violation of any of the provisions of this Article, or of any regulation of the Board adopted under the authority of this Article the Board may, either before or after the institution of any other proceedings (civil or criminal), institute a civil action in the superior court in the name of the State for injunctive relief to restrain the violation and for such other or further relief in the premises as said court shall deem proper. Neither the institution of the

1870  
The following is a list of the  
names of the persons who  
were present at the meeting  
held on the 1st day of  
January 1870.

Mr. J. W. Smith  
Mr. J. B. Jones  
Mr. J. C. Brown  
Mr. J. D. White  
Mr. J. E. Green  
Mr. J. F. Black  
Mr. J. G. Grey  
Mr. J. H. Blue  
Mr. J. I. Red  
Mr. J. K. Yellow

action nor any of the proceedings thereon shall relieve any party to such proceedings from any other penalty or remedy prescribed by this Article for any violation of same;

- (8) To agree upon or enter into any settlements or compromises of any actions and to prosecute any appeals or other proceedings. (1971, c. 832, s. 1; 1973, c. 389, s. 6.)

**§143-462. Procedures for revocations and related actions affecting licenses.**—In all proceedings, the effect of which would be to revoke, suspend, deny, or withhold renewal of a license issued under Part 3 or Part 4 of this Article, or to deny permission to take an examination for such a license, the provisions of Chapter 150A of the General Statutes shall be applicable. (1971, c. 832, s. 1.)

**§143-463. Procedures for adoption of certain rules and regulations; publication of rules and regulations.**—(a) Prior to the adoption by the Board of rules or regulations authorized by G.S. 143-440, 143-441 or G.S. 143-458, the Board shall conduct one or more public hearings with respect to any such proposed action, in accordance with the procedures prescribed by subsection (b) of this section.

(b) The following provisions shall apply to the public hearings required by subsections (a) of this section:

(1) Notice of any such hearing shall be given not less than 20 days before the date of such hearing and shall state the date, time, and place of hearing, the subject of the hearing, and the action which the Board proposes to take. The notice shall either include details of such proposed action, or where such proposed action is too lengthy for publication, as hereinafter provided for, the notice shall specify that copies of such detailed proposed action can be obtained on request from the office of the Board in sufficient quantity to satisfy the requests of all interested persons.

(2) Any such notice shall be published at least once in one newspaper of general circulation in the State, and a copy of such notice shall be mailed to each person on the mailing list required to be kept by the Board pursuant to the provisions of G.S. 143-464.

(3) Any person who desires to be heard at any such public hearing shall give notice thereof in writing to the Board on or before the first date set for the hearing. The Board is authorized to set reasonable time limits for the oral presentation of views by any one person at any such public hearing. The Board shall permit anyone who so desires to file a written argument or other statement with the Board in relation to any proposed action of the Board any time within 10 days following the conclusion of any public hearing or within any such additional time as the Board may allow by notice given as prescribed in this section.

(c) Upon completion of hearings and consideration of submitted evidence and arguments with respect to any proposed action of the Board pursuant to this section, the Board shall adopt its final action with respect thereto and shall publish such final action as part of its official regulations.

(d) The Board is empowered to modify or revoke from time to time any final action previously taken by it pursuant to the subjects referred to in subsection (a); any such modification or revocation, however, to be subject to the procedural requirements of this section.

(e) All official acts of the Board which have or are intended to have general application effect shall be incorporated either in the Board's official regulations (applying and interpreting this Article), or in its rules of procedure. All such regulations and rules shall upon adoption thereof by the Board be printed (or otherwise duplicated), and a duly certified copy thereof shall immediately be filed with the Attorney General. One copy of each such action shall at the same time be mailed to all persons then on the mailing list, and additional copies shall at all times be kept at the office of the Board in sufficient numbers to satisfy all reasonable requests therefor. (1971, c. 832, s. 1; 1975, 2nd Sess., c. 983, s. 84; 1979, c. 448, s. 11.)

**§143-464. Procedures with respect to registration of pesticides and certain other matters; mailing list; seal; judicial review.**—(a) In any proceeding wherein an application for registration of a pesticide is refused or the Board proposes to suspend or cancel a registration, the Board shall give notice with respect to all steps of the proceeding only to each person directly affected by such proceedings who shall be made a party thereto. The Board shall also apprise all persons on its mailing list on the date when the action is taken of all of its official acts (such as the adoption of regulations or rules of procedure) which have, or are intended to have general application and effect. It shall be the duty of the Board to keep such a mailing list on which it shall record the name and address of each person who requests listing thereon, together with the date of receipt of such request. Any person may, by written request to the Board, ask to be permanently recorded on such mailing list.

(b) All notices which are required to be given by the Board or by any party to a proceeding shall be given by regular mail to all persons entitled thereto, including the Board. The certificate of the person designated by the Board to mail such notices that the notices were mailed, giving the mailing date, shall be conclusive in the absence of fraud. Notice by the Board may be given to any person upon whom a summons may be served in accordance with the provisions of law covering civil actions in the superior courts of this State. Any notice shall be sufficient if it reasonably sets forth the action requested or demanded or gives information as to action taken. The Board by its rules of procedure may prescribe other necessary practices and procedures with regard to the form, content, and procedure as to any particular notices.

(c) The following provisions, together with any additional provisions not inconsistent herewith which the Board may prescribe, shall be applicable in connection with hearings pursuant to this Article, except where other provisions are applicable in connection with specific types of hearings:

(1) Any hearing held pursuant to G.S. 143-442 whether called at the instance of the Board or of any person, shall be held upon not less than 20 days' written notice given by the Board to any person who is, or is entitled to be, a party to the proceedings with respect to which such hearings is to be held, unless a shorter notice is agreed upon by all such parties.

(2) All hearings shall be before the Board or its authorized agent or agents, and the hearing shall be open to the public. The Board, or its authorized agents, shall have the authority to administer oaths.

(3) A full and complete record of all proceedings at any hearing shall be taken by a reporter appointed by the Board or by some other method approved by the Attorney General. Any party to a proceeding shall be entitled to a copy of such record upon the payment of the reasonable cost thereof as determined by the Board.

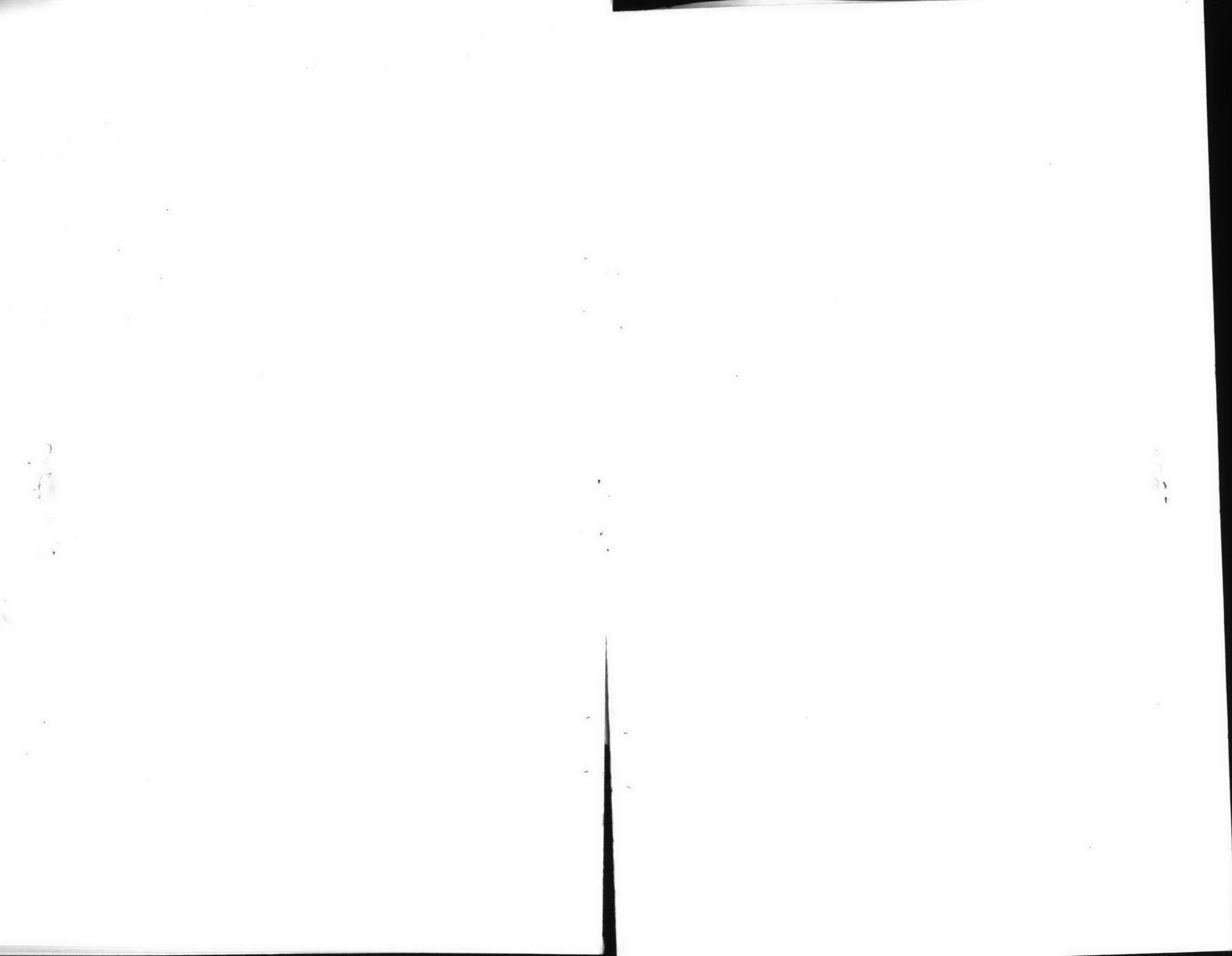

- (4) The Board shall follow generally the procedures applicable in civil actions in the superior court insofar as practicable, including rules and procedures with regard to the taking and use of depositions, the making and use of stipulations, and the entering into of agreed settlements and consent orders.
  - (5) Subpoenas or subpoenas duces tecum issued by the Board on its own behalf or on behalf of a party to the proceeding in connection with any hearing, shall be directed to any officer authorized by law to serve process, and the further procedures and rules of law applicable with respect thereto shall be prescribed in connection with subpoenas to the same extent as if issued by a court of record. In case of a refusal to obey a notice of hearing or subpoena issued by the Board, application may be made to the superior court of the appropriate county for enforcement thereof.
  - (6) The burden of proof at any hearing shall be upon the person or the Board, as the case may be, at whose instance the hearing is being held.
  - (7) Without regard to subdivision (6) of this subsection, the burden of proof to justify the safety of any pesticide shall be upon the applicant for registration or for licenses or permits to use, apply or sell pesticides.
  - (8) No decision or order of the Board shall be made in any proceeding unless the same is supported by competent, material and substantial evidence upon consideration of the whole record.
  - (9) Following any hearing, the Board shall afford the parties thereto a reasonable opportunity to submit within such time as prescribed by the Board proposed findings of fact and conclusions of law and any brief in connection therewith. The record in the proceeding shall show the Board's ruling with respect to each such requested finding of fact and conclusion of law.
  - (10) All orders and decisions of the Board shall set forth separately the Board's findings of fact and conclusions of law and shall, wherever necessary, cite the appropriate provision of law or other source of authority on which any action or decision of the Board is based.
  - (11) The Board shall have the authority to adopt a seal which shall be the seal of said Board and which shall be judicially noticed by the courts of the State. Any document, proceeding, order, decree, special order, rule, regulation, rule of procedure or any other official act or records of the Board or its minutes may be certified by the Chairman or Secretary of the Board under his hand and the seal of the Board, and when so certified shall be received in evidence in all actions or proceedings in the courts of the State without further proof of the identity of the same if such records are competent, relevant and material in any such action or proceeding. The Board shall have the right to take judicial notice of all studies, reports, statistical data or any other official reports or records of the federal government or of any sister state and all such records, reports and data may be placed in evidence by the Board or by any other person or interested party where material, relevant and competent.
- (d) Any person who is aggrieved by a final decision of the Board in any matter shall have a right of appeal to the superior court pursuant to the provisions of Chapter 150A of the General Statutes. (1971, c. 832, s. 1; 1979, c. 448, s. 12.)

§143-465. Reciprocity; Intergovernmental cooperation.—(a) The Board may issue

any license required by this Article on a reciprocal basis with other states without examination to a nonresident who is licensed in another state substantially in accordance with any of the provisions of the Article, provided that financial security as provided for in G.S. 143-467 is met.

(b) The Board may cooperate or enter into formal agreements with any other agency of this State or its subdivisions or with any agency of any other state or of the federal government for the purpose of enforcing any of the provisions of this Article.

(c) In order to avoid confusion resulting from diverse requirements and to avoid increased costs to the people of this State due to the necessity of complying with such diverse requirements in the manufacture and sale of such pesticides, it is desirable that there should be uniformity between the requirements of the several states and the federal government relating to such pesticides. To this end the Board is authorized, after public hearing, to adopt by regulation such regulations, applicable to and in conformity with the primary standards established by this Article, as have been or may be prescribed with respect to pesticides by departments or agencies of the United States government. (1971, c. 832, s. 1.)

§143-466. Records; information; inspection; enforcement.—(a) The Board shall require licensees to maintain records with respect to the sale and application of such pesticides as it may from time to time prescribe. Such relevant information as the Board may deem necessary may be specified by regulation. Such records shall be kept for a period of three years from the date of the application of the pesticide to which such records refer, and shall be available for inspection by the Board or its agents at its request.

(b) The Board may publish information regarding injury which may result from improper application or use of pesticides and the methods and precautions designed to prevent such injury.

(c) The Board may provide for inspection of any equipment used for application of pesticides and may require repairs or other changes before its further use for pesticide application. A list of requirements that equipment shall meet may be adopted by the Board by regulation.

(d) The Board may provide for inspection of any place of business where pesticides are stored or sold and may require changes in methods of handling, displaying and storing of all pesticides. A list of requirements that places of business must meet may be adopted by regulation of the Board.

(e) For the purpose of carrying out the provisions of this Article, inspectors designated by the Board may enter upon any public or private premises at reasonable times, in order:

- (1) To have access for the purpose of inspecting the premises and any equipment subject to this Article and such premises on which such equipment is kept or stored;
- (2) To inspect lands actually or reported to be exposed to pesticides;
- (3) To inspect storage or disposal areas;
- (4) To inspect or investigate complaints of injury to humans, land or plants;
- (5) To sample pesticides being applied, or to be applied.

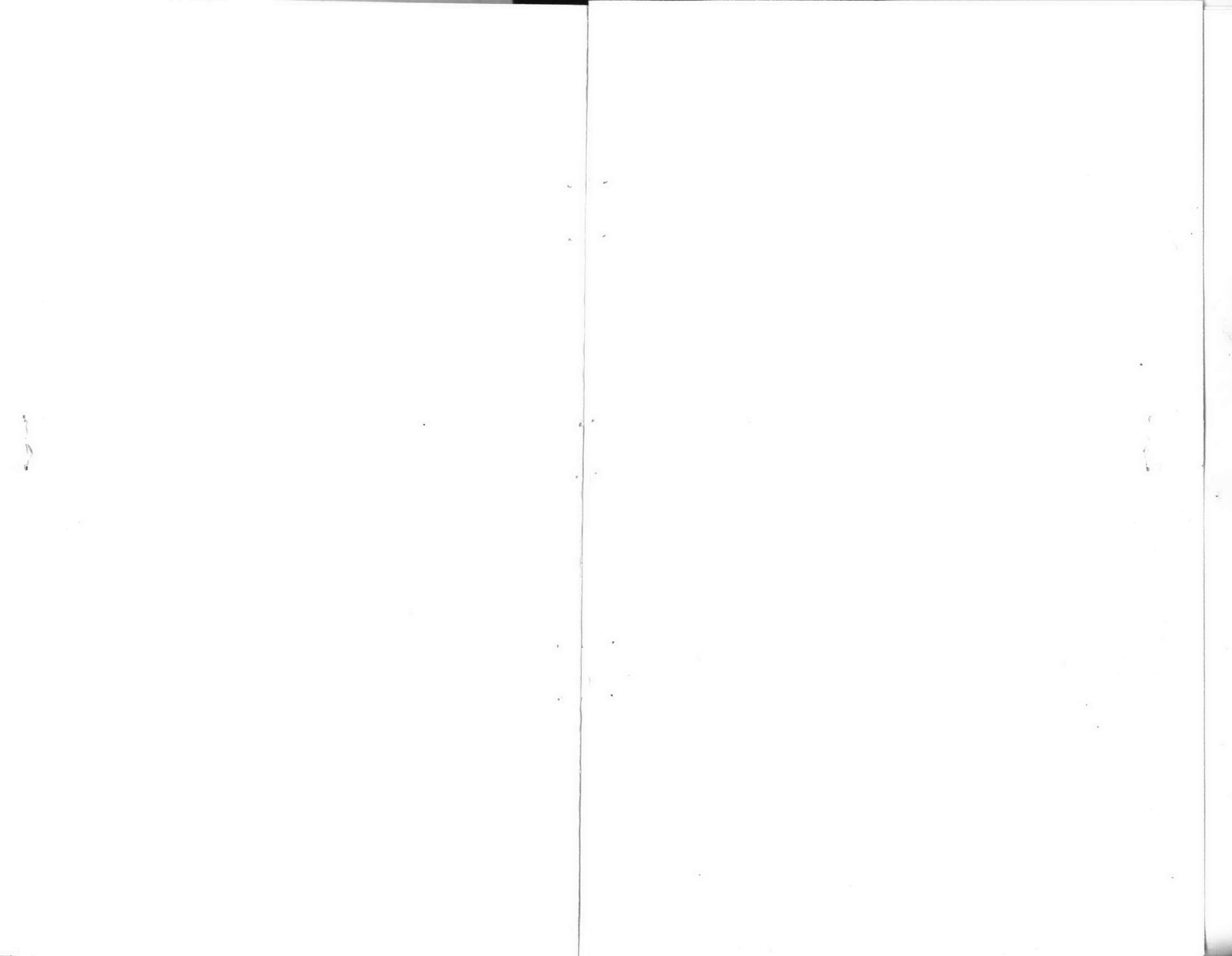

No person shall refuse entry or access to any authorized representative of the Board who requests entry for purposes of inspection, and who presents appropriate credentials, nor shall any person obstruct, hamper or interfere with any such representative while in the process of carrying out his official duties. Should the Board or its designated agent be denied access to any land where such access was sought for the purposes set forth in this Article, the Board may apply to any court of competent jurisdiction for a search warrant authorizing access to such land for said purposes. The court may upon such application issue the search warrant for the purposes requested. (1971, c. 832, s. 1.)

**§143-467. Financial responsibility.**—(a) The Board may require from a licensee or an applicant for a license under this Article evidence of his financial ability to properly indemnify persons suffering damage from the use or application of pesticides, in the form of a surety bond, liability insurance or cash deposit. The amount of this bond, insurance or deposit shall be determined by the Board, in light of the risk of damage. The indemnification requirements may extend to damage to persons and property from equipment used (including aircraft).

(b) The Board may also require a reasonable performance bond with satisfactory surety to secure the performance of contractual obligations of the licensee, with respect to application of pesticides. Any person injured by the breach of any such obligation or any person damaged by pesticides or by equipment used in their application shall be entitled to sue on the bond in his own name in any court of competent jurisdiction to recover the damages he may have sustained.

(c) Any regulations adopted by the Board pursuant to G.S. 143-461 to implement this section may provide for such conditions, limitations and requirements concerning the financial responsibility required by this section as the Board deems necessary, including but not limited to notice of reduction or cancellation of coverage, deductible provisions, and acceptability of surety. Such regulations may classify financial responsibility requirements according to the separate license classifications and subclassifications prescribed by the Board pursuant to G.S. 143-452 and the dealer category (Part 3 of this Article). (1971, c. 832, s. 1.)

**§143-468. Disposition of fees.**—All fees and charges received by the Board under this Article shall be deposited in the Department of Agriculture General Fund Budget for the purpose of administration and enforcement of this Article, with proper approved accounting procedures accounting for all expenditures and receipts. (1971, c. 832, s. 1.)

**§143-469. Penalties.**—Any person who shall be adjudged to have violated any provision of this Article, or any regulation of the Board adopted pursuant to this Article, shall be guilty of a misdemeanor, and for each violation shall be liable for a penalty of not less than one hundred (\$100.00) nor more than one thousand dollars (\$1,000) or shall be imprisoned for not more than 60 days, or both. In addition, if any person continues to violate or further violates any provision of this Article after written notice from the Board, the court may determine that each day during which the violation continued or is repeated constitutes a separate violation subject to the foregoing penalties. (1971, c. 832, s. 1.)

**§143-470. Provisional or interim licenses.**—The Board is hereby authorized to adopt regulations providing for the issuance of interim or provisional licenses to any or all categories of licensees under this Article. Such regulations, among other things, may waive any particular license requirements, may reduce any license qual-

ification or requirement, and may provide for the phasing of the effectuation of any license requirement. No interim or provisional license issued pursuant to this section shall have an expiration date later than December 31, 1973. (1971, c. 832, s. 1.)

**§143-470.1. Report of minor violations in discretion of Board or Commissioner.**—Nothing in this Article shall be construed to require the Board or the Commissioner to initiate, or attempt to initiate, any criminal or administrative proceedings under this Article for minor violations of this Article whenever the Board or Commissioner believes that the public interest will be adequately served in the circumstances by a suitable written notice or warning. (1979, c. 448, s. 13.)

## CHAPTER 66, ARTICLE 10

### *Fair Trade*

(The 1971 General Assembly amended §66-57 to eliminate pesticides from the provisions of Chapter 66, Article 10 of the General Statutes.)

**§66-57. Exemptions.**—This Article shall not apply to any contract or agreement between or among producers or distributors or, except as provided in subdivision (3) of §66-52, between or among wholesalers, or between or among retailers, as to sale or resale prices. This Article shall not apply to any prices offered in connection with or contracts or purchases made by the State of North Carolina or any of its agencies, or any of the political subdivisions of the said State. This Article shall not apply to any price offered in connection with or contracts or purchases respecting pesticides, as defined by G.S. 143-460. (1937, c. 350, s. 7; 1971, c. 832, s. 2.)

#### EDITOR'S NOTE:

The first 1971 amendment inserted "the North Carolina Pesticide Board."

The second 1971 amendment substituted "North Carolina Board of Architecture" for "State Board of Architectural Examination and Registration," substituted "Veterinary Medical Board" for "Board of Veterinary Medical Examiners," deleted "and" following "Nursing Home Administrators," deleted "and" preceding "the Wastewater Treatment," and added "and the North Carolina Board of Landscape Architects."

For article on administrative evidence rules, see 49 N.C.L. Rev. 635 (1971).

For note as to constitutionality of statutes licensing occupations, see 35 N.C.L. Rev. 473 (1957).

For comment on this Chapter, see 31 N.C.L. Rev. 378 (1953).

**Trustees of University Are Not Agency Governed by This Chapter.**—Certiorari lies to review an order of the board of trustees of the University of North Carolina affirming the suspension of a student from the University for cheating, since the board of trustees is not an agency in the legislative or judicial branches of the government, nor an agency governed by this Chapter, and, therefore, no other statutory provision exists for review of its actions. In re Carter, 262 N.C. 360, 137 S.E.2d 150 (1964).

Applied in North Carolina Bd. of Arch. v. Lee, 264 N.C. 602, 142 S.E.2d 643 (1965).

Cited in In re Hawkins, 17 N.C. App. 378, 194 S.E.2d 540 (1973).



1870  
1871  
1872  
1873  
1874  
1875  
1876  
1877  
1878  
1879  
1880

1881  
1882  
1883  
1884  
1885  
1886  
1887  
1888  
1889  
1890

1891  
1892  
1893  
1894  
1895  
1896  
1897  
1898  
1899  
1900

1901  
1902  
1903  
1904  
1905  
1906  
1907  
1908  
1909  
1910

1911  
1912  
1913  
1914  
1915  
1916  
1917  
1918  
1919  
1920

1921  
1922  
1923  
1924  
1925  
1926  
1927  
1928  
1929  
1930

1931  
1932  
1933  
1934  
1935  
1936  
1937  
1938  
1939  
1940

1941  
1942  
1943  
1944  
1945  
1946  
1947  
1948  
1949  
1950

1951  
1952  
1953  
1954  
1955  
1956  
1957  
1958  
1959  
1960

1961  
1962  
1963  
1964  
1965  
1966  
1967  
1968  
1969  
1970

Chapter 832, Section 4 of the 1971 Session Laws states that Article 4 (Insecticides and Fungicides), 4A (Insecticide, Fungicide and Rodenticide Act of 1947) and 4B (Aircraft Application of Pesticides) of Chapter 106 of the General Statutes are hereby repealed. The same section states that Article 4C (The Structural Pest Control Act of North Carolina of 1955) is NOT repealed.

Section 6 of Chapter 832 in the 1971 Session Laws states that no provision of this act is intended, nor shall be construed, to affect in any way any rights or interest (whether public or private):

(a) Now vested or accrued, in whole or in part, the validity of which might be sustained or preserved by reference to any provisions of law repealed by this act;

(b) Derived from, or which might be sustained or preserved in reliance upon, action heretofore taken (including the adoption of ordinances or resolutions) pursuant to or within the scope of any provision of law so repealed.

Section 7 of Chapter 832 of the 1971 Session Laws states that: (a) Notwithstanding any other provision of law, all existing rules and regulations concerning pesticides of the North Carolina Department of Agriculture and of any other department or agency of the State of North Carolina, not inconsistent with the provisions of this act, shall continue in full force and effect until repealed, modified or amended.

(b) No action or proceeding of any nature concerning pesticides (whether civil or criminal, judicial or administrative or otherwise) pending at the effective date of this act by or against or before the North Carolina Department of Agriculture or any other department or agency of the State of North Carolina shall be abated or otherwise affected by the adoption of this act, and Section 8 contains a severability clause.

The effective dates of this act are: (a) Parts 3 and 4 of Article 52 of Chapter 143, (b) G.S. 143-442 through 143-445 and (c) the repeal of Articles 4, 4A, and 4B of Chapter 106 of the General Statutes of North Carolina, January 1, 1972. The remainder of the act shall be effective October 1, 1971.

Chapter 1331 of the 1973 Session Laws rewrote Chapter 150 and was amended to read Chapter 150[A] of the General Statutes.

Section 12 of Chapter 425 of the 1975 Session Laws states that Section 143-455 shall become effective on January 1, 1976.

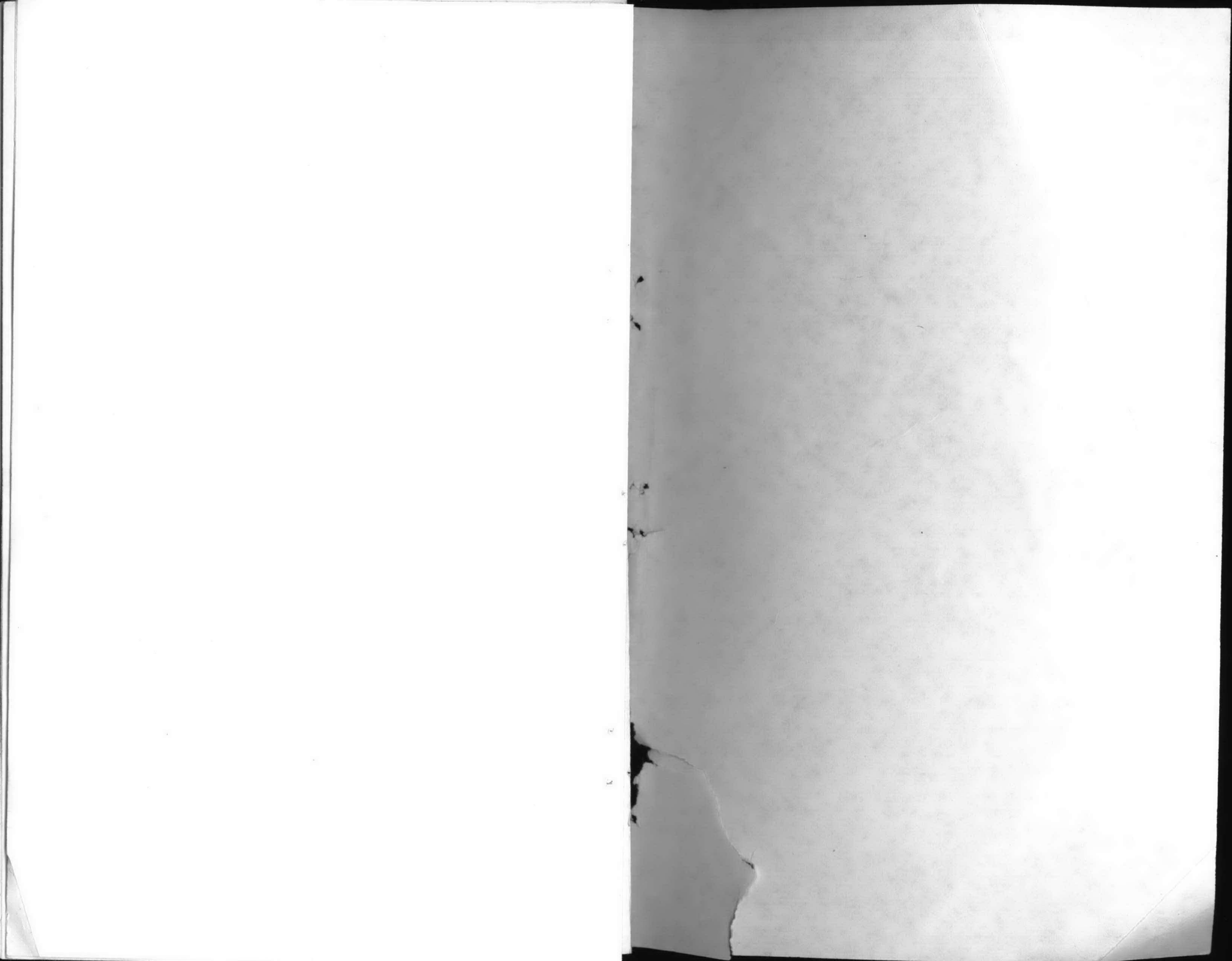

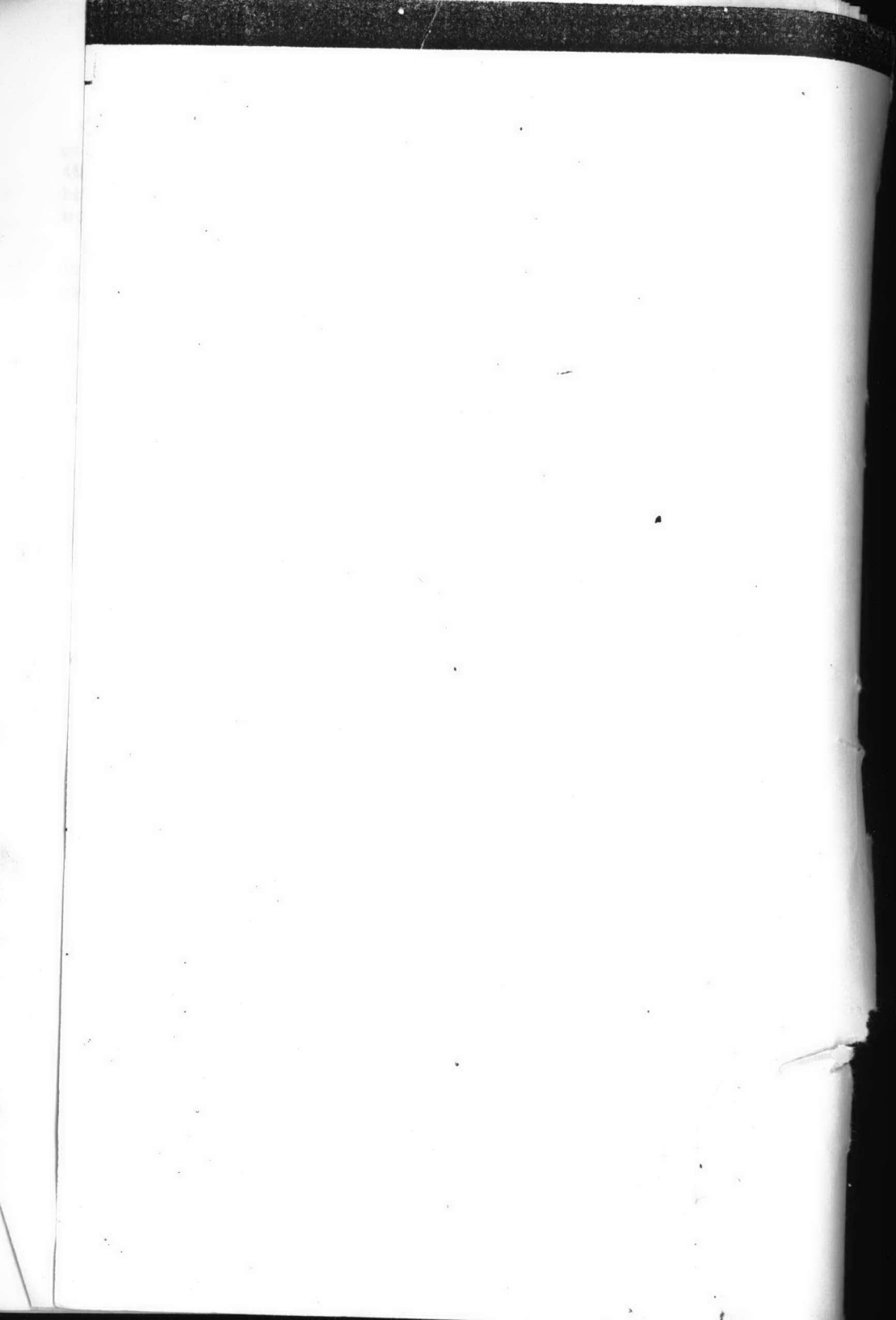

*del*  
6240/4

TECHNICAL INFORMATION MEMORANDUM NO. 17

\*\*\*\*\*

PEST CONTROL FACILITIES

\*\*\*\*\*



ARMED FORCES PEST MANAGEMENT BOARD

November 1983

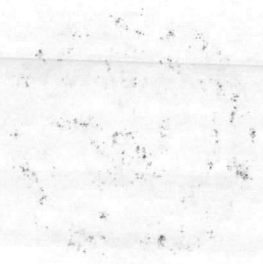

PEST CONTROL FACILITIES

Prepared by

ARMED FORCES PEST MANAGEMENT BOARD

AD HOC COMMITTEE ON PEST CONTROL SHOP DESIGN

Committee Members

Mr. W. A. Gebhart, Chairman  
Mr. D. R. Estes, LtCol D. A. Hadden, Mr. H. A. Shultz  
Mr. J. F. Smith, Mr. C. B. Spencer,  
and LtCol S. M. Valder

## FOREWORD

This Technical Information Memorandum (TIM) was developed from an evaluation of facilities in Department of Defense (DoD) installations, from surveys of the availability of new materials and construction methods, and from selection of the best design practices of government agencies and the private sector. This TIM uses to the maximum extent feasible, national professional society, association, and institute standards in accordance with DoD policy. Deviations from these criteria should not be made without prior approval of the Component's senior pest management consultant.

Design cannot remain static any more than can the DoD functions it serves or the technologies it uses. Accordingly, recommendations for improvement are encouraged from within DoD and from the private sector and should be furnished to the Armed Forces Pest Management Board, Forest Glen Section, Walter Reed Army Medical Center, Washington, D. C. 20307.

DoD components are encouraged to adopt the information contained herein as guidance for the design of pest control facilities.



CONTENTS

PEST CONTROL FACILITIES

	<u>Page</u>
SECTION A - PLANNING	
1. Purpose - - - - -	1
2. General - - - - -	1
3. Users - - - - -	1
4. Facility Size - - - - -	1
5. Location - - - - -	2
6. Cost - - - - -	2
7. Operational Procedures - - - - -	2
8. Environmental Concerns - - - - -	3
9. Collateral Equipment - - - - -	3
10. Bid Items - - - - -	3
11. Energy Conservation - - - - -	3
12. Building Protection - - - - -	3
13. Safety - - - - -	3
SECTION B - DESIGN CRITERIA	
1. Architectural - - - - -	4
a. Style - - - - -	4
b. Size - - - - -	4
c. Functional - - - - -	4
(1) Clean Areas - - - - -	4
(a) Entry/Vestibule - - - - -	4
(b) Office/Break Space - - - - -	4
(c) Equipment Closet/Cabinet - - - - -	4
(d) Utility Room - - - - -	4
(2) Chemical Handling Areas - - - - -	5
(a) Storage - - - - -	5
(b) Formulation/Mixing - - - - -	6
(3) Transitional Areas - - - - -	6
(a) Change Room - - - - -	6
(b) Lavatory and Toilet - - - - -	7
(c) Shower - - - - -	7
(d) Laundry - - - - -	7
d. Construction Materials - - - - -	7
(1) Foundations and Floors - - - - -	7
(2) Exterior Walls - - - - -	7
(3) Doors and Windows - - - - -	7
(a) Doors - - - - -	7
(b) Overhead Garage Door - - - - -	7
(c) Windows - - - - -	8
(4) Interior Partitions - - - - -	8
2. Structural - - - - -	8
3. Interior Design - - - - -	8
4. Site - - - - -	8
a. General - - - - -	8
b. Siting - - - - -	8

c.	Accessibility	8
d.	Grading	8
e.	Parking	8
f.	Fire Hydrant	9
g.	Security Fencing	9
h.	Outdoor Formulation Areas	9
i.	Washstands	9
5.	Mechanical	9
a.	General	9
b.	Plumbing	9
(1)	Disposal of Pesticides	9
(2)	Spills and Contaminated Water	9
(3)	Holding Tanks	9
(4)	Closable Drains	10
(5)	Sediment Trap	10
(6)	Wash Water	10
(7)	Sanitary Sewer System and Drains	10
(8)	Sink	10
(9)	Water Heater	10
(10)	Washer and Dryer	10
(11)	Back-Flow Prevention Device	11
(12)	Overhead Filling Spigot	11
(13)	Emergency Eye Lavage and Deluge Shower and Drain	11
c.	Heating and Cooling	11
d.	Air Conditioning	11
e.	Ventilation	11
(1)	Building	11
(2)	Chemical Handling Areas	12
(3)	Canopy or Hood Ventilation System	12
6.	Electrical	12
a.	Explosion Proofing	12
b.	Lighting	12
(1)	Fixtures	13
(a)	Indoor	13
(b)	Outdoor	13
(2)	Conventional Outlets	13
(3)	Security	13
7.	Fire Protection	13
a.	Fire Extinguishers	13
b.	Smoke Alarm system	13
c.	Sprinkler Systems	13
d.	Other Fixed Systems	13
e.	Interior Partitions	14
8.	Signs	14
REFERENCES		15

#### APPENDICES

I.	Engineering Design Data	16
II.	Plates	19
A.	Small Facility Floor Plan	
B.	Large Facility Floor Plan	
C.	Traffic Flow Diagram - Small Facility	
D.	Traffic Flow Diagram - Large Facility	
E.	Back Draft-Slot Type of Ventilation Hood	

## PEST CONTROL FACILITIES

### SECTION A - PLANNING

1. PURPOSE. The intent of this TIM is to provide the best available technology for basic design guidance of pest control facilities on Department of Defense installations. It is presented for use by experienced architects and engineers. The contents include design data for shops to provide for the storage and handling of pesticides and related pest control equipment.
2. GENERAL. Pest control shop facilities are subject to Environmental Protection Agency and Occupational Safety and Health Administration regulations. These and other criteria are listed in the references. Numerous other operational requirements, determined through experience, have been identified, and all information currently available on pest control facilities is provided herein. Requirements are presented as essential (mandated by federal regulation, consensus standard or justified by good practice) and recommended (in the interest of safety and health, cost effective operations, improved efficiency or unique operations). In this discussion, the terms "shall" and "should" equate to "essential" and "recommended" requirements, respectively.
3. USERS. The primary users of pest control facilities are the activity pest manager (APM) (responsible for the overall pest control program) and pesticide applicators (perform pest control operations).
4. FACILITY SIZE. Guidance on the actual size and components of pest control facilities should be based upon the pest management plan established for each installation. Facilities shall provide adequate space for personnel and equipment necessary to address installation pest problems. In general, a small facility will serve one to three pest controllers (See Facility Plate A), a medium sized facility serves four to nine controllers, and large facilities (See Facility Plate B) will serve ten or more persons. For essential space, the initial criteria are approximately 1,000 square feet for a small facility, with an additional 500 square feet for each additional pest controller over three. The additional increment diminishes as the number of controllers increases. A ten person facility should require no more than 3,000 square feet or 300 square feet each. Table 1 lists the approximate size of facilities up to 10 controllers. If two pest control functions (for example, engineering pest control shop and the golf course) require facilities, the design should be modified to include separate storage areas and with a second small office but share a common formulation room. Additional variations shall be included to plan for staffing and climatic differences and to comply with individual state or host country requirements for pesticide handling.

TABLE 1. FACILITY SIZE

Number of Personnel	Approximate Size (X 1,000 Sq. ft.)	Toilet Facilities
1 to 3	1.0 (small facility)	1
4	1.8 (medium facilities)	2 (may be
5	2.1 " "	" separate
6	2.3 " "	" to accom-
7	2.5 " "	" modate
8	2.6 " "	" both
9	2.8 " "	" sexes)
10	3.0 (large facility)	2 or more
	(or larger)	

5. LOCATION. Pest control shops contain toxic chemicals and may be required to provide interim storage for pesticides classified as hazardous wastes. Only isolated, single purpose structures should be constructed. Pesticide storage and formulation facilities that are integral parts of multiple-occupied buildings present actual and potential problems. Unless the pest control shop is very tightly sealed off from adjacent spaces, noxious vapors will permeate nearby spaces. Storage areas for hazardous pesticides are attractive to unqualified and unauthorized users. This creates unique security problems. When locating a facility in a multiple-use building is the only alternative, it shall be located on the end of the structure. This alternative is recommended only as an interim measure, and construction of a separate structure should be initiated.

6. COST. New pest control shops and associated facilities may easily exceed the Tower cost limit for Operations and Maintenance funding unless designed rationally. This is usually attributable to the high square footage costs for utility connections, specialized ventilation and required safety equipment. Small shops do not cost proportionately less since the major difference is in storage space, which is a less expensive consideration. It is essential that installations design and construct minimum sized facilities needed to meet their mission requirements.

Consideration shall also be given to future use of a pest control facility. If activity disestablishment or contracting out is anticipated, resources for a new pest control facility should not be obligated. Under certain situations the installation may be required to provide pest control facilities for contractor use. The policy should be that a cost study be completed to examine retention of the function in-house before construction or major rehabilitation projects are approved.

7. OPERATIONAL PROCEDURES. Several operational procedures apply to pest control functions which bear on the design of pest control facilities. These are identified in applicable sections by "Operational Note". Numerous other operational requirements, determined through experience, have been identified, and all information currently available on pest control facilities is provided or referenced.

8. ENVIRONMENTAL CONCERNS. Pest control facilities are subject to Environmental Protection Agency and Occupational Safety and Health Administration regulations. Pest control facilities must be planned with regard to environmental protection. The storage and use of pesticides is regulated by 40 CFR 165 and often by state or local pollution abatement regulations as well. The use of water to extinguish fires in pest control facilities generates hazardous liquid wastes which can readily contaminate materials, soil and ground water. Another concern is for the proper disposal of wastes generated with normal pest control operations. Pesticide spills and cleanup procedures are addressed in AFPMB Technical Information Memorandum #15. [Operational Note: A pesticide spill kit (requires approximately nine square feet), located in the formulation area, is essential. The kit should be conspicuously identified and made readily available for emergency use. The kit should be inventoried periodically to ensure completeness and condition of all contents (Ref. 40 CFR 165.10(d)(2)).]

9. COLLATERAL EQUIPMENT. Several items of collateral equipment are required and these are listed in the appropriate sections of this memorandum.

10. BID ITEMS. Bid items are listed in the appropriate sections of this memorandum.

11. ENERGY CONSERVATION. Energy conservation shall be a major consideration in the design of building envelopes, mechanical systems, and electrical systems for pest control facilities. Each building envelope shall be insulated to provide the minimum heat transmission ("U") factors practical to meet energy budgets.

12. BUILDING PROTECTION. The vehicle entrance to the pesticide area shall be protected from damage by vehicles and moving loads by the installation of concrete filled pipe guards, bumpers, railings, corner guards, and similar protective features.

13. SAFETY. Because of the hazardous nature of the many kinds of pesticides (insecticides, herbicides, rodenticides, fungicides, wood preservatives, etc.) stored and used in pest control facilities, it is essential that such materials be secured and available only to qualified individuals. Legal requirements concerning pesticide storage are established, and procedures are recommended under Title 40, Code of Federal Regulations, Part 165 promulgated in the Federal Register 39 FR 15236 on May 1, 1974.

## SECTION B. DESIGN CRITERIA

### 1. ARCHITECTURAL

a. Style (Character). Design the pest control facilities in accordance with individual service architecture documents.

b. Size. Obtain guidance on the actual size and components of pest control facilities from the cognizant pest management consultant. Definitive drawings are available for small and large pest control facilities and may be obtained through a request to the cognizant Command or Engineering Field District pest management consultant. These drawings should be modified for local requirements. See also Table 1 in Section A.

c. Functional. Arrangement of spaces and hallways shall allow workers to arrive in a clean area, dress for hazardous exposure in the change area, leave it through a chemical area doorway, and retrace their path at the end of the workday. It is essential that there be no direct access between the office and the chemical area and that doorways shall be arranged so that no pesticide need ever be carried through clean areas. It is essential that the mixing room be located adjacent to the storage area, and the equipment storage area (if indoors) be accessible to the locker room and the exterior. Traffic flow diagrams are provided as Facility Plates C and D. Divide the facility into the following areas:

(1) Clean Areas. Clean areas include a vestibule, office/break space, and utility room.

(a) Entry/Vestibule. Provide an entrance vestibule to conserve energy.

(b) Office/Break Space. An office space for one person to do paperwork is essential. Collateral equipment includes a desk, bookcase, file cabinet, telephone (essential) and a small table with one chair per worker (recommended). Heating, ventilation and air conditioning is recommended for effective workplace habitability. A break space is suggested in or adjacent to the office area but nowhere else. [Operational Note: Employees should not be allowed to eat in areas where pesticides are mixed, stored or handled. Where there is exposure to toxic materials, a food storage area that is physically separated from such materials must be provided. This applies to coffee areas as well as storage of lunch boxes or bags. Waste containers must be provided for the disposal of all waste food. Such containers must be equipped with covers and be in accordance with OSHA Regulations, Section 1910.141.)] Delete the office space from secondary shops if there is a primary pest control shop on the installation.

(c) Equipment Closet/Cabinet. Provide a space to store personal protective gear (new gloves, respirator cartridges, etc.).

(d) Utility Room. Provide a utility room to contain a hot water heater (see paragraph 5b(9) Section B), a washer and dryer (stack to conserve space) and janitorial supplies.

(2) Chemical Handling Areas. Chemical handling areas include pesticide storage and formulation rooms. This is the area of greatest exposure and hazard to applicator personnel from concentrated toxic materials.

(a) Storage.

1. General. Pesticide storage facilities are essential to safely protect and store pesticidal chemicals in various sizes of glass, metal, plastic and fiber containers. Storage areas shall be secured from unauthorized entry (essential). Minimum storage is approximately 500 square feet with an additional 50 sq.ft. per worker, again, diminishing as the number of personnel increases. Storage space may also be combined with, or accommodated in the garage space.

2. Indoor Storage. Pesticides shall be stored in an area sealed or separated from clean areas, and with access to the exterior. All pesticides stored indoors shall be off the floor so that all labels are visible and with lanes to provide effective access and inspection (Ref: 40 CFR 165.10(d)(1)). Insecticides should be separated from herbicides (Ref. 40 CFR 165.10(d)(1)). This is especially true for phenoxy herbicides. Pesticides shall be stored in a dry room or building where fire detection devices are provided and where temperatures above 40°F and below 100°F are maintained. Pesticide storage shall be separate from formulation areas, locker rooms, offices, or any area where personnel work for prolonged periods (essential). See paragraph 5e, Section B for ventilation requirements. Metal cabinets within the storage area are recommended for non-chemical equipment storage (bait, traps, drills, other tools, etc.). A mechanism for off loading drums and mounting sprayers on vehicles in the garage or storage area is suggested for medium or large pest control facilities. A work bench for equipment maintenance in the storage area and another in the formulation room are recommended. Non-absorptive shelving to hold small containers of pesticides, application equipment, etc. is essential. [Operational Note: Recommended practices for storage areas include:

- A clear, three-foot aisle or passageway.
- Containers of flammable or combustible liquids that exceed 30 gallons in volume must not be stacked one upon the other.
- Dispensing must be by pump or by self-closing faucet devices bearing UL, Factory Mutual, etc., approvals.
- All storage rooms and cabinets must be locked when not in use.
- Suitable fire control devices, such as proper types and sizes of portable fire extinguishers, must be available and adequately maintained.
- Leakage and spillage must be cleaned up.
- Adequate precaution must be taken against igniting flammable vapor through spontaneous combustions and through contact with open flames, hot surfaces, frictional heat, mechanical sparks, etc.]

3. Outdoor Storage. Pesticides stored outdoors shall be under cover and protected from radiant heating, freezing temperatures and moisture. All fumigants shall be stored outside of occupied buildings. [Operational Note: A building, apart from the main building, used for pesticide storage shall:

- Be a one-story structure.
- Be devoted principally to the handling and storage of flammable or combustible liquids.
- Have two-hour fire-resistant exterior walls.
- Have no opening within ten feet of the storage items.
- Meet requirements similar to those for indoor storage.]

(b) Formulation/Mixing. Provide a room with a work area to formulate or mix concentrated pesticides into ready-to-use formulations. Formulation rooms shall have electricity and hot and cold water. Non-absorptive shelves should be situated near the pesticide storage racks, drum stands, garage and exterior door and in the formulation areas. Pallets to hold pesticides off the floor are essential. Metal pallets are recommended. Steel stands to keep drums off the floor are recommended. The work area shall contain a fiberglass or a similarly chemically resistant sink with a contiguous self-draining drip-proof counter top at least five feet long, sideboard splash panel on back and an adjacent shelf for holding measuring devices and concentrates. An additional unhooded deep sink for washing small equipment, gloves, etc., is recommended for larger shops. Galvanized metal fixtures are acceptable. Extra non-absorbent shelving, 12" deep is recommended.

(3) Transitional Areas. Provide an area for changing clothes, a toilet, shower, locker, and a laundry.

(a) Change Room. The change room serves as a transition area between clean and chemical areas. It contains lockers for street clothing on one side, storage for work clothing (shoes, coveralls, caps, etc.) on the other side and a third area for protective equipment (respirators, etc.). The change room shall be accessible to the showers, toilets and laundry areas. Personnel locker space is essential. [Operational Note: Items of protective clothing and protective equipment shall be stored separately from pesticides. Personnel shall have at least three sets of work clothing per person, two pair of gloves, and one respirator with additional respirator cartridges. An extra set of clean clothing should be maintained in the pest control shop for each employee (Ref. 40 CFR 165.10(f)(1)).] It is essential that each individual have two lockers: one for street clothing and another for work clothing to preclude contamination of street clothing by work clothing or protective gear.



(b) Lavatory and Toilet. Provide at least one lavatory with adequate hot and cold water, preferably from a combination-supply fixture for every ten employees (men and women). Provide adequate toilet facilities (one water closet for a small shop designed so that male or female employees may use the same facility, and two water closets for medium to large shops. See also Table 1 in section A), and these should be located in the transitional area. These facilities are essential unless suitable toilet facilities are convenient, for example, in an adjacent building. [Operational Note: Individual hand towels of cloth or paper shall be provided in proper receptacles. Provide some sanitary means for the disposal of used towels. The provision of a towel for general or common use is prohibited. Roller towels, if properly maintained, are considered acceptable.]

(c) Shower. Provide a hot water shower for personal decontamination at the end of the day (Ref: 40 CFR 165.10(c)(4)). Additional shower stalls may be recommended for medium and large shops.

(d) Laundry. Provide a laundry area located in or adjacent to the change room. It is essential that change rooms have access to the office, the lavatory and shower, and the pesticide storage and formulation area.

#### d. Construction Materials

(1) Foundations and Floors. Foundations shall be slab on grade with continuous four inch high concrete curbs around the perimeter of the storage and formulation areas. Provide ramps for all door sills. The thickness of the slab shall be designed to accept live loads of 500 lb 55 gallon drums in the interior storage area and garage. For other areas existing standards suffice. A four inch concrete curb with ramp between the storage and formulation rooms is essential to contain spills and facilitate clean up operations. See Facility Plates A and B. The installation of utility, heating or ventilation ducting is prohibited in or below slabs. Concrete floors shall be finished with a non-absorbent, non-skid finish. The floors in both the storage and formulation areas shall be covered with non-skid epoxy sealant or otherwise made impermeable to absorption. Pesticide runoff and contaminated water must be prevented from entering the main drainage system in accordance with 40 CFR 165.10(c)(4). The change room and office floors may be tiled.

(2) Exterior Walls. Exterior walls shall be either pre-engineered, or constructed of masonry block. Wood construction shall not be used in chemical areas.

#### (3) Doors and Windows.

(a) Doors. Exterior doors shall be insulated, self-locking, self-closing and with waterproof weather stripping. Doors shall be kept locked to prevent unauthorized entry (Ref. 40 CFR 165.10(c)(1)). Provide a raised sill to all doors between the mixing and storage areas.

(b) Overhead Garage Door. Provide a nine foot high x ten foot wide insulated door with waterproof weather stripping. Higher doors may be required if vehicle-mounted mist application equipment is to be used in the activity pest management program. Provide a four inch raised sill for the garage doorway.

(c) Windows. Provide metal framed windows with double or triple glazed with a thermal barrier feature, where appropriate. Equip windows with interior security bars (mesh) if the facility is not enclosed (surrounded) by a climb-proof (security) fence as indicated in paragraph 4g.

(4) Interior Partitions. Partitions shall be gypsum board on metal studs extending to a gypsum board ceiling eight feet high.

2. STRUCTURAL. Construct facility of pre-engineered exterior walls and roof or masonry bearing walls and steel roof joists.

3. INTERIOR DESIGN. Coat interior partitions with non-absorbent finish from floor to ceiling in the chemical areas only.

#### 4. SITE

a. General. Isolate pest control facilities from congested areas for reasons of health and safety, fire protection, environmental protection and security. This is based on the similarity of requirements for the isolation of storage facilities for chemicals, flammable or explosive materials (hazards), and sewage treatment plants (vapors and odors). Pest control shops contain toxic chemicals and may be required to provide interim storage for pesticides classified as hazardous wastes in accordance with 40 CFR 165.10. The most compelling of reasons for isolation of pest control shops is fire safety. If a fire should occur in a shop within a building complex, extensive decontamination of nearby spaces from the drift of toxic vapors, smoke, liquids, and particulates will be required. This condition is confined to one structure when the shop is isolated. Isolated single purpose structures are essential.

b. Siting. Site pest control facilities a minimum of 200 feet from streams, other natural water sources, or 100 year flood plains. Siting a pest control shop downhill from the sensitive areas noted above, or diking is a suggested alternative where space is limited. They shall not be located uphill from potable water sources or continuously occupied structures. Facilities should not be sited over aquifers (subsurface potable water supplies) unless the aquifer is adequately protected through construction measures. Siting should be approved by an industrial hygienist or a sanitary engineer. Where siting requires that the facility be part of a multiple-use building (not recommended), it must be located on the end of the structure. Utility connection costs, access, security and subsurface conditions should be considered in siting. Funding limitations will not support excessive utility runs, long access roads or extensive site preparation costs. Select a site that, based on previous experience or soil tests, allows slab-on-grade construction.

c. Accessibility. Provide access to pest control facilities by vehicles carrying supplies or pulling trailer mounted dispersal equipment. The facility must be accessible to vehicles and pedestrians on at least two sides.

d. Grading. Runoff from fire-fighting must not reach standing water or other sensitive areas. Diking is recommended for large pest control facilities only.

e. Parking. Provide adequate space to park all pesticide dispersal equipment inside the pest control area, under cover in accordance with 40 CFR 165.10(c)(1). The entire compound will be gravelled or paved for the travel and parking of vehicles.

f. Fire Hydrant. Access to fire hydrants is not essential since it is usually safer to let pest control facilities burn down than to put the fire out with water and thereby generate considerable hazard from liquid wastes. Additionally, incineration eliminates toxic vapors and smokes that would otherwise pose a severe hazard to firemen and other exposed personnel. Access to fire hydrants should only be considered if the pest control facility is part of or near a larger structure worth protecting. If this is the case, it is recommended that siting requirements include having a fire hydrant within 350 feet.

g. Security Fencing. Provide a climb-proof fence, a minimum of seven feet high to prevent unauthorized entry. Gates to the fence shall be kept locked in accordance with 40 CFR 165.10(c)(1). The fence may be omitted when the facility is located in a secure area. In such situations, bars or heavy gauge wire mesh over the windows are required (see paragraph 1d(3)(c), Section B for security of windows). Provide a sign on the fence as indicated in paragraph 8, Section B.

h. Outdoor Formulation Areas. Provide an outdoor formulation area for medium and large pest control facilities consistent with provisions for the safe filling, formulation, and decontamination of vehicular and trailer mounted equipment (Ref. 40 CFR 165.10(c)(4)). See also paragraphs 4i below and 5b(12), Section B.

i. Washstands. Provide an outdoor washstand consisting of a curbed (four inches high) concrete pad sufficiently large enough to hold a truck and trailer (minimum 15' by 25'). [Operational Note: Washstands are recommended for use during cleaning or filling truck or trailer mounted dispersal equipment.] An elevated water fill pipe is essential.

## 5. MECHANICAL

a. General. Provide a ventilation system for the facility. Heating and air conditioning for effective workplace habitability may be required, depending upon the geographic area.

### b. Plumbing

(1) Disposal of Pesticides. The problem of disposal must also be considered. Disposal of small quantities of dilute pesticides into the sanitary sewage system is recommended unless otherwise prohibited by local water quality board regulations. The term "dilute" pesticide refers to the waste water generated from the daily laundry of work clothing, and the washing of protective equipment and small items of dispersal equipment. Waste water from emergency deluge showers and eye lavages may also be included. Small quantities in this context are interpreted as 50 gallons per day discharged into sanitary sewer systems with flow rates greater than 50,000 gallons per day.

(2) Spills and Contaminated Water. Design storage and formulation areas to contain spills and water. Pesticide spills and cleanup procedures are addressed in AFPMB Technical Information Memorandum #15.

(3) Holding Tanks. Do not design drainage to a holding tank. Holding tanks should be prohibited in new construction. Holding tanks are not recommended unless they are equipped with an in-line filtering system. [Operational Note: Procedures are available which preclude use of holding tanks. These include but are not limited to: (1) the practice of washing outdoor dispersal equipment at the application site and applying the wash water to the area treated, (2) saving wash or rinse water at the end of the work day to be used in the next days' formulation, and (3) substituting the more hazardous or toxic pesticides with safer, less persistent, biodegradable materials.]

(4) Closable Drains. Provide closable drains leading to the sanitary sewer to give adequate environmental protection against spilled concentrate pesticides or formulated compounds. [Operational Note: Drains are maintained in a closed position to prevent accidental introduction of spilled pesticides.] Determine before design and construction if drains to the sanitary sewer system are prohibited by state or local regulations.

(5) Sediment Trap. Provide a sediment trap in the drain lines from the storage and formulation areas.

(6) Wash Water. Provide drainage from indoor and outdoor wash stands to the sanitary sewer system. Wash water from dispersal equipment ranging from manually carried to trailer mounted items does not normally constitute a hazard to sewage treatment plants. [Operational Note: Adverse effects on the environment can be avoided by using wash water as the diluent for soil treatment for subterranean termites or dispersing the wash water over the same outdoor area where the initial pesticide was applied.]

(7) Sanitary Sewer System and Drains. Connect all plumbing fixtures to a sanitary sewer system, and ensure that only rain or snow-melt water is routed to storm drains. Pesticide wastes are generated routinely from equipment washdown, laundry of work clothing and personal decontamination. Other wastes may occur through disposal of unused pesticides at the end of a work day and, rarely, from actual pesticide spills. Disposal of dilute pesticides, except for very small quantities, into the sanitary sewage system is not recommended, and all disposal of pesticides may be prohibited by local water quality board regulations. Pesticide spills are addressed under "Closable Drains" (see paragraph 5b(4) above). [Operational Note: Water resulting from washing the exterior of dispersal equipment and vehicles may be drained into the sanitary sewer, provided standard operating procedures preclude release of concentrates or sprayer contents into the drain.]

(8) Sink. Provide a deep sink to fill and wash small equipment. It should handle items 24 inches high and standard five gallon cans (Ref: 40 CFR 165.10(c)(4)). Install the hot and cold water faucets so that an air-gap of at least two diameters (minimum of two inches) of discharge opening exists between the outlet of the faucets and the top rim of the sink. The sink should be connected to the sanitary sewer. Swing type spigots are recommended. Provide a hood or canopy designed to enclose the mixing operation as much as possible and to exhaust the vapors and dusts away from personnel. At least 2 linear feet of counter top shall be next to the sink.

(9) Water Heater. Provide a hot water heater if a source of hot water is not available.

(10) Washer and Dryer. Provide all plumbing connections and drains for washer and dryer (may be stacked). [Operational Note: It is essential that work clothing be washed in separate loads from uncontaminated clothing (Ref: 40 CFR 165.10(f)(1)).]

(11) Back-Flow Prevention Device. Install reduced pressure back flow prevention device in accordance with American Water Works Association (AWWA) Standard C506-69. Plumbing which provides a source of water for filling pesticide dispersal equipment tanks must be provided with a back flow prevention device so that a water hose attached to a faucet can be used to fill the spray tank. For activities which purchase water from municipal sources, install the device in conformance with local plumbing standards. Some communities prohibit such devices.

(12) Overhead Filling Spigot. Provide permanent overhead filling spigot (frost-free) at outdoor washstand with air gap between discharge orifice and the top of the dispersal equipment tank.

(13) Emergency Eye Lavage and Deluge Shower and Drain. Provide emergency eye lavage and deluge shower (gpm rating to meet Fed. Spec. WW-P-541/7A) with manually operated, delayed closing valves located adjacent to the mixing counter. A drain should be provided and the floor should slope toward it. An eye wash lavage and deluge shower are essential for emergency washing of individuals accidentally contaminated with pesticides (Ref: 40 CFR 165.10(c)(4)). A drain should be provided and the floor should slope toward it.

c. Heating and Cooling. Provide adequate heating and cooling for personnel using the facility. Northern and southern activities will require special heating, ventilation and air conditioning considerations. Connection to existing central steam system is generally preferred. However, remoteness of the site may make this option cost prohibitive. Compare with cost of an independent heating system. The storage area must be heated to 50°F and cooled below 100°F; other areas heated to a maximum of 68°F and cooled to a minimum of 78°F. Do not design for maintaining 40°F in the storage room with exhaust system running. An independent heating system for the storage room is unnecessary. Consider the following: (1)(central steam available) steam unit heaters for storage and perimeter radiation for other areas; (2)(remote site) electric unit heaters in storage and oil-fired furnace/forced hot air in other areas; and (3) oil-fired unit heaters. Other cost effective systems may include comfort heating in office, formulation or toilet areas and freeze protection in storage. Design structures for addition of unit air conditioning in office. Recirculated air shall not be used in chemical areas. Due to the above features, wall insulation shall be provided. The garage or vehicle storage area may be heated by electrical unit heaters, and the remainder of spaces may have forced hot air or electric heat, if cost effective. Heating and/or cooling systems shall be designed to supply 100 percent outdoor air and shall not be recirculated.

d. Air Conditioning. Military Department engineering standards should be used.

e. Ventilation.

(1) Building. In the interest of conserving energy required for heating, cooling and exhaust ventilation, room sizes of storage facilities should be minimized. Wall mounted exhaust fans shall not direct exhaust air directly over sidewalks, or be less than the height provided by local building codes. Equip facility with an outside air louver with a gravity damper. All offices and eating areas shall be designed in such a manner as to preclude contamination with pesticide vapors. Normal ventilation in office and locker room is suggested. All entrances to the facility should be posted, warning that the facility should be ventilated continuously during occupancy. Wall mounted exhaust fans are recommended to minimize roof penetrations. General room make-up and local exhaust make-up air systems should be separate to allow shut-down of local exhaust ventilation systems when pesticides are not exposed.

(2) Chemical Handling Areas. Provide an exhaust air ventilation system which provides at least six fresh air changes per hour. This ventilation system need only operate when the storage/formulation areas are occupied. The light and exhaust switch with a pilot light shall be located outside the door and marked with a sign reading "OPERATE VENTILATION SYSTEM DURING OCCUPANCY". An outside air louver with gravity damper shall be installed above exterior doors. Where work areas are adjacent to storage areas and interfacing doors exist, the storage area must have a negative pressure (when occupied) with respect to adjacent areas. Ventilation in the formulation area shall be tempered systems supplying 100% outside air. All exhaust devices shall have two-way switches with one in the clean area. Negative pressure in formulation area relative to the rest of the shop and adjacent structures, if any, is essential.

(3) Canopy or Hood Ventilation System. The actual area for mixing pesticides shall be designed with local exhaust ventilation to contain, capture and exhaust toxic vapors and dusts (i.e., pesticide and solvent vapors). Facility Plate E provides a schematic drawing and specification for local exhaust ventilation of the back draft-slot type. The height (2 ft.) of this ventilation system should be designed to accommodate containers normally used by pest controllers. Where a sink is used for mixing, a hood that encloses the sink on both sides and exhausts from the rear or top should be utilized. The bottom of the hood should be 6"-12" above countertop and fitted with end baffles. Negative pressure in the formulation area is created by an exhaust system or hood located over the mixing counter. Additional exhaust systems may be needed depending upon the size of the space. It is essential that "drag-through" from wall exhaust systems is prohibited. Motorized louvers are suggested for the exhaust hood and exhaust fan(s). The exhaust hood shall provide an air velocity of 150 linear feet per minute (fpm) at the face of the hood (OSHA 1910.106). Baffles or plenums should be used to maintain a uniform face velocity (150 fpm + 30 fpm variation) at the hood opening or at the outer edge of the counter or sink top. If multiple stacked slots are used, then those slots closest to the plenum will have a higher air volume (cfm) unless provisions are made to insure that the lower slots provide 150 fpm capture velocity at the outer edge of the counter or sink top. A bypass sash or door between the worker and the material being mixed may be used to restrict the size of the hood opening and further protect the worker. Note: For upgrading existing facilities, exposure hazards from toxic vapors

shall eventually be engineered out with the installation of an exhaust fan or duct directly opposite the mixing surface from the worker. Personal protective equipment (respirator, face mask or shield, gloves, apron and work clothing) may be used to provide interim protection during formulation operations, but proper engineering controls, such as hooded ventilation systems, must be ultimately installed.

6. ELECTRICAL. Work shall be in accordance with the National Electric Code.

a. Explosion Proofing. Pesticide concentrates ordinarily used in structural pest control work have flash points above 140°F. That is, they may be combustible (flashpoint above 100°F) but are not flammable (flashpoint below 100°F) products. A hazardous area classification is not applicable if flammable pesticides (flash point below 100°F) are not stored or used. [Operational Note: Explosion proofing can be avoided by not using (or storing) any pesticides with flash points less than 100°F.]

b. Lighting. Military Departments engineering standards should be used except as follows:

(1) Fixtures.

(a) Indoor. Switching for the exhaust hood shall be located adjacent to counter. Lighting in the shop shall be at least: 50, 15 and 20 foot candles in the office and formulation rooms, storage area and washroom, respectively (Illumination Engineering Society). Use of corrosion resistant fixtures (raceways, receptacles, etc.) is recommended due to the effects of pesticidal chemicals.

(b) Outdoor. None required.

(2) Conventional Outlets. [Operational Note: Appliances commonly found in offices including electric heat, microwave ovens, coffee makers, etc. are the responsibility of the government, regardless of ownership, and shall comply with OSHA standards.]

(3) Security. Outside security lighting should be considered. This may be a bid item.

7. FIRE PROTECTION

a. Fire Extinguishers. Provide a fire extinguisher by the door between the storage and mixing areas in accordance with 29 CFR 2910.106.

b. Smoke Alarm System. Provide a smoke alarm system connected to the fire department.

c. Sprinkler Systems. Do not install systems in chemical areas due to potential for environmental damage from contaminated water. Single point sprinklers are recommended if a system is installed.

d. Other Fixed Systems. Not recommended. The installation of other fixed systems in chemical areas can be avoided by limiting the types of pesticides in storage to compounds with flash points of 100°F or more (fixed

fire protection systems are not required if flammable liquids are not used or stored). [Operational Note: It is far more practical to eliminate the few flammable pesticides in use (substitutes are available) than provide fixed fire-fighting systems and explosion-proof equipment, fixtures, etc. Where pesticides with flash points below 100°F must be used, fire protection can be provided with specialized lockable storage cabinets. After construction of a pest control facility, subsequent operating procedures, detailed in the installation pest management plan, must identify pesticides suitable for the level of fire protection provided in the facility]. Storage areas of combustible and flammable liquids (pesticides) must be segregated from other storage areas. Depending on the amount of liquids stored and the flash point, special handling and storage are necessary. If no more than 60 gallons of flammable or 120 gallons of combustible liquids are stored, a storage cabinet of metal or wood, as described in the regulation, will be adequate. If larger quantities are to be stored, a separate room, outside metal shed, or warehouse meeting the required fire resistant rating of the material must be provided. If this is your particular case, it would be advisable to seek additional guidance on fire protection (Ref. OSHA Regulations, Section 1910.141). The storage cabinets may be bid items.

e. Interior Partitions. Provide one hour protection. See paragraph 1d(4), Section B.

8. SIGNS. Provide identification signs such as "DANGER", "POISON", and "PESTICIDE STORAGE" on appropriate rooms, buildings, and fences to advise personnel of the contents and warn of their hazardous nature (Ref. 40 CFR 165.10(c)(2) and (g)(2)(i)). [Operational Note: a. If the facility is used also to store hazardous materials or toxic substances, a list of the types of materials shall be posted on the outside of the storage area (Ref. 40 CFR 165.10(g)(2)(ii)). b. All movable equipment used for handling pesticides which might be used for other purposes should be labeled "contaminated with pesticides" and should not be removed from the site unless thoroughly decontaminated.] Install a sign over the sink which reads: "DO NOT DISCHARGE PESTICIDES OR PESTICIDE SOLUTION INTO THE SINK". The exterior of the building shall display warning signs. Unless hood ventilation is provided, a sign shall be posted at the actual mixing area requiring the use of protective gloves, aprons and boots, protective eye wear or face shields, coveralls, and an approved pesticide respirator. All pesticide containers shall be labeled. Signs should be bilingual where applicable.



## REFERENCES.

1. American Conference of Governmental Industrial Hygienists (ACGIH). Industrial Ventilation - A manual of recommended practice, 13th Edition. ACGIH, Committee on Industrial Ventilation, P. O. Box 453, Lansing, MI.
2. American National Standards Institute (ANSI) Standard Z9.2-1960. The Design and Operation of Local Exhaust Systems, (ANSI), Inc., 1430 Broadway, New York, NY 10018.
3. National Institute for Occupational Safety and Health (NIOSH), Certified Personal Protective Equipment, Health Education and Welfare (HEW) Publication No. (NIOSH) 75-119 and Cumulative Supplements September 1974, January 1975 and June 1975. U. S. Department of Health, Education and Welfare, Public Health Service, Center for Disease Control, National Institute for Occupational Safety and Health, Morgantown, WV 26505.
4. American National Standards Institute (ANSI), Standard Z88.2 of 1969, Practices for Respiratory Protection, (ANSI), Inc., 1430 Broadway, New York, NY 10018.
5. U. S. Environmental Protection Agency, 40 Code of Federal Regulations 165, Regulations for the Acceptance of Certain Pesticides and Recommended Procedures for the Disposal and Storage of Pesticides and Pesticides Containers, Federal Register, 39(85):15236, May 1, 1974.
6. Armed Forces Pest Management Board, Technical Information Memorandum # 15, Pesticide Spill Prevention and Management, September 1980.
7. American Water Works Association (AWWA) Standard C506-69, Back Flow Prevention.
8. Occupational Safety and Health Regulation, 29 CFR 1910.
9. National Electrical Code.
10. Illumination Engineering Society Standard.
11. National Fire Protection Association.
12. National Pest Control Association manual, Profit Through Safety, October 1981.

APPENDIX I.

Engineering Design Data

ARCHITECTURAL

1. For guidance in the selection of small, medium, or large facility sizes, see Table 1 on page 2.
2. Provide exterior design and siting to suit project requirements. Provide air lock vestibule for large facility. Also, consider canopy and air lock at entrances of small and medium facilities to suit climatic conditions.
3. Pest control facilities should comply with National Pest Control Association (NPCA) manual, Profit Through Safety, October 1981.
4. Total Gross Area
  - a. Small Facility 1,064 SF (99 m<sup>2</sup>) - See Plate A.
  - b. Large Facility 3,024 SF (281 m<sup>2</sup>) - See Plate B.

MECHANICAL

1. Plumbing:

	<u>Small</u>	<u>Large</u>
Cold Water	38 GPM	41 GPM
Hot Water Recovery Rate (through 65° rise)	50 GPH	65 GPH
Storage	60 Gallons	80 Gallons
Maximum Temperature	105°F	105°F

\*2. Heating: Small facility outside design temperature: Typical design loads in MBH at various outside design temperatures:

-50F	+50F	+150F	+250F
210	181	154	126

Large facility outside design temperature: Typical design loads in MBH at various outside design temperatures.

-50F	+50F	+150F	+250F
380	330	280	230

Inside design temperature: 68°F minimum for small and large facilities (exclude mech. rooms, pesticide, tools, vehicle and equipment storage).

\*Refer to military Department engineering standards. The indicated design loads are from NAVFAC P-89, Engineering Weather Data.

60°F minimum for mech. rooms, pesticide, tools, vehicle and equipment storage.

3. Cooling: Inside design conditions: 78°F minimum for small and large facilities (excluding mech. rooms, pesticide, tools, vehicle and equipment storage).

90°F maximum for mech. rooms, pesticide, tools, vehicle and equipment storage.

4. Requirement: Install window type A/C in office only. Heat gain for small facility = 4200 Btuh. Heat gain for large facility = 11,500 Btuh.

5. Ventilation: Heating loss at various outside design temperatures, as indicated above, includes heat loss of exhaust hood located in the mixing room. The estimated exhaust hood dimensions for small facility are: 2'Wx6'L and for large facility dimensions are: 2'Wx8'L.

Pesticide Formulation and Mixing Room (small & large)	Minimum six air changes/hr. Exhaust 100% directly to outdoors
Laundry & Cleaning Gear (large)	Minimum 1-5 air changes/hr. Exhaust 100% directly to outdoors

Notes:

1. Mechanical utility requirements indicated alone are for estimating purposes only.
2. All mechanical equipment and fixtures shall be specified to withstand the corrosive atmosphere.

ELECTRICAL

1. <u>Lighting</u> :	Small	Large
Connected Load	2.0 KW	4.5 KW
Estimated Demand	1.0 KW	2.0 KW
2. <u>Power</u> : (see note 2 below)		
Connected Load	16.0 KW	43.3 KW
Estimated Demand	14.1 KW	28.5 KW
3. <u>Total</u> :		
Connected Load	18.0 KW	48.8 KW
Estimated Demand	15.1 KW	30.5 KW

Notes:

1. Electrical utility requirements indicated above are for estimating purposes only.
2. All electrical equipment and fixtures shall be specified to withstand the corrosive atmosphere.

FIRE PROTECTION

The CO<sub>2</sub> fire extinguishers shall comply with the provisions of Chapter 3, Section 4, NPCA manual Profit Through Safety.

APPENDIX II.

PLATES

PEST CONTROL FACILITIES



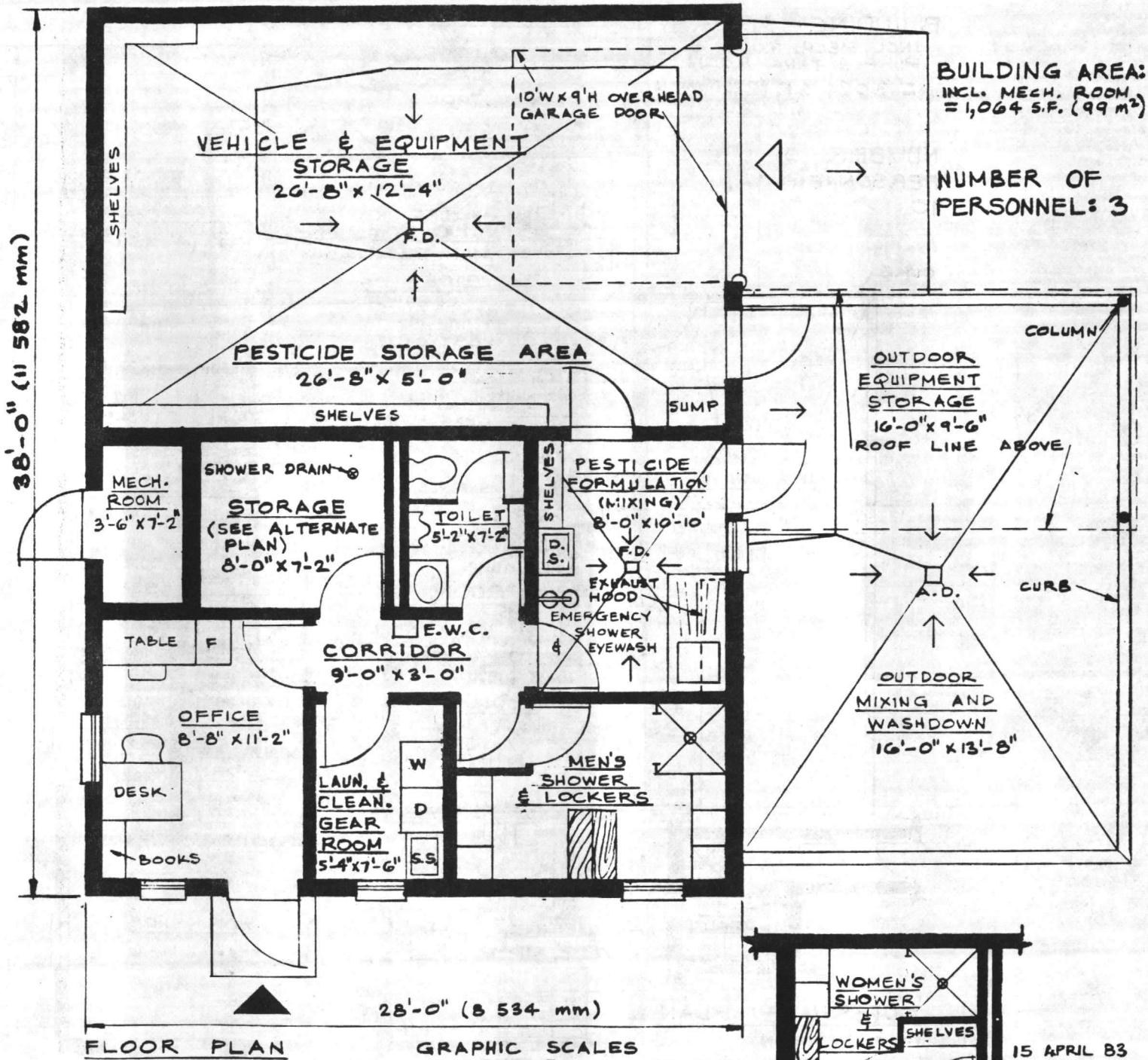

**PEST CONTROL FACILITY (SMALL)**

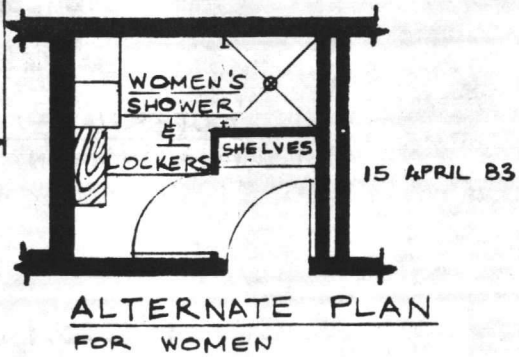

**BUILDING AREA:**  
 INCL. MECH. ROOM &  
 PUMP & TANK ROOM  
 = 3024 S.F. (281 m<sup>2</sup>)

**NUMBER OF  
 PERSONNEL:**  
 10

CURB

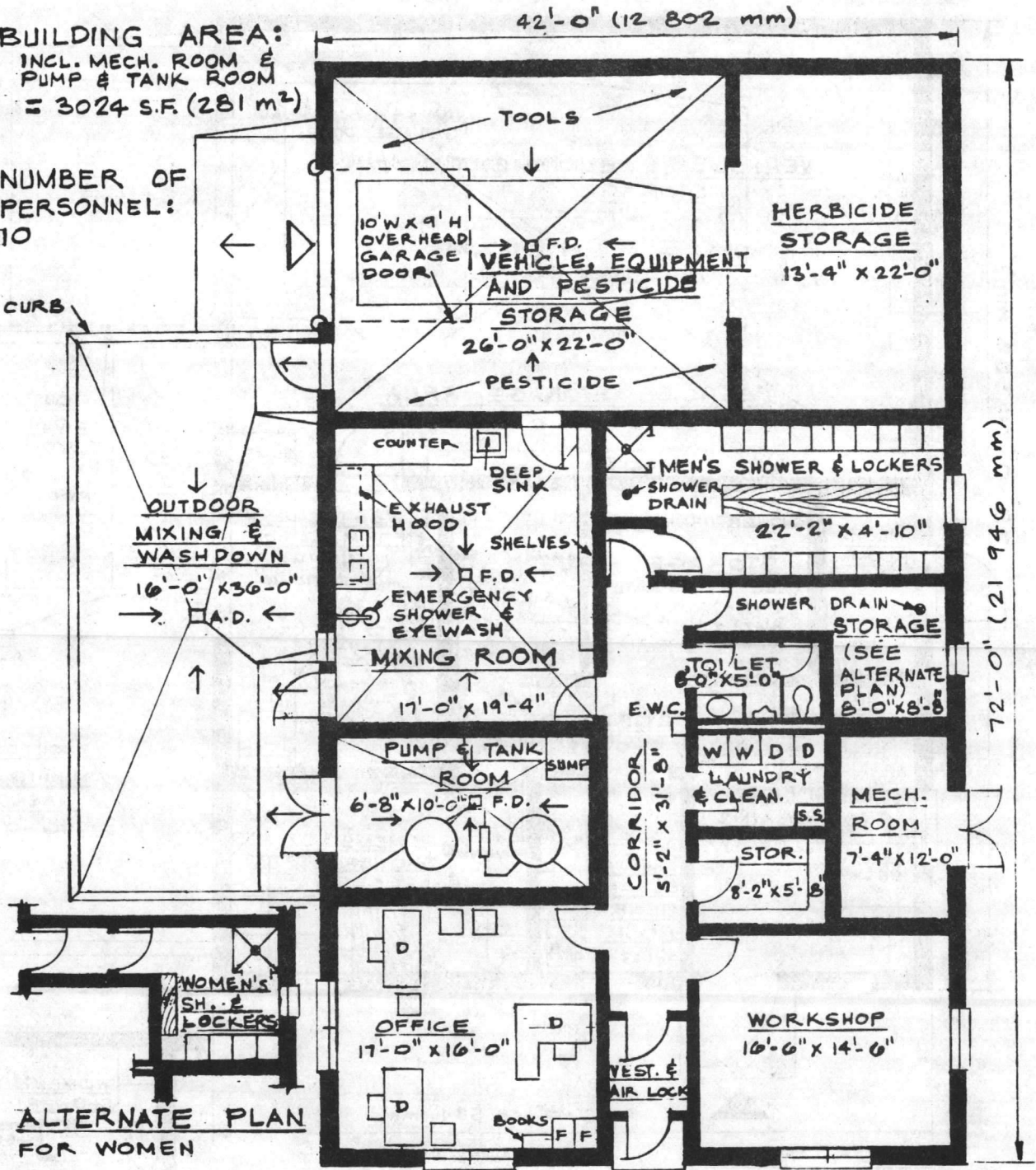

**FLOOR PLAN**

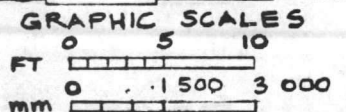

**PEST CONTROL FACILITY  
 (LARGE)**

15 APRIL 83



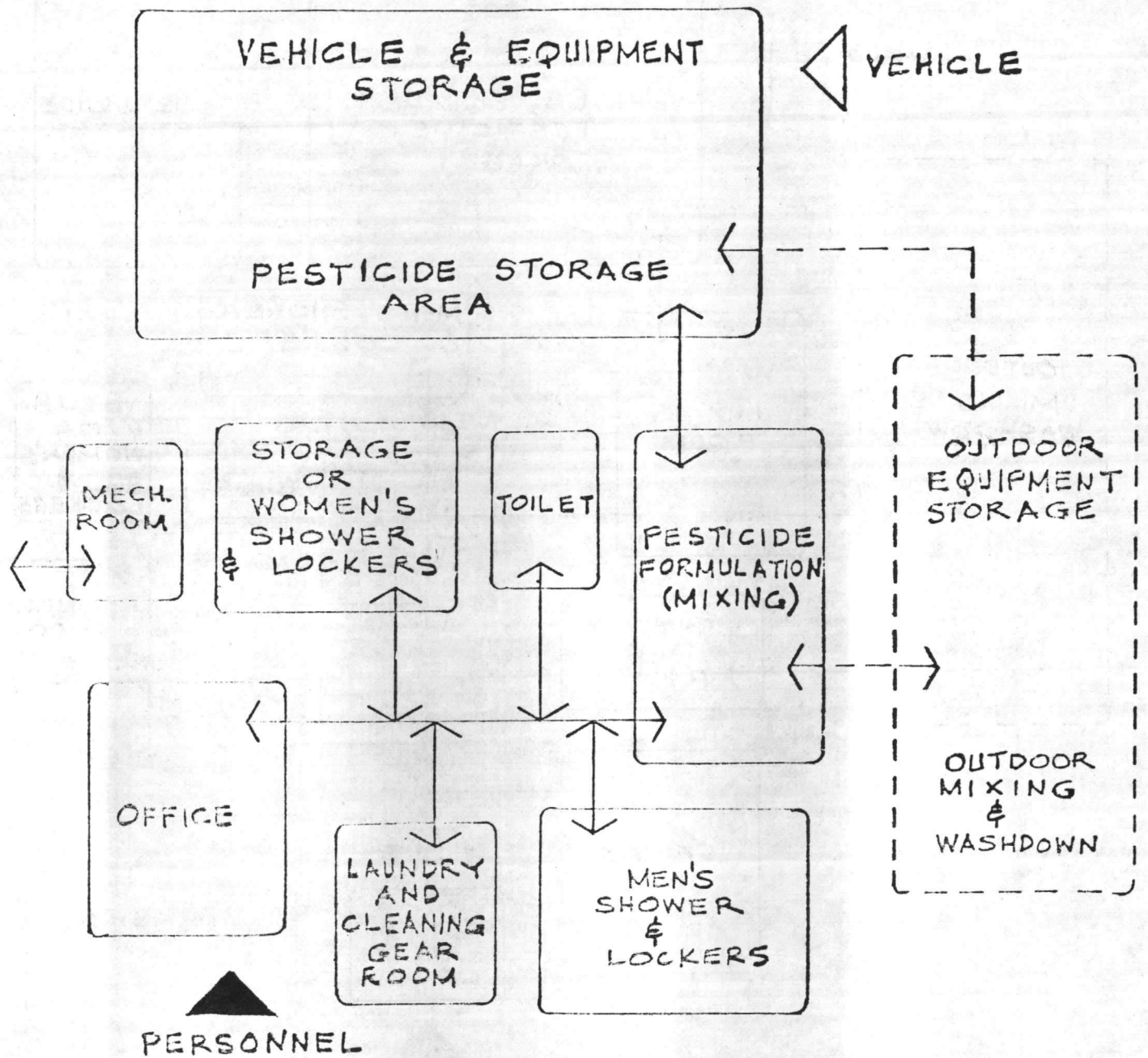

LEGEND

- BASIC FUNCTION
- ↔ BASIC CIRCULATION
- [ ] OUTDOOR FUNCTION
- ↔ OUTDOOR CIRCULATION

22 FEB 83

TRAFFIC FLOW DIAGRAM FOR  
SMALL PEST CONTROL OPERATIONS

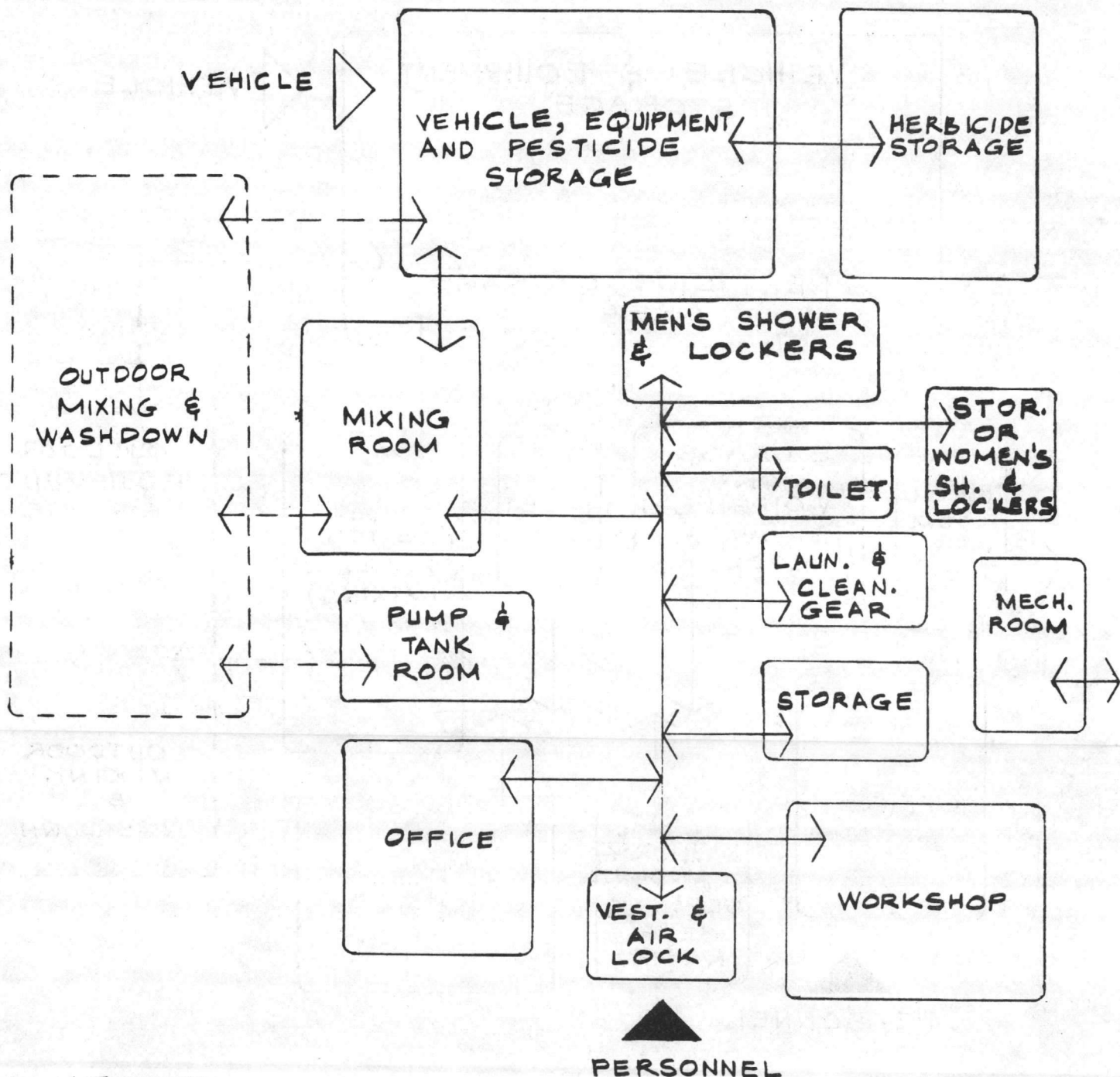

LEGEND

- BASIC FUNCTION
- ↔ BASIC CIRCULATION
- ⋯ OUTDOOR FUNCTION
- ↔ OUTDOOR CIRCULATION

4 APRIL 83

TRAFFIC FLOW DIAGRAM FOR  
LARGE PEST CONTROL OPERATIONS

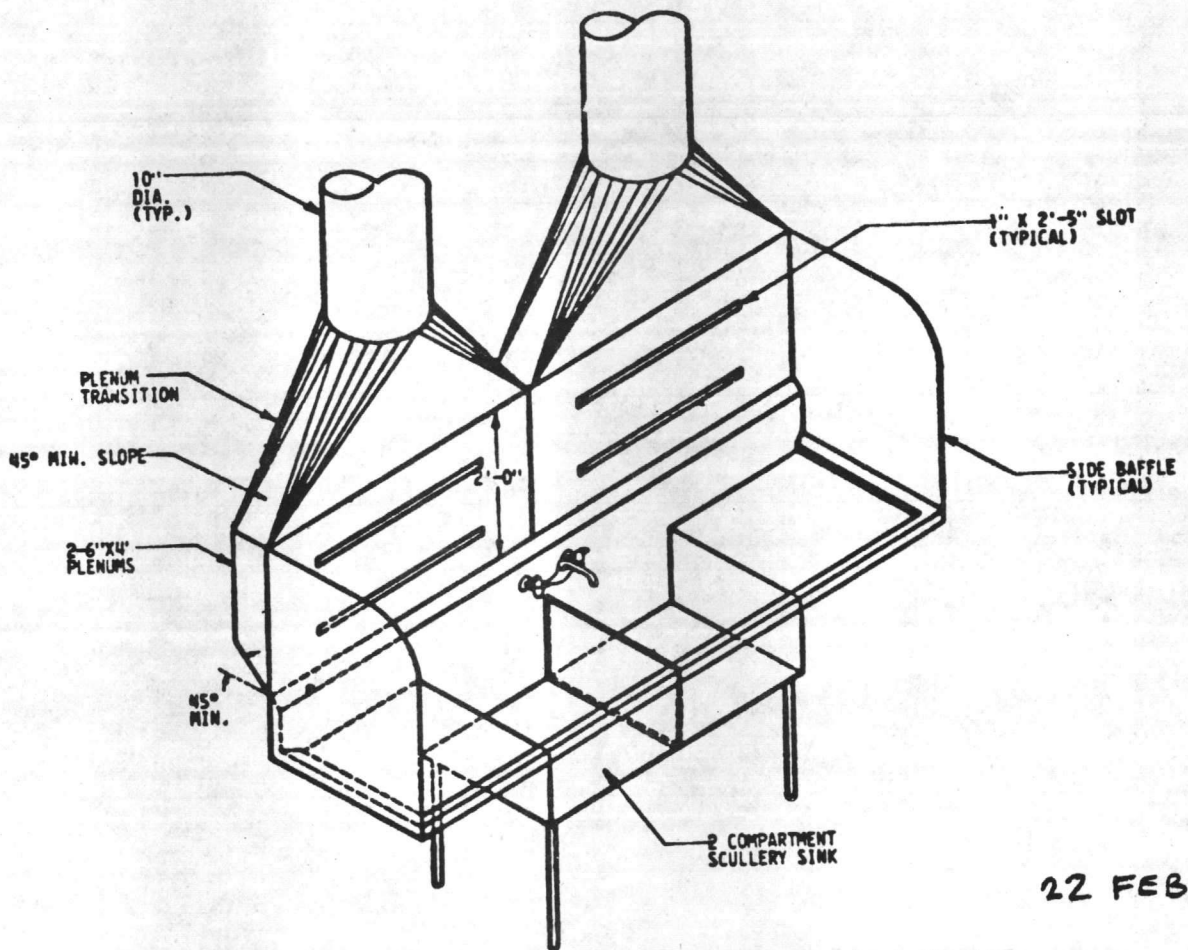

22 FEB 83

EXHAUST HOOD DETAIL FOR LARGE  
PEST CONTROL FACILITY  
 N.T.S.

NOTE:

PROVIDE 1 COMPARTMENT SCULLERY SINK AND  
 1 EXHAUST HOOD FOR SMALL AND MEDIUM  
 SIZED PEST CONTROL FACILITIES



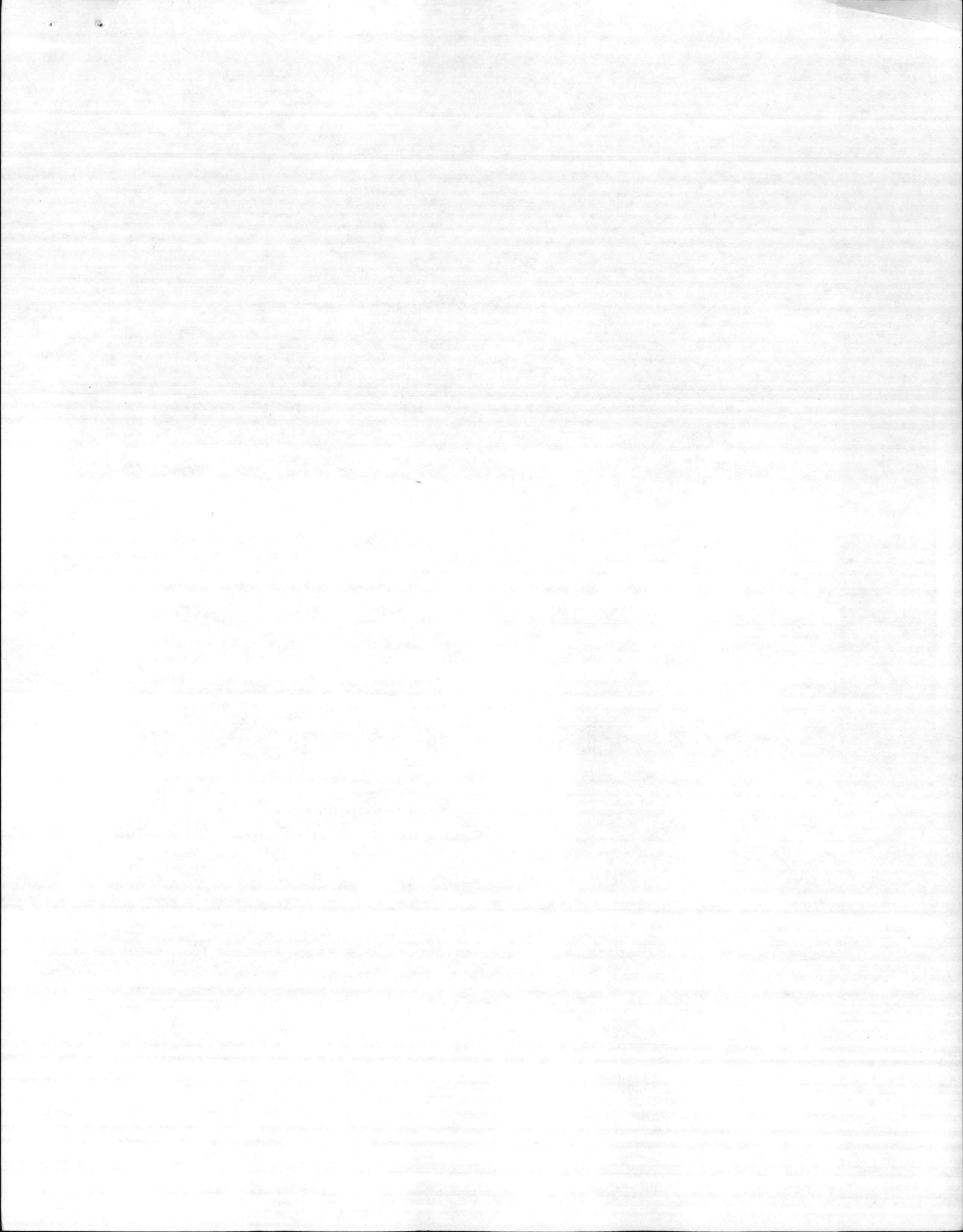





DEPARTMENT OF THE NAVY  
NAVAL HOSPITAL  
CAMP LEJEUNE, NORTH CAROLINA 28542-5008

Glenée



IN REPLY REFER TO

6260.3g9

371

4 May 87

From: Commanding Officer  
To: Commanding General, Marine Corps Base, Camp Lejeune, NC 28542  
(Attn: AC/S Facilities Department)

Subj: SUBSTITUTION OF HAZARDOUS MATERIALS

Ref: (a) CO, NHCLNC ltr 6260.3g9, 371, dtd 5 Feb 87

1. In reference (a), the Industrial Hygiene Branch requested that Material Safety Data Sheets (MSDS) on possible substitutes for materials containing suspect human cancer-causing substances be sent to this office for review before the materials are actually purchased.
2. The MSDS's on "Sure Shot" and "Big Kill", manufactured by Pro Chem, Inc. were received and reviewed. No information was found to indicate that these materials contain suspect human cancer-causing substances. If these materials are to be substituted, personnel should wear goggles and gloves when using them and make sure areas of use are well ventilated.
3. Please continue to make substitutions where possible and forward the MSDS's to the Industrial Hygiene Branch for review.
4. Contact Mr. J. Jones, Industrial Hygienist, at extension 2707 for continued assistance.

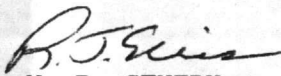
for   
M. P. GENTRY  
By direction

Copy to:  
Shop 76  
Insect Vector Control  
Base Safety





Glenice

2:00

What Chemicals?  
How you plan to do it?

Concentration

I. Major Gray

DI

**DIQUAT**

- dibromide (6-7-dihydrodipyrido  
1,2, a:2,1 c) pyrazinediium dibromide

Review projects

Copy label

Key

Send

Called Kellum about  
Told him to direct a letter

Jim Grimmett:

Is it feasible <sup>And Acceptable</sup> <sup>legal</sup> to  
Control vegetation at line  
along River Near Bld. 22  
with herbicides: Get  
with Major Gray -

lets discuss  
first.  
D. Stange

Class

00

4

Copy label

DIETARY

DI

(chirgibitlyb-7-ehmordib -  
H2, n: 3, 1, 2) gressio gii mnd pnd

...

Callen Kellan about  
Toll free to guest on letter

Glenice

2:00

What Chemicals?  
How you plan to do it?

Concentration

I. M. Gray

DI

**DIQUAT**

Copy label <sup>Key</sup> ~~Send~~  
dibromide (6-7-dihydrodipyrido)  
1,2, a: 2, 1 c) pyrazinediium dibromide

Review projects

Called Kellum about  
Told him to direct a letter

Case 1

1. 1st visit - 10/10/10

Copy label

DI  
TAVAT

DI

(1st visit - 10/10/10)

(1st visit - 10/10/10)

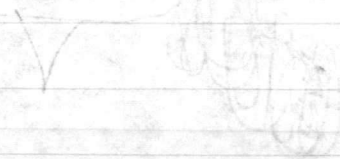

Called Kellman about  
Toll him to meet on 10/10/10

ROUTINE

031937Z JUN 87

FM DRMR MEMPHIS TN//DRMR-MOH//

TO AIG 4544

UNCLAS DRMR-MOH 179-87

SUBJ: 2, 4, 5-T, SILVEX AND DINOSEB PESTICIDE PRODUCTS FOR IDENTIFICATION AND DISPOSAL OPTIONS.

1. 8 APR 87, FEDERAL REGISTER-1139-11333 REGARDING 2,4,5-T AND SILVEX.

2. 15 APR 87, FEDERAL REGISTER 12352-12358 REGARDING DINOSEB.

3. 12 MAY 87, MEMORANDUM FROM DEPUTY ASSISTANT SECRETARY OF DEFENSE (ENVIRONMENT). (NOTAL).

4. 27 MAY 87, MESSAGE FROM DRMS-HQ (NOTAL).

5. REFERENCES A AND B SET FORTH GUIDELINES FOR IDENTIFICATION AND/OR DISPOSAL OF SUBJECT PESTICIDES AND HAS ESTABLISHED A 30 DAY DEADLINE FOR SUBMISSION OF PROPER PAPERWORK. REFERENCE C NOTES THAT THE ACTUAL INVENTORY/DATA RECORDING BE ACCOMPLISHED BY INSTALLATION PERSONNEL AND SUBMITTED TO THE SERVICING DRMO BY 25 JUN 87.

6. SHOULD THE DRMO HAVE ANY OF SUBJECT PESTICIDES IN INVENTORY, THE FOLLOWING INFORMATION SHOULD BE PROVIDED TO DRMR-MOH BEFORE 10 JUN 87: PRODUCT NAME, REGISTRATION NUMBER, LOCATION, UNIT SIZE, QUANTITY IN LBS OR BL, STOCK NUMBER, DTID NUMBER AND COST.

7. NEGATIVE REPLY IS REQUIRED.

8. POINT OF CONTACT IS GENE COGDILL, DRMR-MOH, (AV) 683-6690

BT

VR:DRMO CAMP LEJEUNE NC(4)...ACT

RTD:000-000/COPIES:0004

053389/154  
SN:VDTF00050

1 OF 1 MATA0580 154/23:39Z

031937Z JUN 87  
DRMR MEMPHIS T

*George - I have to  
reply by msg  
as soon as possible. Do  
we have any of this  
in our inventory?  
rh*

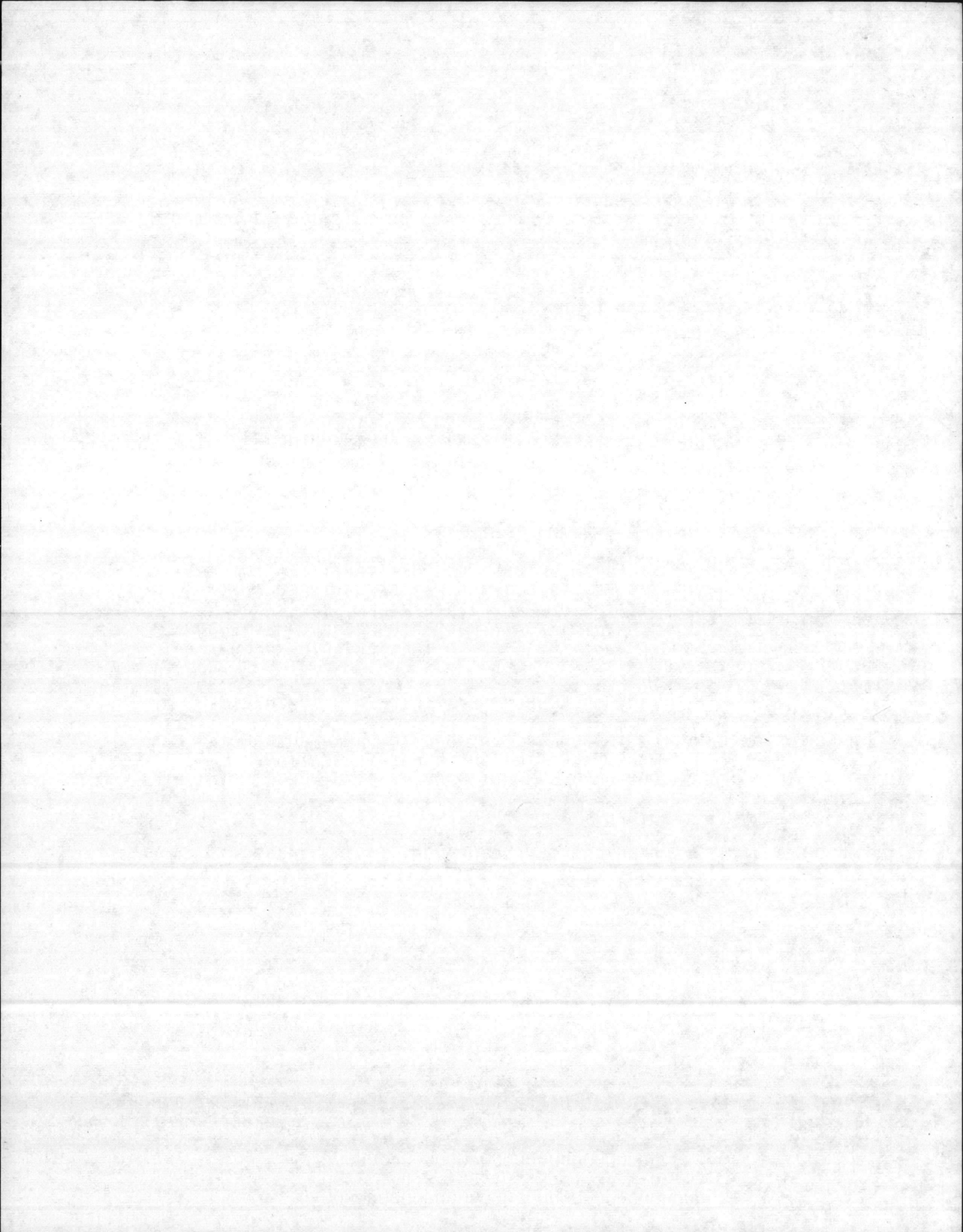







*Jimmy Kellum*

ATTACHMENT III

DIRECTIVES

The following is a listing of the more important laws, publications, regulations, and instructions. Those with an asterisk (\*) will be provided to the Contractor by the Government and shall be maintained by the Contractor in the Technical Library in accordance with Clause H.17.

1. Public Law 91-190, January 1970, "Environmental Protection"
2. Executive Order 11752, December 1973, "Prevention Control, Abatement of Environmental Pollution at Federal Facilities"
3. National Environmental Policy Act of 1969, January 1, 1970, 42 U.S.C. 4321, 4331-4335, 4341-4347
4. Marine Protection, Research and Sanctuaries Act of 1972, 33 U.S.C. 1401, 1402, 1411-1421, 1441-1444, as amended by P. L. 93-254, 22 March 1974
- ✓ 5. Occupational Safety and Health Act, December 29, 1970 P. L. 91-596, 84 Stat. 1590
6. Guidelines for Federal Agencies under the the National Environmental Policy Act, Issued by the Council on Environmental Quality, August 1, 1973
7. Code of Federal Regulations, Title 40, Protection of Environment, January 1, 1972
- Law Library 8. Federal Register, 39 F.R. 85, "Pesticides and Pesticide Containers -- Regulations for Acceptances and Recommended Procedures for Disposal and Storage"
- Law Library 9. Federal Register, 39 F.R. 200, "Pesticides -- EPS Proposal on Disposal and Storage"
- Law Library 10. Federal Register, 39 F.R. 174, "Federal Plant Pest Regulation; General; Plant Pest; Soil, Stone and Quarry Products; Garbage"
11. U. S. Department of Health, Education and Welfare and Environmental Protection Agency Publications, "Pesticide Protection"
12. U. S. Environmental Protection Agency Publication, "Public Health Pest Control"





DEPARTMENT OF DEFENSE  
ARMED FORCES PEST MANAGEMENT BOARD  
FOREST GLEN SECTION, WRAMC  
WASHINGTON, D.C. 20307-5001

Glenn: get up with Harold Gray,  
Insect Vector And find out what  
this means. Also Mr. Marlo Acock  
At HQMC can advise

D. Sharpe

AFPMB

2 April 1987

SUBJECT: Memorandum of Agreement Between the North Carolina Structural Pest Control Committee and the Department of Defense

SEE DISTRIBUTION

1. Subject memorandum (Encl 1) has been finalized. This is the twenty-sixth such agreement entered into since April 1986. Please note that this Agreement is with a second regulatory body in North Carolina. The NC Pesticide Board signed in August 1986. Authority for entering into these agreements lies in Executive Order 12088.

2. It is requested that all pest management professionals having responsibilities in North Carolina be advised of the existence of this document. It is also requested that separate agreements not be entered into with any states at the installation or service level without coordination with the AFPMB.

3. DoD pest management professionals working under the North Carolina/DoD MOAs, or subsequently signed agreements with other states, should attempt to resolve any issues that may arise at the local/state level. Issues that may set a precedent (payment of state licensing fees for DoD employees working on federal property, etc.) or that can not be agreed upon locally should be forwarded up the chain of command for resolution. When DoD involvement is required, contested issues should be presented by the Component involved to the Deputy Assistant Secretary of Defense (Environment) via the AFPMB.

FOR THE CHAIRMAN:

LARRY A. LEWIS  
CAPT, MSC, USN  
Executive Director

Encl

DISTRIBUTION:

LTC J. Young  
Mr. L. Stover  
Mr. D. Bandel  
COL B. Schiefer  
LTC J. Farlow  
LtCol N. Lamb  
Dr. A. Clark  
LtCol E. Goker  
LtCol D. Pinkovsky  
CDR T. Dickens  
CAPT J. Lamdin

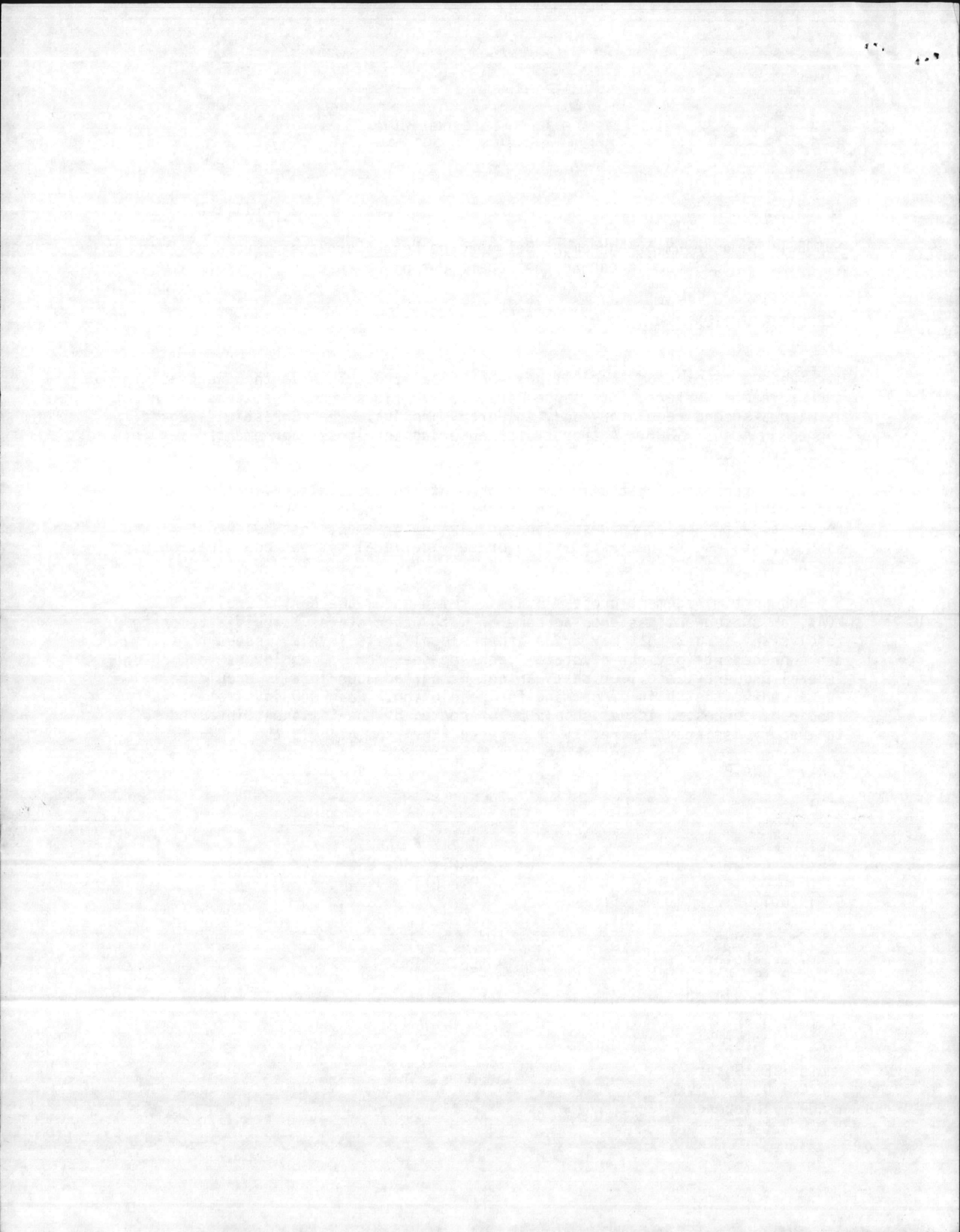

AFPMB

2 April 1987

SUBJECT: Memorandum of Agreement Between the North Carolina Structural Pest  
Control Committee and the Department of Defense

LTC B. McLaurin  
Mr. W. Gebhart  
Mr. M. Acock  
Mr. B. Bennett  
Dr. R. Bielarski  
LTC C. Johnson  
CDR D. Ehrhardt  
Mr. R. Jones  
Mr. B. Spencer  
Mr. M. Cornelius  
LtCol J. Lang  
Mr. M. Sandine  
Mr. E. Looney  
Dr. T. Biery  
LTC D. Kimbell  
Mr. J. Rosebush  
Maj T. Kasa  
LTC M. Sullivan  
COL M. Moussa  
Mr. R. Masse  
LTC A. Gillogly  
Mr. C. Smola  
Dr. D. Maiello  
Mr. S. Olsen  
Mr. J. Eversole  
CPT R. Jordan  
CPT W. Gordon  
Mr. W. Hunnicutt  
Mr. K. Harris  
Mr. T. Holmes  
Mr. W. Paschal  
Mr. D. Sewell  
Mr. D. Grimsley  
Mr. F. Kicklighter  
Mr. W. Armes  
1LT L. Smith  
Mr. R. Beam  
Mr. G. Leinbach  
Mr. P. Black  
Mr. J. Wooten  
Mr. C. Peterson  
Mr. D. Sharpe  
Mr. J. Mansfield  
Mr. D. Nelson  
Mr. W. Rogers  
Mr. J. Mease  
LT M. Lluberas

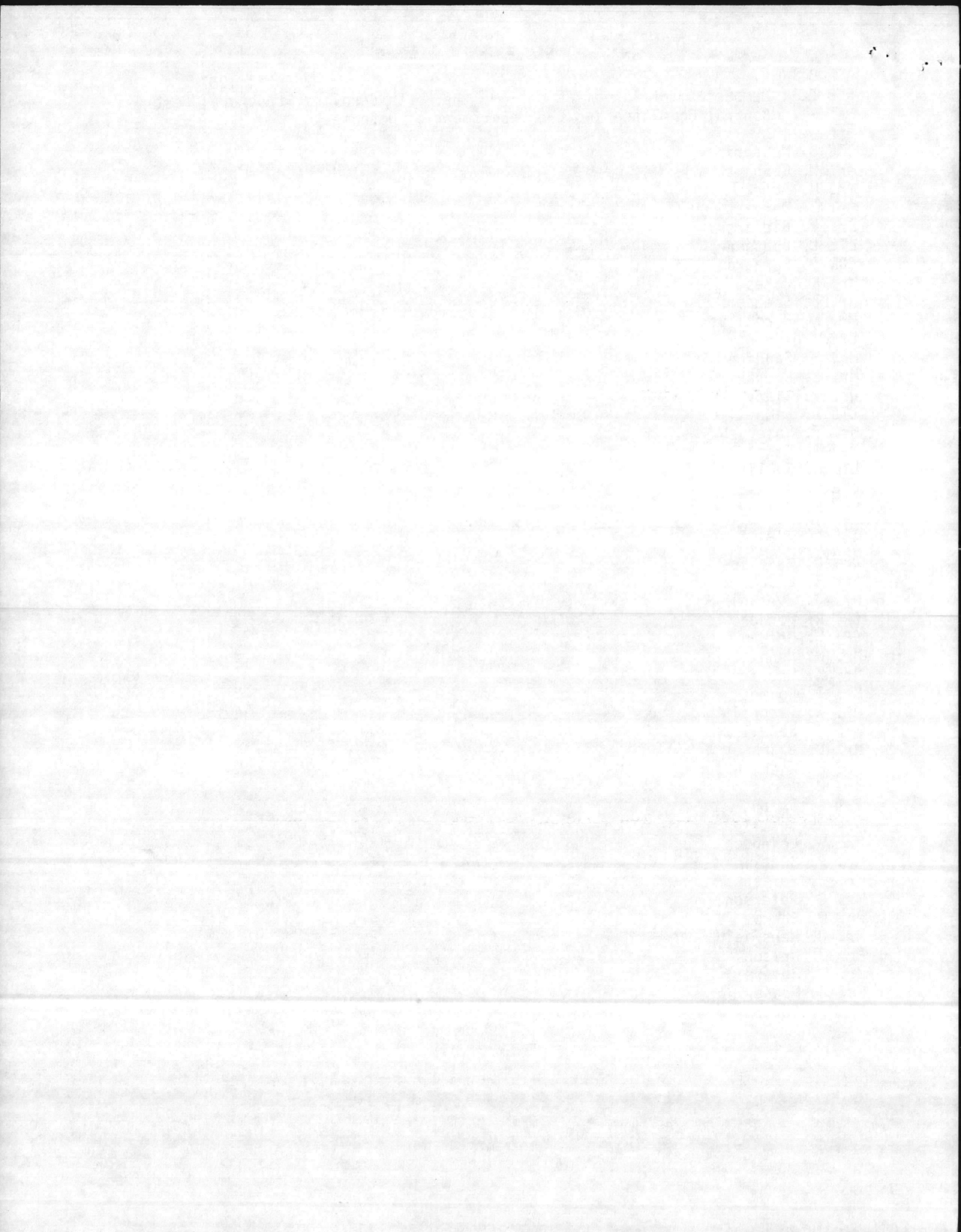



## State of North Carolina

Department of Justice

P.O. BOX 629

RALEIGH

27602-0629

March 31, 1987

LACY H. THORNBURG  
ATTORNEY GENERAL

Larry A. Lewis  
Capt., MSC, USN  
Executive Director  
Armed Forces Pest Management Board  
Forest Glen Section, WRAMC  
Washington, D. C. 20307-5001

RE: Memorandum of Agreement Between N. C. Structural  
Pest Control Committee and the U. S. Department  
of Defense

Dear Capt. Lewis:

Enclosed for your signature, date and seal are duplicate originals of the above referenced agreement. The two proposed changes pointed out in your February 25, 1987, letter to me (a new paragraph 3 and the addition of the word "significant" to paragraph 5) were approved by the N. C. Structural Pest Control Committee and therefore appear in these duplicate originals. There are no other changes.

After you have executed both documents, please keep one for your file and return one to me in the enclosed envelope. If you have any questions, please do not hesitate to contact me. I thank you for your courteous attention to this situation and I look forward to working with the Department of Defense pursuant to this agreement.

Sincerely,

LACY H. THORNBURG  
Attorney General

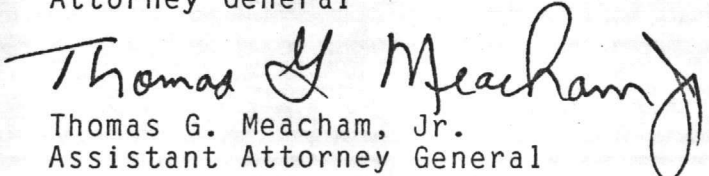
  
Thomas G. Meacham, Jr.  
Assistant Attorney General

LHT/TGM:ee  
cc: David McLeod

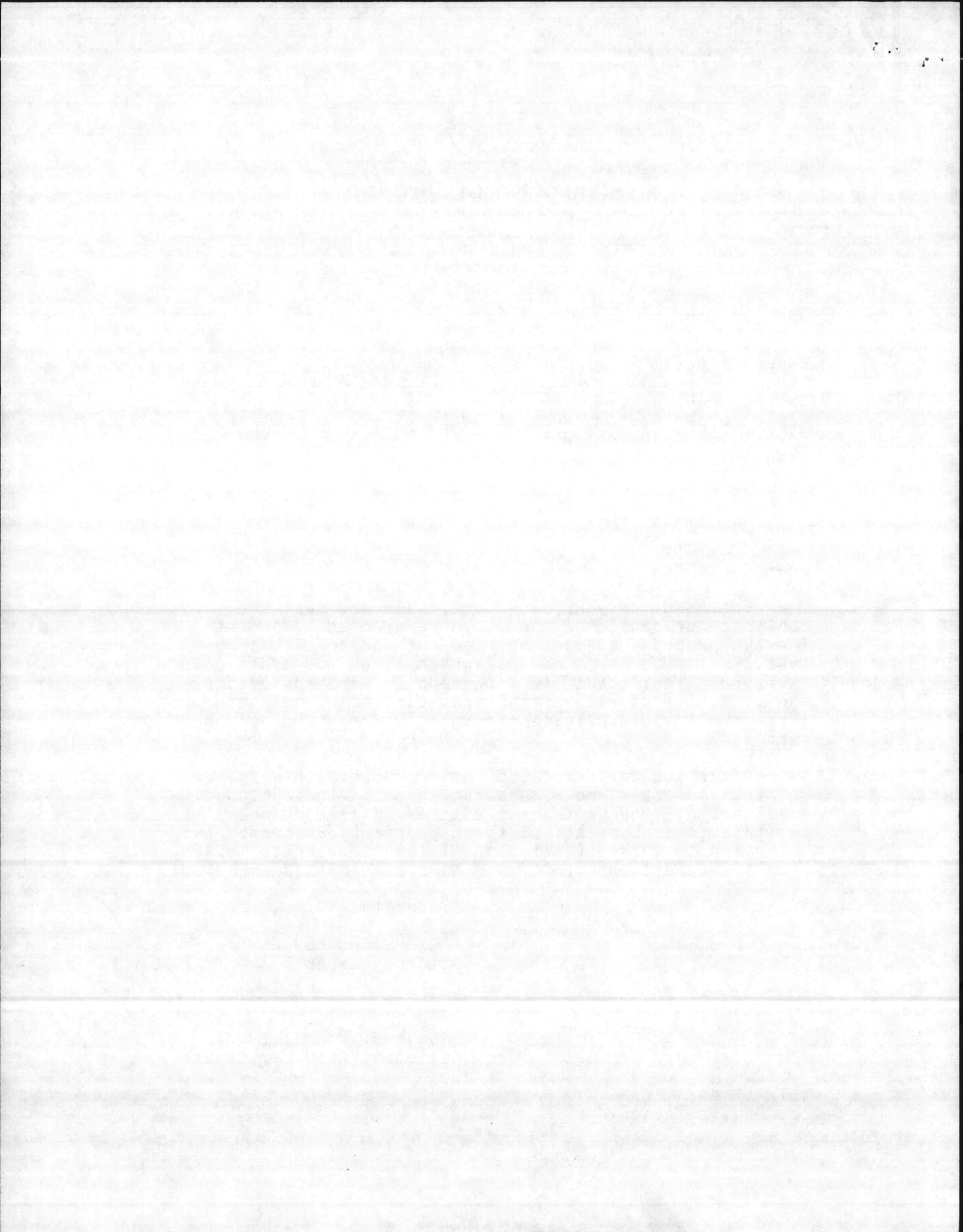



MEMORANDUM OF AGREEMENT BETWEEN THE NORTH CAROLINA  
STRUCTURAL PEST CONTROL COMMITTEE AND THE  
UNITED STATES DEPARTMENT OF DEFENSE

The purpose of this memorandum of agreement is to grant reciprocity under Article 4C, Chapter 106, of the North Carolina General Statutes to federal employees who have been certified as pesticide applicators by the U.S. Department of Defense (hereafter, DoD) and who are applying or supervising other federal employees in the application of pesticides on DoD premises in the State of North Carolina.

This memorandum of agreement is made pursuant to North Carolina General Statute 106-65.36.

IT IS AGREED THAT:

(1) Federal employees who are certified by DoD as pesticide applicators shall enjoy the same rights and privileges as a North Carolina certified applicator without the necessity of being certified in North Carolina. This includes, but is not limited to, the right to purchase and to apply pesticides, including restricted-use pesticides, on DoD premises for the control of structural pests. This also includes, but is not limited to, the right to supervise other federal employees in the application of these pesticides. This does not include the right to use or to supervise civilian personnel unlicensed by the State of North Carolina as pesticide applicators whether certified or not.

(2) The DoD agrees to recognize applicators certified under Article 4C, Chapter 106 of the North Carolina General Statutes as having fulfilled the requirements of DoD certification for the purpose of performing work on DoD premises.

(3) It is further agreed that the DoD shall submit to the North Carolina Structural Pest Control Committee on an annual basis the names of all DoD certified applicators located and operating in the State.

(4) The North Carolina Structural Pest Control Committee, or its authorized representative, may enter the DoD premises as mutually arranged:

- (a) to inspect any equipment used in the application of pesticides and to inspect the immediate premises on which that equipment is stored;



- (b) to inspect or sample land exposed or reported to be exposed to pesticides;
- (c) to inspect areas where pesticides are disposed of or stored; and,
- (d) to observe the use and application of pesticides.

(5) All information, records and documents relating to any significant pesticide violation confirmed by the North Carolina Structural Pest Control Committee, or its authorized representative, will be furnished to the U.S. Environmental Protection Agency for appropriate action under federal law.

(6) This agreement shall be effective upon the signature of the party last signing, may be changed at any time by mutual consent and will continue in effect unless terminated upon written notice by either party which shall be given 30 days prior to effective termination date.

Signed, this the 27<sup>th</sup> day of March, 1987.

*David S. McLeod*

NORTH CAROLINA STRUCTURAL PEST CONTROL COMMITTEE by David S. McLeod, Chairman

Signed, this the 2<sup>nd</sup> day of April, 1987.

*Larry A. Lewis*

FOR THE UNITED STATES DEPARTMENT OF DEFENSE by Larry A. Lewis, Capt., MSC, USN, Executive Director, *ARMED FORCES PEST MANAGEMENT BOARD*

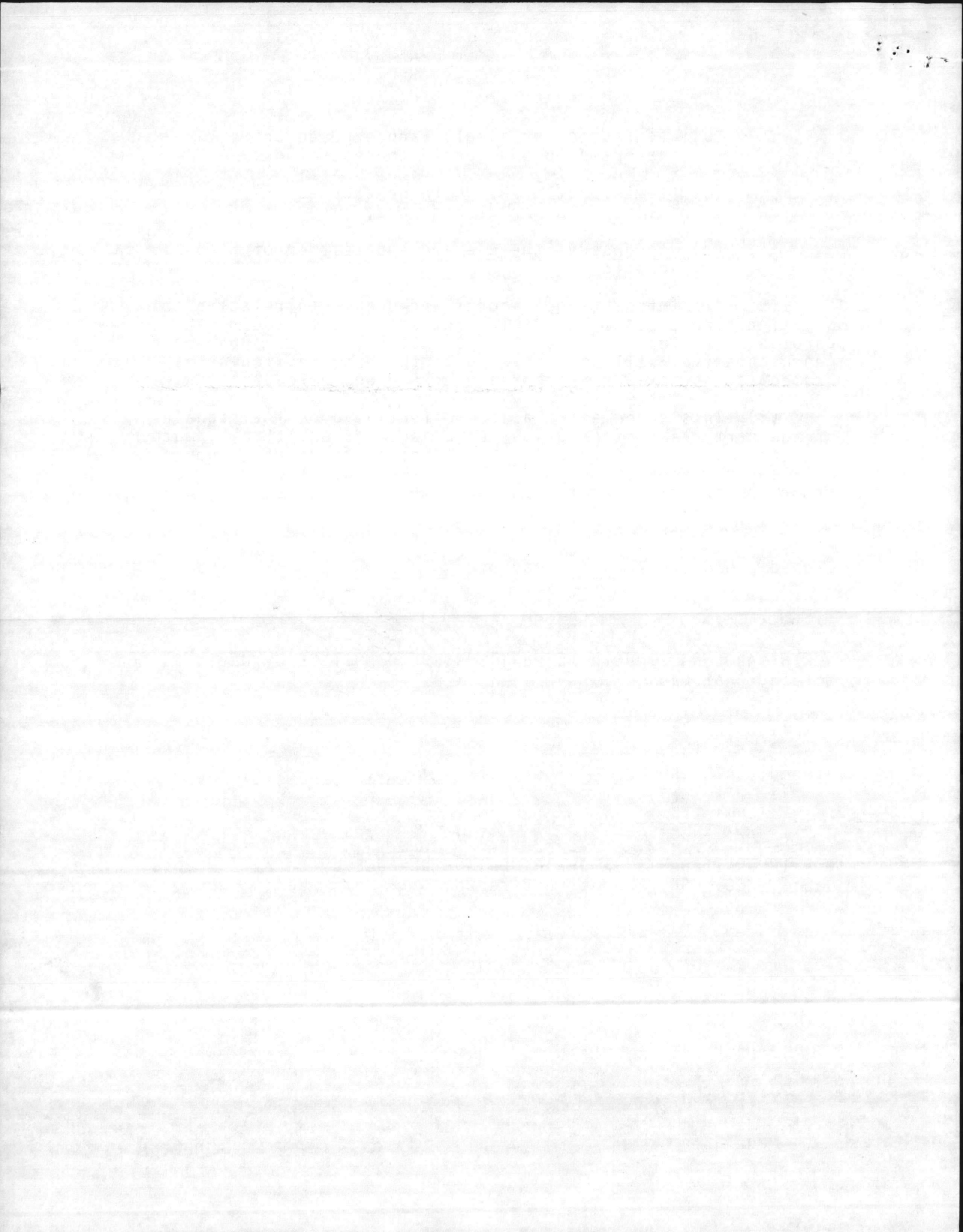

## Inter-Office Memorandum

*Danny D.  
for your info.  
24 NOV 1986 Pdine*

IN REPLY  
REFER TO

DRMR-MOH

SUBJECT: Ban of Herbicide

TO: Chiefs of DRMOs

1. Enclosures identify an EPA imposed immediate ban on the herbicide "Dinoseb" and its salts. DRMOs shall neither accept herbicides containing Dinoseb nor effect Reutilization, Transfer, Donation or Sale of existing stock, pending EPA indemnification and disposal instructions. Instructions are expected after cancellation hearings.
2. Only one NSN (6840-00-929-7950) has been identified for Dinoseb; however, enclosed is a list of Dinoseb Formulations. This product has not been ordered for several years and a check of this NSN on the IRIS was negative for turn-ins to DRMOs in the Memphis Region as of 28 Oct 86.
3. Point of contact at the Memphis Region is Terry Turley, (AV)683-6915.

2 Encl

*Fred Hamann*

FRED C. HAMANN  
Chief, Environmental Branch

Handwritten notes in the top left corner, including the number "10" and some illegible text.

Main body of handwritten notes, appearing as a list or series of entries, possibly related to a survey or field study.

Additional handwritten notes located in the lower right quadrant of the page.





DEPARTMENT OF DEFENSE  
ARMED FORCES PEST MANAGEMENT BOARD  
FOREST GLEN SECTION, WRAMC  
WASHINGTON, D.C. 20307-5001

AFPMB

10 October 1986

MEMORANDUM FOR DOD PEST MANAGEMENT PROFESSIONALS AND NATURAL RESOURCE MANAGERS

SUBJECT: EPA Emergency Suspension Order on Dinoseb

1. On 7 October 1986, EPA Administrator Lee M. Thomas ordered an emergency suspension order on the herbicide dinoseb [2-(sec-butyl)-4,6-dinitrophenol] and its salts. This is only the third time the EPA has issued such an order on a pesticide. Earlier orders were in 1979 for 2,4,5-T, and in 1983 for ethylene dibromide (EDB). An emergency suspension order means the material can not be sold, distributed or used, even if the user has stocks on hand. It is not known if similar constraints are planned on other dinitrophenol-based pesticides.
2. The order was made because field exposure to dinoseb poses "a very serious risk of birth defects to the unborn children of pregnant women, particularly if exposed during early stages of pregnancy". In addition, exposure poses a "significant risk of sterility to male farm workers". Recent studies have shown dinoseb to "cause neurological and skeletal defects in the offspring of laboratory animals, even at levels lower than those to which humans are exposed in the field". Dinoseb may also cause cataracts, cancer, and immune system damage. The herbicide has caused several deaths. However, allowable residues of dinoseb in food products appear to present no significant risks. People at greatest risk are those who mix, load, or apply the chemical, those entering treated fields, or those who are exposed to spray drift. Dinoseb is highly toxic and its labels generally include the signal word "Danger-Poison", but it is not listed as a restricted use pesticide by EPA. Dinoseb is listed as an acutely hazardous waste in CFR 261.33 (EPA Acute Hazardous Waste Number P020).
3. One formulation of dinoseb (also called DNBP) is in the supply system: NSN 6840-00-929-7950, Herbicide DNBP, Dow General Weed Killer, 30 gal drum, 55% active ingredient. The product has not been ordered for several years, and cancellation action has been initiated. Dinoseb normally is not used on DoD installations due to its toxicity and since it has limited non-cropland registrations for broadleaf weed control. However, a few installations evidently use the herbicide, having acquired it through local purchase. A list of the trade names of commercial products containing dinoseb is enclosed. Many of these are for agricultural use only, with exceptions as noted. This list was compiled from the U.S. Army Environmental Hygiene Agency's Pesticide Hotline and other sources. (The dinoseb situation is a good example of why the AFPMB is pursuing information on locally purchased pesticides in DoD.)

1 Enc

94

11



AFPMB

10 October 1984

SUBJECT: EPA Emergency Suspension Order on Dinoseb

4. If any of your installations possess dinoseb, all stocks should be retained in secure storage. Do not dispose of, distribute, or use the herbicide until further notice. Mr. Thomas E. Adamczyk, (EPA/OPTS-OPP-RD [TS-767]) was queried concerning the disposal and hazards of dinoseb. He said EPA will be forthcoming with a decision on handling, storage and disposal. However, no further action should be taken until this notice is received. The AFPMB will forward this information as soon as it is available.

FOR THE CHAIRMAN:

Encl

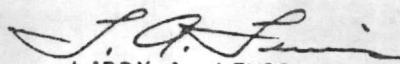
  
LARRY A. LEWIS  
CAPT, MSC, USN  
Executive Director

CF:

Mr. Schafer, DASD(E)

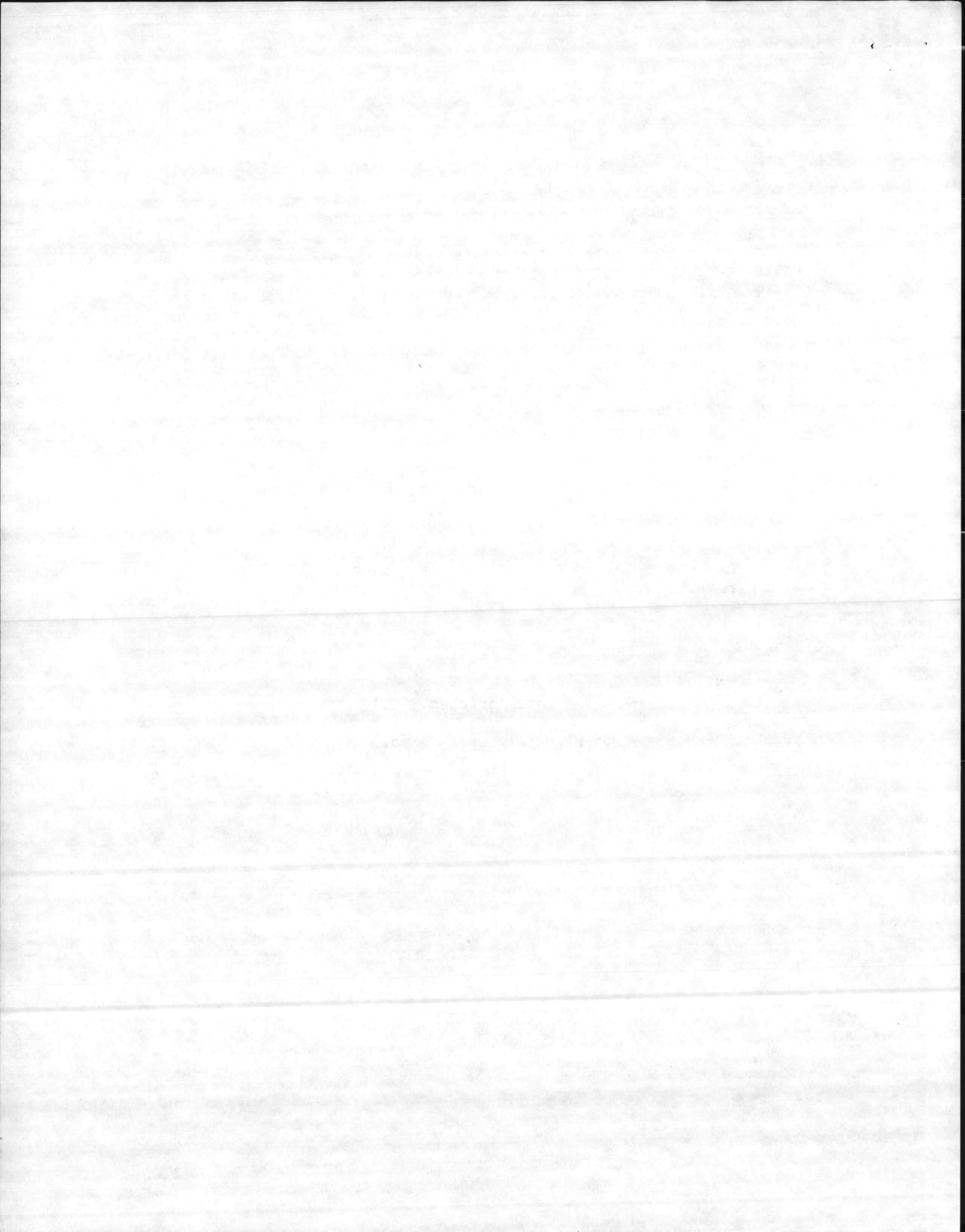

## HERBICIDES CONTAINING DINOSEB

### Dinoseb Formulations:

- Aretit (dinoseb acetate)
- Atlas Pure and Simple DNBP Amine
- Atlas Pure and Simple DNBP in Oil 25%
- Basanite
- \* Best Contact Weed Killer (See Oxy Contact Weed Killer)
- Caldon
- \* Chemox General (EPA Reg #44215-88, Kaw Valley, Inc.)
- Chemox PE
- Chemsect DNBP
- Cresocon
- Croptex DNBP
- DN-289
- \* Dinitro Weed Killer (EPA Reg #1526-494, Arizona Agrochem. Co.)
- \* Dinitro Weed Killer #5 (EPA Reg #400-174, Uniroyal)
- \* Dinitro 2.5 (EPA Reg #45115-28, Ida, Inc.)
- Dinitro 3
- \* Dinitro 5 (EPA Reg #45115-52, Ida, Inc.)
- \* Dinitro General Weed Killer (EPA Reg #829-197, South. Ag. Insect. Inc.)
- \* Dinoseb 5 (EPA Reg #400-140, Uniroyal)
- \* Dinoseb 3.3 (EPA Reg #400-158, Uniroyal)
- Dow DNOSPB
- \* Dynamyte 5 (EPA Reg #19713-29, Drexel Chem. Co.)
- \* Drexel Dynamyte 2.5 (EPA Reg #19713-78, Drexel Chem. Co.)
- Drexel Dynamyte 3
- Elgetol 318
- Farmon Desicoil 25
- Farmon DNBP Amine
- Gebutox
- Gilmore DNBP
- \* GWK (EPA Reg #1526-480, Arizona Agrichem. Co.)
- Haulmone
- \* Hel-Fire (EPA Reg #5905-217, Helena Chem. Co.)
- Herbon DNBP Amine
- Herbon DNBP in Oil 25%
- Hoe 002904 (dinoseb acetate)
- Ivosit (dinoseb acetate)
- Kiloseb
- Nitropone C
- \* Oxy Contact Weed Killer (EPA Reg #7001-77, J.R. Simplot Co.)
- \* Oxy Dinitro (EPA Reg #7001-327, J.R. Simplot Co.)
- Peabeeseh 20
- Phenotan (dinoseb acetate)
- Phytoxone
- Premerge

\*Products labeled for non-cropland uses.

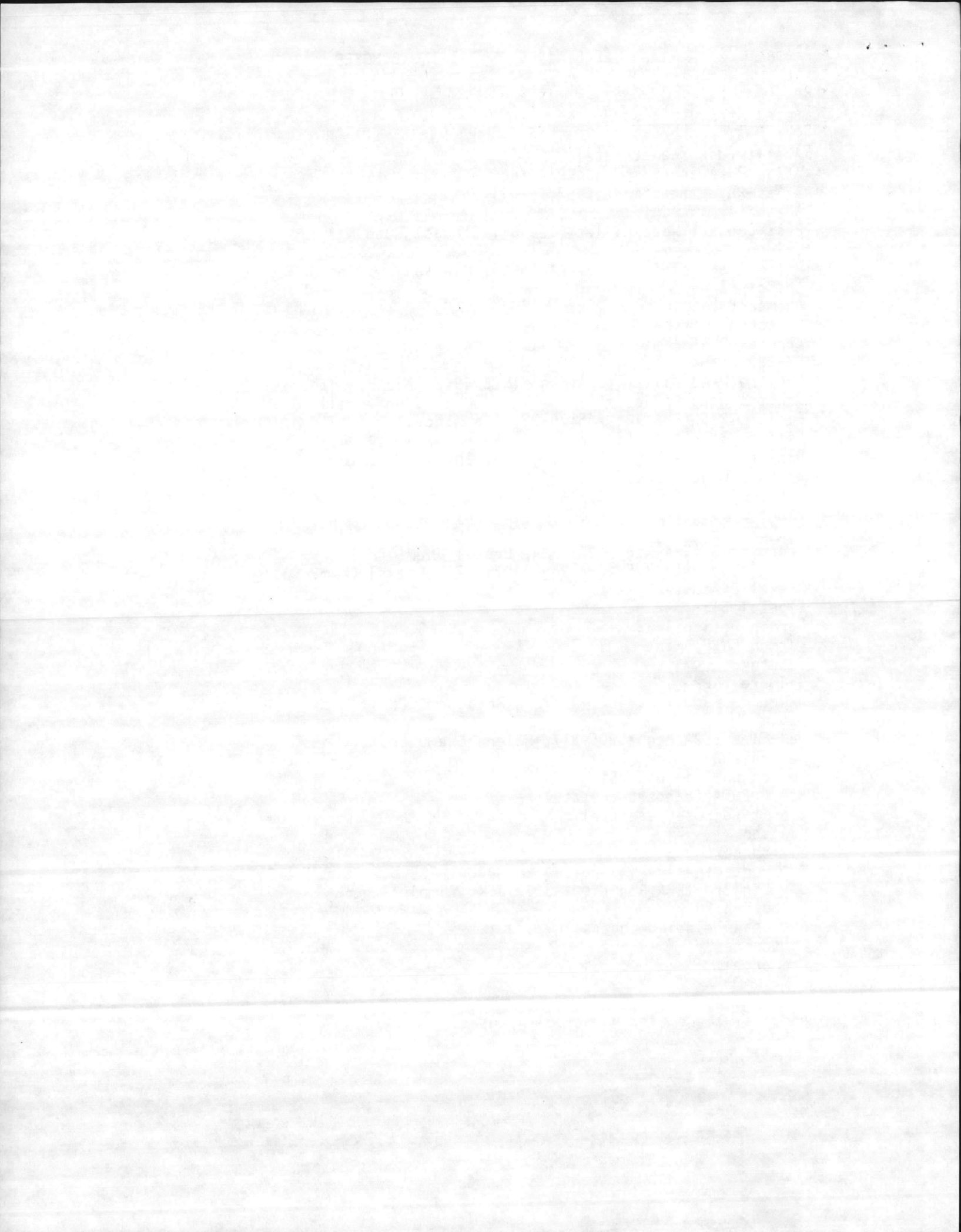

- \* Premerge 3
- \* Puregro General Weed Killer (EPA Reg #1202-205, Puregro Co)
- \* Red Top Contact Weedkiller (EPA Reg #2935-353, Wilbur Ellis Co.)
- \* Right-A-Way Weed Killer (EPA Reg #3797-4, DH Indus. Sup. Co.)
- \* Schall Contact Weedkiller (EPA Reg #3468-10, Schall Chem. Co.)
- \* Sim Chem Dinitro Weed Killer (EPA Reg #11682-11, J.R. Simplot Co.)
- \* Sim Chem Vine Killer (EPA Reg #11682-12, J.R. Simplot Co.)
- \* Sinox General (EPA Reg #279-1855, FMC/Niagara)
- \* Sinox Plus Code 31218 (EPA Reg #279-2836, FMC/Niagara)
- Subitex
- Superlovitox
- Supersevttox
- UniCrop DNBP
- Vertac Dinitro Weed Killer 5
- \* Vertac General Weed Killer
- Vertac Selective Weed Killer
- \* Western Farm Service Contact Weed Killer (EPA Reg #11656-1, WFS, Inc.)

Combination Formulations:

Ancrack (dinoseb and naptalam sodium salts)  
 Dyanap (DNBP + Alavap)  
 Klean-Krop (Dinitro + Premerge Plus)  
 Monolinuron + Dinoseb acetate  
 Premerge Plus (dinoseb + naptalam)

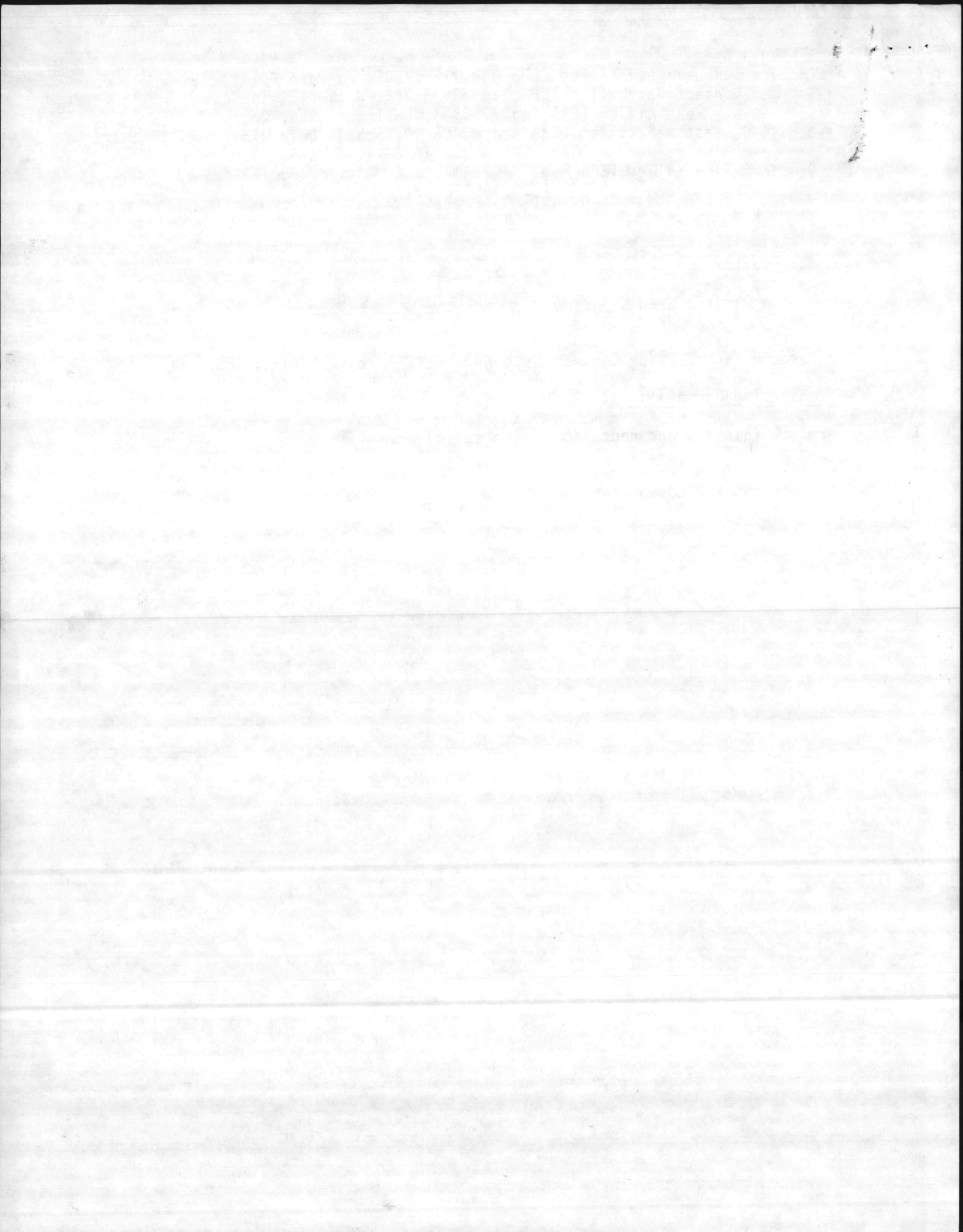



REPLY TO  
ATTENTION OF

DEPARTMENT OF DEFENSE  
DEFENSE PEST MANAGEMENT INFORMATION ANALYSIS CENTER  
ARMED FORCES PEST MANAGEMENT BOARD  
FOREST GLEN SECTION, WRAMC  
WASHINGTON, D. C. 20307-5001

*Glenoe. For info.  
Find out if the periodicals  
are available to us*

*Sharpe*

AFPMB/DPMIAC

15 June 1987

TO: All DoD Pest Management and Natural Resource Professionals  
From: Chief, Defense Pest Mgmt Info Analysis Center  
SUBJECT: Updates to the Directory of DoD Pest Management and Natural Resource Professionals

1. Enclosed is a list of additions and changes which we have received since the Directory was distributed in October.
2. Please keep us informed of any corrections and/or changes to your current address as printed in the Directory or on the attached list. Use page 002 of the Directory, the enclosed change of address form or contact Mrs. Mary Truitt of DPMIAC (Tel. (301) 427-5365 Autovon: 291-5365) to provide changes.
3. Also enclosed is a copy of the Index of Periodical Holdings in the Defense Pest Management Information Analysis Center.

Frederick J. Santana  
CDR, MSC, USN  
C, DPMIAC

3 Encl  
as





CORRECTIONS TO THE DIRECTORY

	<u>Page</u>	<u>Address</u>
1.	002	<u>Send Directory Changes To:</u> Defense Pest Mgmt Info Analysis Ctr AFPMB, Forest Glen Section, WRAMC Washington, DC 20307-5001
2.	004	<u>Abercrombie:</u> Change phone number to 486-7211/8357
3.		<u>Adams:</u> Add to name (Code 242B) Change phone number to 445-2369 & 565-2369
4.	005	<u>Armstrong:</u> Delete
5.		<u>Arnott:</u> Change Chief, ESB, USAEHA (HSHB-MS-P) Field Support Activity to Chief, ESB (HSHB-AM-P) USAEHA - Field Support Activity Change phone to (404) 752-2564/78 & 572-2564/78
6.	006	<u>Barton:</u> Change address to Route 1 - Box 104 1299 Z Avenue E. Athens, MI 49011 729-4554
7.		<u>Beavers:</u> Change address to NEPMU-5 Naval Station, Box 143 San Diego, CA 92136 (619) 696-6130 & 958-6130
8.	007	<u>Beisler:</u> Delete
9.	008	<u>Boardman:</u> Change address to C, Navigation & Flood Control Branch P.O. Box 898 Anchorage, AK 99606-0898
10.	009	<u>Braswell:</u> Change ATTN: to ATZH-DIC, USAC & FG FAC DIV DIS Zip code to 5060 4218/4148/2872
11.		<u>Brower:</u> Change LM to AG Harry Diamond Labs (SCLIS-FE-EM) 2800 Powder Mill Road Adelphi, MD 20783 (301) 394-2222 & 290-2222

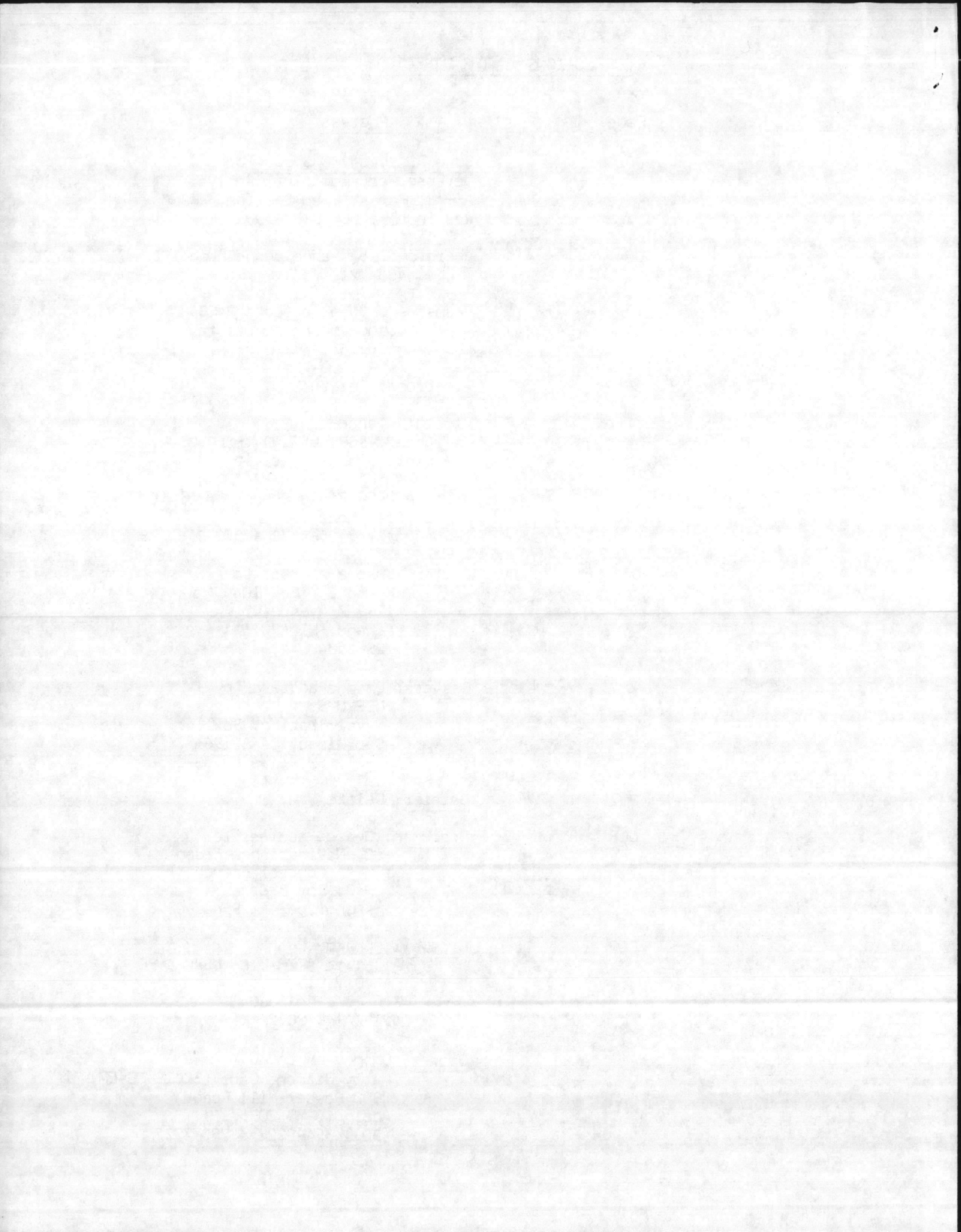

12. 010 Butler: Change ATTN: to  
SMCAR-ISE-OBL, Bldg 302-N  
Add to zip code 5001  
724-4653/4691 & 880-4653

13. Candler: Change address to  
10500 Forum Place  
Houston, TX 77036  
(713) 995-1112

14. Capuzzo: Delete

15. 012 Clark: Add ME  
Change Dr. to LCDR

16. Conroy: Delete

17. 013 Cox: Delete

18. 014 Currie: Change phone number to  
557-5017

19. 015 Divittorio: Delete

20. 016 Edgecomb: Change 2LT to CPT

21. Egan: Change phone number to  
752-2564 & 572-2564

22. Eiseman: Change AG to CE  
366 CSG/DEEV  
Mountain Home AFB, ID 83648  
(208) 828-2750 & 857-2750

23. 017 Endris: Add to zip code 0848

24. Fisher: Change phone number to  
(616) 961-5910  
Auto: 932-5910 & FTS: 552-5910

25. 018 Fordham: Change Wayne to Herbert W.  
HQ, USAF/LEEVN  
Bolling AFB  
Washington, DC 20332-5000

26. Frick: Change phone number to  
274-7541 & 284-7541

27. Fujii: Delete

28. Gale: Add to zip code 6288

29. Gale: Delete 24 from phone number

30. 020 Gottschalk: Change ATTN: to  
AETV-HNU-EB/Land Management  
320-8440

31. 022 Hassut: Change CPT to MAJ

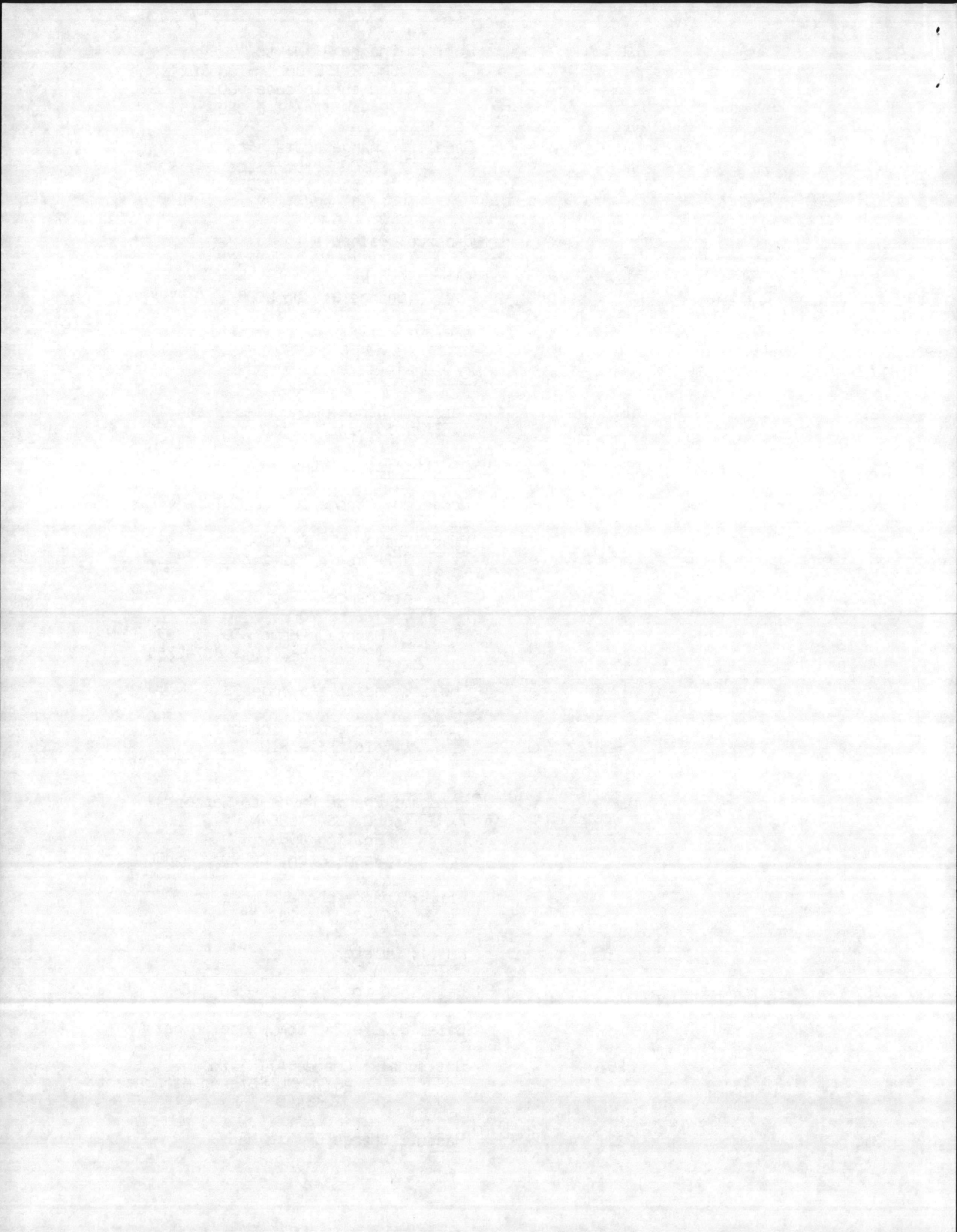

32. 023 Hensley: Change phone number to  
671-8101/08 & 584-8101

33. 023 Herbert: Change ATTN: to  
AFZF-DE-ENV  
Building 1938  
Zipe code to 5057  
287-2885 & 737-2885

34. Holmberg: Change Chief, Natural to  
Sacramento District Corps  
of Engineers  
Add to zip code 4794  
551-2112 & 460-2112

35. 023 Holness: Delete

36. 024 Hough: Change  
HQ, USAREUR - USA ISAE to  
ODCSENG-ROHRBACH

37. 025 Husted: Change ATTN to  
DPSC-HSTX (Alameda)

38. Johnson, CAPT Jerry M.: Change address  
Commandant (G-KOM-4)  
US Coast Guard  
Washington, DC 20590-0001

39. 026 Jones, Mr. Melvin J.: Delete

40. Kanour: Change address to  
Preventive Medicine Service  
Marine Corps Base  
1st Med Batt, 1st FSSG  
725-3203/4018 & 365-3203/4018

41. 027 Kasa: Change ATTN: to  
DPSC-HSTX  
Add to zip code 8419

42. 028 Knouf: Change Ken to Kenneth G.  
ATTN: STEJP-DEH

43. Konermann: Delete

44. Korch: Change address to  
PMPMD - USAEHA  
Aberdeen Proving Ground, MD 21010-5422  
(301) 671-3015/3792 & 584-3015/3792

45. Kverno: Delete

46. 029 Lamb: Change autovon 970 to 523

47. Lamdin: Change CDR to CAPT

48. Lang: Change HQ MAC/DEMU to  
HQ MAC/DEEV  
Autovon to 576-5764

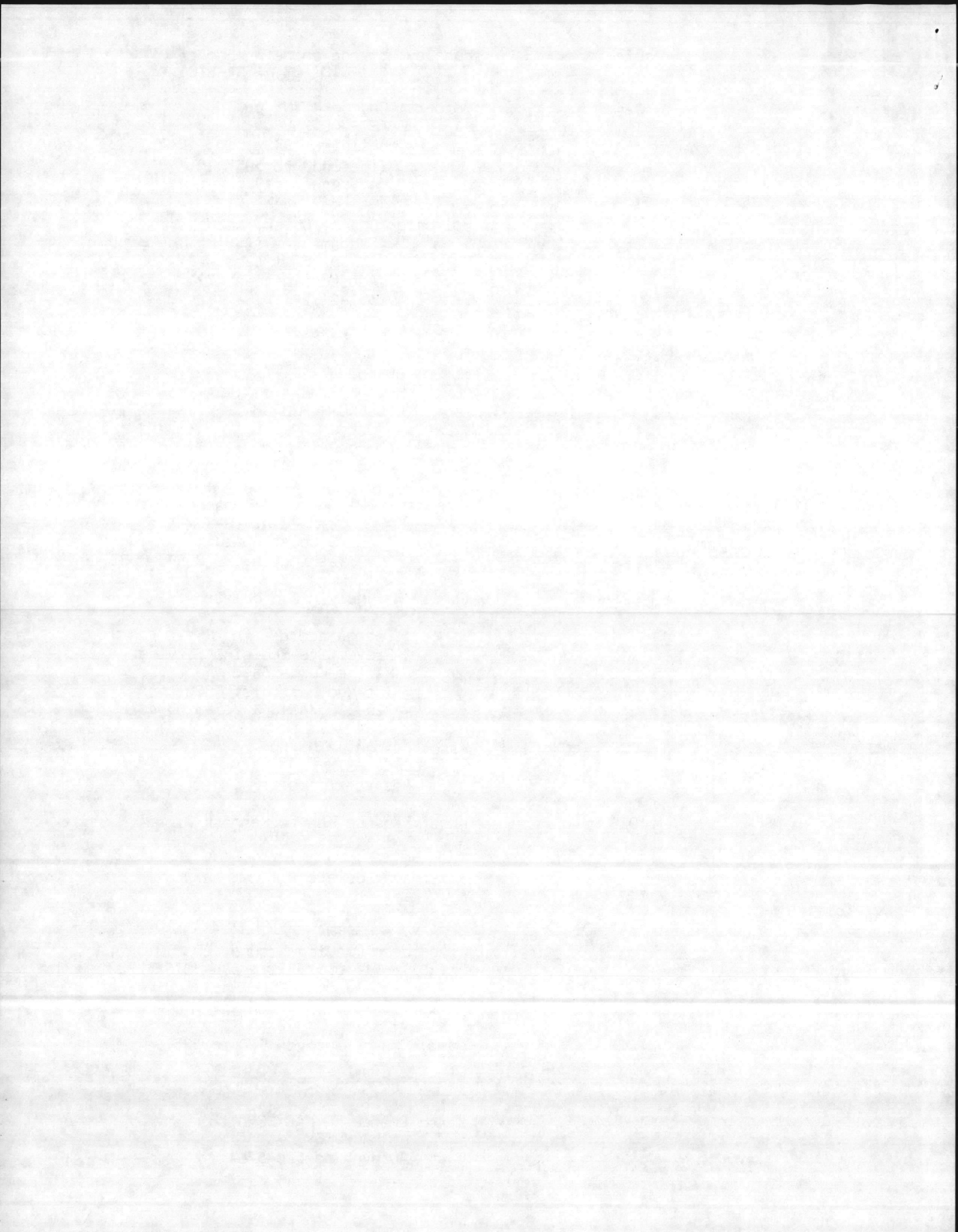

49. 031 Lombard: Delete

50. 032 Maiello: Change phone number to  
445-2931 & 565-2931

51. 033 Masse: Change phone number to  
981-4048/2464 & 858-4048/2464

52. McFarlane: Change phone number to  
961-5868  
Auto: 932-5868 FTS: 552-5868

53. 034 Mendez: Change address to  
US Army South  
USA Garrison, Panama  
ATTN: SOGA-EHB  
APO Miami 34004-5000  
285-4867/68

54. 035 Milberg: Change Ft. L. J. Mc Nair to  
Ft. Myer/B & G Branch  
Arlington, VA 22211-5050  
(202) 696-3815 & 226-3815

55. 036 Murdoch: Change zip code to 34011

56. 037 Noble: Change phone number to  
(616) 961-7412  
Auto: 932-7412 FTS: 552-7412

57. 038 Peter: Delete

58. 039 Phillips: Change address to  
C, Environmental Planning & Analysis  
Division  
AFFTC/DEV  
Edwards AFB, CA 93523-5000  
(805) 277-8092  
Autovon: 527-8092

59. Popella: Delete

60. 040 Powell: Change phone number to  
233-4105

61. Prather: Change address to  
OIC, Prev Med Svc (ATL)  
USAMEDDAC Panama - PSC Box 227  
APO Miami 34008  
89-4106/4701  
Autovon: 289-4106/4701

62. Pratt: Change MAJ to MAJ(P)

63. 41 Rambo: Add to name  
E. (Code 892)  
Add to zip code 5409

64. Rappaport: Change phone number to  
671-8101 & 584-8101

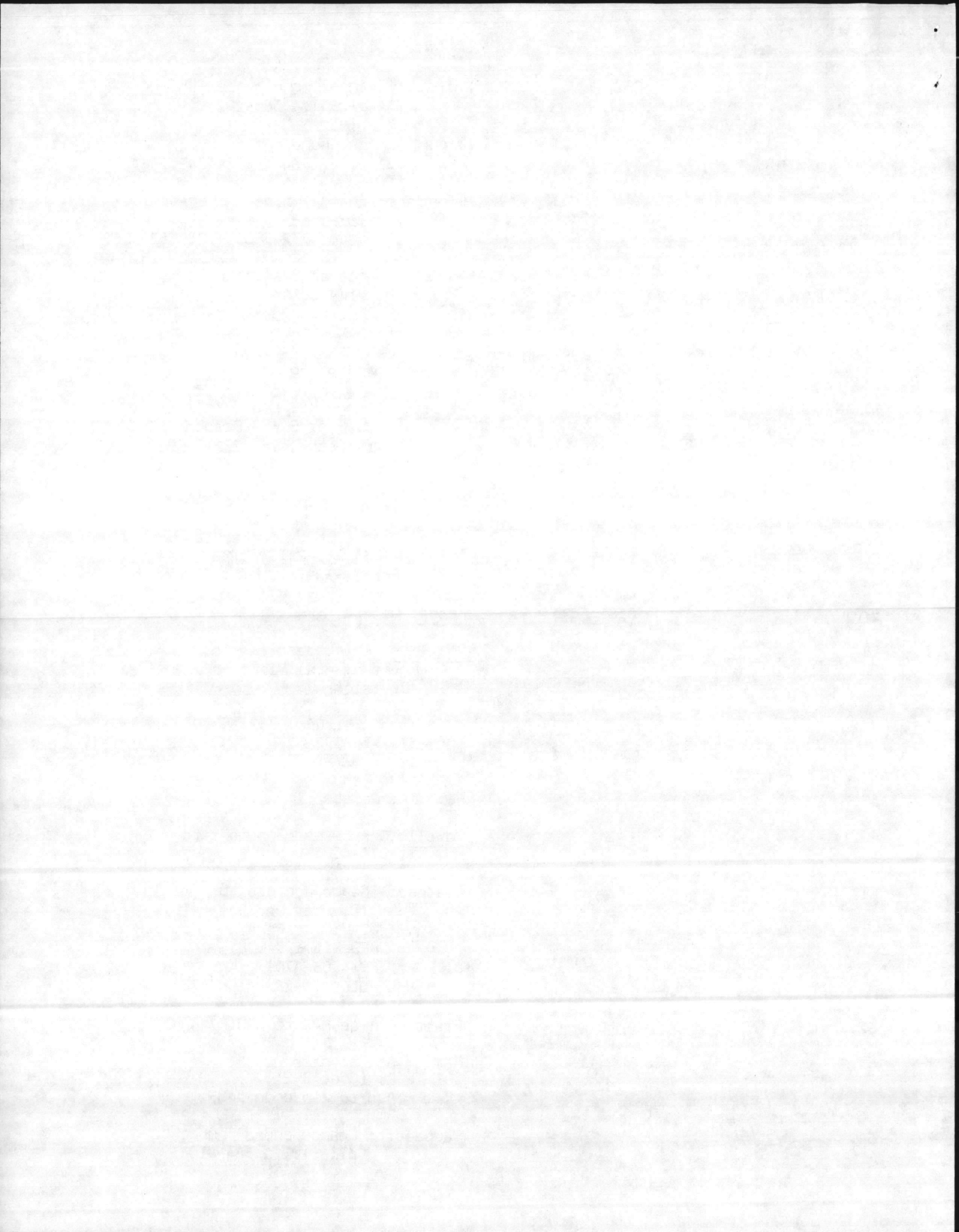



65. 042 Ruth: Delete

66. 043 Sandy: Delete

67. 045 Simmons: Delete

68. Smith 1Lt Lewis K.: Delete

69. Smith 1Lt Mike: Delete

70. 046 Solyan: Change phone number to  
961-5872  
Auto 932-5872 FTS: 552-5872

71. Spencer: Change phone number to  
727-2270 & 680-2270

72. Stanley: Change address to  
48th Support Battalion  
C Company  
Change zip code to 76546

73. 047 Stevenson: Change LT to LCDR

74. 048 Stroukoff: Change phone number to)  
724-2215 & 880-2215

75. Tarnopol: Change Fort Myers to  
Fort Myer

76. 049 Thomas: Delete

77. Trosper: Change address to  
DPMIAC/AFPMB  
Forest Glen Section, WRAMC  
Washington, DC 20307-5001  
(202) 427-5365/66  
Autovon: 291-5365

78. 050 Tschirhart: Delete

79. Turnbow: Change address to  
Directorate of Engineering &  
Housing  
Building 1404  
Fort Rucker, AL 36362-5137  
255-4901 & 558-4901

80. 051 Vorgetts: Change Mr. to Dr.

81. Wainwright: Delete

82. 052 White: Change address to  
ODCSENGR - ROHRBACH  
APO New York 09102-5347  
06221-57-9073/8125  
Autovon: 370-9073/8125

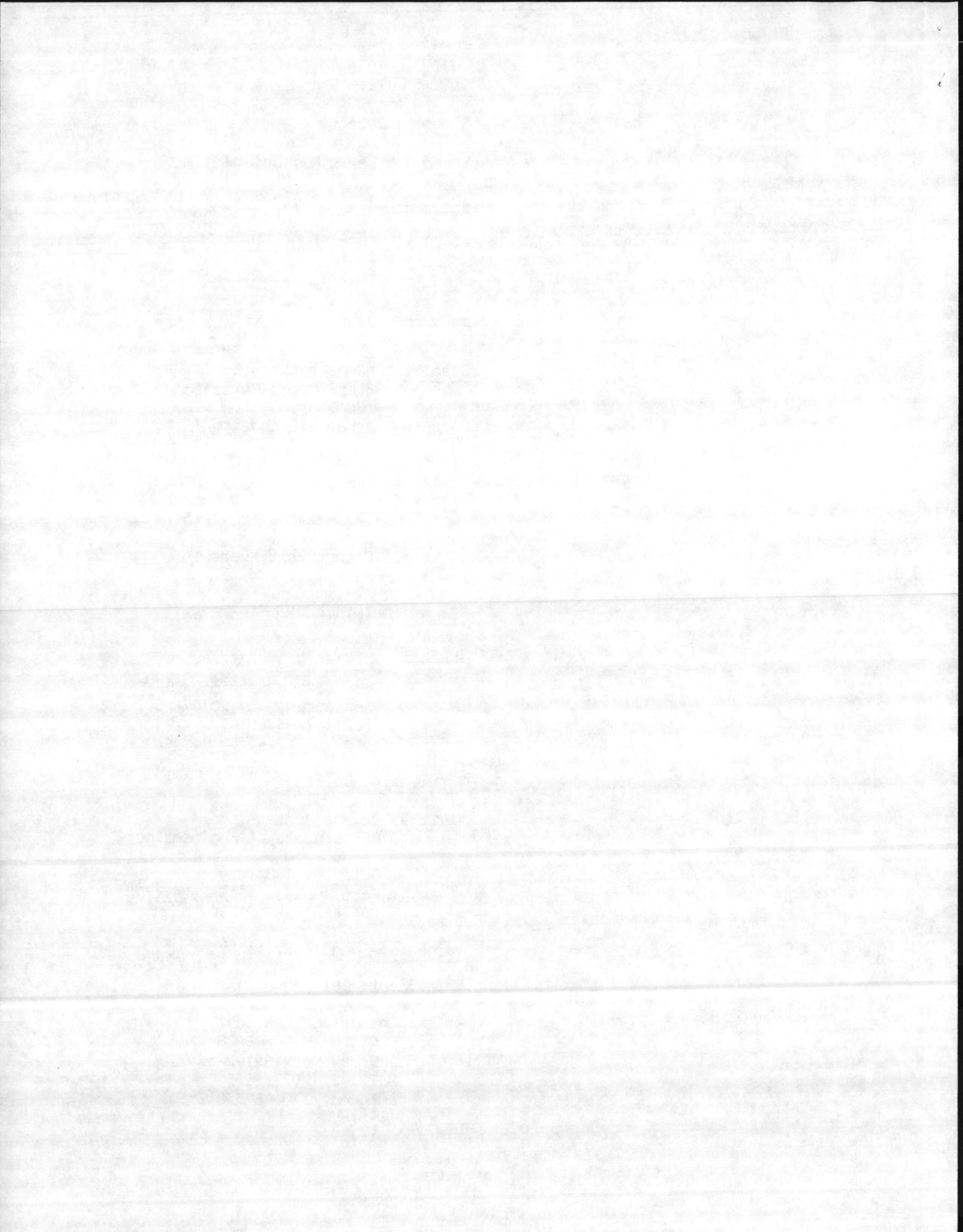

83. 052 Whitmer: Change address to  
342nd Medical Detachment (LA)  
5515 N.W. 15th Avenue  
Fort Lauderdale, FL 33309-2799  
(904) 772-9616
84. 053 Winters: Delete
85. 054 Wueste: Delete
86. Yamasaki: Change address to  
Paints & Chemical Commodity Ctr.  
9-FTE-10, GSA Center  
Change zip code to 98001
87. 055 Young, LTC Jimmy L.: Change address to  
Defense Logistics Agency - DLA-WS  
Cameron Station  
274-6357 & 284-6357

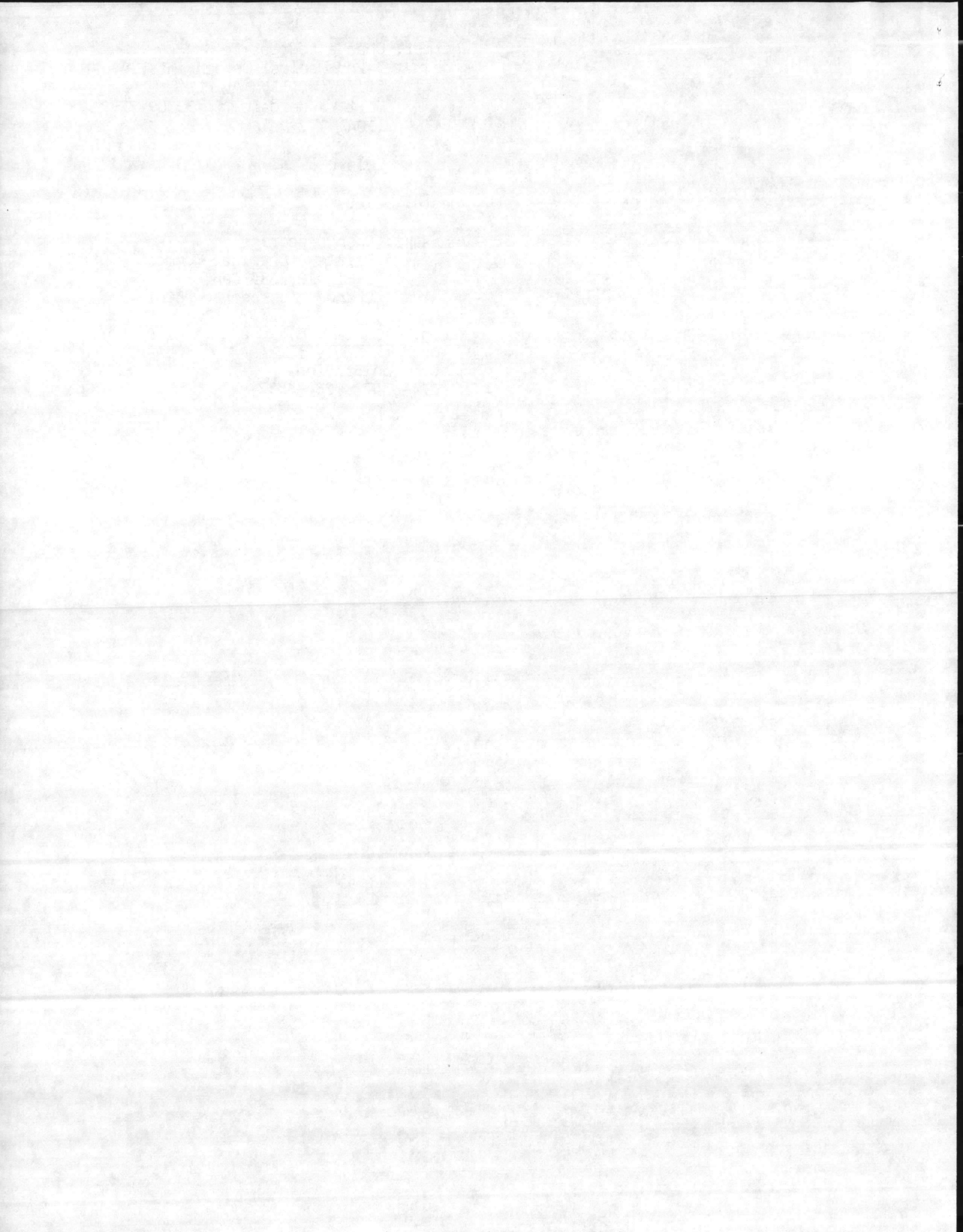

ADDITIONS TO THE DIRECTORY

AG Anderson, Mr. Robert S. (714) 383-3909  
63 CES/DEEV Autovon: 876-3909  
Building 409  
Norton AFB, CA 92409

WB Bryan, Mike (Code 892a) (301) 863-3670  
Environmental Protection Office, (PW) Autovon: 356-3670  
Naval Air Station  
Patuxent River, MD 20670-5409

GB Bunner, Ms. Bobbie L. (301) 663-7237  
USABRD - Building 568 Autovon: 343-7237  
Fort Detrick, MD 21701-5010

NR Chilton, Ms. Patricia (512) 479-2494  
67th CSG/DEEV Autovon: 685-2494  
Bergstrom AFB, TX 78743-5000

Garrett, LTC Joseph, VC, USA (214) 780-3604/04  
ATTN: Staff Veterinarian Autovon: 967-3604/05  
AAFES/QAV/P.O. Box 660202  
Dallas, TX 75266-0202

WB Hagan, William M. (805) 277-8092  
AFFTC/DEV Autovon: 527-8092  
Edwards AFB, CA 93523-5000

CE Jones, Mr. Ralph (817) 851-6559/2195  
3770 Technical Training Group Autovon: 736-6559/2195/2072  
TTGIC/43  
Sheppard AFB, TX 76311

GB Koenen, Mr. Brent A. (907) 353-6489  
AFVR-FW-DEEN Autovon: 353-6489  
Fort Wainwright, AK 99703-5500

AG Loesche, Ms. Annerose Germany  
CDR Hanau Milcom Autovon: 322-8440  
ATTN: AETV-HNU-BG/Land Management  
APO New York 09165

CE Main, Dr. Andrew J. Egypt  
Head, Medical Zoology Department Autovon: 820-727  
NAMRU-3  
FPO New York 09527

NR Manning, Capt Ed, USAF (919) 736-5513  
4 CSG/DEEV Autovon: 488-5513  
Seymour Johnson AFB, NC 27531-5005

CE McHugh, Dr. Chad P. (512) 536-3471  
USAFSAM/EKED Autovon: 240-3471  
Brooks AFB, TX 78235-5301

ME Milstrey, CPT Eric G. (301) 677-5281/6502  
ESD, USAEHA - FSA North Autovon: 923-5281/6502  
Field Support Activity  
Fort Meade, MD 20755-5225

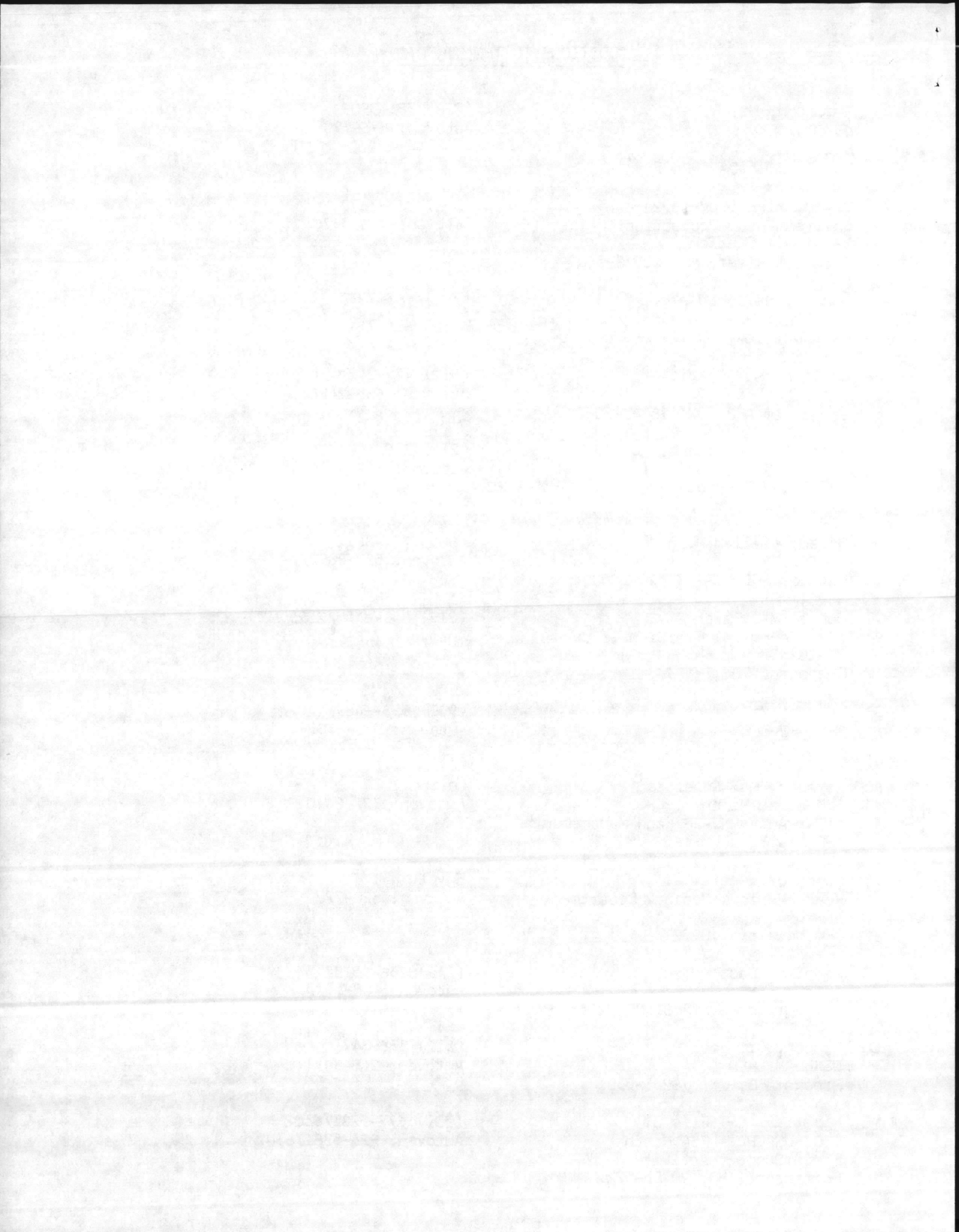

CE Perich, Dr. Michael J. (301) 663-7237  
USABRDL - Building 568  
Fort Detrick, MD 21701-5010  
Autovon: 343-7237

NR Potter, Laurin (301) 878-5878  
U.S. Garrison Fort Ritchie  
ATTN: ASNJ-DEH-EP&S  
Fort Ritchie, MD 21719-5010  
Autovon: 277-5878

Roberts, LTC Christopher A. M. (202) 797-3272  
Australian Army Staff/Embassy of Australia  
1601 Massachusetts Avenue, N.W.  
Washington, DC 20036

Rogers, Dr. John (202) 343-4088  
Chief, Division of Environmental Contaminants  
US Fish & Wildlife Services  
Washington, DC 20240

NR Rush, Mr. Christopher (805) 277-8092  
AFFTC/DEV  
Edwards AFB, CA 93523-5000  
Autovon: 527-8092

Taplin, Prof. David (305) 547-6214  
University of Miami/Department of Dermatology  
P.O. Box 016960 (R-122)  
Miami, FL 33101

Wade, Dr. Dale A. 436-8657  
ADC-APHIS-USDA  
6505 Belcrest Road, Room 565A-FB  
Hyattsville, MD 20782

CE Waligora, Mrs. Sharron (804) 878-2288  
ATTN: ATZF-FE  
Fort Eustis, VA 23604-5332  
Autovon: 927-2288

CE Walker, Mr. Gary L. (215) 952-3831  
DPSC - HSTX  
2800 South 20th Street  
Philadelphia, PA 19101  
Autovon: 444-3831

Welch, CW2 John M. (214) 780-3604/05  
ATTN: Staff Veterinarian  
AAFES/QAV/P.O. Box 660202  
Dallas, TX 75266-0202  
Autovon: 967-3604/05

WB Winchell, Mr. Clark S. (619) 725-3528/4512  
Marine Corps Base  
Natural Resources Office/Building 25154  
Camp Pendleton, CA 92055  
Autovon: 365-4512

Wood, Mr. John R. (301) 436-8657  
ADC-APJIS-USDA  
6505 Belcrest Road, Room 565A-FB  
Hyattsville, MD 20782

NR Wood, Mr. Robert W. (805) 277-8092  
AFFTC/DEV  
Edwards AFB, CA 93523-5000  
Autovon: 527-8092





INDEX OF PERIODICAL HOLDINGS IN THE  
DEFENSE PEST MANAGEMENT INFORMATION ANALYSIS CENTER  
 ARMED FORCES PEST MANAGEMENT BOARD  
 FOREST GLEN SECTION, WRAMC  
 WASHINGTON, DC 20307-5001  
 TEL: (202) 427-5365; AUTOVON: 291-5365

1965-82 (*) 1985-	Acarologia
1977-81 (*) 1985-	Acta Tropica
1985-	Administrative Management
1983-	Agrichemical Age
1983-	Agricultural Aviation
1983-	Agricultural Engineering
+ 1983-	Agricultural Research
1983	Agronomy Journal
1969-70 1971- (*)	American Journal of Epidemiology
1964-	American Journal of Tropical Medicine and Hygiene
1942-57 (*) 1958-	Annals Entomological Society of America
1965-	Annals Tropical Medicine and Parasitology
1956-	Annual Review of Entomology (Bookshelf)
+ 1984-86 (*)	Aquatics
1973-	Archives of Environmental Contamination & Toxicology
1987-	Bat Research News
** 1982 (*)	Biocontrol News and Information
+ ** 1964-67 (*) 1968-	Biological Abstracts
+ ** 1958-65 (*)	Boletin de la Oficina Sanitaria Panamericana

\* = Incomplete

+ = Journals received free of charge

\*\* = Includes Publications coded previously which we no longer receive

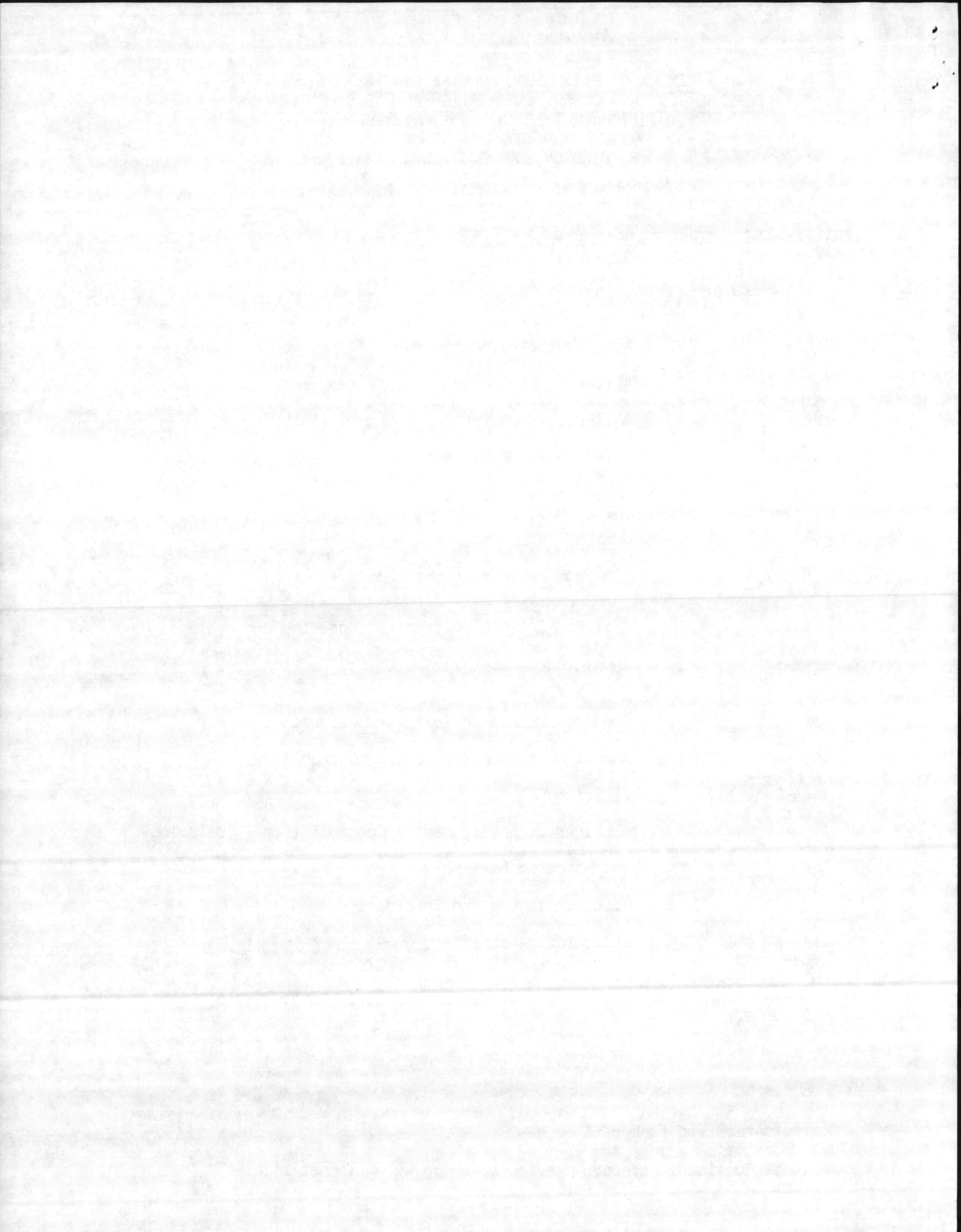

+ **	1975 1977-78	Boletin Informativo
+ **	1964 (*) 1965-77	Botyu-Kagaku (Publication discontinued)
**	1968-83 (*)  1960-61 1963-	ORSTOM (discarded after current SDI)  Bulletin Entomological Research
	1955-62 (*) 1963-	Bulletin Entomological Society of America
+	1969 1(2)- (*) 1970-  1967-	Bulletin Entomological Society of Canada  Bulletin Environmental Contamination & Toxicology
**	1973- (*)	Bulletin Missouri Academy of Sciences
+	1972- (*)  1965-  1974-	Bulletin Pan American Health Organization  Bulletin de la Societe de Pathologie Exotique  Bulletin of the Society of Vector Ecologists
	1963-82 (*) 1985-	Cahiers ORSTOM Serie Entomologie Medicale et Parasitologie
+	1979- (*)	California Agriculture
+ **	1956-79 (*)  1956-67 (*) 1969-	California Vector Views  Canadian Entomologist
**	1970-81	Canadian Journal Zoology
**	1983-84 (*)	Cast
+ **	1965-67 (*) 1968-69  1984-  1978-	CBE Factors Monthly Survey (Aerospace Technology Division)  Chemical Engineering News  Chemical Regulation Reporter
**	1965-81 (*)	Contributions of the American Entomological Institute
+ **	1958-75 (*)	Cooperative Economic Insect Report (only maintain coded issues)
**	1976-78 (*)	Cooperative Plant Pest Report (only maintain coded issues)
**	1983-86 (*)  1978- (*)	Crop Science  Current Contents

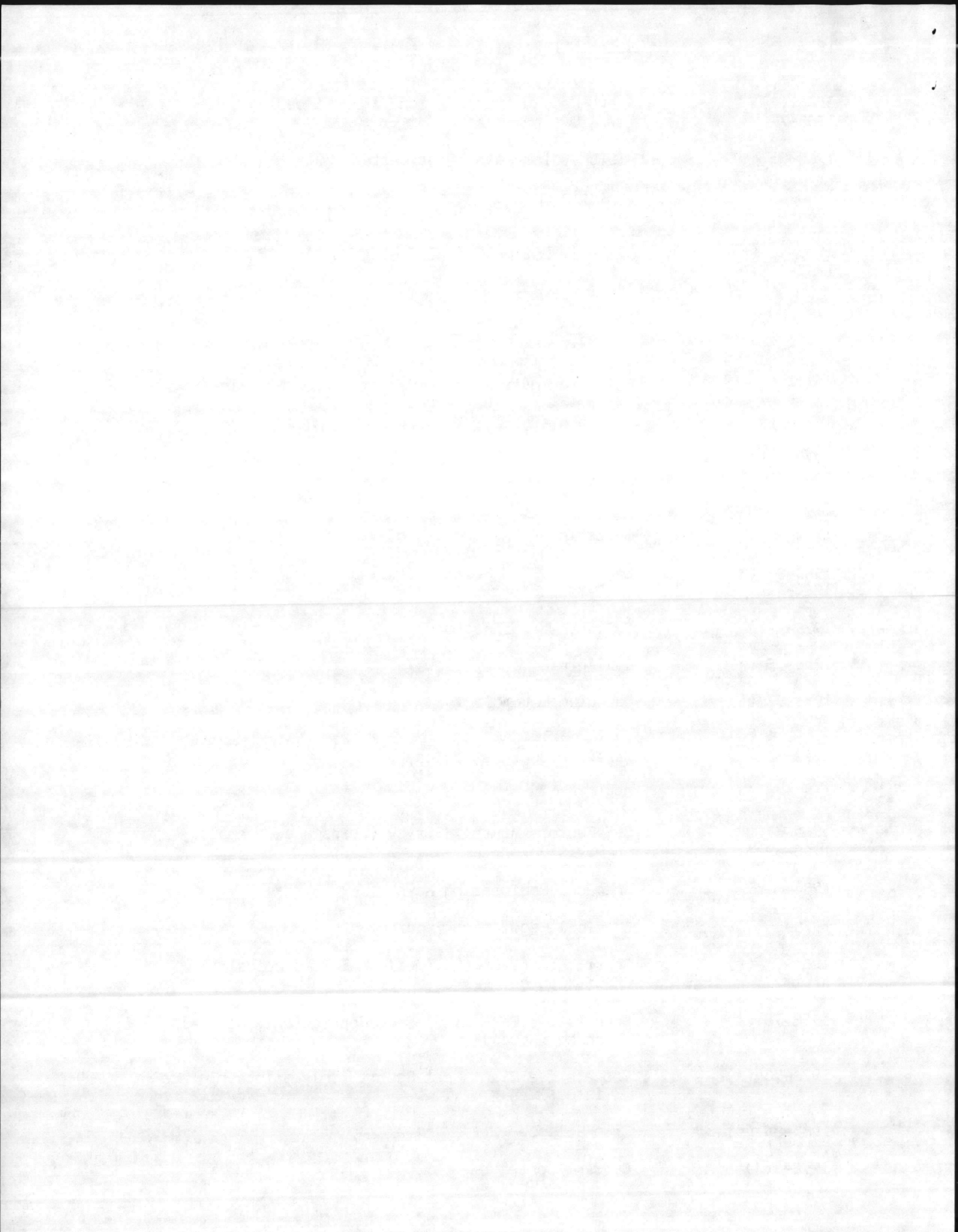

	1984-	Current Contents: Life Sciences
+	1963-	Danish Pest Infestation Laboratory Annual Report
+ **	1973-75	Dengue Newsletter for the Americas (WHO PAHO)
+ **	1975-80 (*)	Dengue Newsletter for Southeast Asia and Western Pacific Regions
+	1981-	Dengue Surveillance Summary
+	1981- (*)	Disaster Preparedness in the Americas
+ **	1968-74 (*)	Down to Earth (DOW Chemical Company)
+ **	1979-	Encephalitis Surveillance
	1979-	Endangered Species
+ **	1962-67	Endemic Disease Bulletin Nagasaki University
+	1987-(*)	Energy & Environmental News
	1969 (*)	Entomological News
	1970-	
	1958-59 (*)	Entomological Review (English translation
	1960-	Russian Entomol. Obozr.)
**	1978-85	Environment Reporter
+ **	1963-64 (*)	Environmental Effects of Materials and Equipment
	1972-	Environmental Entomology
+	1973-83 (*)	Environmental Health Perspectives (DHEW)
+	1978-	Epidemiological Surveillance (formerly Vigilancia Epidemiologia)
+	1985-	Epidemiology Bulletin (Republic of China)
**	1985	The Epidemiology Monitor
	1978-	Federal Register
+	1987-(*)	Fish and Wildlife Reference Service Newsletter
**	1969-81	Florida Entomologist
	1984-	Forest Science
+	1985- (*)	Global Disease Surveillance Report
**	1933-77 (*)	Gorgas Memorial Laboratory Annual Reports
	1979-	Government Reports, Announcement & Index (Discarded after it is reviewed for orders)
	1973-	Great Basin Naturalist

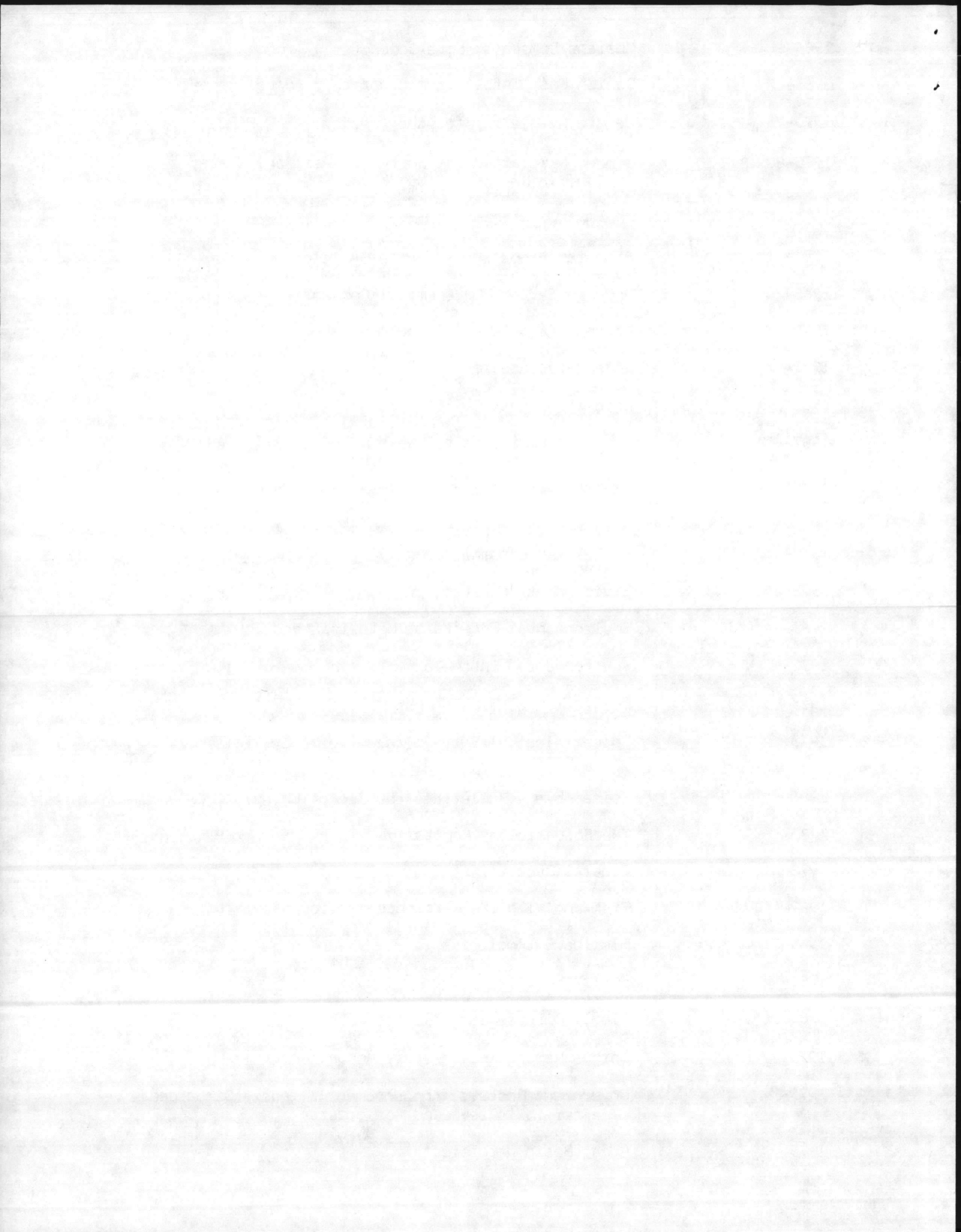

+ **	1966-67 (*) 1968-74	Health Aspects of Pesticides (DHEW - changed to Pesticide Abstracts)
**	1978-86 (*)	Hilgardia
**	1983-86	Hortscience
**	1973-75	Indian Journal of Entomology
+ **	1969-74 (*)	Industrial Vegetation Management (DOW Chemical Co.)
+ **	1975-78 (*)	Informative Bulletin
	1987-	Insect Science and Its Application
+ **	1967-69	International Epidemiologic Report (DHEW)
**	1985	International Journal of Entomology (Publication discontinued; formerly Pacific Insects)
**	1971-84 (*)	International Journal of Insect Morphology and Embryology
	1968-69 (*) 1970-	International Pest Control
	1981-	IPM Practitioner
	1975-	Israel Journal of Entomology
+	1964-	Japanese Journal Sanitary Zoology
	1984-	Journal of Agricultural Entomology
	1967 [15(6)] 1968-	Journal Agricultural and Food Chemistry
	1985-	Journal of the American Mosquito Control Association
**	1983-86	Journal of the American Society for Horticultural Science
+	1984-	Journal of Aquatic Plant Management
+ **	1976 [2(2)] 1977-85	Journal Association of Military Dermatologists
	1975-	Journal Australian Entomological Society
	1987-	Journal of Communicable Diseases
	1931-43 (*) 1944-	Journal of Economic Entomology
**	1971-75	Journal of Entomology Series A and B (formerly Proceedings Royal Entomological Society of London, Series A & B)
	1986-	Journal of Entomological Science (formerly Journal of Georgia Entomological Society)

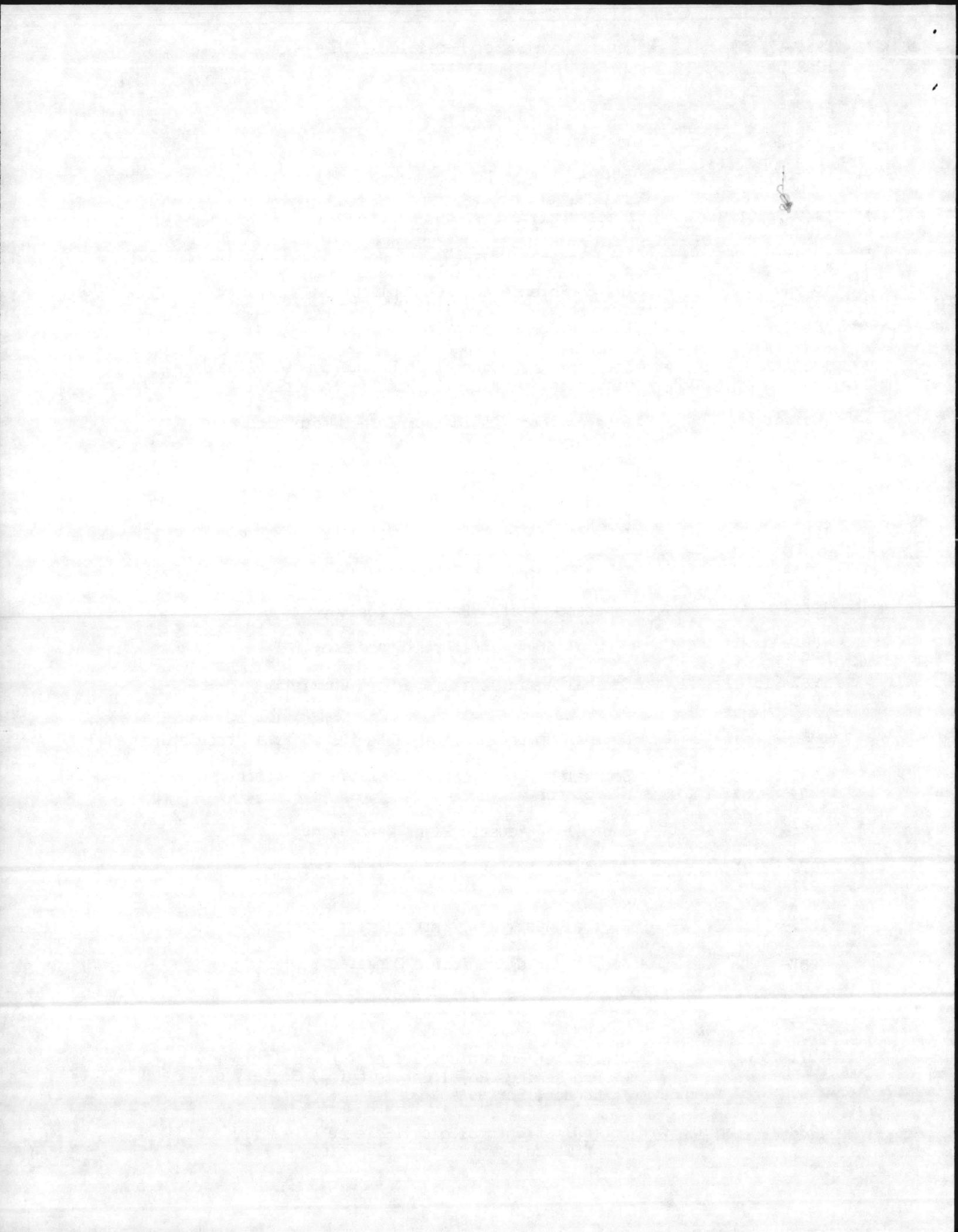



1985-	Journal of Environmental Quality
1983-	Journal of the Florida Anti-Mosquito Association
1984-	Journal of Forestry
** 1969-85	Journal of Georgia Entomological Society
** 1967-76	Journal of Insect Physiology
1967-	Journal of Invertebrate Pathology
1967-	Journal of Kansas Entomological Society
1964-	Journal of Medical Entomology
1967-	Journal of Parasitology
1983-	Journal of Range Management
1966-68 (*) 1969-	Journal of Stored Products Research
1966-	Journal of Tropical Medicine and Hygiene
1983-	Journal of Wildlife Management
+ 1987-	Kansas Pesticide Newsletter
** 1983 (*) 1984-86	Land Letter
+ ** 1963-73 (*)	Late News About Insects and Diseases
+ 1981- (*)	Medical Bulletin of the US Army
+ ** 1969-84 (*)	Melanderia
+ 1963- (*)	Memoirs Entomological Society of Canada
1980-	Military Medicine
1961- (*)	Morbidity and Mortality Weekly Report (DHEW) Complete 3 yrs. - prior uncoded issues discarded)
** 1973-82	Mosquito Annual Review
+ 1984-	Mosquito-Borne Diseases Bulletin
** 1944-46 (*) 1947-84	Mosquito News
1969-	Mosquito Systematics
+ 1987-(*)	NAL Agricultural Libraries Information Notes
+ ** 1960-81 (*)	National Clearinghouse for Poison Control Centers
+ ** 1960-85	National Pest Control Association Technical Release
+ ** 1969-81	National Pest Control Association Service Letters

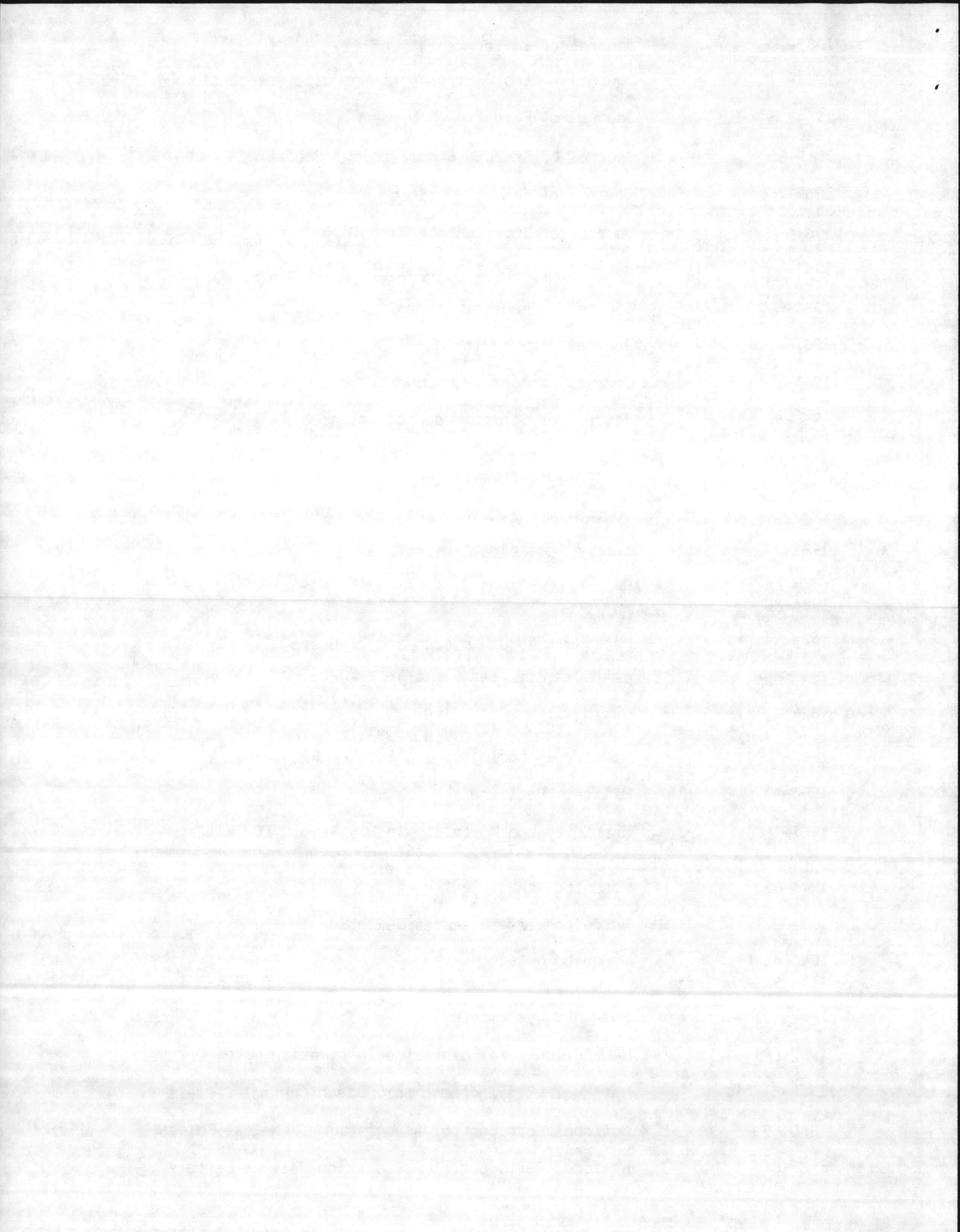

\*\* 1965-75 (\*) National Pest Control Operators News (Publication discontinued)

1986- National Wildlife

1986- New Jersey Vector Surveillance

\*\* 1986 New Scientist

+ 1976-80 (\*) Newsletter on Dengue, Yellow Fever and Aedes Aegypti in the Americas (WHO PAHO)

+ 1987- (8) Occupational & Environmental Health Notes

+ 1987- (\*) OCLC Newsletter

1987- On-line Data Accession

+ 1987- (\*) Outdoor News Bulletin

+ \*\* 1960-82 (\*) Pacific Insects (Publication discontinued; changed name to International Journal of Entomology)

+ 1980- Pan American Health Organization Epidemiological Bulletin

1982- Pan-Pacific Entomologist

\*\* 1967-75 Parasitology

1985- Parasitology Today

1984- (\*) Park Maintenance

1961- Pest Control

1980- Pest Control Technology

1981- Pest Management

+ \*\* 1974-81 Pesticide Abstracts (formerly Health Aspects of Pesticides)

1971- Pesticide Biochemistry and Physiology

1986- Pesticide and Toxic Chemical News

1987- Pesticide Science

\*\* 1957-62 (\*)  
1963-79 Pesticides Articles & News Summary (PANS)

+ 1987- (\*) Pesticides Coordinator Report

+ \*\* 1967-81 (\*) Pesticides Monitoring Journal

1976- Physiological Entomology (formerly Proceedings of Royal Entomological Society of London, Series A, 1965-70, which changed to Journal of Entomology, Series A, 1971-75)

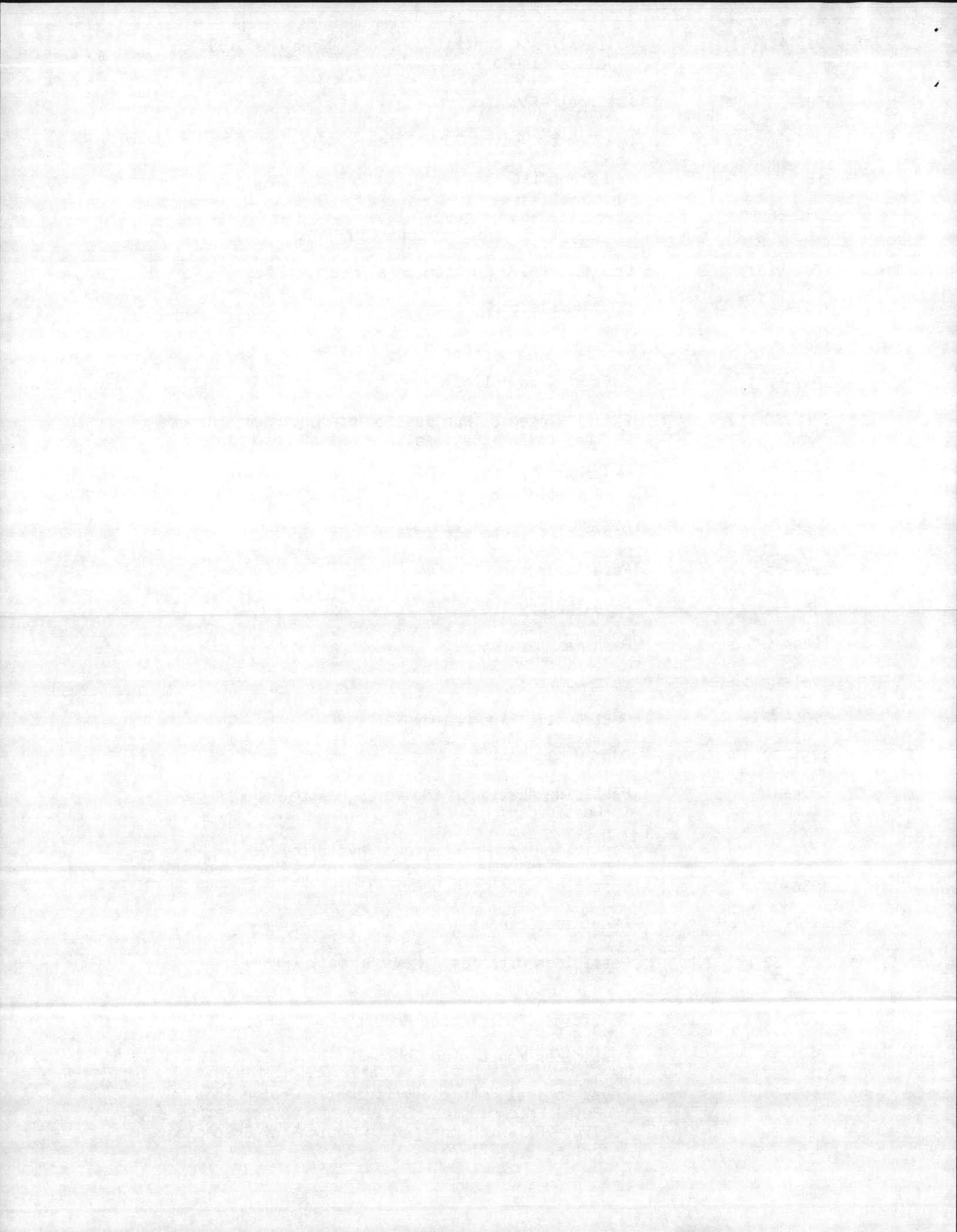

- \*\* 1970-76  
77(\*) Pollution Abstracts
- 1963- (\*) Proceedings Entomological Society Ontario
- 1946- Proceedings of the Entomological Society of  
Washington
- \*\* 1960  
1963-79 Proceedings of the Hawaiian Entomological Society
- 1944-60 (\*)  
1961- Proceedings of the New Jersey Mosquito Control  
Association
- + 1982- (\*) Proceedings of the Northeastern Weed Science Society
- 1948- Proceedings & Papers of the Annual Conference of the  
California Mosquito and Vector Control Assoc.
- \*\* 1965-66 (\*)  
1967-70 Proceedings of the Royal Entomological Society of  
London: Series A (changed to Journal of  
Entomology, Series A)
- \*\* 1967-70 (\*) Proceedings of the Royal Entomological Society of  
London: Series B (changed to Journal of  
Entomology, Series B)
- \*\* 1967-68 Vol 32 Proceedings of the Royal Entomological Society of  
London: Series C
- + 1987- (\*) Progress Newsletter
- \*\* 1969-78  
1980-81 (\*) Psyche
- + \*\* 1961-67 (\*) Public Health Engineering Abstracts (DHEW)  
(Publication discontinued)
- + 1963- Public Health Reports
- + 1957-60 (\*)  
1961-79  
1983 (\*)  
1985 (\*) Pyrethrum Post
- + 1984- Quarterly Bibliography of Major Tropical Diseases  
(WHO Publication in collaboration with DHHS)
- \*\* 1966-83 (\*) Residue Reviews
- \*\* 1958-65 (\*) Review of Applied Entomology Series A
- 1949-(\*) Review of Applied Entomology Series B
- + 1981- Schisto Update
- 1968- (\*) Science
- 1984- Science News
- + \*\* 1984-85 Science Trends

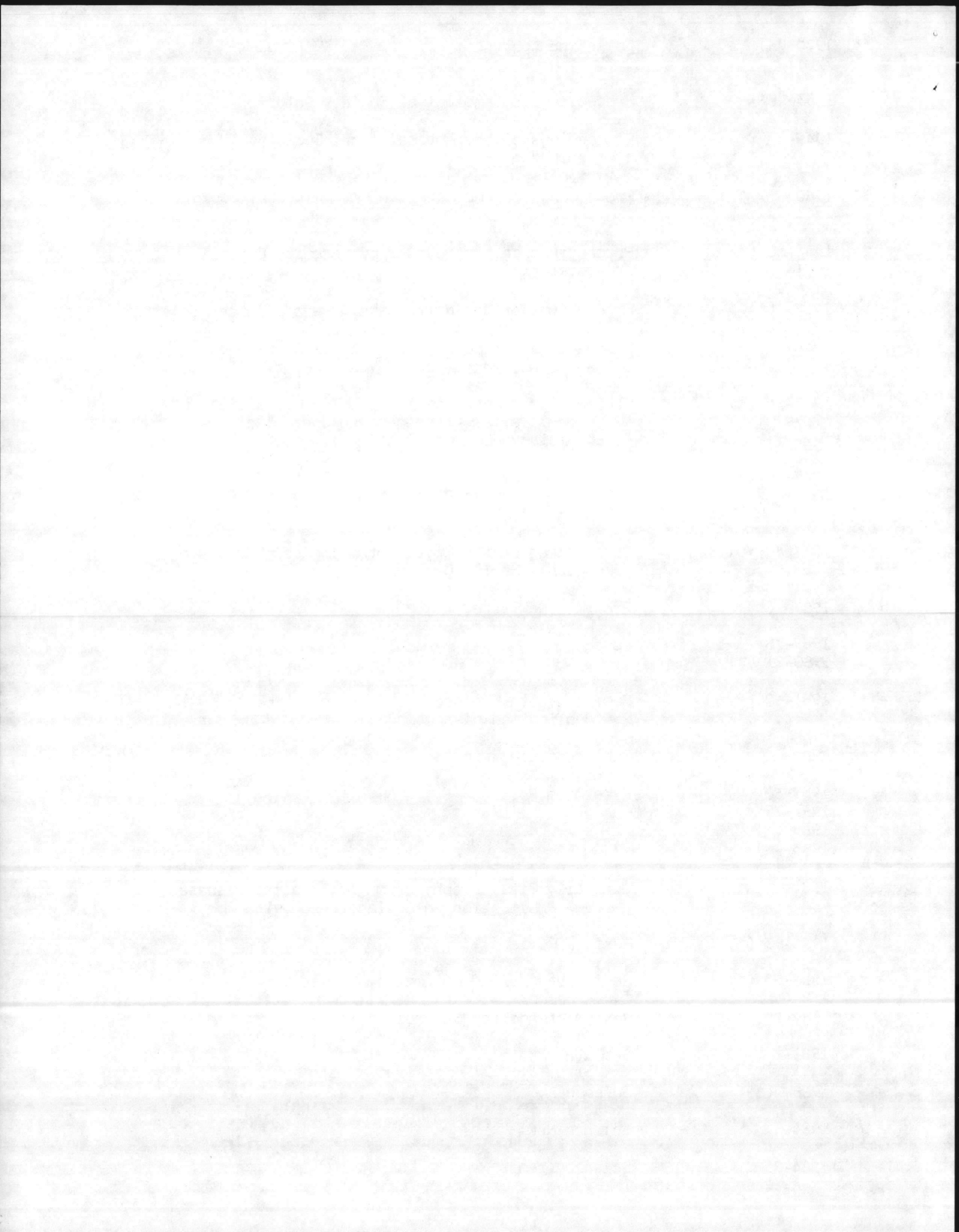

**	1985-86 (*)	Soil Science Society of American Journal
	1970-	Southeast Asian Journal of Tropical Medicine and Public Health
	1976-	Southwestern Entomologist
+ **	1953-55 (*) 1956-66	Summary of Investigations (DHEW)
	1976-	Systematic Entomology (formerly Proceedings of Royal Entomological Society of London, Series B, 1967-70, which changed to Journal of Entomology, Series B, 1971-75)
+	1964- (*)	Tin and Its Uses
	1968- (*)	Toxicology and Applied Pharmacology
	1978-	Toxicon
	1963-	Transactions of the Royal Society of Tropical Medicine and Hygiene
	1987-	Tropical Biomedicine
	1963-	Tropical Diseases Bulletin
**	1976	Tropical and Geographical Medicine
+	1967-	Tropical Medicine, Nagasaki University
+	1962- [11(2)] ** 1963-85 (*)	Tropical Medicine and Hygiene News
	1980-	Tropical Pest Management (formerly PANS)
+ **	1979-1986 (*)	Tsetse and Trypanosomiasis Information Quarterly
+	1963-70 (*)	US Army R and D News Magazine
+ **	1967-71 (*)	US Navy Medical Newsletter
+	1963-81 (*)	USDA Quarterly Reports - Entomological Research on Insects of Military Importance by Insects Affecting Man and Animals Research Laboratory
+ **	1982-83 (*)	USDA Semiannual Reports - Entomological Research on Insects of Military Importance by Insects Affecting Man and Animals Research Laboratory
+	1984- (*)	USDA Summary of Annual Research - Entomological Research by Insects Affecting Man and Animals Research Laboratory on Insects of Military Importance
+	1987- (*)	US National Committee for Man and the Biosphere - MAB Bulletin
+ **	1961-72	Vector Control Briefs (DHEW)

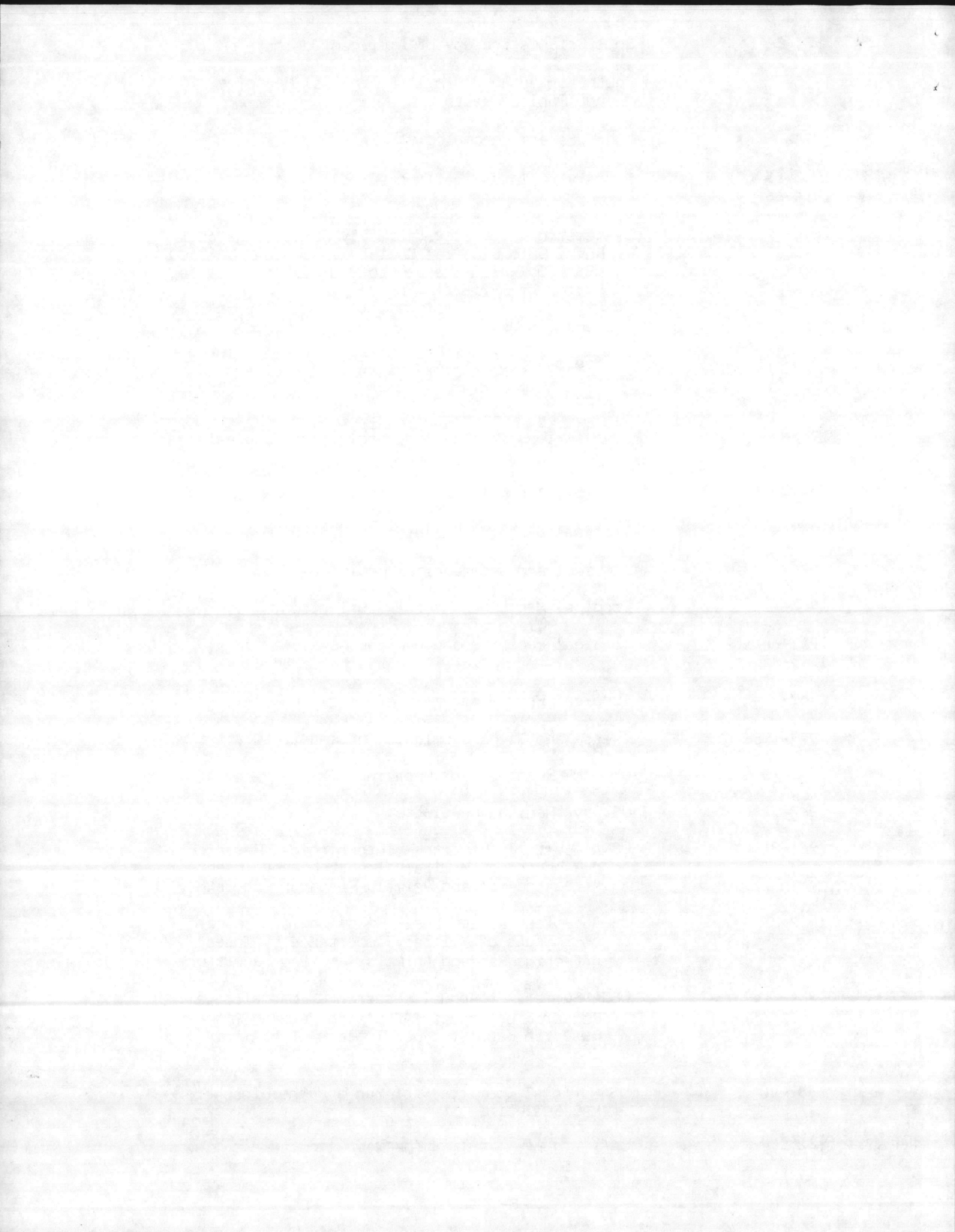



- + \*\* 1960-66 (\*) Velsicol Chemical Co. - Abstracts of Chlordane  
Endrin - Heptachlor Literature and News Releases
- + \*\* 1975-78 Vigilancia Epidemiologia (Changed to Epidemiological  
Surveillance)
- 1985- VS News
- \*\* 1983-85 Weeds Today
- 1984- Weeds, Trees and Turf
- + 1983- Wildlife Monographs
- 1983- Wildlife Society Bulletin
- + \*\* 1980-82 World of Agricultural Aviation
- 1960-66 (\*) WHO Bulletin  
1967-
- 1952- (\*) WHO Chronicle
- 1950- (\*) WHO Technical Report Series
- 1964- (\*) WHO Weekly Epidemiological Record (Complete  
3 yrs. - prior uncoded issues discarded)
- + \*\* 1963- (\*) WHO Weekly Epidemiological Report (Complete  
3 yrs. - prior uncoded issues discarded)
- \*\* 1965-82 (\*) WHO World Health Statistics Quarterly (Complete  
3 yrs. - prior uncoded issues discarded)
- \*\* 1981 World Health Forum
- 1987- World Status Map (Current State Department Traveler  
Advisories, Warnings, and Wire Reports)

Additional Irregular (unpublished documents) WHO Publications:

- + \*\* 1962 [1] WHO/EBL  
1963-66 (\*)
- + 1966-77 (\*) WHO/FIL  
1979-(\*)
- + \*\* 1968-76 (\*) WHO/IRG
- + \*\* 1956-68 (\*) WHO Information Circulars (Insecticide Resistance,  
Insect Behavior, Vector Genetics, Toxicity of  
Pesticides to Man, and Vector Control)
- + \*\* 1958-62 (\*) WHO Insecticides
- + \*\* 1967-79 (\*) WHO/LEISH
- + 1961- (\*) WHO/MAL

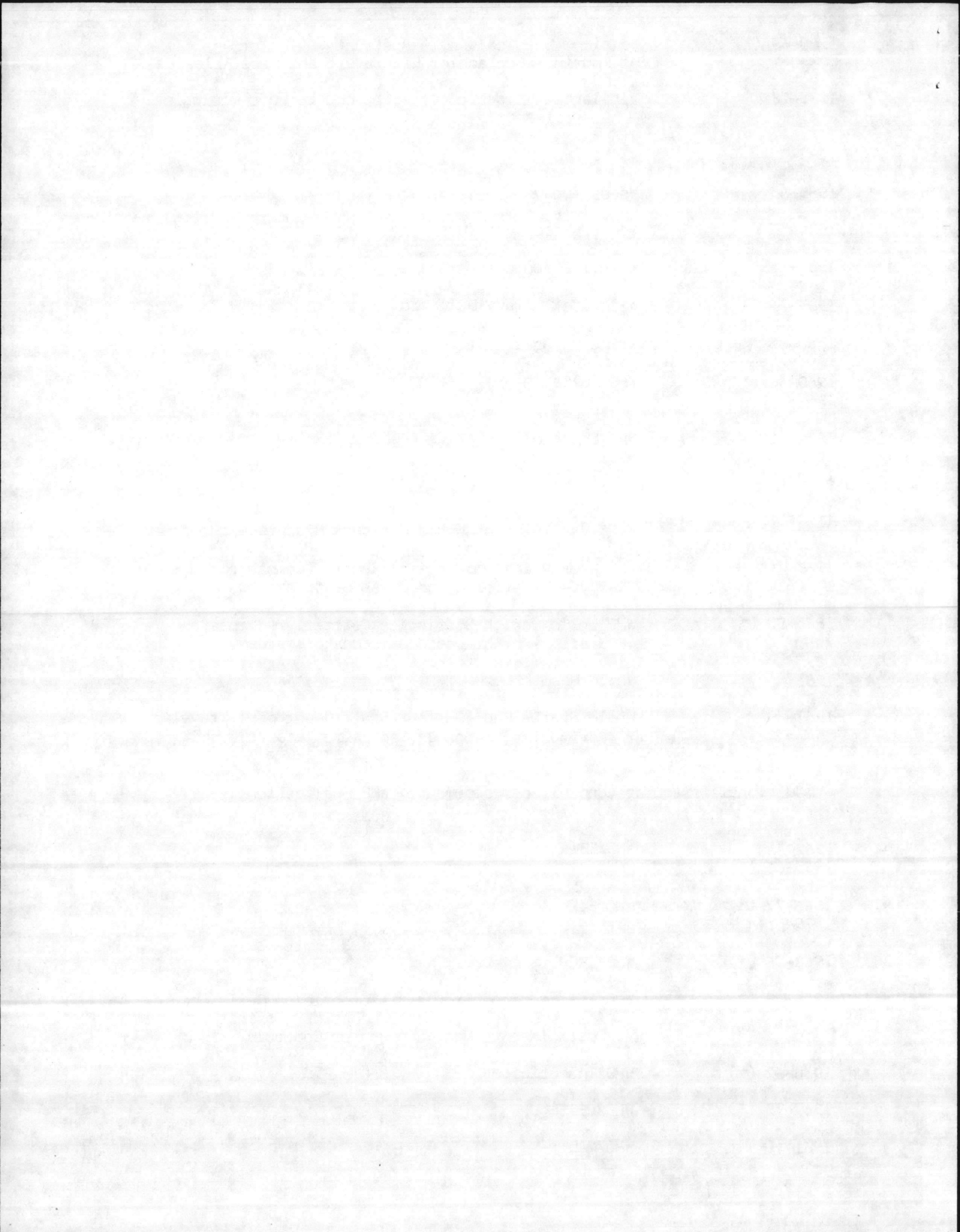

Additional Irregular (unpublished documents) WHO Publications:  
(Continued)

+ **	1966-85 (*)	WHO/ONCHO
+	1968- (*)	WHO/SCHISTO
+ **	1968-78 (*)	WHO/TOX
+	1970-76 (*) 1978- (*)	WHO/VBC
+ **	1962-69 (*)	WHO Vector Control

NOTE: 229 = Total Number of periodicals

128 = Periodicals currently received and selectively coded

12



DEPARTMENT OF DEFENSE  
DEFENSE PEST MANAGEMENT INFORMATION ANALYSIS CENTER  
ARMED FORCES PEST MANAGEMENT BOARD  
FOREST GLEN SECTION, WRAMC  
WASHINGTON, D. C. 20307-5001

REPLY TO  
ATTENTION OF

AFPMB/DPMIAC

15 June 1987

TO: All DoD Pest Management and Natural Resource Professionals  
From: Chief, Defense Pest Mgmt Info Analysis Center  
SUBJECT: Updates to the Directory of DoD Pest Management and Natural Resource Professionals

1. Enclosed is a list of additions and changes which we have received since the Directory was distributed in October.
2. Please keep us informed of any corrections and/or changes to your current address as printed in the Directory or on the attached list. Use page 002 of the Directory, the enclosed change of address form or contact Mrs. Mary Truitt of DPMIAC (Tel. (301) 427-5365 Autovon: 291-5365) to provide changes.
3. Also enclosed is a copy of the Index of Periodical Holdings in the Defense Pest Management Information Analysis Center.

3 Encl  
as

Frederick J. Santana  
CDR, MSC, USN  
C, DPMIAC

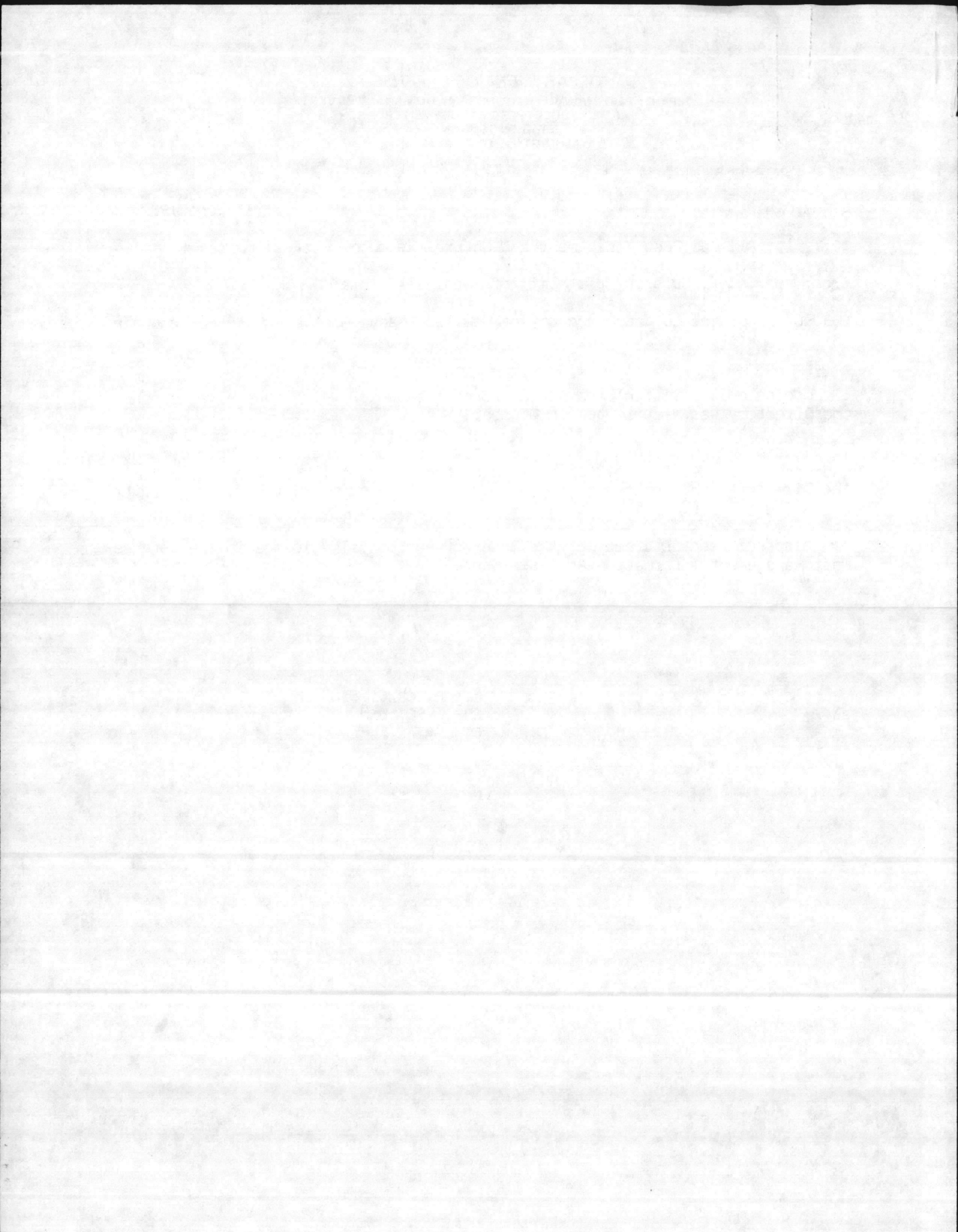

CORRECTIONS TO THE DIRECTORY

	<u>Page</u>	<u>Address</u>
1.	002	<u>Send Directory Changes To:</u> Defense Pest Mgmt Info Analysis Ctr AFPMB, Forest Glen Section, WRAMC Washington, DC 20307-5001
2.	004	<u>Abercrombie:</u> Change phone number to 486-7211/8357
3.		<u>Adams:</u> Add to name (Code 242B) Change phone number to 445-2369 & 565-2369
4.	005	<u>Armstrong:</u> Delete
5.		<u>Arnott:</u> Change Chief, ESB, USAEHA (HSHB-MS-P) Field Support Activity to Chief, ESB (HSHB-AM-P) USAEHA - Field Support Activity Change phone to (404) 752-2564/78 & 572-2564/78
6.	006	<u>Barton:</u> Change address to Route 1 - Box 104 1299 Z Avenue E. Athens, MI 49011 729-4554
7.		<u>Beavers:</u> Change address to NEPMU-5 Naval Station, Box 143 San Diego, CA 92136 (619) 696-6130 & 958-6130
8.	007	<u>Beisler:</u> Delete
9.	008	<u>Boardman:</u> Change address to C, Navigation & Flood Control Branch P.O. Box 898 Anchorage, AK 99606-0898
10.	009	<u>Braswell:</u> Change ATTN: to ATZH-DIC, USAC & FG FAC DIV DIS Zip code to 5060 4218/4148/2872
11.		<u>Brower:</u> Change LM to AG Harry Diamond Labs (SCLIS-FE-EM) 2800 Powder Mill Road Adelphi, MD 20783 (301) 394-2222 & 290-2222

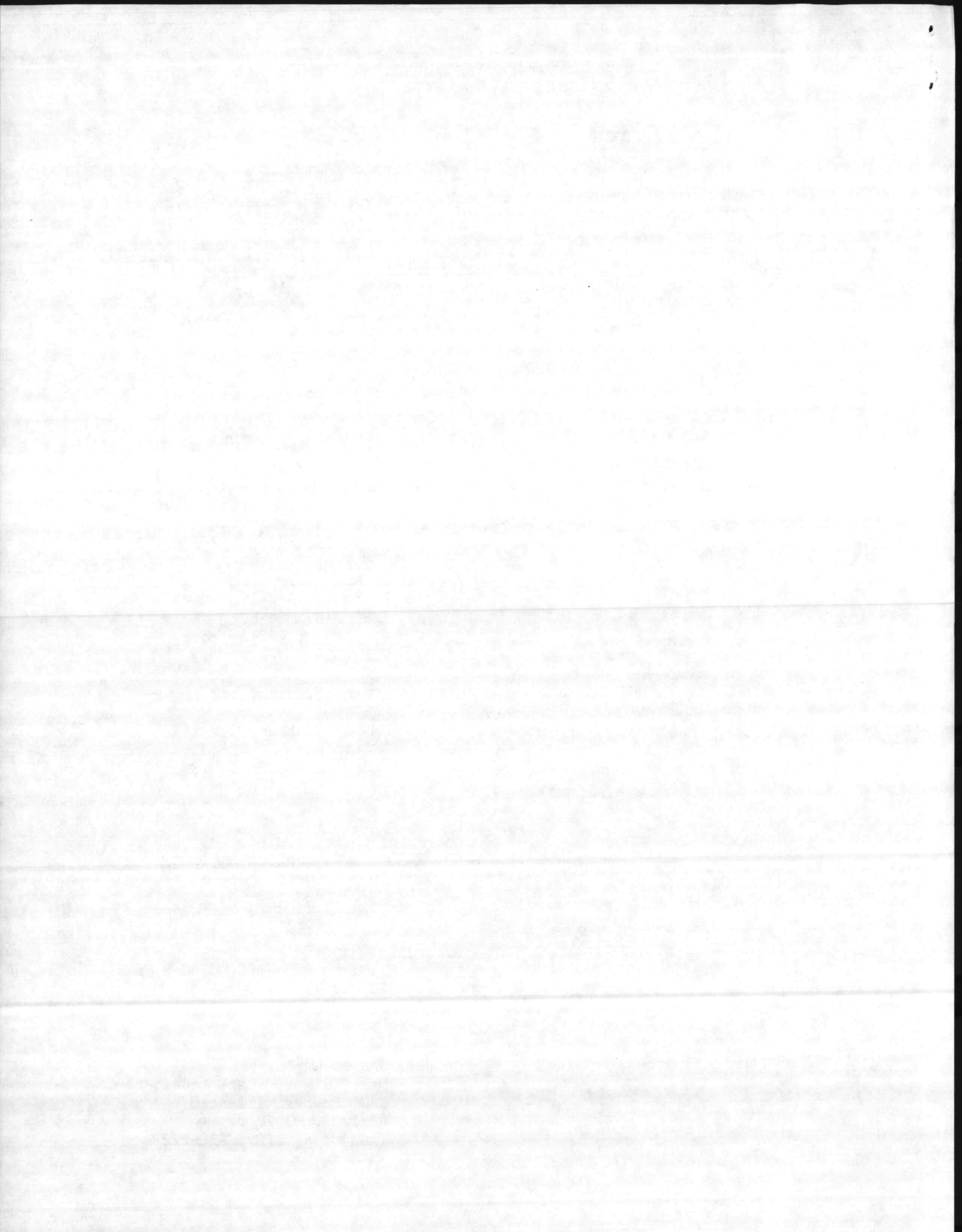



12. 010 Butler: Change ATTN: to  
SMCAR-ISE-OBL, Bldg 302-N  
Add to zip code 5001  
724-4653/4691 & 880-4653

13. Candler: Change address to  
10500 Forum Place  
Houston, TX 77036  
(713) 995-1112

14. Capuzzo: Delete

15. 012 Clark: Add ME  
Change Dr. to LCDR

16. Conroy: Delete

17. 013 Cox: Delete

18. 014 Currie: Change phone number to  
557-5017

19. 015 Divittorio: Delete

20. 016 Edgecomb: Change 2LT to CPT

21. Egan: Change phone number to  
752-2564 & 572-2564

22. Eiseman: Change AG to CE  
366 CSG/DEEV  
Mountain Home AFB, ID 83648  
(208) 828-2750 & 857-2750

23. 017 Endris: Add to zip code 0848

24. Fisher: Change phone number to  
(616) 961-5910  
Auto: 932-5910 & FTS: 552-5910

25. 018 Fordham: Change Wayne to Herbert W.  
HQ, USAF/LEEVN  
Bolling AFB  
Washington, DC 20332-5000

26. Frick: Change phone number to  
274-7541 & 284-7541

27. Fujii: Delete

28. Gale: Add to zip code 6288

29. Gale: Delete 24 from phone number

30. 020 Gottschalk: Change ATTN: to  
AETV-HNU-EB/Land Management  
320-8440

31. 022 Hassut: Change CPT to MAJ

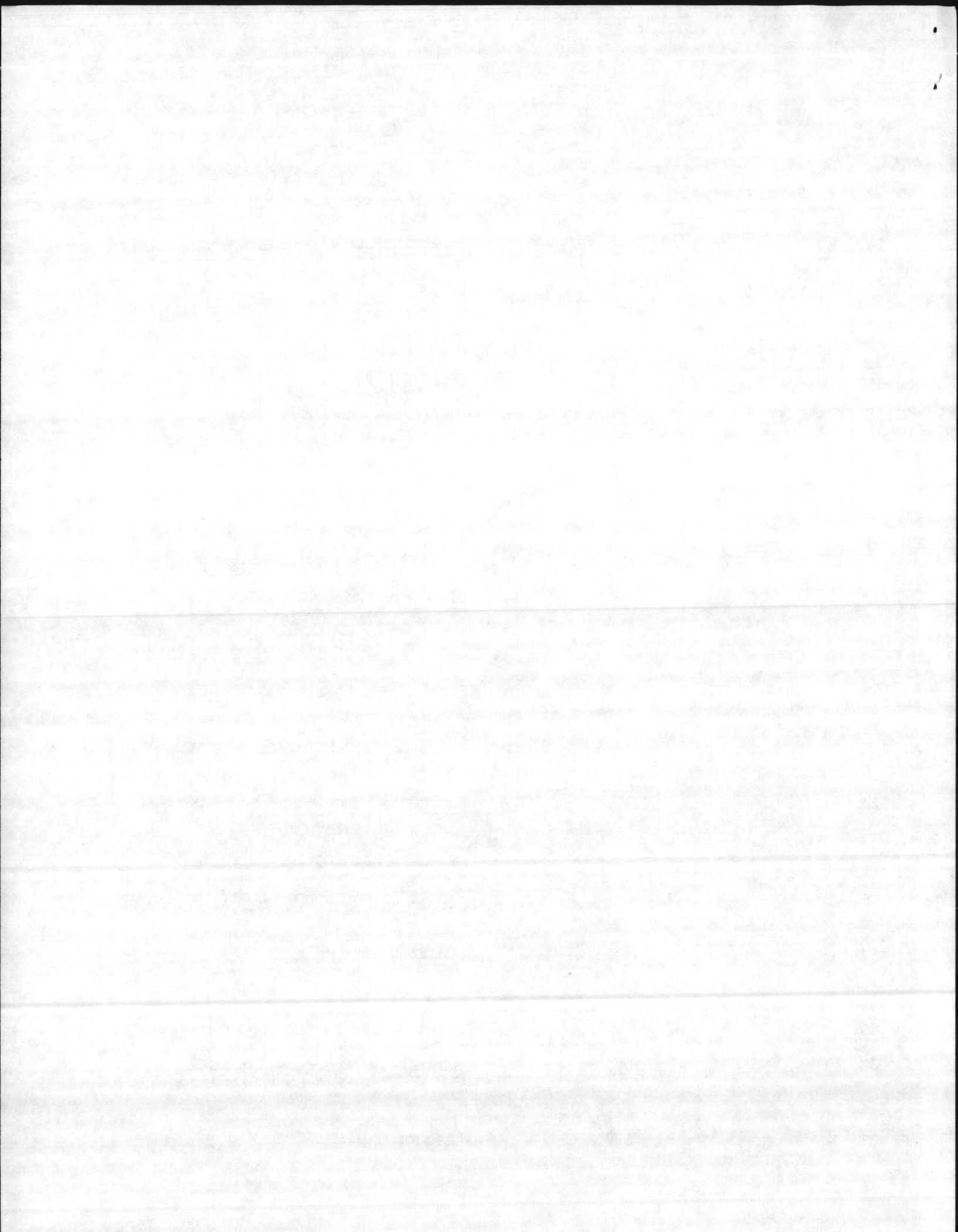

32. 023 Hensley: Change phone number to  
671-8101/08 & 584-8101

33. 023 Herbert: Change ATTN: to  
AFZF-DE-ENV  
Building 1938  
Zipe code to 5057  
287-2885 & 737-2885

34. Holmberg: Change Chief, Natural to  
Sacramento District Corps  
of Engineers  
Add to zip code 4794  
551-2112 & 460-2112

35. 023 Holness: Delete

36. 024 Hough: Change  
HQ, USAREUR - USA ISAE to  
ODCSENG-ROHRBACH

37. 025 Husted: Change ATTN to  
DPSC-HSTX (Alameda)

38. Johnson, CAPT Jerry M.: Change address  
Commandant (G-KOM-4)  
US Coast Guard  
Washington, DC 20590-0001

39. 026 Jones, Mr. Melvin J.: Delete

40. Kanour: Change address to  
Preventive Medicine Service  
Marine Corps Base  
1st Med Batt, 1st FSSG  
725-3203/4018 & 365-3203/4018

41. 027 Kasa: Change ATTN: to  
DPSC-HSTX  
Add to zip code 8419

42. 028 Knouf: Change Ken to Kenneth G.  
ATTN: STEJP-DEH

43. Konermann: Delete

44. Korch: Change address to  
PMPMD - USAEHA  
Aberdeen Proving Ground, MD 21010-5422  
(301) 671-3015/3792 & 584-3015/3792

45. Kverno: Delete

46. 029 Lamb: Change autovon 970 to 523

47. Lamdin: Change ODR to CAPT

48. Lang: Change HQ MAC/DEMU to  
HQ MAC/DEEV  
Autovon to 576-5764

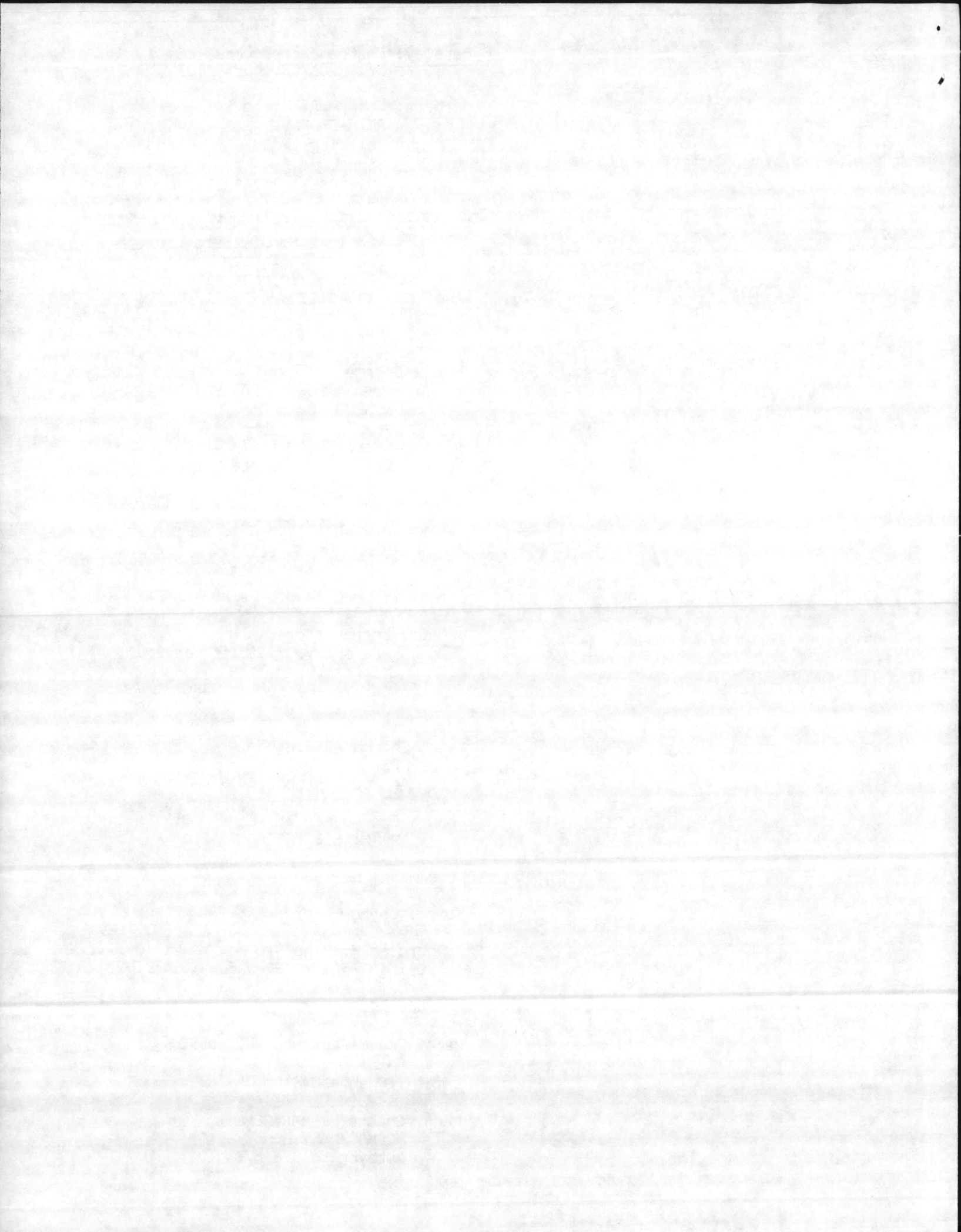

49. 031 Lombard: Delete

50. 032 Maiello: Change phone number to  
445-2931 & 565-2931

51. 033 Masse: Change phone number to  
981-4048/2464 & 858-4048/2464

52. McFarlane: Change phone number to  
961-5868  
Auto: 932-5868 FTS: 552-5868

53. 034 Mendez: Change address to  
US Army South  
USA Garrison, Panama  
ATTN: SOGA-EHB  
APO Miami 34004-5000  
285-4867/68

54. 035 Milberg: Change Ft. L. J. Mc Nair to  
Ft. Myer/B & G Branch  
Arlington, VA 22211-5050  
(202) 696-3815 & 226-3815

55. 036 Murdoch: Change zip code to 34011

56. 037 Noble: Change phone number to  
(616) 961-7412  
Auto: 932-7412 FTS: 552-7412

57. 038 Peter: Delete

58. 039 Phillips: Change address to  
C, Environmental Planning & Analysis  
Division  
AFFTC/DEV  
Edwards AFB, CA 93523-5000  
(805) 277-8092  
Autovon: 527-8092

59. Popella: Delete

60. 040 Powell: Change phone number to  
233-4105

61. Prather: Change address to  
OIC, Prev Med Svc (ATL)  
USAMEDDAC Panama - PSC Box 227  
APO Miami 34008  
89-4106/4701  
Autovon: 289-4106/4701

62. Pratt: Change MAJ to MAJ(P)

63. 41 Rambo: Add to name  
E. (Code 892)  
Add to zip code 5409

64. Rappaport: Change phone number to  
671-8101 & 584-8101

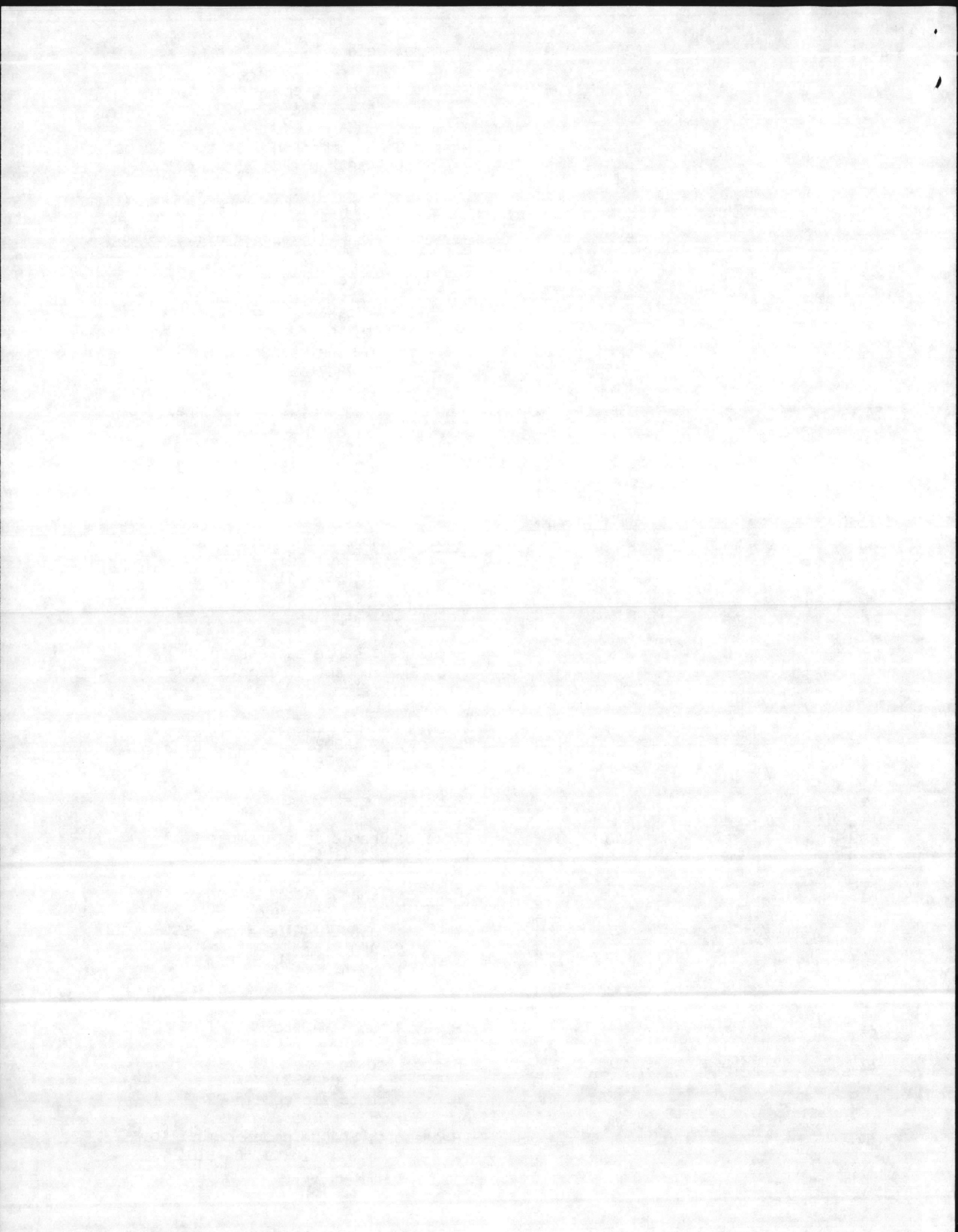

65. 042 Ruth: Delete

66. 043 Sandy: Delete

67. 045 Simmons: Delete

68. Smith 1Lt Lewis K.: Delete

69. Smith 1Lt Mike: Delete

70. 046 Solyan: Change phone number to  
961-5872  
Auto 932-5872 FTS: 552-5872

71. Spencer: Change phone number to  
727-2270 & 680-2270

72. Stanley: Change address to  
48th Support Battalion  
C Company  
Change zip code to 76546

73. 047 Stevenson: Change LT to LCDR

74. 048 Stroukoff: Change phone number to)  
724-2215 & 880-2215

75. Tarnopol: Change Fort Myers to  
Fort Myer

76. 049 Thomas: Delete

77. Trosper: Change address to  
DPMIAC/AFPMB  
Forest Glen Section, WRAMC  
Washington, DC 20307-5001  
(202) 427-5365/66  
Autovon: 291-5365

78. 050 Tschirhart: Delete

79. Turnbow: Change address to  
Directorate of Engineering &  
Housing  
Building 1404  
Fort Rucker, AL 36362-5137  
255-4901 & 558-4901

80. 051 Vorgetts: Change Mr. to Dr.

81. Wainwright: Delete

82. 052 White: Change address to  
ODCSENGR - ROHRBACH  
APO New York 09102-5347  
06221-57-9073/8125  
Autovon: 370-9073/8125

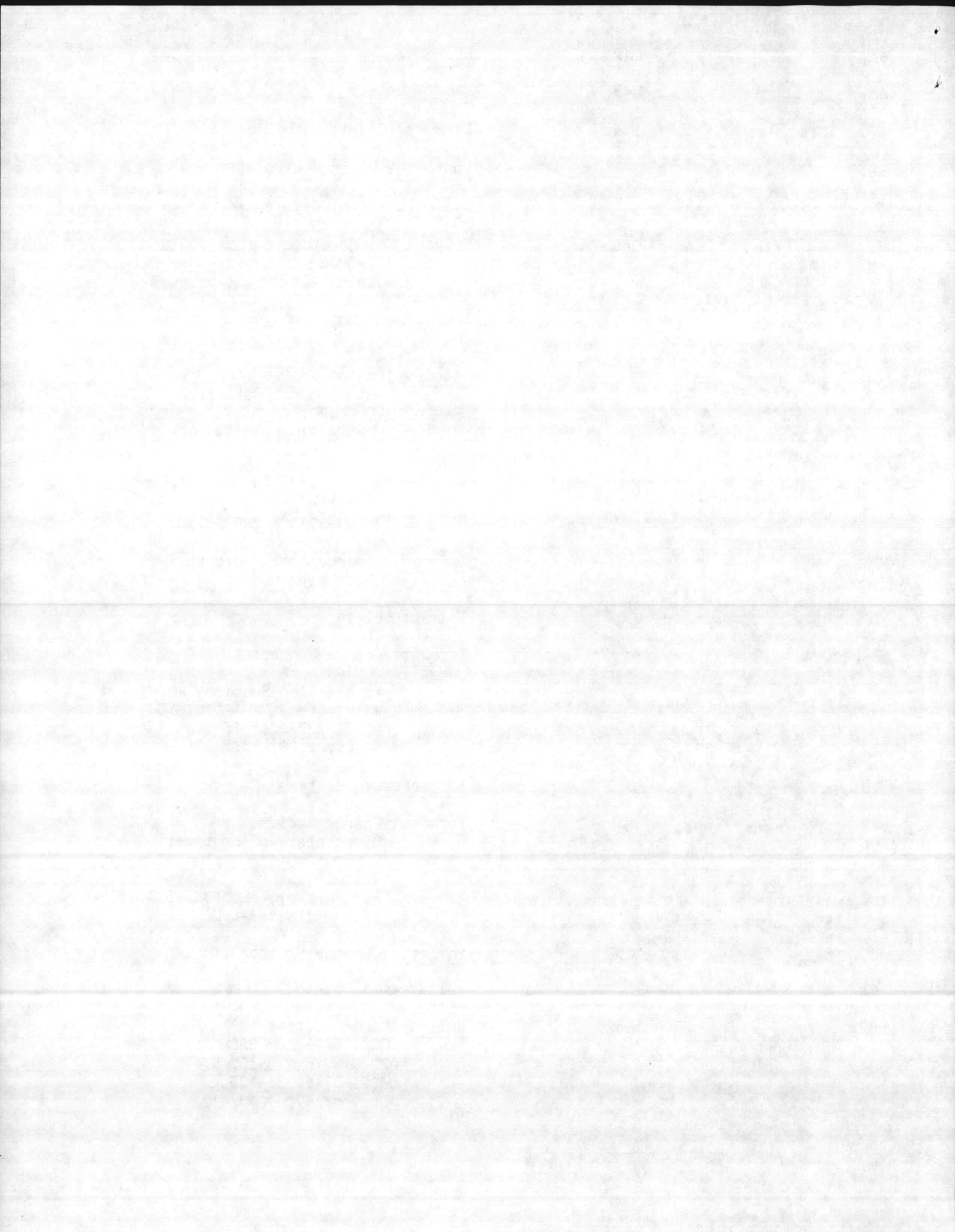



- 83. 052 Whitmer: Change address to  
342nd Medical Detachment (LA)  
5515 N.W. 15th Avenue  
Fort Lauderdale, FL 33309-2799  
(904) 772-9616
  
- 84. 053 Winters: Delete
  
- 85. 054 Wueste: Delete
  
- 86. Yamasaki: Change address to  
Paints & Chemical Commodity Ctr.  
9-FTE-10, GSA Center  
Change zip code to 98001
  
- 87. 055 Young, LTC Jimmy L.: Change address to  
Defense Logistics Agency - DLA-WS  
Cameron Station  
274-6357 & 284-6357

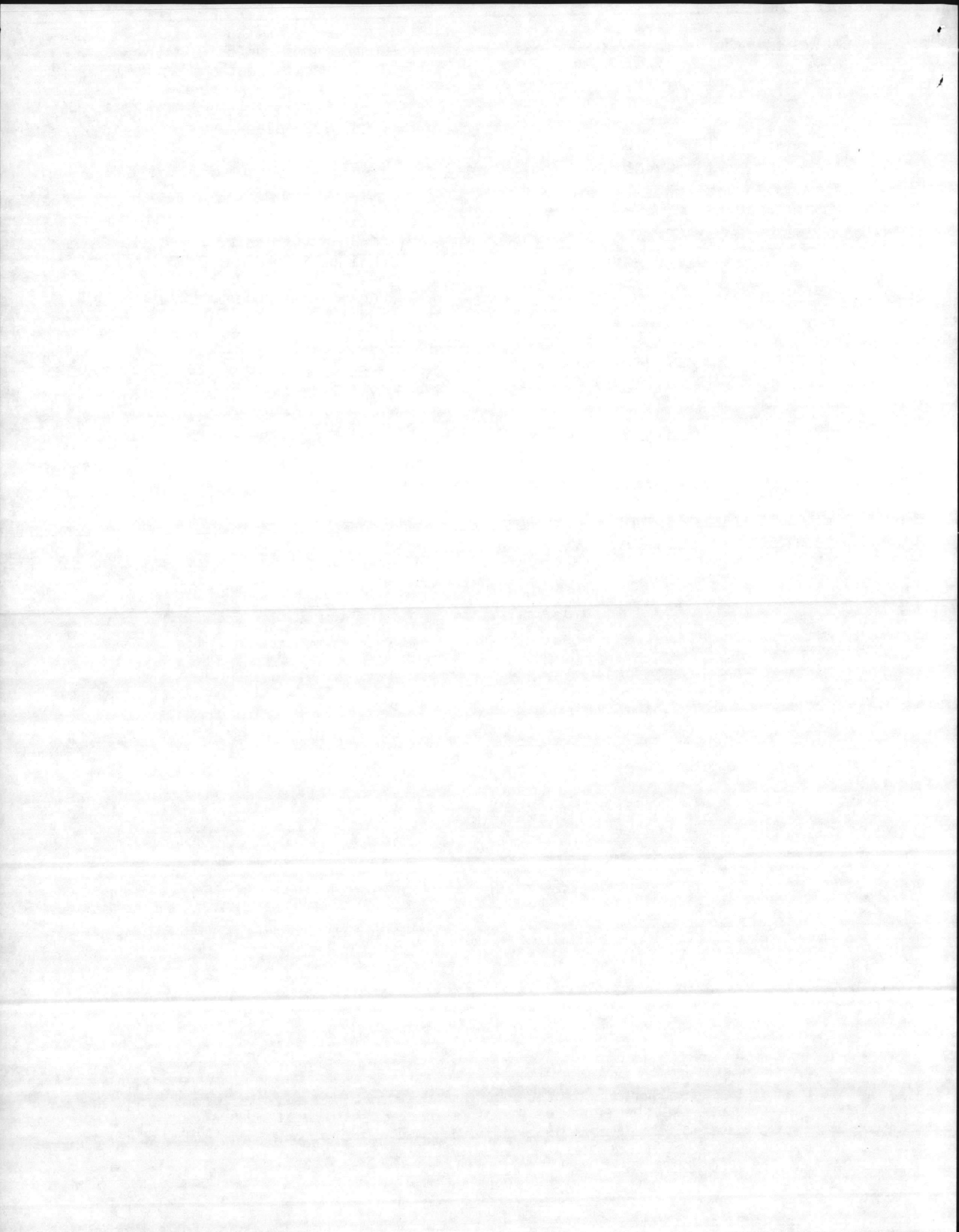

ADDITIONS TO THE DIRECTORY

AG Anderson, Mr. Robert S. (714) 383-3909  
63 CES/DEEV Autovon: 876-3909  
Building 409  
Norton AFB, CA 92409

WB Bryan, Mike (Code 892a) (301) 863-3670  
Environmental Protection Office, (PW) Autovon: 356-3670  
Naval Air Station  
Patuxent River, MD 20670-5409

GB Bunner, Ms. Bobbie L. (301) 663-7237  
USABRDL - Building 568 Autovon: 343-7237  
Fort Detrick, MD 21701-5010

NR Chilton, Ms. Patricia (512) 479-2494  
67th CSG/DEEV Autovon: 685-2494  
Bergstrom AFB, TX 78743-5000

Garrett, LTC Joseph, VC, USA (214) 780-3604/04  
ATTN: Staff Veterinarian Autovon: 967-3604/05  
AAFES/QAV/P.O. Box 660202  
Dallas, TX 75266-0202

WB Hagan, William M. (805) 277-8092  
AFFTC/DEV Autovon: 527-8092  
Edwards AFB, CA 93523-5000

CE Jones, Mr. Ralph (817) 851-6559/2195  
3770 Technical Training Group Autovon: 736-6559/2195/2072  
TTGIC/43  
Sheppard AFB, TX 76311

GB Koenen, Mr. Brent A. (907) 353-6489  
AFVR-FW-DEEN Autovon: 353-6489  
Fort Wainwright, AK 99703-5500

AG Loesche, Ms. Annerose Germany  
CDR Hanau Milcom Autovon: 322-8440  
ATTN: AETV-HNU-BG/Land Management  
APO New York 09165

CE Main, Dr. Andrew J. Egypt  
Head, Medical Zoology Department Autovon: 820-727  
NAMRU-3  
FPO New York 09527

NR Manning, Capt Ed, USAF (919) 736-5513  
4 CSG/DEEV Autovon: 488-5513  
Seymour Johnson AFB, NC 27531-5005

CE McHugh, Dr. Chad P. (512) 536-3471  
USAFSAM/EKED Autovon: 240-3471  
Brooks AFB, TX 78235-5301

ME Milstrey, CPT Eric G. (301) 677-5281/6502  
ESD, USAEHA - FSA North Autovon: 923-5281/6502  
Field Support Activity  
Fort Meade, MD 20755-5225

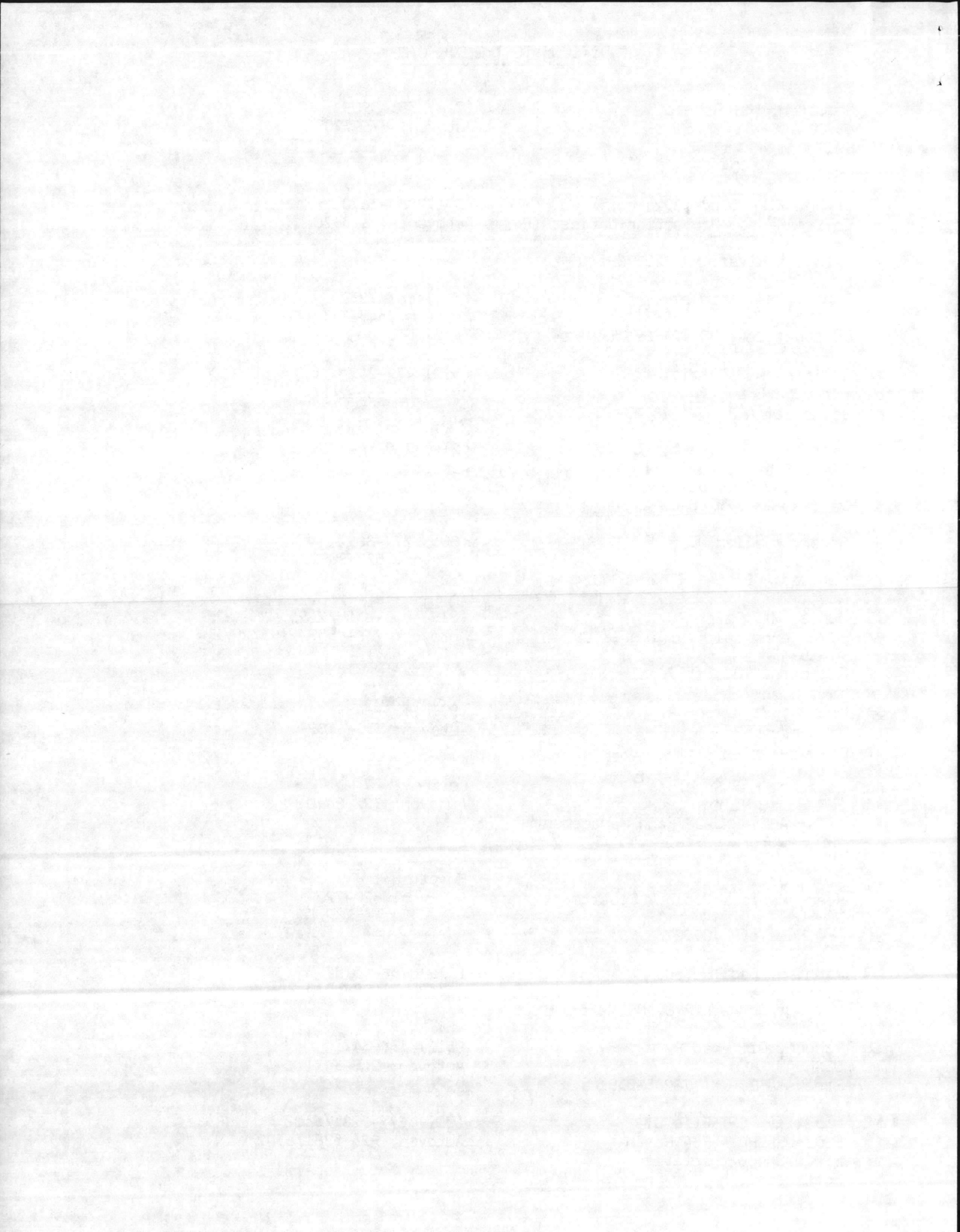

CE Perich, Dr. Michael J. (301) 663-7237  
USABRD - Building 568  
Fort Detrick, MD 21701-5010  
Autovon: 343-7237

NR Potter, Laurin (301) 878-5878  
U.S. Garrison Fort Ritchie  
ATTN: ASNJ-DEH-EP&S  
Fort Ritchie, MD 21719-5010  
Autovon: 277-5878

Roberts, LTC Christopher A. M. (202) 797-3272  
Australian Army Staff/Embassy of Australia  
1601 Massachusetts Avenue, N.W.  
Washington, DC 20036

Rogers, Dr. John (202) 343-4088  
Chief, Division of Environmental Contaminants  
US Fish & Wildlife Services  
Washington, DC 20240

NR Rush, Mr. Christopher (805) 277-8092  
AFFTC/DEV  
Edwards AFB, CA 93523-5000  
Autovon: 527-8092

Taplin, Prof. David (305) 547-6214  
University of Miami/Department of Dermatology  
P.O. Box 016960 (R-122)  
Miami, FL 33101

Wade, Dr. Dale A. 436-8657  
ADC-APHIS-USDA  
6505 Belcrest Road, Room 565A-FB  
Hyattsville, MD 20782

CE Waligora, Mrs. Sharron (804) 878-2288  
ATTN: ATZF-FE  
Fort Eustis, VA 23604-5332  
Autovon: 927-2288

CE Walker, Mr. Gary L. (215) 952-3831  
DPSC - HSTX  
2800 South 20th Street  
Philadelphia, PA 19101  
Autovon: 444-3831

Welch, CW2 John M. (214) 780-3604/05  
ATTN: Staff Veterinarian  
AAFES/QAV/P.O. Box 660202  
Dallas, TX 75266-0202  
Autovon: 967-3604/05

WB Winchell, Mr. Clark S. (619) 725-3528/4512  
Marine Corps Base  
Natural Resources Office/Building 25154  
Camp Pendleton, CA 92055  
Autovon: 365-4512

Wood, Mr. John R. (301) 436-8657  
ADC-APJIS-USDA  
6505 Belcrest Road, Room 565A-FB  
Hyattsville, MD 20782

NR Wood, Mr. Robert W. (805) 277-8092  
AFFTC/DEV  
Edwards AFB, CA 93523-5000  
Autovon: 527-8092



INDEX OF PERIODICAL HOLDINGS IN THE  
DEFENSE PEST MANAGEMENT INFORMATION ANALYSIS CENTER  
ARMED FORCES PEST MANAGEMENT BOARD  
 FOREST GLEN SECTION, WRAMC  
 WASHINGTON, DC 20307-5001  
 TEL: (202) 427-5365; AUTOVON: 291-5365

1965-82 (*) 1985-	Acarologia
1977-81 (*) 1985-	Acta Tropica
1985-	Administrative Management
1983-	Agrichemical Age
1983-	Agricultural Aviation
1983-	Agricultural Engineering
+ 1983-	Agricultural Research
1983	Agronomy Journal
1969-70 1971- (*)	American Journal of Epidemiology
1964-	American Journal of Tropical Medicine and Hygiene
1942-57 (*) 1958-	Annals Entomological Society of America
1965-	Annals Tropical Medicine and Parasitology
1956-	Annual Review of Entomology (Bookshelf)
+ 1984-86 (*)	Aquatics
1973-	Archives of Environmental Contamination & Toxicology
1987-	Bat Research News
** 1982 (*)	Biocontrol News and Information
+ ** 1964-67 (*) 1968-	Biological Abstracts
+ ** 1958-65 (*)	Boletin de la Oficina Sanitaria Panamericana

\* = Incomplete

+ = Journals received free of charge

\*\* = Includes Publications coded previously which we no longer receive

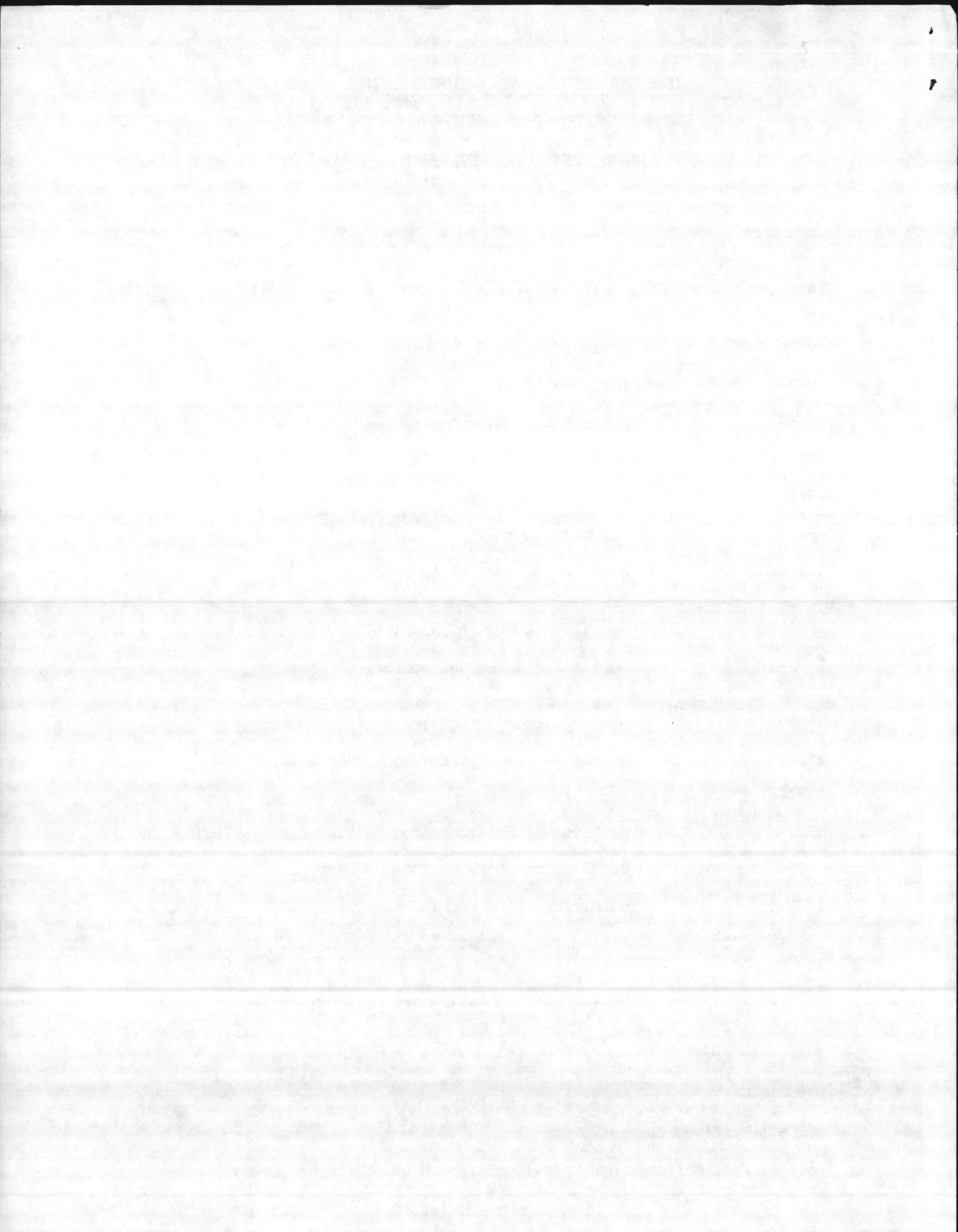



+ **	1975 1977-78	Boletin Informativo
+ **	1964 (*) 1965-77	Botyu-Kagaku (Publication discontinued)
**	1968-83 (*)	ORSTOM (discarded after current SDI)
	1960-61 1963-	Bulletin Entomological Research
	1955-62 (*) 1963-	Bulletin Entomological Society of America
+	1969 1(2)- (*) 1970-	Bulletin Entomological Society of Canada
	1967-	Bulletin Environmental Contamination & Toxicology
**	1973- (*)	Bulletin Missouri Academy of Sciences
+	1972- (*)	Bulletin Pan American Health Organization
	1965-	Bulletin de la Societe de Pathologie Exotique
	1974-	Bulletin of the Society of Vector Ecologists
	1963-82 (*) 1985-	Cahiers ORSTOM Serie Entomologie Medicale et Parasitologie
+	1979- (*)	California Agriculture
+ **	1956-79 (*)	California Vector Views
	1956-67 (*) 1969-	Canadian Entomologist
**	1970-81	Canadian Journal Zoology
**	1983-84 (*)	Cast
+ **	1965-67 (*) 1968-69	CBE Factors Monthly Survey (Aerospace Technology Division)
	1984-	Chemical Engineering News
	1978-	Chemical Regulation Reporter
**	1965-81 (*)	Contributions of the American Entomological Institute
+ **	1958-75 (*)	Cooperative Economic Insect Report (only maintain coded issues)
**	1976-78 (*)	Cooperative Plant Pest Report (only maintain coded issues)
**	1983-86 (*)	Crop Science
	1978- (*)	Current Contents

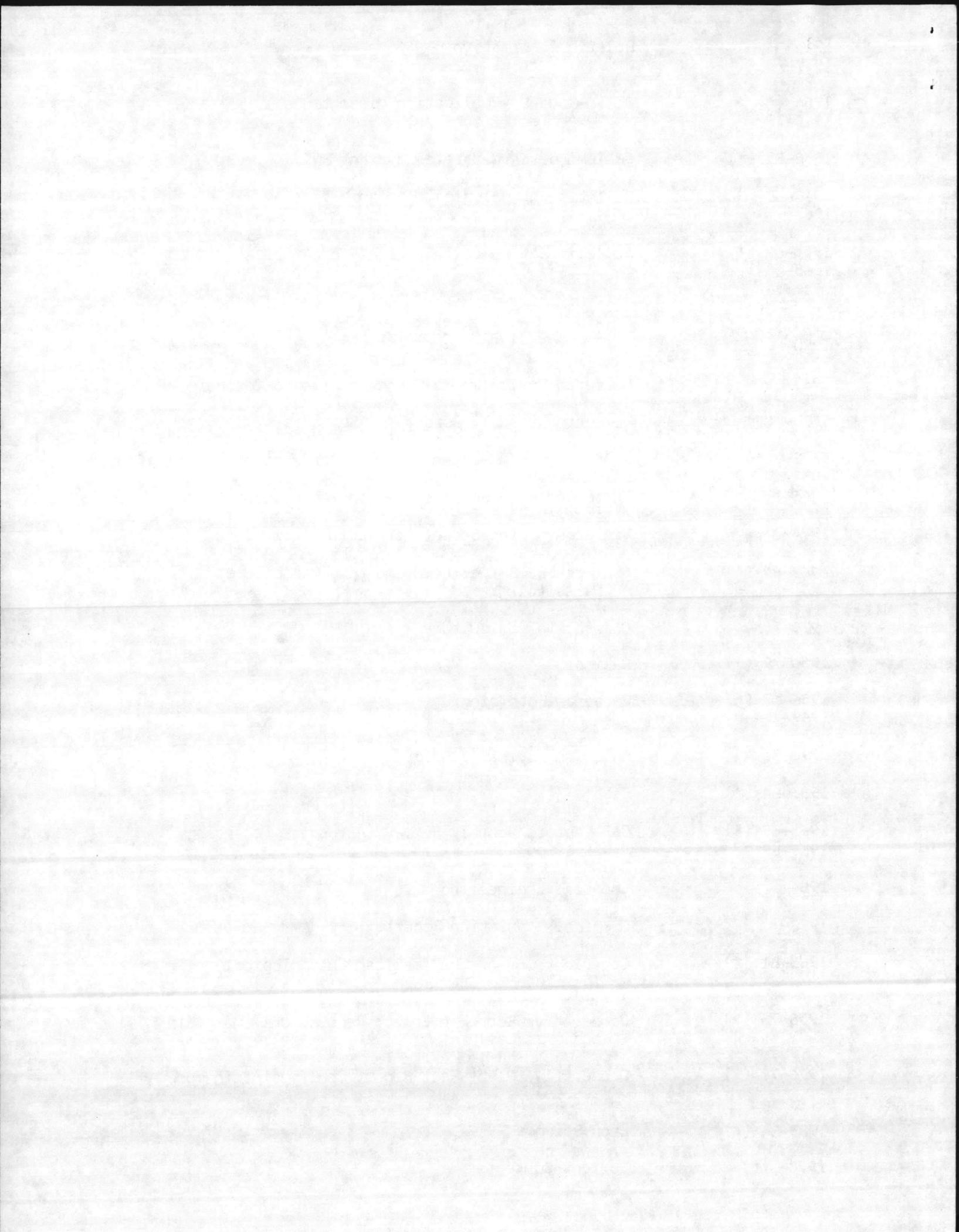

	1984-	Current Contents: Life Sciences
+	1963-	Danish Pest Infestation Laboratory Annual Report
+ **	1973-75	Dengue Newsletter for the Americas (WHO PAHO)
+ **	1975-80 (*)	Dengue Newsletter for Southeast Asia and Western Pacific Regions
+	1981-	Dengue Surveillance Summary
+	1981- (*)	Disaster Preparedness in the Americas
+ **	1968-74 (*)	Down to Earth (DOW Chemical Company)
+ **	1979-	Encephalitis Surveillance
	1979-	Endangered Species
+ **	1962-67	Endemic Disease Bulletin Nagasaki University
+	1987-(*)	Energy & Environmental News
	1969 (*)	Entomological News
	1970-	
	1958-59 (*)	Entomological Review (English translation
	1960-	Russian Entomol. Obozr.)
**	1978-85	Environment Reporter
+ **	1963-64 (*)	Environmental Effects of Materials and Equipment
	1972-	Environmental Entomology
+	1973-83 (*)	Environmental Health Perspectives (DHEW)
+	1978-	Epidemiological Surveillance (formerly Vigilancia Epidemiologia)
+	1985-	Epidemiology Bulletin (Republic of China)
**	1985	The Epidemiology Monitor
	1978-	Federal Register
+	1987-(*)	Fish and Wildlife Reference Service Newsletter
**	1969-81	Florida Entomologist
	1984-	Forest Science
+	1985- (*)	Global Disease Surveillance Report
**	1933-77 (*)	Gorgas Memorial Laboratory Annual Reports
	1979-	Government Reports, Announcement & Index (Discarded after it is reviewed for orders)
	1973-	Great Basin Naturalist

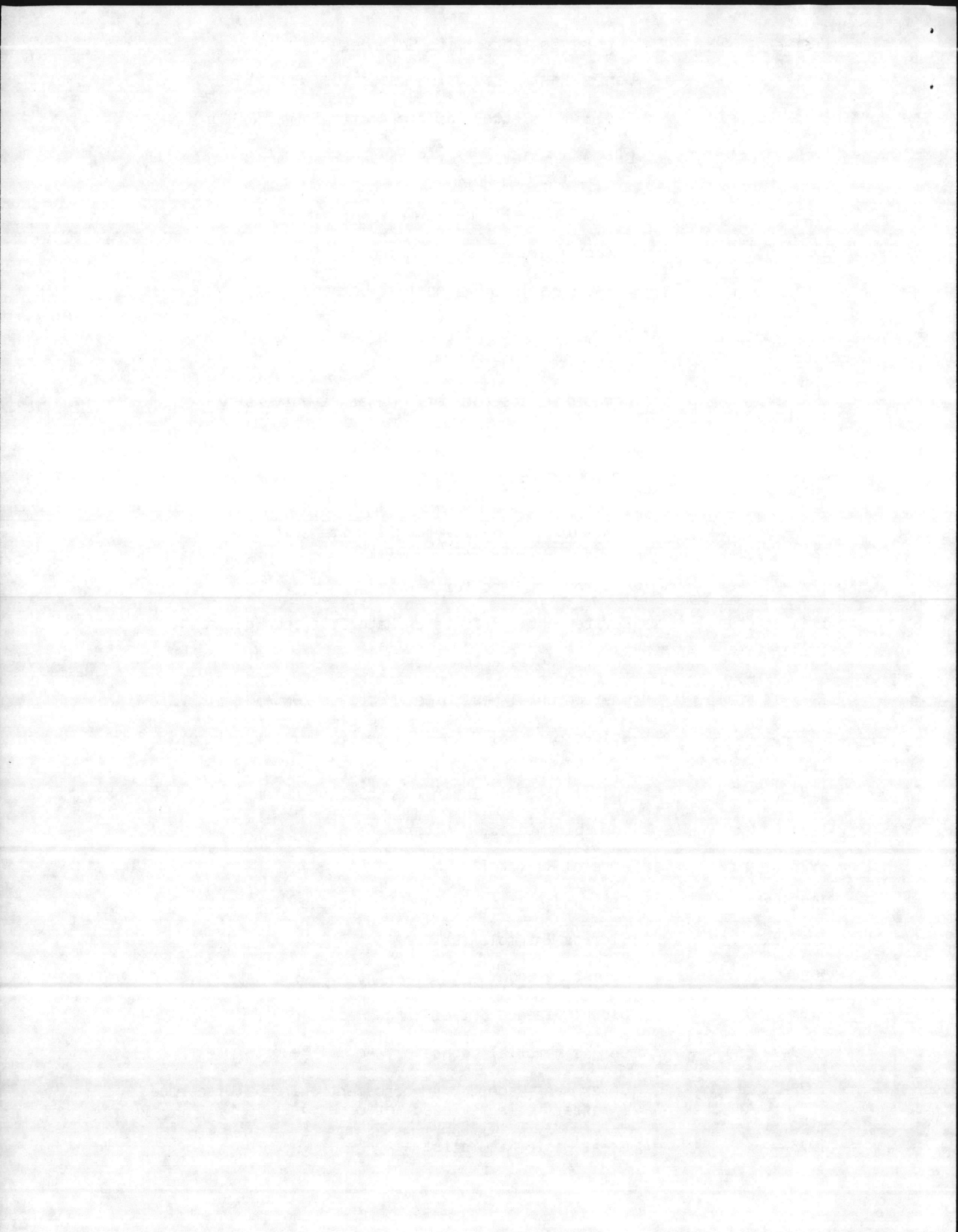

+ **	1966-67 (*) 1968-74	Health Aspects of Pesticides (DHEW - changed to Pesticide Abstracts)
**	1978-86 (*)	Hilgardia
**	1983-86	Hortscience
**	1973-75	Indian Journal of Entomology
+ **	1969-74 (*)	Industrial Vegetation Management (DOW Chemical Co.)
+ **	1975-78 (*)	Informative Bulletin
	1987-	Insect Science and Its Application
+ **	1967-69	International Epidemiologic Report (DHEW)
**	1985	International Journal of Entomology (Publication discontinued; formerly Pacific Insects)
**	1971-84 (*)	International Journal of Insect Morphology and Embryology
	1968-69 (*) 1970-	International Pest Control
	1981-	IPM Practitioner
	1975-	Israel Journal of Entomology
+	1964-	Japanese Journal Sanitary Zoology
	1984-	Journal of Agricultural Entomology
	1967 [15(6)] 1968-	Journal Agricultural and Food Chemistry
	1985-	Journal of the American Mosquito Control Association
**	1983-86	Journal of the American Society for Horticultural Science
+	1984-	Journal of Aquatic Plant Management
+ **	1976 [2(2)] 1977-85	Journal Association of Military Dermatologists
	1975-	Journal Australian Entomological Society
	1987-	Journal of Communicable Diseases
	1931-43 (*) 1944-	Journal of Economic Entomology
**	1971-75	Journal of Entomology Series A and B (formerly Proceedings Royal Entomological Society of London, Series A & B)
	1986-	Journal of Entomological Science (formerly Journal of Georgia Entomological Society)

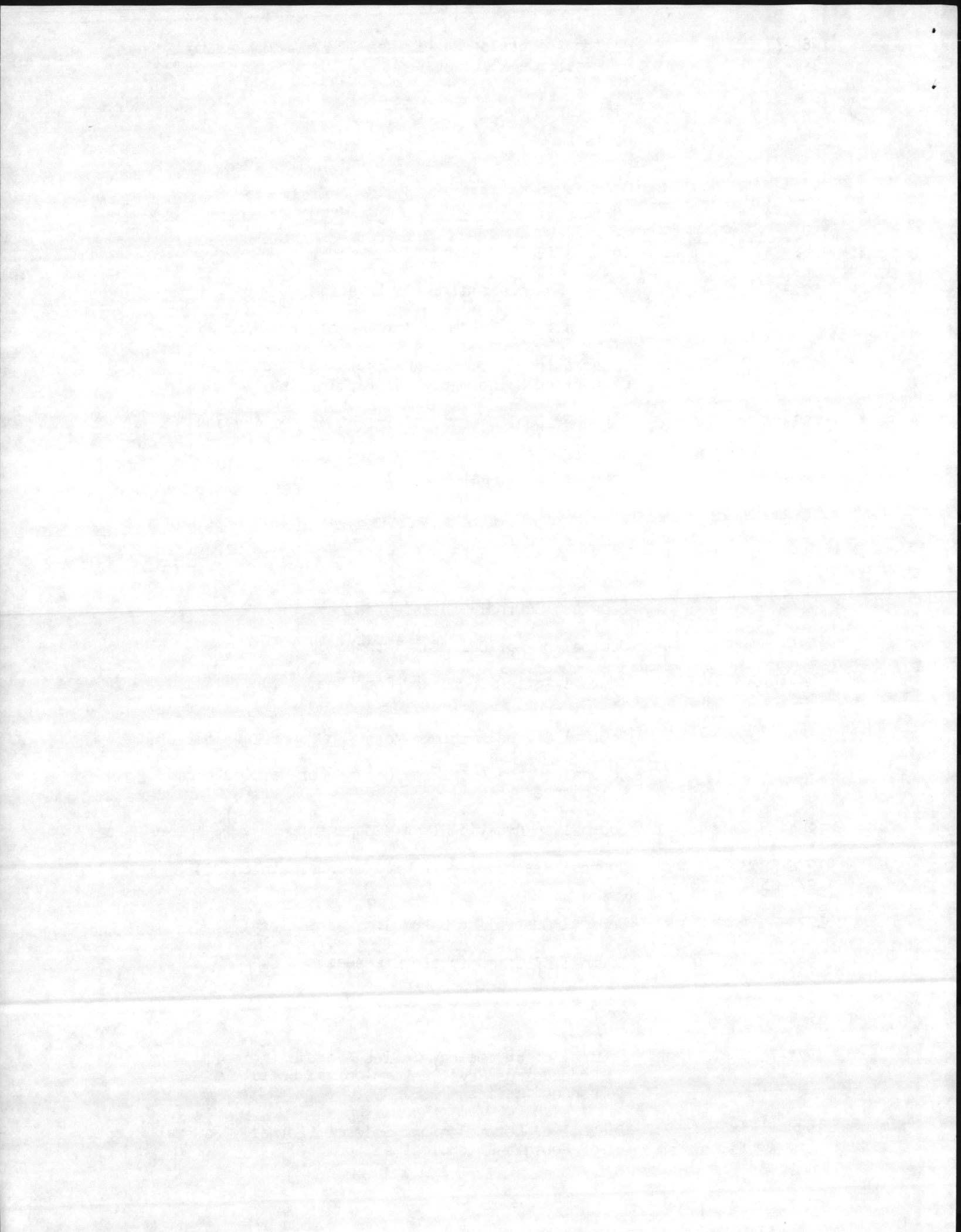

1985-	Journal of Environmental Quality
1983-	Journal of the Florida Anti-Mosquito Association
1984-	Journal of Forestry
** 1969-85	Journal of Georgia Entomological Society
** 1967-76	Journal of Insect Physiology
1967-	Journal of Invertebrate Pathology
1967-	Journal of Kansas Entomological Society
1964-	Journal of Medical Entomology
1967-	Journal of Parasitology
1983-	Journal of Range Management
1966-68 (*) 1969-	Journal of Stored Products Research
1966-	Journal of Tropical Medicine and Hygiene
1983-	Journal of Wildlife Management
+ 1987-	Kansas Pesticide Newsletter
** 1983 (*) 1984-86	Land Letter
+ ** 1963-73 (*)	Late News About Insects and Diseases
+ 1981- (*)	Medical Bulletin of the US Army
+ ** 1969-84 (*)	Melanderia
+ 1963- (*)	Memoirs Entomological Society of Canada
1980-	Military Medicine
1961- (*)	Morbidity and Mortality Weekly Report (DHEW) Complete 3 yrs. - prior uncoded issues discarded)
** 1973-82	Mosquito Annual Review
+ 1984-	Mosquito-Borne Diseases Bulletin
** 1944-46 (*) 1947-84	Mosquito News
1969-	Mosquito Systematics
+ 1987-(*)	NAL Agricultural Libraries Information Notes
+ ** 1960-81 (*)	National Clearinghouse for Poison Control Centers
+ ** 1960-85	National Pest Control Association Technical Release
+ ** 1969-81	National Pest Control Association Service Letters

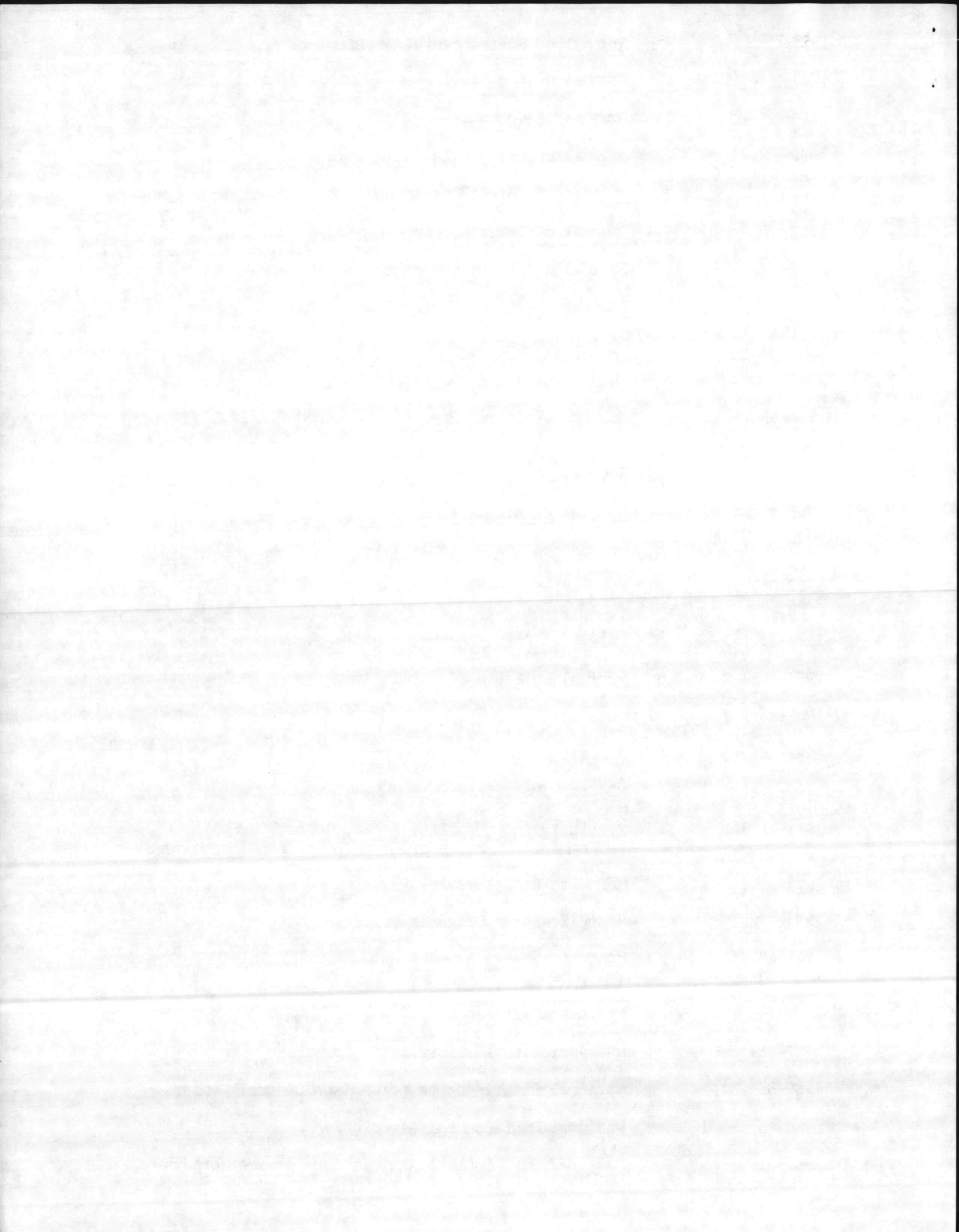



- \*\* 1965-75 (\*) National Pest Control Operators News (Publication discontinued)
- 1986- National Wildlife
- 1986- New Jersey Vector Surveillance
- \*\* 1986 New Scientist
- + 1976-80 (\*) Newsletter on Dengue, Yellow Fever and Aedes Aegypti in the Americas (WHO PAHO)
- + 1987- (8) Occupational & Environmental Health Notes
- + 1987- (\*) OCLC Newsletter
- 1987- On-line Data Accession
- + 1987- (\*) Outdoor News Bulletin
- + \*\* 1960-82 (\*) Pacific Insects (Publication discontinued; changed name to International Journal of Entomology)
- + 1980- Pan American Health Organization Epidemiological Bulletin
- 1982- Pan-Pacific Entomologist
- \*\* 1967-75 Parasitology
- 1985- Parasitology Today
- 1984- (\*) Park Maintenance
- 1961- Pest Control
- 1980- Pest Control Technology
- 1981- Pest Management
- + \*\* 1974-81 Pesticide Abstracts (formerly Health Aspects of Pesticides)
- 1971- Pesticide Biochemistry and Physiology
- 1986- Pesticide and Toxic Chemical News
- 1987- Pesticide Science
- \*\* 1957-62 (\*)  
1963-79 Pesticides Articles & News Summary (PANS)
- + 1987- (\*) Pesticides Coordinator Report
- + \*\* 1967-81 (\*) Pesticides Monitoring Journal
- 1976- Physiological Entomology (formerly Proceedings of Royal Entomological Society of London, Series A, 1965-70, which changed to Journal of Entomology, Series A, 1971-75)

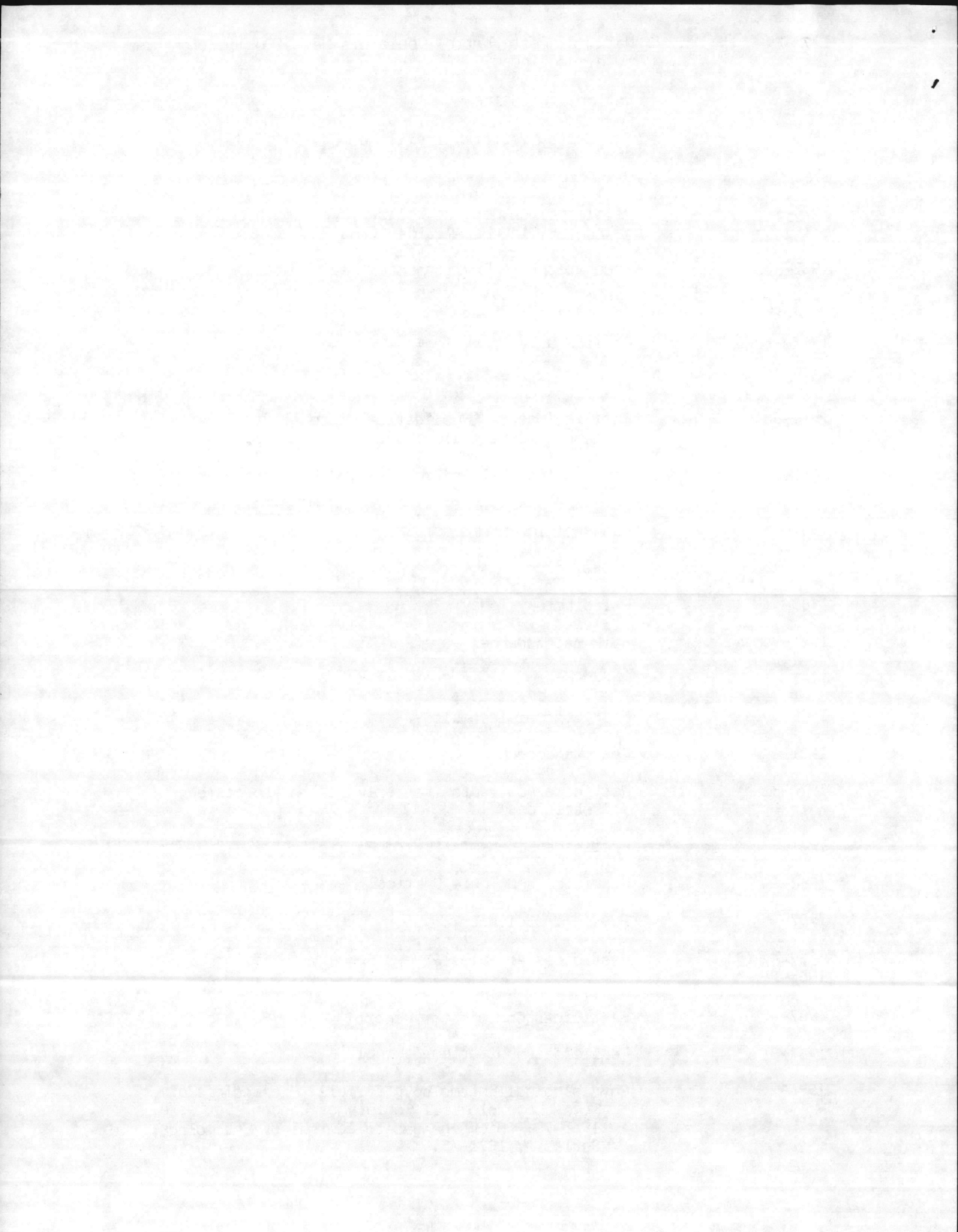

- \*\* 1970-76  
77(\*) Pollution Abstracts
- 1963- (\*) Proceedings Entomological Society Ontario
- 1946- Proceedings of the Entomological Society of  
Washington
- \*\* 1960 Proceedings of the Hawaiian Entomological Society  
1963-79
- 1944-60 (\*) Proceedings of the New Jersey Mosquito Control  
1961- Association
- + 1982- (\*) Proceedings of the Northeastern Weed Science Society
- 1948- Proceedings & Papers of the Annual Conference of the  
California Mosquito and Vector Control Assoc.
- \*\* 1965-66 (\*) Proceedings of the Royal Entomological Society of  
1967-70 London: Series A (changed to Journal of  
Entomology, Series A)
- \*\* 1967-70 (\*) Proceedings of the Royal Entomological Society of  
London: Series B (changed to Journal of  
Entomology, Series B)
- \*\* 1967-68 Vol 32 Proceedings of the Royal Entomological Society of  
London: Series C
- + 1987- (\*) Progress Newsletter
- \*\* 1969-78 Psyche  
1980-81 (\*)
- + \*\* 1961-67 (\*) Public Health Engineering Abstracts (DHEW)  
(Publication discontinued)
- + 1963- Public Health Reports
- + 1957-60 (\*) Pyrethrum Post  
1961-79  
1983 (\*)  
1985 (\*)
- + 1984- Quarterly Bibliography of Major Tropical Diseases  
(WHO Publication in collaboration with DHHS)
- \*\* 1966-83 (\*) Residue Reviews
- \*\* 1958-65 (\*) Review of Applied Entomology Series A  
1949-(\*) Review of Applied Entomology Series B
- + 1981- Schisto Update
- 1968- (\*) Science
- 1984- Science News
- + \*\* 1984-85 Science Trends

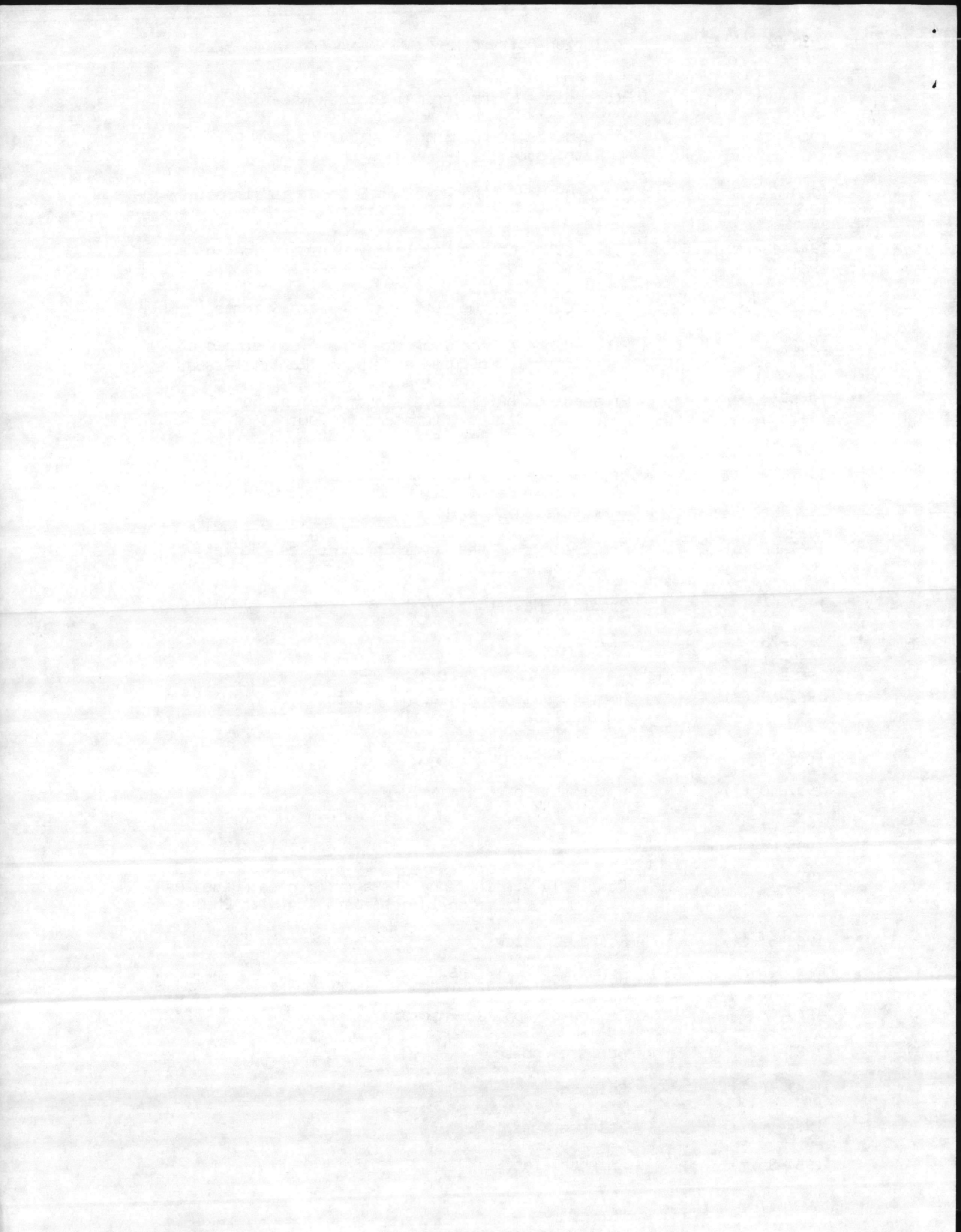

\*\* 1985-86 (\*) Soil Science Society of American Journal

1970- Southeast Asian Journal of Tropical Medicine  
and Public Health

1976- Southwestern Entomologist

+ \*\* 1953-55 (\*) Summary of Investigations (DHEW)  
1956-66

1976- Systematic Entomology (formerly Proceedings of  
Royal Entomological Society of London, Series B,  
1967-70, which changed to Journal of Entomology,  
Series B, 1971-75)

+ 1964- (\*) Tin and Its Uses

1968- (\*) Toxicology and Applied Pharmacology

1978- Toxicicon

1963- Transactions of the Royal Society of Tropical  
Medicine and Hygiene

1987- Tropical Biomedicine

1963- Tropical Diseases Bulletin

\*\* 1976 Tropical and Geographical Medicine

+ 1967- Tropical Medicine, Nagasaki University

+ 1962- [11(2)] Tropical Medicine and Hygiene News  
\*\* 1963-85 (\*)

1980- Tropical Pest Management (formerly PANS)

+ \*\* 1979-1986 (\*) Tsetse and Trypanosomiasis Information Quarterly

+ 1963-70 (\*) US Army R and D News Magazine

+ \*\* 1967-71 (\*) US Navy Medical Newsletter

+ 1963-81 (\*) USDA Quarterly Reports - Entomological Research  
on Insects of Military Importance by Insects  
Affecting Man and Animals Research Laboratory

+ \*\* 1982-83 (\*) USDA Semiannual Reports - Entomological Research  
on Insects of Military Importance by Insects  
Affecting Man and Animals Research Laboratory

+ 1984- (\*) USDA Summary of Annual Research - Entomological  
Research by Insects Affecting Man and Animals  
Research Laboratory on Insects of Military  
Importance

+ 1987- (\*) US National Committee for Man and the Biosphere -  
MAB Bulletin

+ \*\* 1961-72 Vector Control Briefs (DHEW)

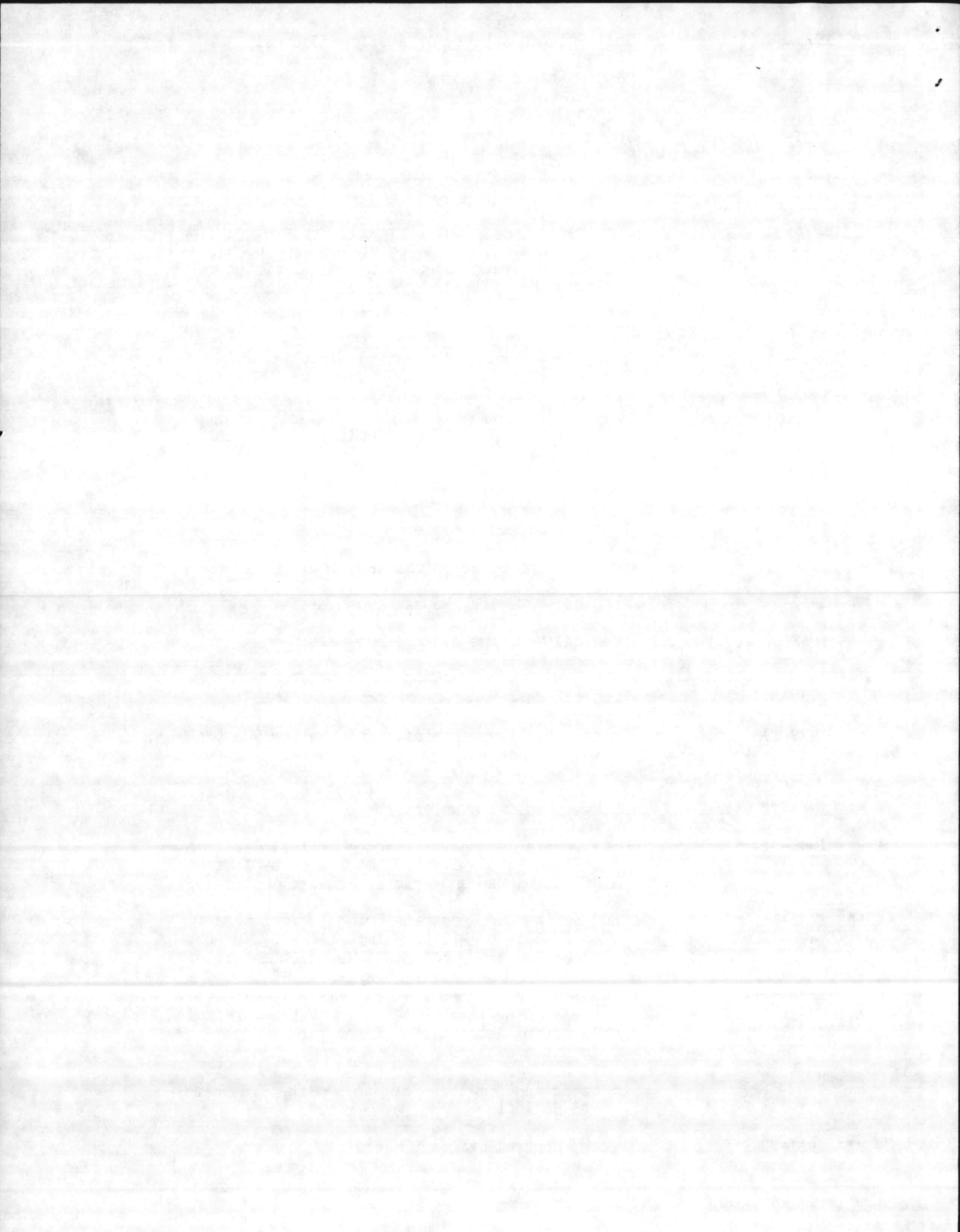

+ **	1960-66 (*)	Velsicol Chemical Co. - Abstracts of Chlordane Endrin - Heptachlor Literature and News Releases
+ **	1975-78	Vigilancia Epidemiologia (Changed to Epidemiological Surveillance)
	1985-	VS News
**	1983-85	Weeds Today
	1984-	Weeds, Trees and Turf
+	1983-	Wildlife Monographs
	1983-	Wildlife Society Bulletin
+ **	1980-82	World of Agricultural Aviation
	1960-66 (*) 1967-	WHO Bulletin
	1952- (*)	WHO Chronicle
	1950- (*)	WHO Technical Report Series
	1964- (*)	WHO Weekly Epidemiological Record (Complete 3 yrs. - prior uncoded issues discarded)
+ **	1963- (*)	WHO Weekly Epidemiological Report (Complete 3 yrs. - prior uncoded issues discarded)
**	1965-82 (*)	WHO World Health Statistics Quarterly (Complete 3 yrs. - prior uncoded issues discarded)
**	1981	World Health Forum
	1987-	World Status Map (Current State Department Traveler Advisories, Warnings, and Wire Reports)

Additional Irregular (unpublished documents) WHO Publications:

+ **	1962 [1] 1963-66 (*)	WHO/EBL
+	1966-77 (*) 1979- (*)	WHO/FIL
+ **	1968-76 (*)	WHO/IRG
+ **	1956-68 (*)	WHO Information Circulars (Insecticide Resistance, Insect Behavior, Vector Genetics, Toxicity of Pesticides to Man, and Vector Control)
+ **	1958-62 (*)	WHO Insecticides
+ **	1967-79 (*)	WHO/LEISH
+	1961- (*)	WHO/MAL

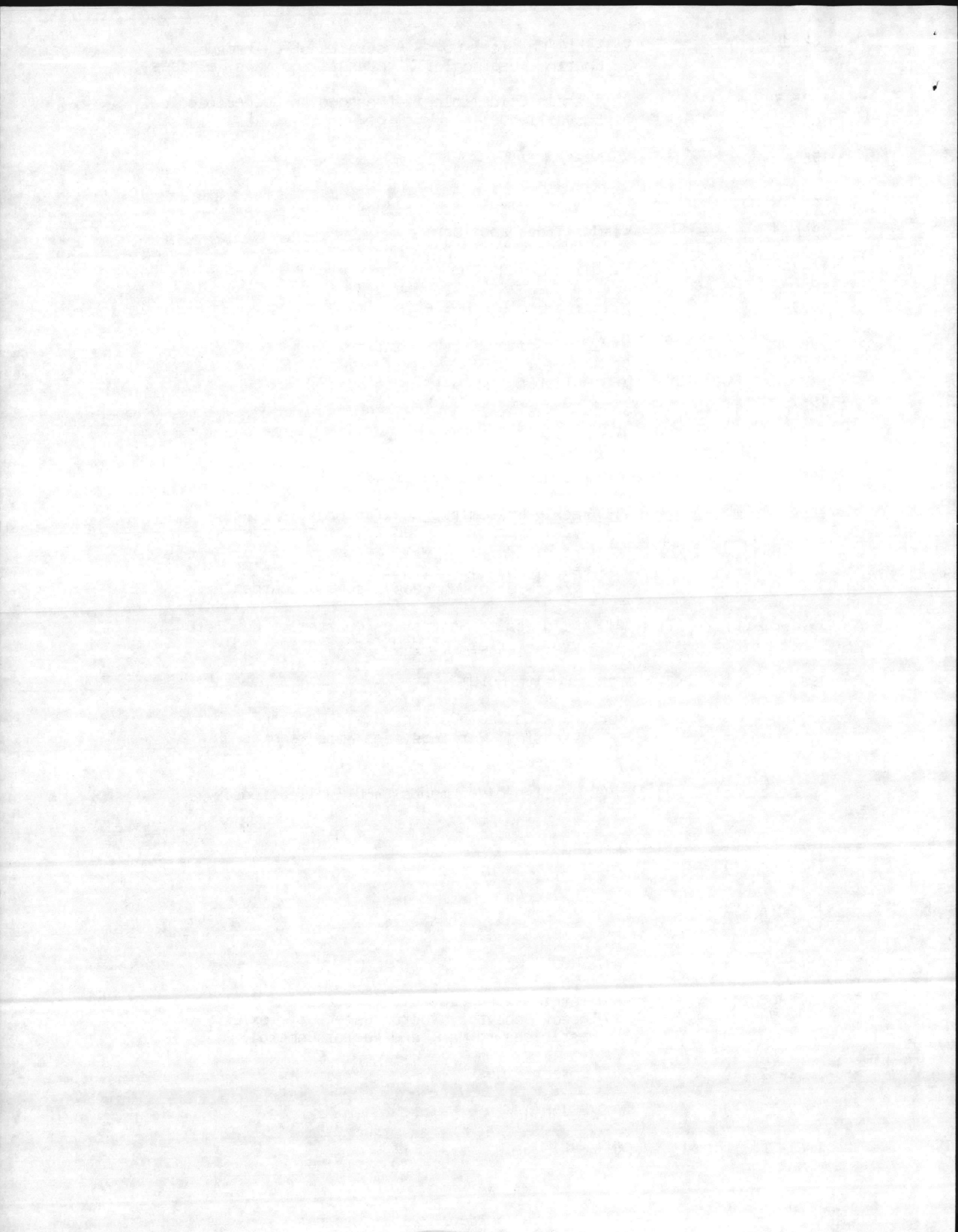



Additional Irregular (unpublished documents) WHO Publications:  
(Continued)

+ **	1966-85 (*)	WHO/ONCHO
+	1968- (*)	WHO/SCHISTO
+ **	1968-78 (*)	WHO/TOX
+	1970-76 (*) 1978- (*)	WHO/VBC
+ **	1962-69 (*)	WHO Vector Control

NOTE: 229 = Total Number of periodicals

128 = Periodicals currently received and selectively coded



10/1

Glenn's Don  
Find out what  
this project  
is about  
At your convenience  
Call MAJOR GRAY  
at IVC

DEPARTMENT OF THE NAVY  
NAVAL HOSPITAL  
CAMP LEJEUNE, NORTH CAROLINA 28542-5008



IN REPLY REFER TO

6260.3g/  
87-264-3g  
371  
15 Jul 87

Commanding Officer  
General, Marine Corps Base, Camp Lejeune, North Carolina  
NAVFAC (ASST) (AC/S Facilities Department)  
PROPOSED PEST CONTROL FACILITY, MARINE CORPS AIR STATION

- Ref:
- (a) Phoncon btwn Mr. Bastob (OH and PMD) and Mr. Werner (Public Works Division) of 7 Jul 87
  - (b) Project 87-9311 Construct Pest Control Facility MCAS
  - (c) Military Handbook 1028/8 Pest Control Facilities 31 Oct 1984
  - (d) CO, NHCLNC ltr 6260.3M.1 371 dtd 4 Aug 86
  - (e) NAVFAC DM-1 Architecture, Chapter 1, Section 4 and Chapter 2, Section 2, paragraph 6
  - (f) 40 CFR 165 (Latest Updated Version)
  - (g) NAVFAC DM-1 Architecture, Chapter 2, Section 4, Part 4, and Chapter 3, Section 2, Part 4
  - (h) AFPMB Manual - Technical Information Manual #15
  - (i) 29 CFR 1910.106
  - (j) Technical Information Memorandum No. 17 Pest Control Facilities from Armed Forces Pest Management Board
  - (k) OPNAVINST 6250.4
  - (l) NAVMED P-5010-8
  - (m) NAVFAC DM 28.8
  - (n) 29 CFR 1910.141
  - (o) OPNAVINST 5090.1

1. In response to reference (a), a meeting was held with Mr. Werner on 7 July 1987 to discuss the appropriate references and occupational health standards/guidelines which should be incorporated into the design specifications for reference (b). References (c) through (o) need to be reviewed to make sure that the Pest Control Facility is properly designed and that the proper standards/guidelines are included.

2. The following specific points need to be considered to make sure the design of the Pest Control Facility is proper:

a. Per paragraph 3.7 b. of reference (c), a fixed temperature/rate of rise heat actuated device (HAD) detection system must be installed in the facility and be connected to the Fire Department.

b. Public Works Division needs to check with Insect Vector Control (IVC) as to whether the people at MCAS will be washing/drying their coveralls etc. using the proposed washer and dryer. If other arrangements are being made to clean protective clothing, delete the units.

Don





*JW* *D* *RS*

DEPARTMENT OF THE NAVY  
NAVAL HOSPITAL  
CAMP LEJEUNE, NORTH CAROLINA 28542-5008



IN REPLY REFER TO

6260.3g/  
87-264-3g  
371  
15 Jul 87

From: Commanding Officer  
To: Commanding General, Marine Corps Base, Camp Lejeune, North Carolina  
28542 (Attn: AC/S Facilities Department)

Subj: REVIEW OF PROPOSED PEST CONTROL FACILITY, MARINE CORPS AIR STATION  
PROJECT 87-9311

Ref: (a) Phoncon btwn Mr. Bastob (OH and PMD) and Mr. Werner (Public Works  
Division) of 7 Jul 87  
(b) Project 87-9311 Construct Pest Control Facility MCAS  
(c) Military Handbook 1028/8 Pest Control Facilities 31 Oct 1984  
(d) CO, NHCLNC ltr 6260.3M.1 371 dtd 4 Aug 86  
(e) NAVFAC DM-1 Architecture, Chapter 1, Section 4 and Chapter 2,  
Section 2, paragraph 6  
(f) 40 CFR 165 (Latest Updated Version)  
(g) NAVFAC DM-1 Architecture, Chapter 2, Section 4, Part 4, and Chapter  
3, Section 2, Part 4  
(h) AFPMB Manual - Technical Information Manual #15  
(i) 29 CFR 1910.106  
(j) Technical Information Memorandum No. 17 Pest Control Facilities  
from Armed Forces Pest Management Board  
(k) OPNAVINST 6250.4  
(l) NAVMED P-5010-8  
(m) NAVFAC DM 28.8  
(n) 29 CFR 1910.141  
(o) OPNAVINST 5090.1

1. In response to reference (a), a meeting was held with Mr. Werner on 7 July 1987 to discuss the appropriate references and occupational health standards/guidelines which should be incorporated into the design specifications for reference (b). References (c) through (o) need to be reviewed to make sure that the Pest Control Facility is properly designed and that the proper standards/guidelines are included.

2. The following specific points need to be considered to make sure the design of the Pest Control Facility is proper:

a. Per paragraph 3.7 b. of reference (c), a fixed temperature/rate of rise heat actuated device (HAD) detection system must be installed in the facility and be connected to the Fire Department.

b. Public Works Division needs to check with Insect Vector Control (IVC) as to whether the people at MCAS will be washing/drying their coveralls etc. using the proposed washer and dryer. If other arrangements are being made to clean protective clothing, delete the units.

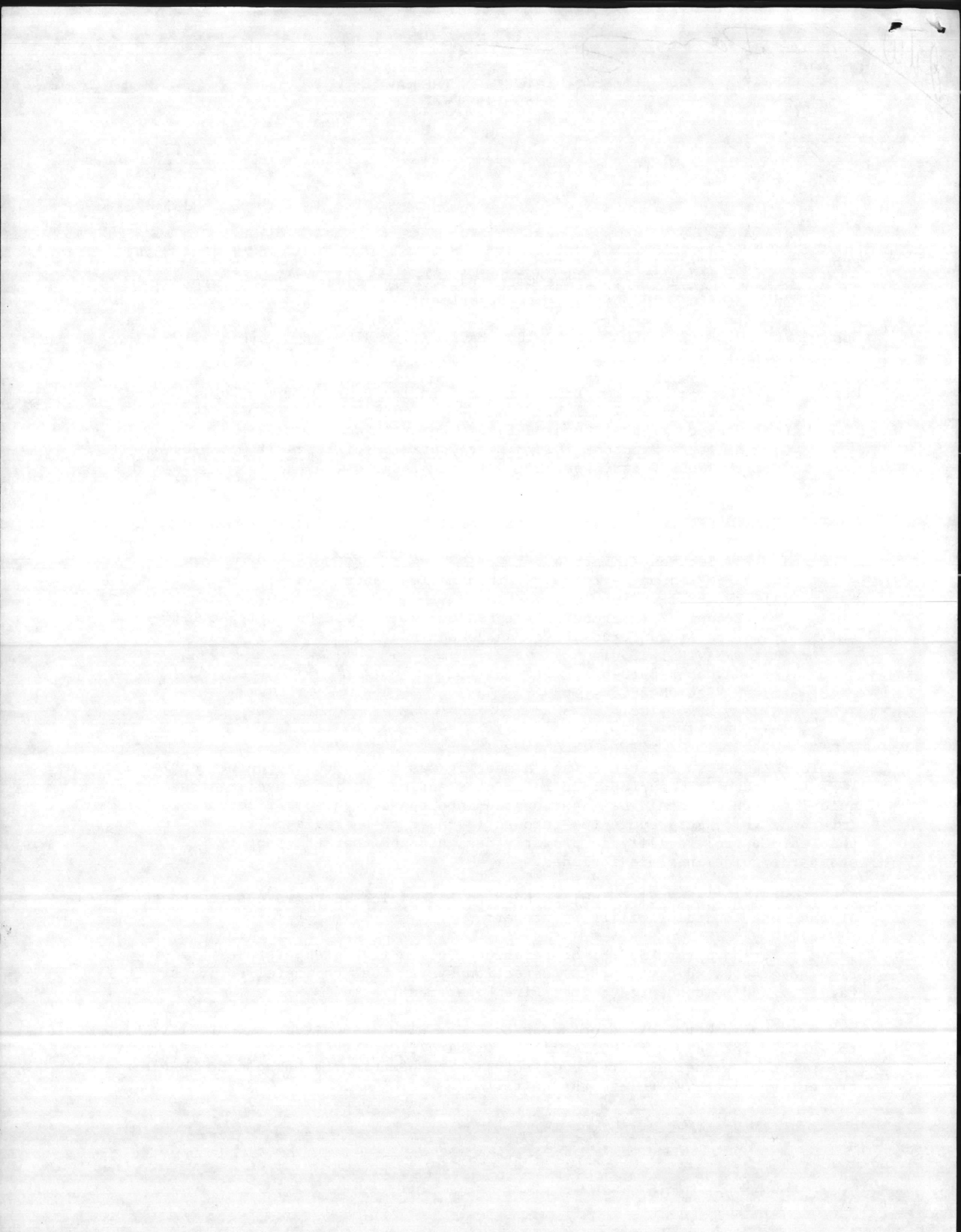



Subj: REVIEW OF PROPOSED PEST CONTROL FACILITY, MARINE CORPS  
AIR STATION PROJECT 87-9311

c. In each mixing and storage room there needs to be a 4 inch drop slope from all sides to the drain per reference (c). The feasibility of including an additional raised sill for the entrances into the mixing room and the vehicle storage/equipment storage area should also be considered.

d. Each separate mixing room, storage room/area must have its own emergency eye wash and deluge shower which meet the requirements in reference (c).

e. Each exhaust ventilation system in the mixing/storage rooms/areas must meet EPA standards.

f. Insect Vector Control needs to be contacted by Public Works Division to determine if herbicides will be stored in the MCAS facility. If so, a separate herbicide storage room must be included in the design and the requirements of reference (c) must be met.

g. The Public Works Division needs to provide complete written documentation to the Industrial Hygiene Branch, Occupational Health and Preventive Medicine Department, that all siting requirements of paragraph 3.4.b. of reference (c) are being met.

h. Public Works Division needs to consult with IVC as to whether they desire an outdoor formulation/mixing and washdown area and if they do, it must be designed per reference (c).

3. During the project design process, IVC, Industrial Hygiene Branch, Natural Resources and Environmental Division, Base Entomologist, Base Safety, and Base Fire Department need to review the blueprints/specifications. Occupational Health (Industrial Hygiene) and safety review is mandated by OPNAVINST 5100.23B.

4. Point of contact on this subject for the Industrial Hygiene Branch, Occupational Health and Preventive Medicine Department are either Ms. I. Sanchez (Industrial Hygienist) at extension 6813 or Mr. Robert Bastob (Industrial Hygienist) at extension 2707.

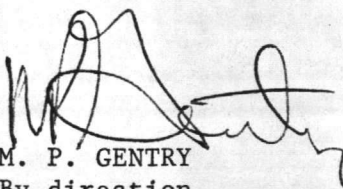
  
M. P. GENTRY  
By direction

Copy to:  
CO, MCAS  
Public Works Officer  
IVC  
Base Safety  
Base Entomologist  
Base Fire Dept.  
Natural Resources and  
Environmental Div.

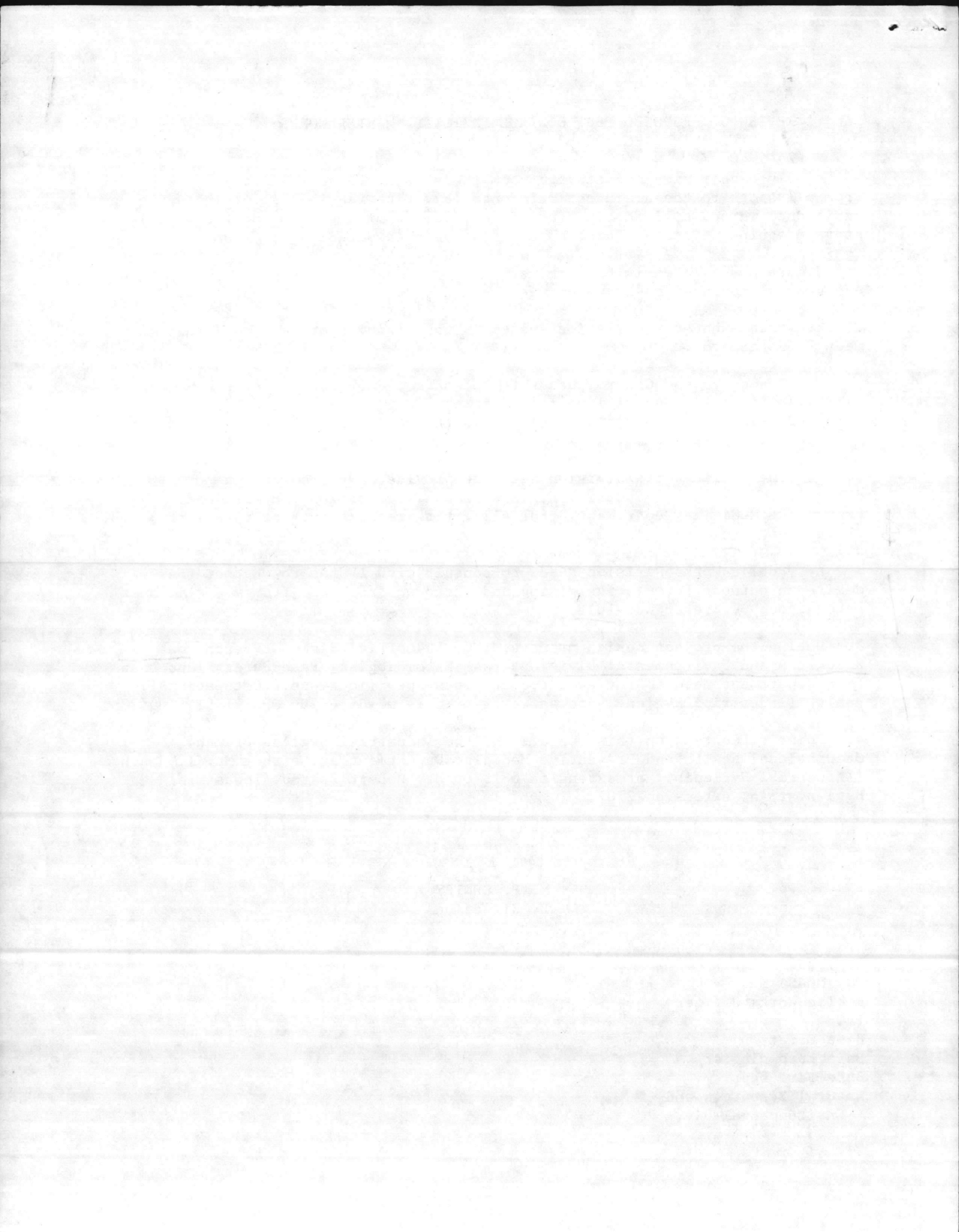



PEST MANAGEMENT REPORT											C.D. CODE UIC			REPORT CONTROL SYMBOL					
NAME OF MAJOR OR REVIEWING COMMAND COMMANDER ATLANTIC DIV (10-A) NAVAL FACILITIES ENGINEERING GMD											ADDRESS NORFOLK, VA 23511			NAME OF REPORTING INSTALLATION MARINE CORPS BASE			ADDRESS CAMP LEJEUNE, NC 28542		
NO.	TARGET PEST		OPERATION			PESTICIDE							TIME						
	NAME (a)	NAME (b)	TOTAL UNITS TREATED (c)	UNIT (d)	SITE (e)	NAME (f)	FORM (g)	APPLICATION		FINAL CONC. % (j)	RATE (PER AREA UNIT)		SUPPLY SOURCE ENTER S, N, G, C (m)	HOURS (n)					
								AMOUNT (h)	UNIT (i)		LBS. (k)	% (l)							
	13-15	17-19	20-24	25-27	28-30	31-33	34-36	37-41	42-43	44-49	50-55	56-58	68	69-71					
1.	WOB	SPCTR	25	MCF	RES	PYRETHRUM	SLN	2	ZGL	.04			S	2					
2.	WOB	EXRESIDTR	3	MCF	OFF	PYRETHRUM	AER	36	FLO	.05			N	4					
3.	WOB	EXRESIDTR	16	MSF	RES	PYRETHRUM	AER	64	FLO	.05			N	1					
4.	SUBTERMS	ENGDINSSUR			HOL									3					
5.	SUBTERMS	ENGDINSSUR			IND									2					
6.	SUBTERMS	ENGDINSSUR			RCH									2					
7.	WOB	ENGDINSSUR			RES									1					
8.	MOSQUITOES	MEDDINSSUR												4					
9.	SUBTERMS	ENGDINSSUR			WHS									21					
10.	SUBTERMS	ENGDINSSUR			RES									37					
11.	SUBTERMS	TRNSOILTR	6121	MCF	RES	CHLORDANE	EML	2745	ZGL	1			S	173					
12.	SUBTERMS	TRNSOILTR	24	MCF	OFF	CHLORDANE	EML	30	ZGL	1			S	4					
13.	SUBTERMS	SURSOILTR	10	MCF	BRQ	CHLORDANE	EML	15	ZGL	1			S	2					
14.	SUBTERMS	INJECTSOIL	24	MCF	BRQ	CHLORDANE	EML	30	ZGL	1			S	4					
15.	SUBTERMS	INJECTSOIL	38	MCF	RCH	CHLORDANE	EML	35	ZGL	1			S	6					
16.	SUBTERMS	INJECTSOIL	16	MCF	OFF	CHLORDANE	EML	25	ZGL	1			S	3					
17.	FILTHFLIES	STEAMCLEAN	30	EA	TRC									74					
18.	SUBTERMS	INJECTSOIL	5386	MCF	RES	CHLORDANE	EML	2221	ZGL	1			S	94					
19.	SUBTERMS	INJECTSOIL	24	MCF	RCH	CHLORDANE	EML	50	ZGL	1			S	3					

NO.	TARGET PEST	OPERATION				PESTICIDE							TIME	
	NAME (a)	NAME (b)	TOTAL UNITS TREATED (c)	UNIT (d)	SITE (e)	NAME (f)	FORM (g)	APPLICATION		FINAL CONC. (j)	RATE (PER AREA UNIT)		SUPPLY SOURCE	HOURS (n)
								AMOUNT (h)	UNIT (i)		LBS. (k)	% (l)	ENTER S, N, G, C (m)	
13-15	17-19	20-24	25-27	28-30	31-33	34-36	37-41	42-43	44-49	50-55	56-58	68	69-71	
20.	FLEAS	RESIDTR	18	MSF	RES	FICAM	SUS	3	ZGL	.5			N	4
21.	FIREANTS	ENGDINSSUR	2	AC	OPG									2
22.	FIREANTS	SPPDEQ	8	AC	OPG	DURSBAN	EML	91	ZGL	.01			N	9
23.	FIREANTS	DGHAND	241	AC	OPG	OSY (AMDRO)	BTS	34	PDW	.88			N	178
24.	ANTS	RESIDTR	1	MSF	WHS	DURSBAN	EML	1	ZGL	.01			N	2
25.	ANTS	EXRESIDTR	2	MSF	OFF	DIAZINON	EML	1	ZGL	1			S	1
26.	MOLES	DGHAND	2	AC	OPG	DURSBAN	GRN	1	PDW	.5			N	4
27.	BDLVDWEED	SPPDEQ	55	AC	OPG	OPH (TREXSAN)	EML	1100	ZGL	2.6			N	23
28.	BDLVDWEED	SPPDEQ	80	AC	OPG	2 4 D	EML	1600	ZGL	1			N	28
29.	MICE	INBAIT	14	MSF	FHB	TALON	BTS	2	PDW	.005			N	1
30.	RATS	INBAIT	12	MSF	EXC	TALON	BTS	2	PDW	.005			N	1

## REMARKS

## INSTRUCTIONS FOR USE

- Detailed instructions of the implementing department directive shall be used in the preparation of this report.
- Military installations shall prepare this report by the 15th day after the end of each month. The report shall be prepared and signed by the DOD certified pest management supervisor, applicator or inspector and by the installation engineer.
- Three copies shall be signed and distributed as follows:
  - Copy No. 1. To the appropriate pest management professional in accordance with implementing department directives for technical review.
  - Copy No. 2. Record to the installation surgeon.
  - Copy No. 3. Record copy to the installations engineer for two year retention in accordance with Public Law 92-516.

INSTALLATION ENGINEER  
(Reviewing Officer)

SIGNATURE

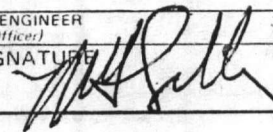
TYPED NAME  
M. G. LILLEY, COL

DATE (yy/mm/dd)

8/24/87

BASE MAINTENANCE OFFICER

INSTALLATION CERTIFIED PEST MANAGEMENT SUPERVISOR,  
APPLICATOR, OR INSPECTOR

SIGNATURE

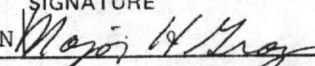
TYPED NAME  
MAJOR H. GRAY  
PEST CONTROL FOREMAN

DATE (yy/mm/dd)

870821

## PEST MANAGEMENT REPORT

C.D. CODE	UIC	REPORT CONTROL SYMBOL
0 2 5 3 M 4 6 5 7 6 0 7 0 8 1 9 8 10 10 12 3		DD-M(A&AR) 1080

NAME OF MAJOR OR REVIEWING COMMAND COMMANDER ATLANTIC DIV. (10-A) NAVAL FACILITIES ENGINEERING CMD	ADDRESS NORFOLK, VA 23511	NAME OF REPORTING INSTALLATION MARINE CORPS BASE	ADDRESS CAMP LEJEUNE, NC 28542
--	------------------------------	---	-----------------------------------

NO.	TARGET PEST	OPERATION			PESTICIDE							TIME		
	NAME (a)	NAME (b)	TOTAL UNITS TREATED (c)	UNIT (d)	SITE (e)	NAME (f)	FORM (g)	APPLICATION		FINAL CONC. (j)	RATE (PER AREA UNIT)		SUPPLY SOURCE ENTER S, N, G, C (m)	HOURS (n)
								AMOUNT (h)	UNIT (i)		LBS. (k)	% (l)		
	13-15	17-19	20-24	25-27	28-30	31-33	34-36	37-41	42-43	44-49	50-55	56-58	68	69-71
1.	ROD GRUBBS	SPPDEQ	1	AC	OPG	DURSBAN	EML	40	ZGL	.01			N	3
2.	ROACHES	ENGDINSSUR			BRQ									2
3.	ROACHES	ENGDINSSUR			OFF									1
4.	ROACHES	ENGDINSSUR			RES									52
5.	ROACHES	ENGDINSSUR			EXC									3
6.	ROACHES	ENGDINSSUR			FHB									3
7.	ROACHES	RESIDTR	10	MSF	BRG	PYRETHRUM	AER	32	FLO	.25			N	2
8.	ROACHES	RESIDTR	117	MSF	EXC	D-PHENOTHRIN	AER	154	FLO	2			S	11
9.	ROACHES	RESIDTR	34	MSF	FHB	PYRETHRUM	AER	144	FLO	.25			N	10
10.	ROACHES	ENGDINSSUR			HOL									1
11.	ROACHES	RESIDTR	11	MSF	OFF	PYRETHRUM	AER	96	FLO	.25			N	4
12.	ROACHES	ENGDINSSUR			IND									1
13.	ROACHES	RESIDTR	89	MSF	RES	PYRETHRUM	AER	68	FLO	.25			N	3
14.	ROACHES	ENGDINSSUR			OFF									2
15.	ROACHES	RESIDTR	3	MSF	WHS	PYRETHRUM	AER	20	FLO	.25			N	1
16.	ROACHES	RESIDTR	1	MSF	WHS	D-PHENOTHRIN	AER	6	FLO	2			S	1
17.	ROACHES	RESIDTR	111	MSF	RCH	D-PHENOTHRIN	AER	45	FLO	2			S	56
18.	ROACHES	RESIDTR	1	MSF	IND	D-PHENOTHRIN	AER	3	FLO	2			S	1
19.	ROACHES	SPCTR	602	MSF	RES	D-PHENOTHRIN	AER	454	FLO	2			S	20

NO.	TARGET PEST		OPERATION			PESTICIDE							TIME	
	NAME (a)	NAME (b)	TOTAL UNITS TREATED (c)	UNIT (d)	SITE (e)	NAME (f)	FORM (g)	APPLICATION		FINAL CONC. (j)	RATE (PER AREA UNIT)		SUPPLY SOURCE ENTER S, N, G, C (m)	HOURS (n)
								AMOUNT (h)	UNIT (i)		LBS. (k)	% (l)		
	13-15	17-19	20-24	25-27	28-30	31-33	34-36	37-41	42-43	44-49	50-55	56-58	68	69-71
20.	ROACHES	SPCTR	162	MCF	FHB	D-PHENOTHRIN	AER	324	FLO	2			S	24
21.	ROACHES	ENGDISSUR			RCH									3
22.	ROACHES	SELF-HELP												11
23.	ROACHES	RESIDTR	49	MSF	RES	PYRETHRUM	DUS	5	PDW	1			C	18
24.	ROACHES	RESIDTR	31	MSF	RES	DIAZINON	DUS	16	PDW	1			C	7
25.	ROACHES	RESIDTR	26	MSF	RES	DIAZINON	DUS	12	PDW	2			C	5
26.	ROACHES	RESIDTR	128	MSF	RES	DURSBAN	EML	61	ZGL	.5			C	68
27.	ROACHES	RESIDTR	5	MSF	RES	PYRETHRUM	DUS	1	PDW	.9			N	2
28.	ROACHES	RESIDTR	112	MSF	RES	DIAZINON	EML	65	ZGL	1			S	54
29.	ROACHES	RESIDTR	18	MSF	BRG	DIAZINON	EML	5	ZGL	1			S	5
30.	ROACHES	RESIDTR	33	MSF	OFF	DIAZINON	EML	13	ZGL	1			S	15

## REMARKS

## INSTRUCTIONS FOR USE

- Detailed instructions of the implementing department directive shall be used in the preparation of this report.
- Military installations shall prepare this report by the 15th day after the end of each month. The report shall be prepared and signed by the DOD certified pest management supervisor, applicator or inspector and by the installation engineer.
- Three copies shall be signed and distributed as follows:
  - Copy No. 1. To the appropriate pest management professional in accordance with implementing department directives for technical review.
  - Copy No. 2. Record to the installation surgeon.
  - Copy No. 3. Record copy to the installations engineer for two year retention in accordance with Public Law 92-516.

INSTALLATION ENGINEER  
(Reviewing Officer)

SIGNATURE

TYPED NAME  
M. G. LILLEY, COL  
BASE MAINTENANCE OFFICER

DATE (yyymmdd)

8/24/87

INSTALLATION CERTIFIED PEST MANAGEMENT SUPERVISOR,  
APPLICATOR, OR INSPECTOR

SIGNATURE

TYPED NAME  
MAJOR H. GRAY  
PEST CONTROL FOREMAN

Major H. Gray

DATE (yyymmdd)

870821

## PEST MANAGEMENT REPORT

 CD. CODE UIC  
 0 2 5 3 M 4 6 5 7 6 0 7 0 8 1 9 8 10 7 10 12 3  
 REPORT CONTROL SYMBOL  
 DD-M(A&R) 1000

 NAME OF MAJOR OR REVIEWING COMMAND  
 COMMANDER, ATLANTIC DIV. (10-A)  
 NAVAL FACILITIES ENGINEERING CMD  
 ADDRESS  
 NORFOLK, VA 23511

 NAME OF REPORTING INSTALLATION  
 MARINE CORPS BASE  
 ADDRESS  
 CAMP LEJEUNE, NC 28542

NO.	TARGET PEST NAME (a)	OPERATION			PESTICIDE								TIME HOURS (n)	
		NAME (b)	TOTAL UNITS TREATED (c)	UNIT (d)	SITE (e)	NAME (f)	FORM (g)	APPLICATION		FINAL CONC. (j)	RATE (PER AREA UNIT)			SUPPLY SOURCE ENTER S, N, G, C (m)
								AMOUNT (h)	UNIT (i)		LBS. (k)	% (l)		
13-15		17-19	20-24	25-27	28-30	31-33	34-36	37-41	42-43	44-49	50-55	56-58	60	69-71
1.	ROACHES	RESIDTR	14	MSF	UTL	DIAZINON	EML	2	ZGL	1			S	3
2.	ROACHES	RESIDTR	10	MSF	FHB	DIAZINON	EML	2	ZGL	1			S	2
3.	ROACHES	RESIDTR	32	MSF	WHS	DIAZINON	EML	12	ZGL	1			S	21
4.	ROACHES	RESIDTR	6	MSF	BRQ	D-PHENOTHRIN	AER	26	FLO	2			S	3
5.	ROACHES	RESIDTR	102	MSF	BRQ	DIAZINON	EML	17	ZGL	1			S	33
6.	ROACHES	RESIDTR	5	MSF	EXC	DIAZINON	EML	4	ZGL	1			S	5
7.	ROACHES	RESIDTR	129	MSF	RCH	DIAZINON	EML	32	ZGL	1			S	31
8.	ROACHES	RESIDTR	22	MSF	IND	DIAZINON	EML	4	ZGL	1			S	8
9.	ROACHES	RESIDTR	1	MSF	OFF	D-PHENOTHRIN	AER	8	FLO	2			S	1
10.	ROACHES	RESIDTR	4	MSF	WHS	DURSBAN	SLN	1	ZGL	2			N	1
11.	ROACHES	RESIDTR	111	MSF	RES	DURSBAN	EML	45	ZGL	.5			N	56
12.	ROACHES	RESIDTR	70	MSF	WHS	DURSBAN	EML	17	ZGL	.5			N	30
13.	ROACHES	RESIDTR	40	MSF	RCH	DURSBAN	EML	2	ZGL	1			N	2
14.	ROACHES	RESIDTR	20	MSF	RCH	DURSBAN	EML	5	ZGL	.5			N	2
15.	ROACHES	RESIDTR	4	MSF	OFF	DURSBAN	EML	1	ZGL	.5			N	2
16.	ROACHES	TRAP (GLUE)	11	MSF	FHB									3
17.	ROACHES	RESIDTR	2	MSF	EXC		EML	1	ZGL	.5			N	1
18.	ROACHES	RESIDTR	158	MSF	EXC	OSY COMBAT	BTS	3	PDW	1.65			S	24
19.	ROACHES	INBAIT	1	MSF	HOL	OSY COMBAT	BTS	1	PDW	1.65			S	1

NO.	TARGET PEST	OPERATION				PESTICIDE							TIME	
	NAME (a) 13-15	NAME (b) 17-19	TOTAL UNITS TREATED (c) 20-24	UNIT (d) 25-27	SITE (e) 28-30	NAME (f) 31-33	FORM (g) 34-36	APPLICATION		FINAL CONC. % (j) 44-49	RATE (PER AREA UNIT)		SUPPLY SOURCE	HOURS (n) 69-71
								AMOUNT (h) 37-41	UNIT (i) 42-43		LBS. (k) 50-55	% (l) 56-58	ENTER S, N, G, C (m) 68	
20.	ROACHES	INBAIT	52	MSF	RCH	OSY COMBAT	BTS	4	PDW	1.65			S	25
21.	ROACHES	INBAIT	47	MSF	OFF	OSY COMBAT	BTS	3	PDW	1.65			S	20
22.	ROACHES	INBAIT	40	MSF	FHB	OSY COMBAT	BTS	5	PDW	1.65			S	31
23.	ROACHES	INBAIT (GLUE)	4	MSF	FHB									2
24.	ROACHES	INTRAP (GLUE)	1	MSF	RCH									1
25.		TRAINING												240
26.		MAINTENANCE												96
27.		PROGRAMMING												222
28.		NONPROGRAM												311
29.	EARWIGS	SPPDEQ	2	AC	OPG	DURSBAN	EML	30	ZGL	.01			N	3
30.														

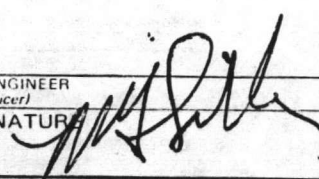
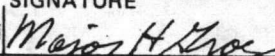
REMARKS				INSTRUCTIONS FOR USE			
				<p>1. Detailed instructions of the implementing department directive shall be used in the preparation of this report.</p> <p>2. Military installations shall prepare this report by the 15th day after the end of each month. The report shall be prepared and signed by the DOD certified pest management supervisor, applicator or inspector and by the installation engineer.</p> <p>3. Three copies shall be signed and distributed as follows:</p> <p>a. <i>Copy No. 1.</i> To the appropriate pest management professional in accordance with implementing department directives for technical review.</p> <p>b. <i>Copy No. 2.</i> Record to the installation surgeon.</p> <p>c. <i>Copy No. 3.</i> Record copy to the installations engineer for two year retention in accordance with Public Law 92-516.</p>			
				INSTALLATION ENGINEER <i>(Reviewing Officer)</i> TYPED NAME M. G. LILLEY, COL BASE MAINTENANCE, OFFICER			
SIGNATURE 				SIGNATURE 			
DATE (yyymmdd) 8/24/87				DATE (yyymmdd) 870821			

## PEST MANAGEMENT REPORT

 C.D. CODE UIC  
 0 2 5 3 M 4 6 5 7 6 0 7 0 8 1 9 8 10 11 12 6  
 REPORT CONTROL SYMBOL  
 DD-M(AS&R) 1080

 NAME OF MAJOR OR REVIEWING COMMAND ADDRESS NAME OF REPORTING INSTALLATION ADDRESS  
 COMMANDER, ATLANTIC DIV (10-A) NORFOLK, VA 23511 MARINE CORPS BASE CAMP LEJEUNE, NC 28542  
 NAVAL FACILITIES ENGINEERING CMD

NO	TARGET PEST		OPERATION			PESTICIDE							TIME	
	NAME (a)	NAME (b)	TOTAL UNITS TREATED (c)	UNIT (d)	SITE (e)	NAME (f)	FORM (g)	APPLICATION		FINAL CONC. (j)	RATE (PER AREA UNIT)		SUPPLY SOURCE ENTER S, N, G, C (m)	HOURS (n)
								AMOUNT (h)	UNIT (i)		LBS. (k)	% (l)		
	13-15	17-19	20-24	25-27	28-30	31-33	34-36	37-41	42-43	44-49	50-55	56-58	68	69-71
1.	MOSQUITOES	FOGGING	87	AC	OPG	MALATHION	SLN	4	ZGL	95			S	7
2.	MOSQUITOES	FOGGING	320	AC	WOO	MALATHION	SLN	10	ZGL	95			S	3
3.	MOSQUITOES	ENGDISSUR			IMP									2
4.	MOSQUITOES	MISTING	40	AC	WOO	MALATHION	EML	200	ZGL	1			S	8
5.	TICKS	SPPDEQ	21	AC	OPG	DURSBAN	EML	563	ZGL	.01			N	32
6.	TICKS	RESIDTR	6	MSF	OFF	DURSBAN	EML	2	ZGL	.01			N	2
7.	TICKS	MISTING	50	AC	OPG	MALATHION	EML	1000	ZGL	1			S	31
8.	TICKS	SPPDEQ	10	MSF	OPG	MALATHION	EML	200	ZGL	1			S	16
9.	WOB	SPCTR	2	MCF	OFF	PYRETHRUM	AER	12	FLO	.05			N	1
10.	WOB	SPCTR	16	MSF	OPG	PYRETHRUM	AER	64	FLO	.05			N	23
11.	WOB	SPCTR	18	MSF	RES	PYRETHRUM	AER	212	FLO	.05			N	7
12.	WOB	SPCTR	6	MCF	HOL	PYRETHRUM	AER	16	FLO	.05			N	1
13.	WOB	SPCTR	2	MCF	WHS	PYRETHRUM	AER	24	FLO	.05			N	1
14.	WOB	EXRESIDTR	4	MSF	RCH	PYRETHRUM	AER	156	FLO	.05			N	6
15.	WOB	ENGDISSUR			OPG									3
16.	WOB	ENGDISSUR			WHS									2
17.	WOB	ENGDISSUR			RES									1
18.	MOSQUITOES	MEDDISSUR												110
19.	SUBTERMS	ENGDISSUR			EXC									2

NO	TARGET PEST		OPERATION			PESTICIDE							TIME	
	NAME (a)	NAME (b)	TOTAL UNITS TREATED (c)	UNIT (d)	SITE (e)	NAME (f)	FORM (g)	APPLICATION		FINAL CONC. (j)	RATE (PER AREA UNIT)		SUPPLY SOURCE	HOURS (n)
								AMOUNT (h)	UNIT (i)		LBS (k)	% (l)	ENTER S, N, G, C (m)	
	13-15	17-19	20-24	25-27	28-30	31-33	34-36	37-41	42-43	44-49	50-55	56-58	68	69-71
20.	ANTS	RESIDTR	26	MSF	IND	DURSBAN	EML	6	ZGL	.5			N	7
21.	ANTS	RESIDTR	4	MSF	OFF	DIAZINON	EML	3	ZGL	1			S	5
22.	ANTS	SPPDEQ	1	AC	OPG	DIAZINON	EML	2	ZGL	1			S	1
23.	BIRDS	ENGDINSSUR			RES									1
24.	BIRDS	ENGDINSSUR			RCH									6
25.	BIRDS	ENGDINSSUR			IND									3
26.	FOODPEST	SPCTR	1152	MCF	WHS	DCHLORVOS	SLN	110	ZGL	5.62			N	28
27.	FOODPEST	ENGDINSSUR			WHS									2
28.	FOODPEST	RESIDTR	4	MSF	WHS	MALATHION	EML	2	ZGL	3			S	2
29.	EARWIGS	SPPDEQ	1	AC	OPG	DURSBAN	EML	40	ZGL	.01			N	4
30.	SNAKE	ENGDINSSUR			BRQ									3

## REMARKS

## INSTRUCTIONS FOR USE

- Detailed instructions of the implementing department directive shall be used in the preparation of this report.
- Military installations shall prepare this report by the 15th day after the end of each month. The report shall be prepared and signed by the DOD certified pest management supervisor, applicator or inspector and by the installation engineer.
- Three copies shall be signed and distributed as follows:
  - Copy No. 1. To the appropriate pest management professional in accordance with implementing department directives for technical review.
  - Copy No. 2. Record to the installation surgeon.
  - Copy No. 3. Record copy to the installations engineer for two year retention in accordance with Public Law 92-516.

INSTALLATION ENGINEER  
(Reviewing Officer)TYPED NAME  
M. G. KILLEY, COL  
BASE MAINTENANCE OFFICER

SIGNATURE

DATE (yyymmdd)

10/29/57

INSTALLATION CERTIFIED PEST MANAGEMENT SUPERVISOR,  
APPLICATOR, OR INSPECTORTYPED NAME  
MAJOR H. GRAY  
PEST CONTROL FOREMAN

SIGNATURE

DATE (yyymmdd)

871021



## PEST MANAGEMENT REPORT

 CD CODE UIC  
 10 25 3M 46 57 60 7 0 8 1 9 8 107 110 126

 REPORT CONTROL SYMBOL  
 DD-M(A&AR) 1090

 NAME OF MAJOR OR REVIEWING COMMAND ADDRESS NAME OF REPORTING INSTALLATION ADDRESS  
 COMMANDER, ATLANTIC DIV. (10-A) NORFOLK, VA 23511 MARINE CORPS BASE CAMP LEJEUNE, NC 28542  
 NAVAL FACILITIES ENGINEERING CMD

NO	TARGET PEST		OPERATION			PESTICIDE							TIME	
	NAME (a)	NAME (b)	TOTAL UNITS TREATED (c)	UNIT (d)	SITE (e)	NAME (f)	FORM (g)	APPLICATION		FINAL CONC. % (j)	RATE (PER AREA UNIT)		SUPPLY SOURCE ENTER S, N, G, C (m)	HOURS (n)
								AMOUNT (h)	UNIT (i)		LBS. (k)	% (l)		
	13-15	17-19	20-24	25-27	28-30	31-33	34-36	37-41	42-43	44-49	50-55	56-58	60	69-71
1.	FILTHFLIES	SPCTR	63	MCF	RCH	PYRETHRUM	SLN	1	ZGL	3			N	6
2.	FILTHFLIES	SPCTR	24	MCF	RCH	D-PHENOTHRIN	AER	48	FLO	2			S	2
3.	FILTHFLIES	SPCTR	56	MCF	RCH	PYRETHRUM	SLN	2	ZGL	.4			S	5
4.	FLEAS	SPPDEQ	2	AC	OPG	DURSBAN	EML	60	ZGL	.01			N	3
5.	FLEAS	RESIDTR	2	MSF	RES	DIAZINON	EML	1	ZGL	1			N	1
6.	FLEAS	RESIDTR	6	MSF	RES	FICAM	SUS	6	ZGL	.25			N	4
7.	FLEAS	RESIDTR	6	MSF	WHS	DURSBAN	EML	1	ZGL	.5			N	2
8.	FLEAS	RESIDTR	2	MSF	RES	FICAM	SUS	2	ZGL	.5			N	2
9.	FLEAS	RESIDTR	10	MSF	RES	DURSBAN	EML	7	ZGL	.5			N	6
10.	FLEAS	ENGDINSSUR			RES									1
11.	FIREANTS	ENGDINSSUR			OPG									6
12.	FLEAS	RESIDTR	24	MSF	OFF	DURSBAN	EML	6	ZGL	.5			N	4
13.	FLEAS	RESIDTR	24	MSF	RCH	DURSBAN	EML	2	ZGL	.01			N	3
14.	ANTS	SPPDEQ	15	AC	OPG	DURSBAN	EML	311	ZGL	.01			N	23
15.	ANTS	RESIDTR	54	MSF	RCH	DURSBAN	EML	9	ZGL	.5			N	8
16.	ANTS	RESIDTR	4	MSF	OFF	DURSBAN	EML	8	ZGL	.01			N	6
17.	ANTS	RESIDTR	20	MSF	EXC	DURSBAN	EML	5	ZGL	.01			N	4
18.	ANTS	RESIDTR	290	MSF	BRQ	DURSBAN	EML	120	ZGL	.01			N	24
19.	ANTS	DGHAND	2	AC	OPG	OSY (AMDRO)	BTS	2	PDW	.88			N	1

NO	TARGET PEST		OPERATION			PESTICIDE						TIME		
	NAME (a)	NAME (b)	TOTAL UNITS TREATED (c)	UNIT (d)	SITE (e)	NAME (f)	FORM (g)	APPLICATION		FINAL CONC. (j)	RATE (PER AREA UNIT)		SUPPLY SOURCE	HOURS (n)
								AMOUNT (h)	UNIT (i)		LBS (k)	% (l)	ENTER S. N, G, C (m)	
	13-15	17-19	20-24	25-27	28-30	31-33	34-36	37-41	42-43	44-49	50-55	56-58	68	69-71
20.	RATS	INBAIT	2	MSF	FHB	TALON	BTS	1	PDW	.005			N	1
21.	MXGRABDLVD	DGHAND	14	AC	OPG	OBE TREFLAN	GRN	420	PDW	5			N	19
22.	MXGRABDLVD	SPHAND	2	AC	OPG	GLYPHOSATE	EML	4	ZGL	1			N	2
23.	MXGRABDLVD	SPPDEQ	329	AC	OPG	GLYPHOSATE	EML	7476	ZGL	1			N	367
24.	MXGRABDLVD	SPPDEQ	71	AC	OPB	GLYPHOSATE	EML	1170	ZGL	1			N	52
25.	ROACHES	ENGDINSSUR												40
26.	ROACHES	ENGDINSSUR												6
27.	ROACHES	ENGDINSSUR												10
28.	ROACHES	ENGDINSSUR												1
29.	ROACHES	RESIDTR	28	MSF	EXC	D-PHENOTHRIN	AER	73	FLO	2			S	6
30.	MXGRABDLVD	ENGDINSSUR												3

REMARKS

**INSTRUCTIONS FOR USE**

- Detailed instructions of the implementing department directive shall be used in the preparation of this report.
- Military installations shall prepare this report by the 15th day after the end of each month. The report shall be prepared and signed by the DOD certified pest management supervisor, applicator or inspector and by the installation engineer.
- Three copies shall be signed and distributed as follows:
  - Copy No. 1. To the appropriate pest management professional in accordance with implementing department directives for technical review.
  - Copy No. 2. Record to the installation surgeon.
  - Copy No. 3. Record copy to the installations engineer for two year retention in accordance with Public Law 92-516.

INSTALLATION ENGINEER  
(Reviewing Officer)

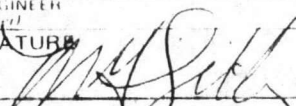
TYPED NAME: M.G. LILLEY, COL  
SIGNATURE:   
BASE MAINTENANCE OFFICER

DATE (yyymmdd): 10/22/87

INSTALLATION CERTIFIED PEST MANAGEMENT SUPERVISOR,  
APPLICATOR, OR INSPECTOR

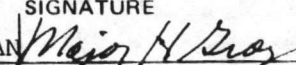
TYPED NAME: MAJOR H. GRAY  
SIGNATURE:   
PEST CONTROL FOREMAN

DATE (yyymmdd): 871021

PEST MANAGEMENT REPORT

C.D. CODE UIC 0 2 5 3 M 4 6 5 7 6 0 7 0 8 1 9 8 10 7 11 0 12 6  
 REPORT CONTROL SYMBOL DD-M(A&AR) 1000

NAME OF MAJOR OR REVIEWING COMMAND ADDRESS NAME OF REPORTING INSTALLATION ADDRESS  
 COMMANDER, ATLANTIC DIV. (10-A) NORFOLK, VA 23511 MARINE CORPS BASE CAMP LEJEUNE, NC 28542  
 NAVAL FACILITIES ENGINEERING CMD

NO	TARGET PEST		OPERATION			PESTICIDE							TIME														
	NAME (a)	NAME (b)	TOTAL UNITS TREATED (c)	UNIT (d)	SITE (e)	NAME (f)	FORM (g)	APPLICATION		FINAL CONC. (j)	RATE (PER AREA UNIT)		SUPPLY SOURCE ENTER S, N, G, C (m)	HOURS (n)													
								AMOUNT (h)	UNIT (i)		LBS. (k)	% (l)															
13-15		17-19		20-24		25-27		28-30		31-33		34-36		37-41		42-43		44-49		50-55		56-58		68		69-71	
1.	WOB	SPCTR	4	MSF	RCH	PYRETHRUM	AER	28	FLO	.05				N	2												
2.	WOB	SPCTR	2	MCF	UTL	PYRETHRUM	AER	20	FLO	.05				N	1												
3.	WOB	SPCTR	3	AC	OPG	PYRETHRUM	AER	124	FLO	.05				N	4												
4.	MICE	ENGDINSSUR			WHS										2												
5.	MICE	ENGDINSSUR			EXC										2												
6.	MICE	INTRAP (GLUE)	4	MSF	OFF										2												
7.	MICE	INTRAP (GLUE)	4	MSF	HOL										1												
8.	MICE	INTRAP	2	MSF	EXC										1												
9.	MICE	INBAIT	2	MSF	WHS	WARFARIN	BTS	1	ZGL	.54				N	2												
10.	MICE	TALON	2	MSF	FHB	TALON	BTS	1	PDW	.005				N	1												
11.	MICE	INBAIT	24	MSF	WHS	TALON	BTS	3	PDW	.005				N	1												
12.	MICE	INBAIT	22	MSF	OFF	TALON	BTS	8	PDW	.005				N	4												
13.	MICE	INBAIT	24	MSF	RCH	TALON	BTS	4	PDW	.005				N	3												
14.	MICE	INBAIT	4	MSF	HOL	TALON	BTS	1	PDW	.005				N	1												
15.	TICKS	ENGDINSSUR			OPG										4												
16.	TURF (DOLLAR SPOT)	SPPDEQ	6	AC	GFG	DACONIL	SUS	600	ZGL	1.5				N	11												
17.	TURF (DOLLAR SPOT)	SPPDEQ	10	AC	GFG	FORE	SUS	200	ZGL	1				N	6												
18.	TURF (DOLLAR SPOT)	SPPDEQ	38	AC	GFG	OBE (TERSAN)	EML	1000	ZGL	1				N	11												
19.	RATS	INBAIT	32	MSF	WHS	TALON	BTS	6	PDW	.005				N	3												

NO	TARGET PEST	OPERATION				PESTICIDE							TIME	
	NAME (a)	NAME (b)	TOTAL UNITS TREATED (c)	UNIT (d)	SITE (e)	NAME (f)	FORM (g)	APPLICATION		FINAL CONC. % (j)	RATE (PER AREA UNIT)		SUPPLY SOURCE ENTER S. N, G, C (m)	HOURS (n)
								AMOUNT (h)	UNIT (i)		LBS. (k)	% (l)		
	13-15	17-19	20-24	25-27	28-30	31-33	34-36	37-41	42-43	44-49	50-55	56-58	68	69-71
20.	GRASSYWEED	SPHAND	2	AC	OPB	OUN (POAST)	EML	8	ZGL	1			N	8
21.	GRASSYWEED	SPHAND	2	AC	OPG	OUN (POAST)	EML	5	ZGL	1			N	3
22.	FIREANTS	RESIDTR	2	MSF	OFF	DIAZINON	EML	2	ZGL	.1			N	2
23.	FIREANTS	RESIDTR	28	MSF	OFF	DURSBAN	EML	20	ZGL	.01			N	3
24.	FIREANTS	EXRESIDTR	2	MSF	RES	DURSBAN	EML	2	ZGL	.01			N	1
25.	FIREANTS	SPPDEQ	45	AC	OPG	DURSBAN	EML	200	ZGL	.01			N	21
26.	FIREANTS	ENGDINSSUR			WHS									2
27.	FIREANTS	SELP-HELP	224	MSF	RES	AMDRO	BTS	5	PDW	.88			N	13
28.	ROACHES	RESIDTR	28	MSF	EXC	DIAZINON	EML	10	ZGL	1			S	11
29.	ROACHES	RESIDTR	46	MSF	BRQ	DIAZINON	EML	22	ZGL	1			S	22
30.	ROACHES	RESIDTR	4	MSF	IND	DIAZINON	EML	1	ZGL	1			S	2

REMARKS

- INSTRUCTIONS FOR USE
- Detailed instructions of the implementing department directive shall be used in the preparation of this report.
  - Military installations shall prepare this report by the 15th day after the end of each month. The report shall be prepared and signed by the DOD certified pest management supervisor, applicator or inspector and by the installation engineer.
  - Three copies shall be signed and distributed as follows:
    - Copy No. 1. To the appropriate pest management professional in accordance with implementing department directives for technical review.
    - Copy No. 2. Record to the installation surgeon.
    - Copy No. 3. Record copy to the installations engineer for two year retention in accordance with Public Law 92-516.

INSTALLATION ENGINEER  
(Reviewing Officer)  
TYPED NAME  
M. G. LILLEY, COL  
BASE MAINTENANCE OFFICER  
SIGNATURE  
*M. G. Lilley*  
DATE (yyymmdd)  
10/22/87

INSTALLATION CERTIFIED PEST MANAGEMENT SUPERVISOR,  
APPLICATOR, OR INSPECTOR  
TYPED NAME  
MAJOR H. GRAY  
PEST CONTROL FOREMAN  
SIGNATURE  
*Major H. Gray*  
DATE (yyymmdd)  
871021

PEST MANAGEMENT REPORT

C.D. CODE UIC 0 2 5 3 M 4 6 5 7 6 0 7 0 8 1 9 8 1 0 1 2 6  
 REPORT CONTROL SYMBOL DD-M(A&AR) 1000

NAME OF MAJOR OR REVIEWING COMMAND  
 COMMANDER, ATLANTIC DIV. (10-A)  
 NAVAL FACILITIES ENGINEERING CMD

ADDRESS  
 NORFOLK, VA 23511

NAME OF REPORTING INSTALLATION  
 MARINE CORPS BASE

ADDRESS  
 CAMP LEJEUNE, NC 28542

NO	TARGET PEST NAME (a)	OPERATION				PESTICIDE							TIME HOURS (n)	
		NAME (b)	TOTAL UNITS TREATED (c)	UNIT (d)	SITE (e)	NAME (f)	FORM (g)	APPLICATION		FINAL CONC. % (j)	RATE (PER AREA UNIT)			SUPPLY SOURCE ENTER S, N, G, C (m)
								AMOUNT (h)	UNIT (i)		LBS. (k)	% (l)		
13-15		17-19	20-24	25-27	28-30	31-33	34-36	37-41	42-43	44-49	50-55	56-58	68	69-71
1.	FILTHFLIES	ENGDINSSUR			RES									4
2.	ROACHES	RESIDTR	82	MSF	OFF	D-PHENOTHRIN	AER	220	FLO	2			S	11
3.	ROACHES	RESIDTR	52	MSF	FHB	D-PHENOTHRIN	AER	620	FLO	2			S	31
4.	ROACHES	RESIDTR	512	MSF	RES	D-PHENOTHRIN	AER	2278	FLO	2			S	98
5.	ROACHES	RESIDTR	2	MSF	EXC	D-PHENOTHRIN	AER	12	FLO	2			S	1
6.	ROACHES	RESIDTR	56	MSF	BRQ	D-PHENOTHRIN	AER	64	FLO	2			S	4
7.	ROACHES	RESIDTR	38	MSF	WHS	D-PHENOTHRIN	AER	132	FLO	2			S	5
8.	ROACHES	RESIDTR	297	MSF	RCH	D-PHENOTHRIN	AER	534	FLO	2			S	27
9.	ROACHES	RESIDTR	6	MSF	IND	D-PHENOTHRIN	AER	12	FLO	2			S	1
10.	MXGRABDLVD	ENGDINSSUR			OPG									5
11.	ODOR	ENGDINSSUR			WHS									7
12.	OTP (ALLIGATOR)	SPHAND	8	MSF	WHS	IODINE	EML	4	ZGL	1.6			N	6
13.	ODOR	ENGDINSSUR			RES									1
14.	ODOR (DOG)	OMCONTROL	10	MCF	RES	ULD-20	SLN		FLO	NA			N	2
15.	MILLIPEDE	EXRESIDTR	2	AC	OPG	DURSBAN	EML	60	ZGL	.01			N	4
16.	TENT LEA (CATERPILLARS)	SPPDEQ	2	TRE	EA	DURSBAN	EML	10		.01			N	2
17.	FIREANTS	EXBAIT	2	AC	OPG	AMDRO	GRN	2	PDW	.88			N	2
18.	ROACHES	RESIDTR	112	MSF	RES	DURSBAN	EML	42	ZGL	.5			C	56
19.	ROACHES	RESIDTR	48	MSF	RES	PYRETHRUM	AER		FLO		4	.25	C	4

NO	TARGET PEST NAME (a)	OPERATION				PESTICIDE							TIME HOURS (n)	
		NAME (b)	TOTAL UNITS TREATED (c)	UNIT (d)	SITE (e)	NAME (f)	FORM (g)	APPLICATION		FINAL CONC. % (j)	RATE (PER AREA UNIT)			SUPPLY SOURCE ENTER S, N, G, C (m)
								AMOUNT (h)	UNIT (i)		LBS (k)	% (l)		
13-15		17-19	20-24	25-27	28-30	31-33	34-36	37-41	42-43	44-49	50-55	56-58	68	69-71
20.	ROACHES	INBAIT	92	MSF	FHB	OSY (COMBAT)	BTS	8	PDW	1.65			S	28
21.	ROACHES	INTRAP	2	MSF	EXC									1
22.	ROACHES	INTRAP (GLUE)	4	MSF	RCH									2
23.	CARCASS	OMCONTROL	1	EA	RES									4
24.	BRUSH	CLEARING	37	AC	OPG									69
25.	BIRD (NEST)	OMCONTROL	6	EA	RES									6
26.	BIRD	OMCONTROL	2	MSF	RCH	OMI (ROSTREPEL)	GLU	2	PDW	NA			N	4
27.	BDLVDWEED	ENGDINSSUR			OPG									3
28.	BDLVDWEED	SPPDEQ	36	AC	OPG	GLYPHOSATE	EML	1400	ZGL	1			N	69
29.	BDLVDWEED	SPPDEQ	295	AC	OPG	2 4 D	EML	4020	ZGL	1			N	58
30.	BAGWORM	SPPDEQ	6	AC	OPG	DIMETHOATE	EML	60	ZGL	1			N	14

REMARKS

INSTRUCTIONS FOR USE

- Detailed instructions of the implementing department directive shall be used in the preparation of this report.
- Military installations shall prepare this report by the 15th day after the end of each month. The report shall be prepared and signed by the DOD certified pest management supervisor, applicator or inspector and by the installation engineer.
- Three copies shall be signed and distributed as follows:
  - Copy No. 1. To the appropriate pest management professional in accordance with implementing department directives for technical review.
  - Copy No. 2. Record to the installation surgeon.
  - Copy No. 3. Record copy to the installations engineer for two year retention in accordance with Public Law 92-516.

INSTALLATION ENGINEER  
(Reviewing Officer)

TYPED NAME: M. G. LILLEY, COL  
BASE MAINTENANCE OFFICER

SIGNATURE: *M. G. Lilley*

DATE (yyymmdd): 10/27/87

INSTALLATION CERTIFIED PEST MANAGEMENT SUPERVISOR,  
APPLICATOR, OR INSPECTOR

TYPED NAME: MAJOR H. GRAY  
PEST CONTROL FOREMAN

SIGNATURE: *Major H. Gray*

DATE (yyymmdd): 871021

## PEST MANAGEMENT REPORT

C.D. CODE UIC  
10 25 3M 46 57 60 70 81 88 107 110 126  
REPORT CONTROL SYMBOL  
DD-M(A&R) 1080NAME OF MAJOR OR REVIEWING COMMAND  
COMMANDER ATLANTIC DIV. (10-A)  
NAVAL FACILITIES ENGINEERING CMDADDRESS  
NORFOLK, VA 23511NAME OF REPORTING INSTALLATION  
MARINE CORPS BASEADDRESS  
CAMP LEJEUNE, NC 28542

NO	TARGET PEST NAME (a)	OPERATION				PESTICIDE							TIME HOURS (n)														
		NAME (b)	TOTAL UNITS TREATED (c)	UNIT (d)	SITE (e)	NAME (f)	FORM (g)	APPLICATION		FINAL CONC. % (j)	RATE (PER AREA UNIT)			SUPPLY SOURCE ENTER S, N, G, C (m)													
								AMOUNT (h)	UNIT (i)		LBS. (k)	% (l)															
13-15		17-19		20-24		25-27		28-30		31-33		34-36		37-41		42-43		44-49		50-55		56-58		68		69-71	
1.	ROACHES	RESIDTR	46	MSF	OFF	DIAZINON	EML	19	ZGL	1							S	30									
2.	ROACHES	RESIDTR	32	MSF	RCH	DIAZINON	EML	8	ZGL	1							S	8									
3.	ROACHES	RESIDTR	386	MSF	RES	DIAZINON	EML	101	ZGL	1							S	112									
4.	ROACHES	RESIDTR	42	MSF	WHS	DURSBAN	EML	5	ZGL	.5							N	6									
5.	ROACHES	RESIDTR	48	MSF	WHS	DIAZINON	EML	15	ZGL	1							S	41									
6.	ROACHES	RESIDTR	2	MSF	WHS	DURSBAN	SLN	2	ZGL	2							N	3									
7.	ROACHES	RESIDTR	48	MSF	RES	DURSBAN	EML	16	ZGL	1							C	16									
8.	ROACHES	RESIDTR	194	MSF	RES	DURSBAN	EML	42	ZGL	.5							N	41									
9.	ROACHES	RESIDTR	28	MSF	BRQ	DURSBAN	EML	4	ZGL	.5							N	4									
10.	ROACHES	RESIDTR	138	MSF	RCH	DURSBAN	EML	9	ZGL	.5							N	11									
11.	ROACHES	RESIDTR	68	MSF	OFF	DURSBAN	EML	4	ZGL	.5							N	6									
12.	CENTIPEDE	SPPDEQ	4	AC	OPG	DURSBAN	EML	70	ZGL	.01							N	4									
13.	CARPENTANT	SPPDEQ	2	EA	OPG	DURSBAN	EML	30	ZGL	.01							N	2									
14.	ROACHES	RESIDTR	14	MSF	EXC	DURSBAN	EML	2	ZGL	.5							N	3									
15.	ROACHES	INBAIT	350	MSF	RES	OSY (COMBAT)	BTS	3	PDW	1.65		SELF-HRLP					S	176									
16.	ROACHES	INBAIT	90	MSF	EXC	OSY (COMBAT)	BTS	4	PDW	1.65							S	25									
17.	ROACHES	INBAIT	6	MSF	RES	OSY (COMBAT)	BTS	1	PDW	1.65							S	1									
18.	ROACHES	INBAIT	120	MSF	RCH	OSY (COMBAT)	BTS	6	PDW	1.65							S	31									
19.	ROACHES	INBAIT	24	MSF	OFF	OSY (COMBAT)	BTS	1	PDW	1.65							S	3									

NO	TARGET PEST		OPERATION			PESTICIDE							TIME	
	NAME (a)	NAME (b)	TOTAL UNITS TREATED (c)	UNIT (d)	SITE (e)	NAME (f)	FORM (g)	APPLICATION		FINAL CONC. % (j)	RATE (PER AREA UNIT)		SUPPLY SOURCE	HOURS (n)
								AMOUNT (h)	UNIT (i)		LBS. (k)	% (l)	ENTER S, N, G, C (m)	
	13-15	17-19	20-24	25-27	28-30	31-33	34-36	37-41	42-43	44-49	50-55	56-58	68	69-71
20.														
21.														
22.														
23.														
24.														
25.														
26.														
27.														
28.														
29.														
30.														

REMARKS

INSTRUCTIONS FOR USE

1. Detailed instructions of the implementing department directive shall be used in the preparation of this report.
2. Military installations shall prepare this report by the 15th day after the end of each month. The report shall be prepared and signed by the DOD certified pest management supervisor, applicator or inspector and by the installation engineer.
3. Three copies shall be signed and distributed as follows:
  - a. Copy No. 1. To the appropriate pest management professional in accordance with implementing department directives for technical review.
  - b. Copy No. 2. Record to the installation surgeon.
  - c. Copy No. 3. Record copy to the installations engineer for two year retention in accordance with Public Law 92-516.

INSTALLATION ENGINEER  
(Reviewing Officer)

SIGNATURE

TYPED NAME  
M. G. LILLEY, COL  
BASE MAINTENANCE OFFICER

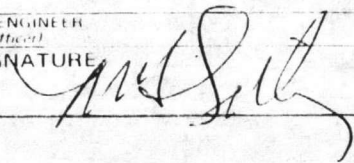

DATE (yyymmdd)  
10/27/87

INSTALLATION CERTIFIED PEST MANAGEMENT SUPERVISOR,  
APPLICATOR, OR INSPECTOR

SIGNATURE

TYPED NAME  
MAJOR H. GRAY  
PEST CONTROL FOREMAN

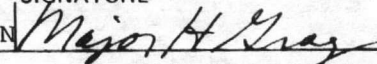

DATE (yyymmdd)  
871021



PEST MANAGEMENT REPORT

C.D. CODE UIC  
 10 25 3 M 4 6 5 7 6 0 7 0 8 1 9 8 10 7 11 0 12 6

REPORT CONTROL SYMBOL  
 DD-M(A&R) 1080

NAME OF MAJOR OR REVIEWING COMMAND ADDRESS NAME OF REPORTING INSTALLATION ADDRESS  
 COMMANDER, ATLANTIC DIV. (10-A) NORFOLK, VA 23511 MARINE CORPS BASE CAMP LEJEUNE, NC 28542  
 NAVAL FACILITIES ENGINEERING CMD

NO	TARGET PEST NAME (a)	OPERATION NAME (b)	OPERATION			PESTICIDE NAME (f)	FORM (g)	APPLICATION		FINAL CONC. % (j)	RATE (PER AREA UNIT)		SUPPLY SOURCE ENTER S, N, G, C (m)	TIME HOURS (n)
			TOTAL UNITS TREATED (c)	UNIT (d)	SITE (e)			AMOUNT (h)	UNIT (i)		LBS. (k)	% (l)		
			13-15	17-19	20-24			25-27	28-30		31-33	34-36		
1.	ANT	SPPDEQ	36	AC	OPG	CARBARYL	SUS	1200	ZGL	.12			S	15
2.	ANT	INBAIT	2	MSF	BRQ	COMBAT	BTS	1	PDW	.9			N	4
3.	ANT	INBAIT	2	MSF	FHB	COMBAT	BTS	1	PDW	.9			N	1
4.		TRAINING												4
5.		MAINTENANCE												141
6.		PROGRAMMING												194
7.		NONPROGRAM												278
8.														
9.														
10.														
11.														
12.														
13.														
14.														
15.														
16.														
17.														
18.														
19.														

NO	TARGET PEST	OPERATION				PESTICIDE							TIME HOURS (n)		
		NAME (a) 13-15	NAME (b) 17-19	TOTAL UNITS TREATED (c) 20-24	UNIT (d) 25-27	SITE (e) 28-30	NAME (f) 31-33	FORM (g) 34-36	APPLICATION		FINAL CONC. % (j) 44-49	RATE (PER AREA UNIT)		SUPPLY SOURCE ENTER S, N, G, C (m) 68	
									AMOUNT (h) 37-41	UNIT (i) 42-43		LBS (k) 50-55			% (l) 56-58
20.	SUBTERMS		ENGDINSSUR			RES									12
21.	SUBTERMS		SURSOILTR	80	MLF	UTL	CHLORDANE	EML	40	ZGL	1			S	8
22.	SUBTERMS		SURSOILTR	10	MSF	OFF	CHLORDANE	EML	100	ZGL	1			S	16
23.	SUBTERMS		TRNSOILTR	328	MCF	RES	CHLORDANE	EML	60	ZGL	1			S	8
24.	SUBTERMS		INJECTSOIL	150	CF	OFF	CHLORDANE	EML	100	ZGL	1			S	10
25.	FILTHFLIES		ENGDINSSUR			FHB									2
26.	FILTHFLIES		ENGDINSSUR			RCH									2
27.	FILTHFLIES		STEAMCLEAN	73	EA	TGC									219
28.	FILTHFLIES		RESIDTR	30	AC	LDF	DIMETHOATE	EML	240	ZGL	1			N	26
29.	FILTHFLIES		RESIDTR	274	MSF	KEN	DIMETHOATE	EML	510	ZGL	1			N	62
30.	TABANID		FOGGING	80	AC	WOO	MALATHION	SLN	2	ZGL	95			N	6

REMARKS

- INSTRUCTIONS FOR USE
- Detailed instructions of the implementing department directive shall be used in the preparation of this report.
  - Military installations shall prepare this report by the 15th day after the end of each month. The report shall be prepared and signed by the DOD certified pest management supervisor, applicator or inspector and by the installation engineer.
  - Three copies shall be signed and distributed as follows:
    - Copy No. 1. To the appropriate pest management professional in accordance with implementing department directives for technical review.
    - Copy No. 2. Record to the installation surgeon.
    - Copy No. 3. Record copy to the installations engineer for two year retention in accordance with Public Law 92-516.

INSTALLATION ENGINEER  
(Reviewing Officer)  
TYPED NAME M. G. LILLEY, COL  
BASE MAINTENANCE OFFICER  
SIGNATURE *M. G. Lilley*  
DATE (yyymmdd) 10/24/87

INSTALLATION CERTIFIED PEST MANAGEMENT SUPERVISOR,  
APPLICATOR, OR INSPECTOR  
TYPED NAME MAJOR H. GRAY  
PEST CONTROL FOREMAN  
SIGNATURE *Major H Gray*  
DATE (yyymmdd) 871021

## PEST MANAGEMENT REPORT

 CD CODE 10 25 3 M 4 6 5 7 6 0 7 0 8 1 9 8 10 7 11 0 12 7  
 REPORT CONTROL SYMBOL DD MIA&ARI 1080

 NAME OF MAJOR OR REVIEWING COMMAND ADDRESS NAME OF REPORTING INSTALLATION ADDRESS  
 COMMANDER, ATLANTIC DIV (10-4) NAVAL FACILITIES ENGINEERING CMD NORFOLK, VA 23511 MARINE CORPS BASE CAMP LEJEUNE, NC 28542

NO.	TARGET PEST	OPERATION				PESTICIDE							TIME	
	NAME (a)	NAME (b)	TOTAL UNITS TREATED (c)	UNIT (d)	SITE (e)	NAME (f)	FORM (g)	APPLICATION		FINAL CONC % (j)	RATE (PER AREA UNIT)		SUPPLY SOURCE ENTER S, N, G, C (m)	HOURS (n)
								AMOUNT (h)	UNIT (i)		LBS (k)	% (l)		
	13-15	17-19	20-24	25-27	28-30	31-33	34-36	37-41	42-43	44-49	50-55	56-58	60	69-71
1.	MOSQUITOES	FOGGING	1281	AC	OPG	MALATHION	SLN	33	ZGL	95			S	33
2.	MOSQUITOES	FOGGING	2831	AC	WOO	MALATHION	SLN	52	ZGL	95			S	53
3.	MOSQUITOES	ENGDINSSUR			IMP									4
4.	TICKS	MISTING	24	AC	WOO	MALATHION	EML	550	ZGL	1.00			S	5
5.	TICKS	SPPDEQ	11	AC	OPG	DURSBAN	EML	220	ZGL	.01			N	12
6.	TICKS	SPPDEQ	7	AC	WOO	MALATHION	EML	130	ZGL	1			S	5
7.	TICKS	MISTING	20	AC	OPG	MALATHION	EML	220	ZGL	1			S	9
8.	WOB	SPCTR	14	MCF	BRO	PYRETHRUM	AER	101	FLO	.05			N	5
9.	WOB	RESIDTR	8	MSF	OPG	DIAZINON	EML	1	ZGL	1			S	1
10.	WOB	EXRESIDTR	57	MSF	OPG	PYRETHRUM	AER	220	FLO	.05			N	5
11.	WOB	EXRESIDTR	5	MSF	RES	PYRETHRUM	AER	104	FLO	.05			N	16
12.	WOB	SPCTR	12	MCF	UTL	PYRETHRUM	AER	25	FLO	.05			N	2
13.	WOB	SPCTR	1	MCF	IND	PYRETHRUM	AER	4	FLO	.05			N	1
14.	WOB	EXRESIDTR	14	MSF	RCH	PYRETHRUM	AER	59	FLO	.05			N	6
15.	WOB	ENGDINSSUR			RCH									1
16.	WOB	ENGDINSSUR			OPG									1
17.	WOB	ENGDINSSUR			RES									1
18.	MOSQUITOES	MEDDINSSUR												132
19.	SUBTERMS	ENGDINSSUR			WHS									2

NO	TARGET PEST		OPERATION			PESTICIDE						TIME		
	NAME (a)	NAME (b)	TOTAL UNITS TREATED (c)	UNIT (d)	SITE (e)	NAME (f)	FORM (g)	APPLICATION		FINAL CONC. % (j)	RATE (PER AREA UNIT)		SUPPLY SOURCE ENTER S, N, G, C (m)	HOURS (n)
								AMOUNT (h)	UNIT (i)		LBS (k)	% (l)		
	13 15	17 19	20 24	25 27	28 30	31 33	34 36	37 41	42 43	44 49	50 55	56 58	68	69 71
20	SUBTERMS	ENGDINSSUR			RES									12
21	MOSQUITOES	SPHAND	99	AC	IMP	FLITMO	SLN	208	ZGL	98.5			N	168
22	MOSQUITOES	MISTING	182	AC	WOO	MALATHION	EML	1031	ZGL	1			S	31
23	MOSQUITOES	MISTING	272	AC	OPG	MALATHION	EML	2000	ZGL	1			S	46
24	LEA (BAGWORM)	SPPDEQ	10	AC	OPB	DIMETHOATE	EML	550	ZGL	.5			N	20
25	CARCASS	ENGDINSSUR												1
26	FILTHELIES	ENGDINSSUR			LDF									2
27	FILTHELIES	STEAMCLEAN	75	EA	TGC									145
28	FILTHELIES	RESIDTR	8	AC	LDF	DIMETHOATE	EML	90	ZGL	1			N	6
29	FILTHELIES	RESIDTR	47	MSF	KEN	DIMETHOATE	EML	160	ZGL	1			N	18
30	FILTHELIES	EXRESIDTR	1	AC	OPG	MALATHION	EML	20	ZGL	1			S	2

## REMARKS

## INSTRUCTIONS FOR USE

- Detailed instructions of the implementing department directive shall be used in the preparation of this report.
- Military installations shall prepare this report by the 15th day after the end of each month. The report shall be prepared and signed by the DOD certified pest management supervisor, applicator or inspector and by the installation engineer.
- Three copies shall be signed and distributed as follows:
  - Copy No. 1. To the appropriate pest management professional in accordance with implementing department directives for technical review.
  - Copy No. 2. Record to the installation surgeon.
  - Copy No. 3. Record copy to the installations engineer for two year retention in accordance with Public Law 92-516.

INSTALLATION ENGINEER  
(Reviewing Officer)TYPED NAME  
M. G. LILLEY, COL.  
BASE MAINTENANCE OFFICER

SIGNATURE

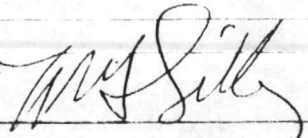

DATE (yyymmdd)

11/16/87

INSTALLATION CERTIFIED PEST MANAGEMENT SUPERVISOR,  
APPLICATOR, OR INSPECTORTYPED NAME  
MAJOR NAME. GRAY  
PEST CONTROL FOREMAN

SIGNATURE

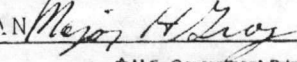

DATE (yyymmdd)

871112

PEST MANAGEMENT REPORT

CD CODE 1012 53 M 46 5 7 6 0 7 0 8 1 9 8 10 7 11 0 12 7  
 UIC REPORT CONTROL SYMBOL DD-MI(ABAR) 1080

NAME OF MAJOR OR REVIEWING COMMAND ADDRESS  
 COMMANDER, ATLANTIC DIV. (10-A) NAVAL FACILITIES ENGINEERING CMD NORFOLK, VA 23511  
 NAME OF REPORTING INSTALLATION ADDRESS  
 MARINE CORPS BASE CAMP LEJEUNE, NC 28542

NO.	TARGET PEST		OPERATION			PESTICIDE							TIME	
	NAME (a)	NAME (b)	TOTAL UNITS TREATED (c)	UNIT (d)	SITE (e)	NAME (f)	FORM (g)	APPLICATION		FINAL CONC (j)	RATE (PER AREA UNIT)		SUPPLY SOURCE ENTER S. N. G. C. (m)	HOURS (n)
								AMOUNT (h)	UNIT (i)		LBS (k)	% (l)		
	13-15	17-19	20-24	25-27	28-30	31-33	34-36	37-41	42-43	44-49	50-55	56-58	60	69-71
1.	FILTHFLIES	SPPDEQ	20	MSF	KEN	MALATHION	EML	40	ZGL	1			S	6
2.	FILTHFLIES	SPCTR	16	MCF	RCH	PYRETHRUM	SLN	16	FLO	.04			S	2
3.	FLEAS	RESIDTR	26	MSF	BRQ	DURSBAN	EML	3	ZGL	.5			N	3
4.	FLEAS	SPPDEQ	12	MSF	OFF	DURSBAN	EML	4	ZGL	1			N	4
5.	FLEAS	SPCTR	12	MSF	RES	DIAZINON	EML	3	ZGL	1			N	2
6.	FLEAS	RESIDTR	10	MSF	RES	FICAM	SUS	1	ZGL	.25			N	1
7.	FLEAS	RESIDTR	10	MSF	EXC	FICAM	SUS	1	ZGL	1			N	1
8.	FLEAS	RESIDTR	1	MSF	RES	DURSBAN	SUS	1	ZGL	.5			C	1
9.	FLEAS	RESIDTR	15	MSF	RES	DURSBAN	EML	9	ZGL	1			N	10
10.	FLEAS	ENGDINSSUR			RES									3
11.	FIREANTS	SELF-HELP	153	MSF	RES	OSY (AMDRO)	BTS	918	EA	.88			N	10
12.	FIREANTS	SPPDEQ	47	AC	OPG	DURSBAN	EML	273	ZGL	.01			N	18
13.	FIREANTS	DGHAND	18	AC	OPG	OSY (AMDRO)	BTS	14	PDW	.88			N	15
14.	ANTS	SPPDEQ	10	AC	OPG	DURSBAN	EML	40	ZGL	.01			N	2
15.	ANTS	RESIDTR	1	MSF	RES	DURSBAN	EML	1	ZGL	.01			N	1
16.	ANTS	RESIDTR	4	MSF	OFF	DURSBAN	EML	1	ZGL	.5			N	1
17.	ANTS	RESIDTR	12	MSF	UTL	DURSBAN	EML	1	ZGL	.5			N	1
18.	ANTS	RESIDTR	24	MSF	BRQ	DURSBAN	EML	4	ZGL	.5			N	3
19.	ANTS	DGHAND	1	MSF	BRQ	OSY (COMBAT)	BTS	4	EA	.9			N	1

NO	TARGET PEST NAME (a) 13-15	OPERATION				PESTICIDE							TIME HOURS (n) 69-71	
		NAME (b) 17-19	TOTAL UNITS TREATED (c) 20-24	UNIT (d) 25-27	SITE (e) 28-30	NAME (f) 31-33	FORM (g) 34-36	APPLICATION		FINAL CONC. (j) 44-49	RATE (PER AREA UNIT)			SUPPLY SOURCE
								AMOUNT (h) 37-41	UNIT (i) 42-43		LBS (k) 50-55	% (l) 56-58		ENTER S. N, G, C (m) 68
20	ANTS	RESIDTR	1	MSF	RCH	DIAZINON	EML	1	ZGL	1			S	1
21	ANTS	RESIDTR	1	MSF	OFF	DIAZINON	EML	1	ZGL	1			S	1
22	ANTS	RESIDTR	9	MSF	FHB	DURSBAN	EML	4	ZGL	.5			N	2
23	BIRDS	ENGDINSSUR			OFF									2
24	BIRDS	ENGDINSSUR			RCH									2
25	FOODPEST	ENGDINSSUR			WHS									7
26	FOODPEST	SPCTR	10,000	MCF	WHS	DCHLORVOS	SLN	30	ZGL	5.62			N	10
27	SPIDER	RESIDTR	1	MSF	UTL	DIAZINON	EML	1	ZGL	1			S	1
28	SPIDER	RESIDTR	6	MSF	BRQ	DURSBAN	EML	1	ZGL	.5			N	1
29	SPIDER MITES	SPPDEQ	2	AC	OPG	DIMETHOATE	EML	30	ZGL	1			N	4
30	CENTIPEDE	SPPDEQ	1	AC	OPG	DURSBAN	EML	25	ZGL	.01			N	1

## REMARKS

## INSTRUCTIONS FOR USE

- Detailed instructions of the implementing department directive shall be used in the preparation of this report.
- Military installations shall prepare this report by the 15th day after the end of each month. The report shall be prepared and signed by the DOD certified pest management supervisor, applicator or inspector and by the installation engineer.
- Three copies shall be signed and distributed as follows:
  - Copy No. 1. To the appropriate pest management professional in accordance with implementing department directives for technical review.
  - Copy No. 2. Record to the installation surgeon.
  - Copy No. 3. Record copy to the installations engineer for two year retention in accordance with Public Law 92-516.

INSTALLATION ENGINEER  
(Responsible Official)TYPED NAME  
M. C. LILLEY, COL  
BASE MAINTENANCE OFFICER

SIGNATURE

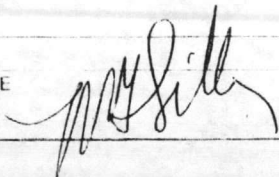
DATE (yyymmdd)  
11/16/87INSTALLATION CERTIFIED PEST MANAGEMENT SUPERVISOR,  
APPLICATOR, OR INSPECTORTYPED NAME  
MAJOR H. GRAY  
PEST CONTROL FOREMAN

SIGNATURE

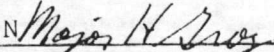
DATE (yyymmdd)  
871112

PEST MANAGEMENT REPORT

CD CODE UIC 01253M46576070819810710127 REPORT CONTROL SYMBOL DD-MI&AR 1080

NAME OF MAJOR OR REVIEWING COMMAND ADDRESS NAME OF REPORTING INSTALLATION ADDRESS  
 COMMANDER, ATLANTIC DIV. (10-A) NAVAL FACILITIES ENGINEERING CMD NORFOLK, VA 23511 MARINE CORPS BASE CAMP LEJEUNE, NC 28542

NO	TARGET PEST NAME (a) 13-15	OPERATION			NAME (f) 31-33	FORM (g) 34-36	PESTICIDE APPLICATION			FINAL CONC % (j) 44-49	RATE (PER AREA UNIT)		SUPPLY SOURCE ENTER S. N, G, C (m) 68	TIME HOURS (n) 69-71
		NAME (b) 17-19	TOTAL UNITS TREATED (c) 20-24	UNIT (d) 25-27			SITE (e) 28-30	AMOUNT (h) 37-41	UNIT (i) 42-43		LBS (k) 50-55	% (l) 56-58		
1.	ALGAE	SPPDEQ	2	AC	GFG	FORE	SUS	21	ZGL	1			N	5
2.	AQUATICWOS	SPPDEQ	6	AC	IMP	DIQUAT	EML	100	ZGL	1			N	6
3.	ROO CUTWORMS	SPPDEQ	2	AC	GFG	CARBARYL	SUS	6	ZGL	.01			N	4
4.	MICE	INTRAP (GLUE)	3	MSF	OFF									1
5.	MICE	INTRAP (GLUE)	1	MSF	FHB									4
6.	MICE	INTRAP	3	MSF	RCH									1
7.	MICE	INTRAP	3	MSF	WHS									2
8.	MICE	ENGDINSSUR			RCH									1
9.	MICE	ENGDINSSUR			FHB									2
10.	MICE	ENGDINSSUR			OFF									1
11.	MICE	INBAIT	3	MSF	EXC	TALON	BTS	1	PDW	.005			N	1
12.	MICE	INBAIT	2	MSF	OFF	TALON	BTS	1	PDW	.005			N	1
13.	MICE	INBAIT	4	MSF	FHB	TALON	BTS	1	PDW	.005			N	1
14.	MICE	INBAIT	2	MSF	WHS	TALON	BTS	1	PDW	.005			N	1
15.	LEA (ARMYWORM)	SPPDEQ	2	GFG		CARBARYL	SUS	6	ZGL	.01			N	4
16.	LEA (TENTCATERPILLARS)	RESIDTR	1	EA	TRE	DURSBAN	EML	1	ZGL	.1			N	2
17.	GRASSYWEED	SPHAND	21	EA	TRE	POAST	EML	6	ZGL	1			N	4
18.	RATS	ENGDINSSUR			RCH									1
19.	RATS	INBAIT	10	MSF	WHS	TALON	BTS	2	PDW	.005			N	1

NO	TARGET PEST NAME (a) 13-15	OPERATION				PESTICIDE							TIME	
		NAME (b) 17-19	TOTAL UNITS TREATED (c) 20-24	UNIT (d) 25-27	SITE (e) 28-30	NAME (f) 31-33	FORM (g) 34-36	APPLICATION		FINAL CONC. % (j) 44-49	RATE (PER AREA UNIT)		SUPPLY SOURCE	HOURS (n) 69-71
								AMOUNT (h) 37-41	UNIT (i) 42-43		LBS. (k) 50-55	% (l) 56-58	ENTER S. N, G, C (m) 68	
20	MXGRABDLVD	SPHAND	49	EA	TRE	GLYPHOSATE	EML	12	ZGL	1			N	11
21	MXCRABDLVD	SPPDEQ	35	AC	OPB	GLYPHOSATE	EML	800	ZGL	1			N	30
22	MXGRABDLVD	SPPDEQ	9	AC	OPG	DIQUAT	EML	685	ZGL	1			N	22
23	MXCRABDLVD	SPPDEQ	80	AC	OPG	GLYPHOSATE	EML	2423	ZGL	1			N	115
24	MXGRABDLVD	SPHAND	5	AC	OPG	GLYPHOSATE	EML	19	ZGL	1			N	13
25	ROACHES	ENGDINSSUR			RES									21
26	ROACHES	ENGDINSSUR			EXC									1
27	ROACHES	ENGDINSSUR			RCH									1
28	ROACHES	ENGDINSSUR			BRQ									1
29	ROACHES	RESIDTR	49	MSF	EXC	D-PHENOTHRIN	AER	56	FLO	2			S	3
30	ROACHES	RESIDTR	44	MSF	BRQ	D-PHENOTHRIN	AER	67	FLO	2			S	3

## REMARKS

## INSTRUCTIONS FOR USE

1. Detailed instructions of the implementing department directive shall be used in the preparation of this report.
2. Military installations shall prepare this report by the 15th day after the end of each month. The report shall be prepared and signed by the DOD certified pest management supervisor, applicator or inspector and by the installation engineer.
3. Three copies shall be signed and distributed as follows:
  - a. Copy No. 1. To the appropriate pest management professional in accordance with implementing department directives for technical review.
  - b. Copy No. 2. Record to the installation surgeon.
  - c. Copy No. 3. Record copy to the installations engineer for two year retention in accordance with Public Law 92-516.

INSTALLATION ENGINEER  
(Reviewing Officer)TYPED NAME  
M.C. LILLEY, COL  
BASE MAINTENANCE OFFICER

SIGNATURE

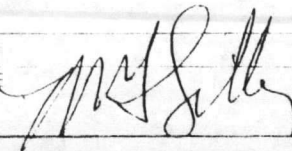

DATE (yyymmdd)

11/16/87

INSTALLATION CERTIFIED PEST MANAGEMENT SUPERVISOR,  
APPLICATOR, OR INSPECTORTYPED NAME  
MAJOR H. GRAY  
PEST CONTROL FOREMAN

SIGNATURE

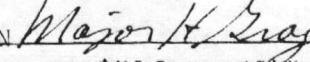

DATE (yyymmdd)

871112



PEST MANAGEMENT REPORT

DD FORM 1080 (10-67) REPORT CONTROL SYMBOL DD-M(A&R) 1080

NAME OF MAJOR OR REVIEWING COMMAND (10-7A) ADDRESS NAME OF REPORTING INSTALLATION ADDRESS  
 COMMANDER, ATLANTIC DIV. (10-7A) NAVAL FACILITIES ENGINEERING CMD NORFOLK, VA 23511 MARINE CORPS BASE CAMP LEJEUNE, NC 28542

NO	TARGET PEST NAME (a)	OPERATION NAME (b)	TOTAL UNITS TREATED (c)	UNIT (d)	SITE (e)	NAME (f)	FORM (g)	PESTICIDE APPLICATION			RATE (PER AREA UNIT)		SUPPLY SOURCE ENTER S, N, C, M (m)	TIME HOURS (n)
								AMOUNT (h)	UNIT (i)	FINAL CONC % (j)	LBS (k)	% (l)		
1.	ROACHES	SELF-HELP			RES	OSY (COMBAT)	BTS	5368	EA	1.65			S	76
2.	ROACHES	INBAIT	1	MSF	RES	OSY (COMBAT)	BTS	1	PDW	1.65			S	1
3.	ROACHES	RESIDTR	28	MSF	RCH	D-PHENOTHRIN	AER	54	FLO	2			S	3
4.	ROACHES	RESIDTR	155	MSF	RES	D-PHENOTHRIN	AER	385	FLO	2			S	39
5.	ROACHES	RESIDTR	12	MSF	UTL	D-PHENOTHRIN	AER	8	FLO	2			S	1
6.	ROACHES	RESIDTR	1	MSF	HOL	D-PHENOTHRIN	AER	1	FLO	2			S	1
7.	ROACHES	RESIDTR	39	MSF	WHS	D-PHENOTHRIN	AER	117	FLO	2			S	9
8.	ROACHES	RESIDTR	97	MSF	RCH	D-PHENOTHRIN	AER	136	FLO	2			S	7
9.	ROACHES	RESIDTR	7	MSF	IND	D-PHENOTHRIN	AER	36	FLO	2			S	2
10.	ROACHES	RESIDTR	10	MSF	FIB	D-PHENOTHRIN	AER	36	FLO	2			S	2
11.	ROACHES	SPCTR	300	MCF	RCH	PYRETHRUM	SLN	1	ZGL	3			N	1
12.	ROACHES	RESIDTR	39	MSF	OFF	D-PHENOTHRIN	AER	56	FLO	2			S	2
13.	PSYCHODA	SPCTR	10	MCF	RCH	PYRETHRUM	SLN	1	SLN	.04			S	2
14.	ANTS	INBAIT	1	MSF		OSY (COMBAT)	BTS	1	PDW	1.65			N	1
15.	ROACHES	RESIDTR	31	MSF	RES	DIAZINON	DUS	8	PDW	1			C	8
16.	ROACHES	SPHAND	68	MSF	RES	DIAZINON	DUS	8	PDW	1			C	28
17.	BDLVDWEED	SPPDEQ	405	AC	OPG	2 4 D	EML	3658	ZGL	1			N	58
18.	ROACHES	RESIDTR	34	MSF	RES	DURSBAN	EML	8	ZGL	.5			C	14
19.	ROACHES	RESIDTR	31	MSF	RES	PYRETHRUM	AER				2	.25	C	2

NO	TARGET PEST		OPERATION			PESTICIDE							TIME	
	NAME (a)	NAME (b)	TOTAL UNITS TREATED (c)	UNIT (d)	SITE (e)	NAME (f)	FORM (g)	APPLICATION		FINAL CONC. % (j)	RATE (PER AREA UNIT)		SUPPLY SOURCE	HOURS (n)
								AMOUNT (h)	UNIT (i)		LBS. (k)	% (l)	ENTER S. N, G, C (m)	
13-15	17-19	20-24	25-27	28-30	31-33	34-36	37-41	42-43	44-49	50-55	56-58	68	69-71	
20.	B.D.L.V.D.WEED	ENGDINSSUR			OPG									12
21.	B.D.L.V.D.WEED	SPPDEQ	2	AC	OPG	ARSENICORG	EML	100	ZGL	1			N	2
22.	BRUSH	CLEARING	18	AC	OPG									88
23.	BRUSH	CLEARING	10	AC	WOO									70
24.	FLEAS	RESIDTR	10	MSF	RCH	DURSBAN	EML	1	ZGL	.5			N	1
25.	FLEAS	DUST	1	MSF	RES	FICAM	DUS	2	PDW	1			N	1
26.	ROACHES	RESIDTR	1	MSF	BRG	DIAZINON	EML	1	ZGL	1			S	1
27.	ROACHES	RESIDTR	6	MSF	BRQ	DIAZINON	EML	2	ZGL	1			S	2
28.	ROACHES	RESIDTR	3	MSF	EXC	DIAZINON	EML	3	ZGL	1			S	3
29.	ANTS	ENGDINSSUR			OFF									3
30.	ROACHES	RESIDTR	9	MSF	IND	DIAZINON	EML	4	ZGL	1			S	4

REMARKS

INSTRUCTIONS FOR USE

- Detailed instructions of the implementing department directive shall be used in the preparation of this report.
- Military installations shall prepare this report by the 15th day after the end of each month. The report shall be prepared and signed by the DOD certified pest management supervisor, applicator or inspector and by the installation engineer.
- Three copies shall be signed and distributed as follows:
  - Copy No. 1. To the appropriate pest management professional in accordance with implementing department directives for technical review.
  - Copy No. 2. Record to the installation surgeon.
  - Copy No. 3. Record copy to the installations engineer for two year retention in accordance with Public Law 92-516.

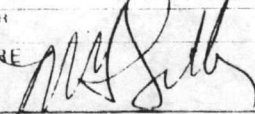
INSTALLATION ENGINEER  
(Reviewing Officer)  
TYPED NAME M. C. LILLEY, COL.  
SIGNATURE   
BASE MAINTENANCE OFFICER

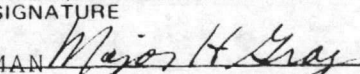
INSTALLATION CERTIFIED PEST MANAGEMENT SUPERVISOR,  
APPLICATOR, OR INSPECTOR  
TYPED NAME MAJOR H. GRAY  
SIGNATURE   
PEST CONTROL FOREMAN DATE (yyymmdd) 871112

PEST MANAGEMENT REPORT

CD CODE 10 25 UIC 3 M 4 6 5 7 6 (7 0) 8 1 9 8 10 7 11 0 12 7 REPORT CONTROL SYMBOL DD-M(A&R) 1080

NAME OF MAJOR OR REVIEWING COMMAND ADDRESS  
 COMMANDER, ATLANTIC DIV. (10-A)  
 NAVAL FACILITIES ENGINEERING CMD NORFOLK, VA 23511

NAME OF REPORTING INSTALLATION ADDRESS  
 MARINE CORPS BASE CAMP LEJEUNE, NC 28542

NO	TARGET PEST NAME (a)	OPERATION			PESTICIDE NAME (f)	FORM (g)	APPLICATION			FINAL CONC % (j)	RATE (PER AREA UNIT)		SUPPLY SOURCE ENTER S, N, G, C (m)	TIME HOURS (n)
		NAME (b)	TOTAL UNITS TREATED (c)	UNIT (d)			SITE (e)	AMOUNT (h)	UNIT (i)		LBS (k)	% (l)		
1.	ROACHES	RESIDTR	1	MSF	OFF	DIAZINON	EML	1	ZGL	1			S	1
2.	ROACHES	RESIDTR	101	MSF	RCH	DIAZINON	EML	4	ZGL	1			S	4
3.	ROACHES	RESIDTR	148	MSF	RES	DIAZINON	EML	68	ZGL	1			S	45
4.	ANTS	SPPDEQ	1	AC	OPG	DURSBAN	EML	1	ZGL	.01			N	1
5.	ROACHES	RESIDTR	15	MSF	WHS	DIAZINON	EML	12	ZGL	1			S	7
6.	ROACHES	RESIDTR	46	MSF	WHS	DURSBAN	EML	6	ZGL				N	8
7.	ROACHES	RESIDTR	12	MSF	RES	DURSBAN	EML	4	ZGL	.25			C	7
8.	ROACHES	RESIDTR	4	MSF	RES	DURSBAN	EML	1	ZGL	.5			N	2
9.	ROACHES	RESIDTR	100	MSF	RCH	DURSBAN	EML	9	ZGL	.5			N	10
10.	ROACHES	RESIDTR	3	MSF	HOL	DURSBAN	EML	1	ZGL	.5			N	1
11.	ROACHES	RESIDTR	42	MSF	OFF	DURSBAN	EML	3	ZGL	.5			N	5
12.	ROACHES	RESIDTR	58	MSF	BRQ	DURSBAN	EML	11	ZGL	.5			N	14
13.	ROACHES	RESIDTR	12	MSF	UTL	DURSBAN	EML	1	ZGL	.5			N	1
14.	ROACHES	RESIDTR	15	MSF	EXC	DURSBAN	EML	2	ZGL	.5			N	2
15.	ROACHES	RESIDTR	18	MSF	IND	DURSBAN	EML	3	ZGL	.5			N	4
16.	ROACHES	INTRAP	1	MSF										1
17.	ROACHES	INBAIT	136	MSF	EXC	OSY (COMBAT)	BTS	3	PDW	1.65			S	17
18.	ROACHES	INBAIT	106	MSF	RCH	OSY (COMBAT)	BTS	2	PDW	1.65			S	11
19.	ROACHES	INBAIT	1	MSF	WHS	OSY (COMBAT)	BTS	1	PDW	1.65			S	2

NO.	TARGET PEST NAME (a) 13-15	OPERATION			PESTICIDE								TIME	
		NAME (b) 17-19	TOTAL UNITS TREATED (c) 20-24	UNIT (d) 25-27	SITE (e) 28-30	NAME (f) 31-33	FORM (g) 34-36	APPLICATION		FINAL CONC. % (j) 44-49	RATE (PER AREA UNIT)		SUPPLY SOURCE	HOURS (n) 69-71
								AMOUNT (h) 37-41	UNIT (i) 42-43		LBS. (k) 50-55	% (l) 56-58	ENTER S, N, G, C (m) 68	
20.	ROACHES	INBAIT	157	MSF	FHE	OSY (COMBAT)	BTS	7	PDW	1.65			N	38
21.	ROACHES	INTRAP (GLUE)	2	MSF	OFF									1
22.	ROACHES	INTRAP (GLUE)	1	MSF	IND									1
23.	FLEAS	SPPDEQ	1	AC	OPG	DURSBAN	EML	25	ZGL	.01			N	1
24.	MXGRABDLVD	ENGDINSSUR			OPC									3
25.		PROGRAMMING												232
26.		NONPROGRAM												394
27.		MAINTENANCE												109
28.														
29.														
30.														

## REMARKS

## INSTRUCTIONS FOR USE

- Detailed instructions of the implementing department directive shall be used in the preparation of this report.
- Military installations shall prepare this report by the 15th day after the end of each month. The report shall be prepared and signed by the DOD certified pest management supervisor, applicator or inspector and by the installation engineer.
- Three copies shall be signed and distributed as follows:
  - Copy No. 1. To the appropriate pest management professional in accordance with implementing department directives for technical review.
  - Copy No. 2. Record to the installation surgeon.
  - Copy No. 3. Record copy to the installations engineer for two year retention in accordance with Public Law 92-516.

INSTALLATION ENGINEER  
(Reviewing Officer)INSTALLATION CERTIFIED PEST MANAGEMENT SUPERVISOR,  
APPLICATOR, OR INSPECTORTYPED NAME  
M. C. LILLEY, COL.  
BASE MAINTENANCE OFFICER

SIGNATURE

DATE (yyymmdd)

12/16/87

TYPED NAME  
MAJOR H. GRAY  
PEST CONTROL FOREMAN

SIGNATURE

DATE (yyymmdd)

871112

PEST MANAGEMENT REPORT

CD CODE UIC 0 1 2 5 3 M 4 6 5 7 6 0 7 0 8 1 9 8 10 7 11 12 4  
 REPORT CONTROL SYMBOL DD-M(A&R) 1090

NAME OF MAJOR OR REVIEWING COMMAND  
 COMMANDER, ATLANTIC DIV (10-A)  
 NAVAL FACILITIES ENGINEERING CMD  
 ADDRESS  
 NORFOLK

*Glennie Smith*

NAME OF REPORTING INSTALLATION  
 MARINE CORPS BASE  
 ADDRESS  
 CAMP LEJEUNE, NC 28542

NO.	TARGET PEST		OPERATION			PESTICIDE							TIME
	NAME (a)	NAME (b)	TOTAL UNITS TREATED (c)	AC	WOO	AMOUNT (h)	UNIT (i)	FINAL CONC. % (j)	RATE (PER AREA UNIT)		SUPPLY SOURCE ENTER S. N, G, C (m)	HOURS (n)	
									LBS. (k)	% (l)			
	13-15	17-19	20-24			34-36	37-41	42-43	44-49	50-55	56-58	68	69-71
1.	MOSQUITOES	FOGGING	240									S	7
2.	MOSQUITOES	FOGGING	80	AC	WOO	MALATHION	SLN	2	ZGL	95		S	2
3.	MOSQUITOES	ENGDINSSUR				IMP							5
4.	MOSQUITOES	DGHAND	40	AC	WOO	BRIQUETTES	BQT	8	PDW	10		N	6
5.	MOSQUITOES	DGHAND	10	AC	OPG	BRIQUETTES	BQT	2	PDW	10		N	3
6.	WOB	SPCTR	2	MCF	RES	PYRETHRUM	SLN	1	ZGL	.04		S	2
7.	WOB	EXRESIDTR	1	AC	OPG	DURSBAN	EML	2	ZGL	.01		N	1
8.	WOB	SPCTR	20	MCF	BRQ	PYRETHRUM	AER	100	FLO	.05		N	2
9.	WOB	SPCTR	1	MCF	OFF	PYRETHRUM	AER	12	FLO	.05		N	1
10.	WOB	EXRESIDTR	16	MSF	OPG	PYRETHRUM	AER	139	FLO	.05		N	5
11.	WOB	EXRESIDTR	4	MSF	RES	PYRETHRUM	AER	15	FLO	.05		N	2
12.	WOB	RESIDTR	2	MCF	UTL	PYRETHRUM	AER	40	FLO	.05		N	3
13.	WOB	RESIDTR	1	MCF	WHS	PYRETHRUM	AER	16	FLO	.05		N	1
14.	WOB	OMCONTROL				FHB							2
15.	WOB	ENGDINSSUR				BRQ							2
16.	WOB	ENGDINSSUR				OFF							1
17.	WOB	ENGIDINSSUR				RES							1
18.	MOSQUITOES	MEDDINSSUR											21
19.	SUBTERMS	ENGDINSSUR				WHS							3

NO	TARGET PEST		OPERATION			PESTICIDE							TIME	
	NAME (a)	NAME (b)	TOTAL UNITS TREATED (c)	UNIT (d)	SITE (e)	NAME (f)	FORM (g)	APPLICATION		FINAL CONC. % (j)	RATE (PER AREA UNIT)		SUPPLY SOURCE	HOURS (n)
								AMOUNT (h)	UNIT (i)		LBS. (k)	% (l)	ENTER S, N, G, C (m)	
	13-15	17-19	20-24	25-27	28-30	31-33	34-36	37-41	42-43	44-49	50-55	56-58	68	69-71
20.	SUBTERMS	ENGDINSSUR			RES									33
21.	SUBTERMS	SURSOILTR	280	MSF	RES	CHLORDANE	EML	106	ZGL	1			S	10
22.	SUBTERMS	INJECTSOIL	58	CF	OFF	CHLORDANE	EML	60	ZGL	1			S	7
23.	SUBTERMS	TRNSOILTR	444	CF	RES	CHLORDANE	EML	120	ZGL	1			S	9
24.	SUBTERMS	INJECTSOIL	140	CF	RES	CHLORDANE	EML	105	ZGL	1			S	14
25.	SUBTERMS	INJECTSOIL	15	CF	RCH	CHLORDANE	EML	10	ZGL	1			S	4
26.	SUBTERMS	ENGDINSSUR			RCH									5
27.	SUBTERMS	ENGDINSSUR			UTL									1
28.	SUBTERMS	ENGDINSSUR			FHB									2
29.	SUBTERMS	ENGDINSSUR			OFF									9
30.	SAP (APHID)	EXRESIDTR	2	AC	OPG	DIAZINON	EML	20	ZGL	1			S	4

## REMARKS

## INSTRUCTIONS FOR USE

- Detailed instructions of the implementing department directive shall be used in the preparation of this report.
- Military installations shall prepare this report by the 15th day after the end of each month. The report shall be prepared and signed by the DOD certified pest management supervisor, applicator or inspector and by the installation engineer.
- Three copies shall be signed and distributed as follows:
  - Copy No. 1. To the appropriate pest management professional in accordance with implementing department directives for technical review.
  - Copy No. 2. Record to the installation surgeon.
  - Copy No. 3. Record copy to the installations engineer for two year retention in accordance with Public Law 92-516.

INSTALLATION ENGINEER  
(Reviewing Officer)INSTALLATION CERTIFIED PEST MANAGEMENT SUPERVISOR,  
APPLICATOR, OR INSPECTORTYPED NAME  
M. G. LILLEY, COL  
BASE MAINTENANCE OFFICER

SIGNATURE

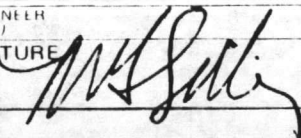

DATE (yyymmdd)

9/23/87

TYPED NAME  
MAJOR H. GRAY  
PEST CONTROL FOREMAN

SIGNATURE

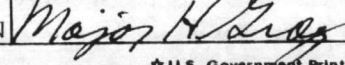

DATE (yyymmdd)

870922

PEST MANAGEMENT REPORT

CD CODE UIC REPORT CONTROL SYMBOL  
 0 2 5 3 M 4 6 5 7 6 0 7 0 8 1 9 8 10 7 10 12 4 DD-M(ABAR) 1000

NAME OF MAJOR OR REVIEWING COMMAND ADDRESS NAME OF REPORTING INSTALLATION ADDRESS  
 COMMANDER, ATLANTIC DIV (10-A) NORFOLK, VA 23511 MARINE CORPS BASE CAMP LEJEUNE, NC 28542  
 NAVAL FACILITIES ENGINEERING CMD

NO	TARGET PEST		OPERATION			PESTICIDE							TIME	
	NAME (a)	NAME (b)	TOTAL UNITS TREATED (c)	UNIT (d)	SITE (e)	NAME (f)	FORM (g)	APPLICATION		FINAL CONC. % (j)	RATE (PER AREA UNIT)		SUPPLY SOURCE ENTER S. N, G, C (m)	HOURS (n)
								AMOUNT (h)	UNIT (i)		LBS. (k)	% (l)		
	13-15	17-19	20-24	25-27	28-30	31-33	34-36	37-41	42-43	44-49	50-55	56-58	60	69-71
1.	MOSQUITOES	FOGGING	240	AC	OPG	MALATHION	SLN	6	ZGL	95			S	7
2.	MOSQUITOES	FOGGING	80	AC	WOO	MALATHION	SLN	2	ZGL	95			S	2
3.	MOSQUITOES	ENGDINSSUR			IMP									5
4.	MOSQUITOES	DGHAND	40	AC	WOO	BRIQUETTES	BQT	8	PDW	10			N	6
5.	MOSQUITOES	DGHAND	10	AC	OPG	BRIQUETTES	BQT	2	PDW	10			N	3
6.	WOB	SPCTR	2	MCF	RES	PYRETHRUM	SLN	1	ZGL	.04			S	2
7.	WOB	EXRESIDTR	1	AC	OPG	DURSBAN	EML	2	ZGL	.01			N	1
8.	WOB	SPCTR	20	MCF	BRQ	PYRETHRUM	AER	100	FLO	.05			N	2
9.	WOB	SPCTR	1	MCF	OFF	PYRETHRUM	AER	12	FLO	.05			N	1
10.	WOB	EXRESIDTR	16	MSF	OPG	PYRETHRUM	AER	139	FLO	.05			N	5
11.	WOB	EXRESIDTR	4	MSF	RES	PYRETHRUM	AER	15	FLO	.05			N	2
12.	WOB	RESIDTR	2	MCF	UTL	PYRETHRUM	AER	40	FLO	.05			N	3
13.	WOB	RESIDTR	1	MCF	WHS	PYRETHRUM	AER	16	FLO	.05			N	1
14.	WOB	OMCONTROL			FHB									2
15.	WOB	ENGDINSSUR			BRQ									2
16.	WOB	ENGDINSSUR			OFF									1
17.	WOB	ENGIDINSSUR			RES									1
18.	MOSQUITOES	MEDDINSSUR												21
19.	SUBTERMS	ENGDINSSUR			WHS									3

NO	TARGET PEST NAME (a)	OPERATION				PESTICIDE							TIME HOURS (n)	
		NAME (b)	TOTAL UNITS TREATED (c)	UNIT (d)	SITE (e)	NAME (f)	FORM (g)	APPLICATION		FINAL CONC. % (j)	RATE (PER AREA UNIT)			SUPPLY SOURCE
								AMOUNT (h)	UNIT (i)		LBS. (k)	% (l)		ENTER S, N, G, C (m)
	13-15	17-19	20-24	25-27	28-30	31-33	34-36	37-41	42-43	44-49	50-55	56-58	68	69-71
20.	SUBTERMS	ENGDINSSUR			RES									33
21.	SUBTERMS	SURSOILTR	280	MSF	RES	CHLORDANE	EML	106	ZGL	1			S	10
22.	SUBTERMS	INJECTSOIL	58	CF	OFF	CHLORDANE	EML	60	ZGL	1			S	7
23.	SUBTERMS	TRNSOILTR	444	CF	RES	CHLORDANE	EML	120	ZGL	1			S	9
24.	SUBTERMS	INJECTSOIL	140	CF	RES	CHLORDANE	EML	105	ZGL	1			S	14
25.	SUBTERMS	INJECTSOIL	15	CF	RCH	CHLORDANE	EML	10	ZGL	1			S	4
26.	SUBTERMS	ENGDINSSUR			RCH									5
27.	SUBTERMS	ENGDINSSUR			UTL									1
28.	SUBTERMS	ENGDINSSUR			FHB									2
29.	SUBTERMS	ENGDINSSUR			OFF									9
30.	SAP (APHID)	EXRESIDTR	2	AC	OPG	DIAZINON	EML	20	ZGL	1			S	4

## REMARKS

## INSTRUCTIONS FOR USE

- Detailed instructions of the implementing department directive shall be used in the preparation of this report.
- Military installations shall prepare this report by the 15th day after the end of each month. The report shall be prepared and signed by the DOD certified pest management supervisor, applicator or inspector and by the installation engineer.
- Three copies shall be signed and distributed as follows:
  - Copy No. 1. To the appropriate pest management professional in accordance with implementing department directives for technical review.
  - Copy No. 2. Record to the installation surgeon.
  - Copy No. 3. Record copy to the installations engineer for two year retention in accordance with Public Law 92-516.

INSTALLATION ENGINEER  
(Reviewing Officer)INSTALLATION CERTIFIED PEST MANAGEMENT SUPERVISOR,  
APPLICATOR, OR INSPECTORTYPED NAME  
M. G. LILLEY, COL  
BASE MAINTENANCE OFFICER

SIGNATURE

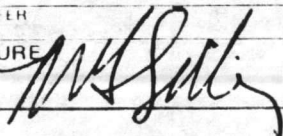

DATE (yyymmdd)

9/23/87

TYPED NAME  
MAJOR H. GRAY  
PEST CONTROL FOREMAN

SIGNATURE

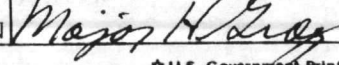

DATE (yyymmdd)

870922



PEST MANAGEMENT REPORT

CD CODE 10 25 UIC 3M 46 57 60 70 81 98 107 110 124 REPORT CONTROL SYMBOL DD-M(A&R) 1080

NAME OF MAJOR OR REVIEWING COMMAND  
 COMMANDER, ATLANTIC DIV. (10-A)  
 NAVAL FACILITIES ENGINEERING CMD

ADDRESS  
 NORFOLK, VA 23511

NAME OF REPORTING INSTALLATION  
 MARINE CORPS BASE

ADDRESS  
 CAMP LEJEUNE, NC 28542

NO	TARGET PEST	OPERATION				NAME (i)	FORM (g)	PESTICIDE			SUPPLY SOURCE ENTER S. N, G, C (m)	TIME HOURS (n)			
		NAME (a)	NAME (b)	TOTAL UNITS TREATED (c)	UNIT (d)			SITE (e)	APPLICATION				FINAL CONC. % (j)	RATE (PER AREA UNIT)	
									AMOUNT (h)	UNIT (i)				LBS. (k)	% (l)
	13-15	17-19	20-24	25-27	28-30	31-33	34-36	37-41	42-43	44-49	50-55	56-58	68	69-71	
1.	FLEAS	SPPDEQ	2	AC	OPG	DURSBAN	EML	70	ZGL	43			N	6	
2.	FLEAS	RESIDTR	1	MSF	RES	FICAM	SUS	1	ZGL	.25			C	1	
3.	FLEAS	ENGDINSSUR			OFF									1	
4.	FLEAS	RESIDTR	4	MSF	BRQ	FICAM	SUS	1	ZGL	.5			N	2	
5.	FLEAS	RESIDTR	4	MSF	OFF	FICAM	SUS	1	ZGL	.5			N	2	
6.	FLEAS	ENGDINSSUR			RES									1	
7.	FIREANTS	ENGDINSSUR			OPG									3	
8.	FIREANTS	SPPDEQ	52	AC	OPG	DURSBAN	EML	501	ZGL	.01			N	43	
9.	FIREANTS	DGHAND	332	AC	OPG	OSY (AMDRO)	BTS	153	PDW	.88			N	139	
10.	WOB	DGHAND	1	AC	OPG	CARBARYL	DUS	2	PDW	5			N	4	
11.	TICKS	MISTING	80	AC	WOO	DURSBAN	EML	400	ZGL	.01			N	15	
12.	TICKS	SPPDEQ	1	AC	OPG	DURSBAN	EML	10	ZGL	.01			N	1	
13.	TURF (Dollar Spot)	SPPDEQ	4	AC	OPG	FORE	SUS	300	ZGL	1			N	3	
14.	TURF (Dollar Spot)	SPPDEQ	4	AC	GFC	FORE	SUS	7	ZGL	1			N	6	
15.	ANTS	RESIDTR	5	MSF	BRQ	DURSBAN	EML	1	ZGL	.5			S	2	
16.	ANTS	RESIDTR	1	MSF	RES	DIAZINON	EML	1	ZGL	1			S	1	
17.	ANTS	EXRESIDTR	1	AC	OPG	DIAZINON	EML	20	ZGL	1			S	2	
18.	BIRDS	ENGDINSSUR			RES									2	
19.	BIRDS	ENGDINSSUR			RCH									3	

NO	TARGET PEST		OPERATION			PESTICIDE							TIME	
	NAME (a)	NAME (b)	TOTAL UNITS TREATED (c)	UNIT (d)	SITE (e)	NAME (f)	FORM (g)	APPLICATION		FINAL CONC. % (j)	RATE (PER AREA UNIT)		SUPPLY SOURCE	HOURS (n)
								AMOUNT (h)	UNIT (i)		LBS. (k)	% (l)	ENTER S. N, G, C (m)	
	13-15	17-19	20-24	25-27	28-30	31-33	34-36	37-41	42-43	44-49	50-55	56-58	68	69-71
20.	BIRDS	OMCONTROL	1	EA	RES									2
21.	BIRDS	DGHAND	6	MSF	EXC	ROOSTREPEL	GLU	25	PDW	2			N	15
22.	FOODPEST	ENGDINSSUR		MSF	WHS	DURSBAN	SLN		ZGL	2			N	1
23.	ANTS	RESIDTR	1	MSF	RES	DURSBAN	EML	1	ZGL	.5			N	1
24.	ANTS	RESIDTR	1	MSF	RES	DIAZINON	EML	1	ZGL	1			S	1
25.	ANTS	INBAIT	33	MSF	BRQ	COMBAT	BTS	1	PDW	.09			S	2
26.	MICE	INTRAP	32	MSF	BRQ									2
27.	MICE	INBAIT	3	MSF	WHS	TALON	BTS	9	PDW	.005			N	1
28.	MICE	EXBAIT	6	MSF	BRQ	TALON	BTS	1	PDW	.005			N	2
29.	RATS	INTRAP			BRQ									2
30.	RATS	INTRAP (GLUE)			RCH									1

REMARKS

- INSTRUCTIONS FOR USE
- Detailed instructions of the implementing department directive shall be used in the preparation of this report.
  - Military installations shall prepare this report by the 15th day after the end of each month. The report shall be prepared and signed by the DOD certified pest management supervisor, applicator or inspector and by the installation engineer.
  - Three copies shall be signed and distributed as follows:
    - Copy No. 1. To the appropriate pest management professional in accordance with implementing department directives for technical review.
    - Copy No. 2. Record to the installation surgeon.
    - Copy No. 3. Record copy to the installations engineer for two year retention in accordance with Public Law 92-516.

INSTALLATION ENGINEER  
(Reviewing Officer)

TYPED NAME: M. G. LILLEY, COL  
BASE MAINTENANCE OFFICER

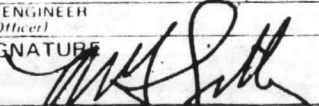
SIGNATURE: 

DATE (yyymmdd): 9/23/59

INSTALLATION CERTIFIED PEST MANAGEMENT SUPERVISOR,  
APPLICATOR, OR INSPECTOR

TYPED NAME: MAJOR H. GRAY  
PEST CONTROL FOREMAN

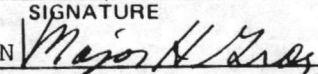
SIGNATURE: 

DATE (yyymmdd): 870922

## PEST MANAGEMENT REPORT

 CD CODE UIC  
 10 25 3M 46 57 60 70 81 88 107 110 124  
 REPORT CONTROL SYMBOL  
 DD-M(A&R) 1080

 COMMAND OR REVIEWING COMMAND  
 1ST AIRBORNE DIV. (10-A)  
 FACILITIES ENGINEERING CMD

 ADDRESS  
 NORFOLK, VA 23511

NAME OF REPORTING INSTALLATION

ADDRESS

MARINE CORPS BASE

CAMP LEJEUNE

NO.	TARGET PEST	OPERATION			PESTICIDE							TIME		
	NAME (a)	NAME (b)	TOTAL UNITS TREATED (c)	UNIT (d)	SITE (e)	NAME (f)	FORM (g)	APPLICATION		FINAL CONC. (j)	RATE (PER AREA UNIT)		SUPPLY SOURCE ENTER S, N, G, C (m)	HOURS (n)
								AMOUNT (h)	UNIT (i)		LBS. (k)	% (l)		
	13-15	17-19	20-24	25-27	28-30	31-33	34-36	37-41	42-43	44-49	50-55	56-58	68	69-71
1.	RATS	INTRAP (GLUE)			RES									1
2.	TURF (Dollar Spot)	SPPDEQ	8	AC	OPG	FORE	SUS	300	ZGL	.58			N	12
3.	MXGRABDLVD	ENGDINSSUR			OPG									2
4.	MXGRABDLVD	SPPDEQ	7	AC	OPX	GLYPHOSATE	EML	70	ZGL	1			N	13
5.	MXGRABDLVD	SPPDEQ	98	AC	OPG	GLYPHOSATE	EML	1354	ZGL	1			N	63
6.	MXGRABDLVD	SPPDEQ	135	AC	OPG	2 4 D	EML	2700	ZGL	1			N	47
7.	BDLVDWEED	SPPDEQ	253	AC	OPG	2 4 D	EML	3013	ZGL	1			N	72
8.	BDLVDWEED	ENGDINSSUR			OPG									10
9.	ROACHES	ENGDINSSUR			RES									12
10.	ROACHES	ENGDINSSUR			EXC									3
11.	ROACHES	ENGDINSSUR			FHB									3
12.	ROACHES	RESIDTR	46	MSF	BRQ	PYRETHRUM	AER	52	FLO	.25			N	3
13.	ROACHES	ENGDINSSUR			WHS									1
14.	ROACHES	RESIDTR	14	MSF	BRQ	D-PHENOTHRIN	AER	36	FLO	2			S	1
15.	ROACHES	RESIDTR	155	MSF	RES	D-PHENOTHRIN	AER	437	FLO	2			S	20
16.	ROACHES	RESIDTR	4	MSF	OFF	D-PHENOTHRIN	AER	4	FLO	2			S	1
17.	ROACHES	RESIDTR	39	MSF	RCH	PYRETHRUM	AER	96	FLO	.25			N	3
18.	ROACHES	RESIDTR	3	MSF	RES	PYRETHRUM	AER	34	FLO	.25			N	1
19.	ROACHES	RESIDTR	10	MSF	UTL	D-PHENOTHRIN	AER	4	FLO	2			S	1

NO	TARGET PEST		OPERATION			PESTICIDE							TIME														
	NAME (a)	NAME (b)	TOTAL UNITS TREATED (c)	UNIT (d)	SITE (e)	NAME (f)	FORM (g)	APPLICATION		FINAL CONC. % (j)	RATE (PER AREA UNIT)		SUPPLY SOURCE	HOURS (n)													
								AMOUNT (h)	UNIT (i)		LBS. (k)	% (l)	ENTER S, N, G, C (m)														
13-15		17-19		20-24		25-27		28-30		31-33		34-36		37-41		42-43		44-49		50-55		56-58		68		69-71	
20.	ROACHES	RESIDTR	1	MSF	WHS	PYRETHRUM	AER	6	FLO	.25				N	1												
21.	ROACHES	RESIDTR	9	MSF	WHS	D-PHENOTHRIN	AER	14	FLO	2				S	1												
22.	ROACHES	RESIDTR	168	MSF	RCH	D-PHENOTHRIN	AER	330	FLO	2				S	17												
23.	ROACHES	RESIDTR	2	MSF	IND	D-PHENOTHRIN	AER	16	FLO	2				S	1												
24.	ROACHES	RESIDTR	17	MSF	EXC	D-PHENOTHRIN	AER	38	FLO	2				S	4												
25.	ROACHES	RESIDTR	27	MSF	FHB	D-PHENOTHRIN	AER	127	FLO	2				S	10												
26.	ROACHES	RESIDTR	10	MSF	HOL	D-PHENOTHRIN	AER	16	FLO	2				S	1												
27.	ROACHES	RESIDTR	13	MCF	RES	DURSBAN	EML	78	ZGL	.1				C	7												
28.	ROACHES	RESIDTR	18	MSF	RES	OIGROWTHREG (PRECOR)	EML	121	ZGL	.1				C	9												
29.	ROACHES	RESIDTR	57	MSF	RES	DIAZINON	DUS	13	PDW	1				C	18												
30.	ROACHES	RESIDTR	6	MSF	RES	DURSBAN	EML	2	ZGL	.25				C	4												

REMARKS

- INSTRUCTIONS FOR USE
- Detailed instructions of the implementing department directive shall be used in the preparation of this report.
  - Military installations shall prepare this report by the 15th day after the end of each month. The report shall be prepared and signed by the DOD certified pest management supervisor, applicator or inspector and by the installation engineer.
  - Three copies shall be signed and distributed as follows:
    - Copy No. 1. To the appropriate pest management professional in accordance with implementing department directives for technical review.
    - Copy No. 2. Record to the installation surgeon.
    - Copy No. 3. Record copy to the installations engineer for two year retention in accordance with Public Law 92-516.

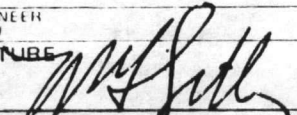
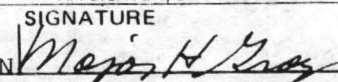
INSTALLATION ENGINEER <i>(Reviewing Officer)</i>		INSTALLATION CERTIFIED PEST MANAGEMENT SUPERVISOR, APPLICATOR, OR INSPECTOR	
TYPED NAME M. G. LILLEY, COL	SIGNATURE 	DATE (yyymmdd) 9/23/87	TYPED NAME MAJOR H. GRAY
BASE MAINTENANCE OFFICER			SIGNATURE 
			DATE (yyymmdd) 870922
		PEST CONTROL FOREMAN	

PEST MANAGEMENT REPORT

CD CODE 10 2 5 3 M 4 6 5 7 6 0 7 0 8 1 9 8 10 7 11 0 12 4  
 REPORT CONTROL SYMBOL DD-M(A&A) 1080

OF MAJOR OR REVIEWING COMMAND ADDRESS NAME OF REPORTING INSTALLATION ADDRESS  
 WANDER ATLANTIC DIV. (10-A) NORFOLK, VA 23511 MARINE CORPS BASE CAMP LEJEUNE, NC 28542  
 VAL FACILITIES ENGINEERING CMD

NO	TARGET PEST		OPERATION			PESTICIDE							TIME	
	NAME (a)	NAME (b)	TOTAL UNITS TREATED (c)	UNIT (d)	SITE (e)	NAME (f)	FORM (g)	APPLICATION		FINAL CONC. % (j)	RATE (PER AREA UNIT)			SUPPLY SOURCE ENTER S, N, G, C (m)
								AMOUNT (h)	UNIT (i)		LBS (k)	% (l)		
	13-15	17-19	20-24	25-27	28-30	31-33	34-36	37-41	42-43	44-49	50-55	56-58	68	69-71
1.	ROACHES	RESIDTR	32	MSF	RES	DURSBAN	EML	8	ZGL	1			C	8
2.	ROACHES	RESIDTR	134	MSF	RES	DURSBAN	EML	93	ZGL	.5			C	96
3.	ROACHES	RESIDTR	32	MSF	RES	PYRETHRUM	AER				3	.25	C	2
4.	ROACHES	ENGDINSSUR			BRQ									3
5.	ROACHES	ENGDINSSUR			RCH									3
6.	ROACHES	ENGDINSSUR			OFF									1
7.	ROACHES	RESIDTR	42	MSF	BRQ	DIAZINON	EML	9	ZGL	1			S	8
8.	ROACHES	RESIDTR	5	MSF	EXC	DIAZINON	EML	2	ZGL	1			S	2
9.	ROACHES	RESIDTR	3	MSF	FHB	DIAZINON	EML	2	ZGL	1			S	1
10.	ROACHES	RESIDTR	18	MSF	IND	DIAZINON	EML	3	ZGL	1			S	5
11.	ROACHES	RESIDTR	19	MSF	OFF	DIAZINON	EML	3	ZGL	1			S	2
12.	ROACHES	RESIDTR	67	MSF	RCH	DIAZINON	EML	14	ZGL	1			S	19
13.	ROACHES	RESIDTR	10	MSF	HOL	DIAZINON	EML	2	ZGL	1			S	4
14.	ROACHES	RESIDTR	13	MSF	UTL	DIAZINON	EML	2	ZGL	1			S	3
15.	ROACHES	RESIDTR	31	MSF	WHS	DIAZINON	EML	7	ZGL	1			S	10
16.	ROACHES	RESIDTR	173	MSF	RCH	DURSBAN	EML	27	ZGL	.5			N	39
17.	ROACHES	RESIDTR	12	MSF	BRQ	DURSBAN	EML	2	ZGL	.5			S	2
18.	ROACHES	RESIDTR	55	MSF	RES	DURSBAN	EML	14	ZGL	.5			N	29
19.	ROACHES	RESIDTR	95	MSF	RES	DIAZINON	EML	22	ZGL	1			S	31

NO	TARGET PEST	OPERATION				PESTICIDE							TIME HOURS (n)		
		NAME (a) 13-15	NAME (b) 17-19	TOTAL UNITS TREATED (c) 20-24	UNIT (d) 25-27	SITE (e) 28-30	NAME (f) 31-33	FORM (g) 34-36	APPLICATION		FINAL CONC. (j) 44-49	RATE (PER AREA UNIT)		SUPPLY SOURCE ENTER S, N, G, C (m) 68	
									AMOUNT (h) 37-41	UNIT (i) 42-43		LBS. (k) 50-55			% (l) 56-58
20.	ROACHES	RESIDTR	1	MSF	OFF	DURSBAN	EML	1	ZGL	.5			N	1	
21.	ROACHES	RESIDTR	3	MSF	FHB	DURSBAN	EML	1	ZGL	.5			N	1	
22.	ROACHES	RESIDTR	4	MSF	WHS	DURSBAN	EML	1	ZGL	.5			N	1	
23.	ROACHES	RESIDTR	12	MSF	EXC	DURSBAN	EML	3	ZGL	.5			N	4	
24.	ROACHES	INBAIT	569	MSF	RES	OSY (COMBAT)	BTS	2	PDW	1.65	SELF HELP		S	88	
25.	ROACHES	INBAIT	45	MSF	RCH	OSY (COMBAT)	BTS	1	PDW	1.65			S	9	
26.	ROACHES	INBAIT	26	MSF	EXC	OSY (COMBAT)	BTS	1	PDW	1.65			S	4	
27.	ROACHES	INBAIT	86	MSF	FHB	OSY (COMBAT)	BTS	10	PDW	1.65			S	57	
28.	ROACHES	INBAIT (GLUE)	1	MSF	FHB									1	
29.	ROACHES	INTRAP (GLUE)	1	MSF	WHS									1	
30.		TRAINING												2	

REMARKS

INSTRUCTIONS FOR USE

- Detailed instructions of the implementing department directive shall be used in the preparation of this report.
- Military installations shall prepare this report by the 15th day after the end of each month. The report shall be prepared and signed by the DOD certified pest management supervisor, applicator or inspector and by the installation engineer.
- Three copies shall be signed and distributed as follows:
  - Copy No. 1. To the appropriate pest management professional in accordance with implementing department directives for technical review.
  - Copy No. 2. Record to the installation surgeon.
  - Copy No. 3. Record copy to the installations engineer for two year retention in accordance with Public Law 92-516.

INSTALLATION ENGINEER  
(Reviewing Officer)

TYPED NAME  
M. G. LILLEY, COL  
BASE MAINTENANCE OFFICER

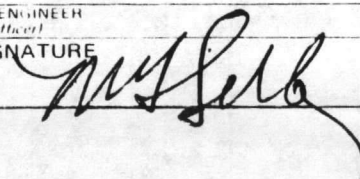
SIGNATURE  

DATE (yyymmdd)  
9/29/97

INSTALLATION CERTIFIED PEST MANAGEMENT SUPERVISOR,  
APPLICATOR, OR INSPECTOR

TYPED NAME  
MAJOR H. GRAY  
PEST CONTROL FOREMAN

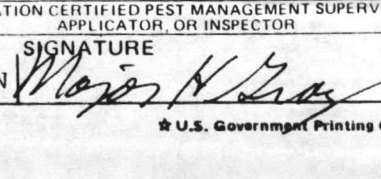
SIGNATURE  

DATE (yyymmdd)  
870922

PEST MANAGEMENT REPORT

C.D. CODE UIC 10 25 3 M 4 6 57 60 70 8 1 9 10 7 110 12 4 REPORT CONTROL SYMBOL DD-M(A&AR) 1000

REVIEWING COMMAND ADDRESS NAME OF REPORTING INSTALLATION ADDRESS  
 ATLANTIC DIV (10-A) NORFOLK, VA 23511 MARINE CORPS BASE CAMP LEJEUNE, NC 28542  
 UTILITIES ENGINEERING CMD

TIME

TARGET PEST	OPERATION					PESTICIDE							TIME	
	NAME (a)	NAME (b)	TOTAL UNITS TREATED (c)	UNIT (d)	SITE (e)	NAME (f)	FORM (g)	APPLICATION		FINAL CONC. % (j)	RATE (PER AREA UNIT)			SUPPLY SOURCE ENTER S. N, G, C (m)
								AMOUNT (h)	UNIT (i)		LBS. (k)	% (l)		
13-15	17-19	20-24	25-27	28-30	31-33	34-36	37-41	42-43	44-49	50-55	56-58	68	69-71	
1.	MAINTENANCE												7	
2.	PROGRAMMING												308	
3.	NONPROGRAM												366	
4.														
5.														
6.														
7.														
8.														
9.														
10.														
11.														
12.														
13.														
14.														
15.														
16.														
17.														
18.														
19.														

NO	TARGET PEST		OPERATION			PESTICIDE						TIME <sup>a</sup>		
	NAME (a)	NAME (b)	TOTAL UNITS TREATED (c)	UNIT (d)	SITE (e)	NAME (f)	FORM (g)	APPLICATION		FINAL CONC. % (j)	RATE (PER AREA UNIT)		SUPPLY SOURCE	HOURS (n)
								AMOUNT (h)	UNIT (i)		LBS. (k)	% (l)	ENTER S, N, G, C (m)	
	13-15	17-19	20-24	25-27	28-30	31-33	34-36	37-41	42-43	44-49	50-55	56-58	68	69-71
20.														
21.														
22.														
23.														
24.														
25.														
26.														
27.														
28.														
29.														
30.														

REMARKS

- INSTRUCTIONS FOR USE
- Detailed instructions of the implementing department directive shall be used in the preparation of this report.
  - Military installations shall prepare this report by the 15th day after the end of each month. The report shall be prepared and signed by the DOD certified pest management supervisor, applicator or inspector and by the installation engineer.
  - Three copies shall be signed and distributed as follows:
    - Copy No. 1. To the appropriate pest management professional in accordance with implementing department directives for technical review.
    - Copy No. 2. Record to the installation surgeon.
    - Copy No. 3. Record copy to the installations engineer for two year retention in accordance with Public Law 92-516.

INSTALLATION ENGINEER  
*(Reviewing Officer)*

TYPED NAME  
M. G. LILLEY, COL  
BASE MAINTENANCE OFFICER

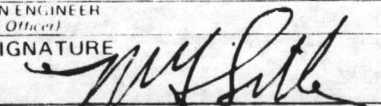
SIGNATURE  

DATE (yyymmdd)  
9/27/81

INSTALLATION CERTIFIED PEST MANAGEMENT SUPERVISOR,  
APPLICATOR, OR INSPECTOR

TYPED NAME  
MAJOR H. GRAY  
PEST CONTROL FOREMAN

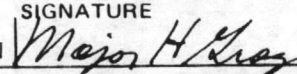
SIGNATURE  

DATE (yyymmdd)  
870922



PEST MANAGEMENT REPORT

CD CODE UIC 0 2 5 M 4 6 7 0 7 0 8 1 9 8 10 7 11 12 5  
 REPORT CONTROL SYMBOL DD-MIA&AR 1080

NAME OF MAJOR OR REVIEWING COMMAND ADDRESS NAME OF REPORTING INSTALLATION ADDRESS  
 COMMANDER, ATLANTIC DIV (10-A) NORFOLK, VA 23511 MARINE CORPS BASE CAMP LEJEUNE, NC 28542  
 NAVAL FACILITIES ENGINEERING CMD

NO	TARGET PEST NAME (a) 13-15	OPERATION			PESTICIDE							TIME HOURS (n) 69-71		
		NAME (b) 17-19	TOTAL UNITS TREATED (c) 20-24	UNIT (d) 25-27	SITE (e) 28-30	NAME (f) 31-33	FORM (g) 34-36	APPLICATION		FINAL CONC. % (j) 44-49	RATE (PER AREA UNIT)		SUPPLY SOURCE ENTER S. N, G, C (m) 68	
								AMOUNT (h) 37-41	UNIT (i) 42-43		LBS (k) 50-55			% (l) 56-58
1.	MOSQUITOES	FOGGING	130	AC	OPG	MALATHION	SLN	10	ZGL	95			S	4
2.	MOSQUITOES	FOGGING	40	AC	WOO	MALATHION	SLN	2	ZGL	95			S	4
3.	MOSQUITOES	ENGDINSSUR			IMP									4
4.	TICKS	MISTING	5	AC	WOO	DURSBAN	EML	100	ZGL	.01			N	4
5.	TICKS	SPPDEQ	30	AC	OPG	DURSBAN	EML	503	ZGL	.01			N	27
6.	TICKS	SPPDEQ	21	AC	WOO	DURSBAN	EML	75	ZGL	.01			N	6
7.	TICKS	MISTING	38	AC	OPG	DURSBAN	EML	420	ZGL	.01			N	6
8.	WOB	SPCTR	8	MCF	BRQ	PYRETHRUM	AER	64	FLO	.05			N	2
9.	WOB	SPCTR	1	MCF	OFF	PYRETHRUM	AER	8	FLO	.05			N	1
10.	WOB	EXRESIDTR	1	AC	OPG	DURSBAN	EML	10	ZGL	.01			N	1
11.	WOB	EXRESIDTR	84	MSF	RES	PYRETHRUM	AER	49	FLO	.05			N	10
12.	WOB	SPCTR	29	MCF	UTL	PYRETHRUM	AER	84	FLO	.05			N	6
13.	WOB	SPCTR	1	MCF	WHS	PYRETHRUM	AER	16	FLO	.05			N	1
14.	WOB	SPCTR	1	MSF	RCH	PYRETHRUM	AER	1	FLO	.05			N	1
15.	WOB	ENGDINSSUR			UTL									2
16.	WOB	ENGDINSSUR			OFF									6
17.	WOB	ENGDINSSUR			RES									3
18.	MOSQUITOES	MEDDINSSUR												104
19.	SUBTERMS	ENGDINSSUR			UTL									1

NO	TARGET PEST NAME (a)	OPERATION				PESTICIDE							TIME	
		NAME (b)	TOTAL UNITS TREATED (c)	UNIT (d)	SITE (e)	NAME (f)	FORM (g)	APPLICATION		FINAL CONC. % (j)	RATE (PER AREA UNIT)		SUPPLY SOURCE ENTER S, N, G, C (m)	HOURS (n)
								AMOUNT (h)	UNIT (i)		LBS. (k)	% (l)		
	13-15	17-19	20-24	25-27	28-30	31-33	34-36	37-41	42-43	44-49	50-55	56-58	68	69-71
20.	SUBTERMS	ENGDINSSUR			RES									1
21.	SUBTERMS	ENGDINSSUR			OFF									1
22.	SUBTERMS	INJECTSOIL	150	CT	RES	CHLORDANE	EML	50	ZGL	1			S	2
23.	SUBTERMS	TRNSOILTR	264	CT	RES	CHLORDANE	EML	50	ZGL	1			S	4
24.	SPIDERS	RESIDTR	3	MSF	RES	DURSBAN	EML	1	ZGL	.5			N	1
25.	TICKS	DGPEQ	38	AC	WOO	DIAZINON	DUS	75	PDW	2			S	6
26.	TICKS	ENGDINSSUR			OPG									2
27.	FILTHFLIES	RESIDTR	24	MCF	RCH	D-PHENOTHRIN	AER	24	FLO	2			S	1
28.	FILTHFLIES	RESIDTR	9	AC	LDF	DIMETHOATE	EML	90	ZGL	1			N	6
29.	FILTHFLIES	RESIDTR	440	MSF	KEN	DIMETHOATE	EML	165	ZGL	1			N	18
30.	WOO	ENGDINSSUR			UTL									1

## REMARKS

## INSTRUCTIONS FOR USE

- Detailed instructions of the implementing department directive shall be used in the preparation of this report.
- Military installations shall prepare this report by the 15th day after the end of each month. The report shall be prepared and signed by the DOD certified pest management supervisor, applicator or inspector and by the installation engineer.
- Three copies shall be signed and distributed as follows:
  - Copy No. 1. To the appropriate pest management professional in accordance with implementing department directives for technical review.
  - Copy No. 2. Record to the installation surgeon.
  - Copy No. 3. Record copy to the installations engineer for two year retention in accordance with Public Law 92-516.

INSTALLATION ENGINEER  
(Reviewing Officer)TYPED NAME  
M. G. LILLEY COL  
BASE MAINTENANCE OFFICER

SIGNATURE

DATE (yyymmdd)

INSTALLATION CERTIFIED PEST MANAGEMENT SUPERVISOR,  
APPLICATOR, OR INSPECTORTYPED NAME  
MAJOR H. GRAY  
PEST CONTROL FOREMAN

SIGNATURE

DATE (yyymmdd)

87 09 24

## PEST MANAGEMENT REPORT

CD CODE	UIC	1	2	3	4	5	6	7	8	9	10	11	12	13	14	15	REPORT CONTROL SYMBOL	
0	2	5	3	M	4	6	7	6	0	7	0	8	1	9	8	10	7	DD-M(A&B)R 1000

 NAME OF MAJOR OR REVIEWING COMMAND  
 COMMANDER, ATLANTIC DIV (10-A)  
 NAVAL FACILITIES ENGINEERING CMD

 ADDRESS  
 NORFOLK, VA 23511

 NAME OF REPORTING INSTALLATION  
 MARINE CORPS BASE

 ADDRESS  
 CAMP LEJEUNE, NC 28542

NO	TARGET PEST NAME (a)	OPERATION				PESTICIDE								TIME HOURS (n)
		NAME (b)	TOTAL UNITS TREATED (c)	UNIT (d)	SITE (e)	NAME (f)	FORM (g)	APPLICATION		FINAL CONC. (j)	RATE (PER AREA UNIT)		SUPPLY SOURCE ENTER S, N, G, C (m)	
								AMOUNT (h)	UNIT (i)		LBS. (k)	% (l)		
	13-15	17-19	20-24	25-27	28-30	31-33	34-36	37-41	42-43	44-49	50-55	56-58	68	69-71
1.	WOO	ENGDINSSUR			OPG									1
2.	WOO	DGHAND	1	AC	OPG	CARBARYL	DUS	1	PDW	5			S	3
3.	URTICATING	ENGDINSSUR			OPG									1
4.	FLEAS	RESIDTR	1	MSF	RES	DURSBAN	EML	1	ZGL	.5			N	1
5.	FLEAS	RESIDTR	1	MSF	RES	DURSBAN	EML	1	ZGL	.5			C	1
6.	FLEAS	RESIDTR	1	MSF	RES	FICAM	SUS	1	ZGL	.25			N	1
7.	ROO GRUB	SPPDEQ	14	AC	OPG	DURSBAN	EML	625	ZGL	.01			N	17
8.	SLVRSOCID	RESIDTR	1	MSF	RES	DURSBAN	EML	1	ZGL	.5			N	1
9.	SNKES	OMCONTROL	1	MSF	EXC									2
10.	SNKES	ENGDINSSUR			RES									3
11.	FIREANTS	ENGDINSSUR			OPG									3
12.	FIREANTS	SPPDEQ	77	AC	OPG	DURSBAN	EML	332	ZGL	.01			N	20
13.	FIREANTS	DGHAND	121	AC	OPG	OSY (AMDRO)	BTS	726	EA	.88	SELF HELP		N	10
14.	FIREANTS	DGHAND	31	AC	OPG	OSY (AMDRO)	BTS	1	PDW	.88			N	12
15.	PSYCHODA	SPPDEQ	1	AC	OPG	DURSBAN	EML	15	ZGL	.01			N	1
16.	PSYCHODA	RESIDTR	1	MSF	RES	DIAZINON	EML	1	ZGL	1			S	1
17.	PSYCHODA	RESIDTR	1	MCF	RES	D-PHENOTHRIN	AER	24	FLO	2			S	1
18.	PSYCHODA	ENGDINSSUR			RES									1
19.	OTP (DOG)	DGHAND	1	MSF	RES	OLP ULV	EML	1	ZGL	NA			N	1

NO	TARGET PEST NAME (a)	OPERATION				PESTICIDE								TIME HOURS (n)
		NAME (b)	TOTAL UNITS TREATED (c)	UNIT (d)	SITE (e)	NAME (f)	FORM (g)	APPLICATION		FINAL CONC. % (j)	RATE (PER AREA UNIT)		SUPPLY SOURCE ENTER S, N, G, C (m)	
								AMOUNT (h)	UNIT (i)		LBS. (k)	% (l)		
	13-15	17-19	20-24	25-27	28-30	31-33	34-36	37-41	42-43	44-49	50-55	56-58	68	69-71
20.	ANTS	ENGDINSSUR			RES									1
21.	ANTS	RESIDTR	4	MSF	RES	DURSBAN	EML	1	ZGL	.5			N	1
22.	BIRDS	OMCONTROL	2	EA	RES									2
23.	BIRDS	ENGDINSSUR			RES									1
24.	BIRDS	ENGDINSSUR			OFF									3
25.	BIRDS	OMCONTROL	3	EA	OFF									4
26.	EARWIGS	ENGDINSSUR			RES									2
27.	MITES	SPPDEQ	1	AC	OPG	DIAZINON	EML	100	ZGL	.11			S	4
28.	MITES	SPPDEQ	1	AC	OPG	DIMETHOATE	EML	100	ZGL	.06			N	7
29.	MICE	ENGDINSSUR			WHS									2
30.	BDLVDWEED	SPPDEQ	775	AC	OPG	2 4 D	EML	7300	ZGL	1			N	154

## REMARKS

## INSTRUCTIONS FOR USE

- Detailed instructions of the implementing department directive shall be used in the preparation of this report.
- Military installations shall prepare this report by the 15th day after the end of each month. The report shall be prepared and signed by the DOD certified pest management supervisor, applicator or inspector and by the installation engineer.
- Three copies shall be signed and distributed as follows:
  - Copy No. 1. To the appropriate pest management professional in accordance with implementing department directives for technical review.
  - Copy No. 2. Record to the installation surgeon.
  - Copy No. 3. Record copy to the installations engineer for two year retention in accordance with Public Law 92-516.

INSTALLATION ENGINEER  
(Reviewing Officer)

SIGNATURE

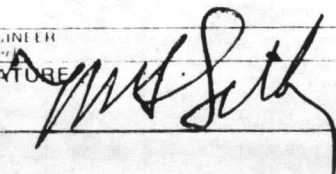

DATE (yyymmdd)

TYPED NAME  
M. G. LILLEY, COL  
BASE MAINTENANCE OFFICERINSTALLATION CERTIFIED PEST MANAGEMENT SUPERVISOR,  
APPLICATOR, OR INSPECTOR

SIGNATURE

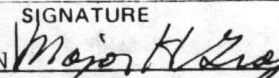
TYPED NAME  
MAJOR H. GRAY  
PEST CONTROL FOREMAN

DATE (yyymmdd)

870924

<b>PEST MANAGEMENT REPORT</b>										CD CODE UIC 0 2 5 3 M 4 6 5 7 0 7 0 8 1 9 8 107 10 125					REPORT CONTROL SYMBOL DD-M(A&R) 1080				
NAME OF MAJOR OR REVIEWING COMMAND COMMANDER, ATLANTIC DIV. (10-A) NAVAL FACILITIES ENGINEERING CMD					ADDRESS NORFOLK, VA 23411					NAME OF REPORTING INSTALLATION MARINE CORPS BASE					ADDRESS CAMP LEJEUNE, NC 28542				

NO	TARGET PEST NAME (a)	OPERATION				NAME (f)	FORM (g)	PESTICIDE			RATE (PER AREA UNIT)		SUPPLY SOURCE ENTER S, N, G, C (m)	TIME HOURS (n)
		NAME (b)	TOTAL UNITS TREATED (c)	UNIT (d)	SITE (e)			APPLICATION		FINAL CONC. % (j)	LBS (k)	% (l)		
								AMOUNT (h)	UNIT (i)					
	13-15	17-19	20-24	25-27	28-30	31-33	34-36	37-41	42-43	44-49	50-55	56-58	68	69-71
1.	BDLVDWEED	ENGDINSSUR			OPG									3
2.	MXGRABDLVD	SPPDEQ	26	AC	OPG	2 4 D	EML	1200	ZGL	1			N	15
3.	MXGRABDLVD	SPPDEQ	5	AC	GFG	SURFLAN	EML	2	ZGL	.5			S	2
4.	MXGRABDLVD	SPHAND	2	AC	OPG	DIQUAT	EML	8	ZGL	1			N	8
5.	MXGRABDLVD	SPPDEQ	72	AC	OPG	KERB	SUS	800	ZGL	.27			N	7
6.	MXGRABDLVD	ENGDINSSUR			OBG									2
7.	MICE	INBAIT	48	MSF	WHS	TALON	BTS	4	PDW	.005			N	2
8.	MICE	ENGDINSSUR												1
9.	GRASSYWEED	SPPDEQ	3	AC	OPG	POAST	EML	1	ZGL	1			N	7
10.	GRASSYWEED	SPPDEQ	40	AC	OPG	OUST	SUS	400	ZGL	.5			N	8
11.	RATS	INBAIT	8	MSF	OFF	TALON	BTS	2	PDW	.005			N	1
12.	TURF (Dollar Spot)	SPPDEQ	7	AC	GFG	FORE	SUS	650	ZGL		1		N	6
13.	MXGRABDLVD	SPPDEQ		AC	OPB	GLYPHOSATE	EML	160	ZGL	1	2640		N	95
14.	MXGRABDLVD	SPPDEQ	15	AC	OPG	GLYPHOSATE	EML	164	ZGL	1			N	14
15.	MXGRABDLVD	SPPDEQ	84	AC	OPG	SURFLAN	EML	1600	ZGL	1			N	11
16.	ROACHES	ENGDINSSUR			RES									56
17.	ROACHES	ENGDINSSUR			EXC									1
18.	ROACHES	ENGDINSSUR			FHB									2
19.	ROACHES	ENGDINSSUR			RCH									1

NO	TARGET PEST		OPERATION			PESTICIDE							TIME HOURS (n)	
	NAME (a) 13-15	NAME (b) 17-19	TOTAL UNITS TREATED (c) 20-24	UNIT (d) 25-27	SITE (e) 28-30	NAME (f) 31-33	FORM (g) 34-36	APPLICATION		FINAL CONC. % (j) 44-49	RATE (PER AREA UNIT)			SUPPLY SOURCE ENTER S, N, G, C (m) 68
								AMOUNT (h) 37-41	UNIT (i) 42-43		LBS (k) 50-55	% (l) 56-58		
20.	ROACHES	RESIDTR	70	MSF	EXC	D-PHENOTHRIN	AER	56	FLO	2			S	3
21.	ROACHES	RESIDTR	150	MSF	FHB	D-PHENOTHRIN	AER	210	FLO	2			N	14
22.	ROACHES	RESIDTR	9	MSF	OFF	D-PHENOTHRIN	AER	30	FLO	2			S	1
23.	ROACHES	RESIDTR	238	MSF	RES	D-PHENOTHRIN	AER	497	FLO	2			S	21
24.	ROACHES	RESIDTR	36	MSF	UTL	D-PHENOTHRIN	AER	34	FLO	2			S	2
25.	ROACHES	RESIDTR	43	MSF	BRQ	D-PHENOTHRIN	AER	60	FLO	2			S	3
26.	ROACHES	RESIDTR	23	MSF	WHS	D-PHENOTHRIN	AER	61	FLO	2			S	2
27.	ROACHES	RESIDTR	114	MSF	RCH	D-PHENOTHRIN	AER	144	FLO	2			S	4
28.	ROACHES	RESIDTR	2	MSF	IND	D-PHENOTHRIN	AER	8	FLO	2			S	1
29.	ROACHES	RESIDTR	34	MSF	RES	DIAZINON	DUS	4	DUS	1			C	14
30.	ROACHES	RESIDTR	8	MSF	RES	FICAM	DUS	2	PDW	1			N	1

REMARKS

INSTALLATION ENGINEER  
(Reviewing Officer)

TYPED NAME  
M. G. LILLEY, COL  
BASE MAINTENANCE OFFICER

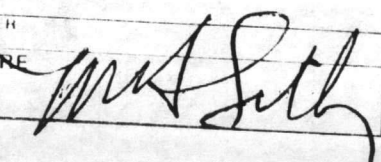
SIGNATURE 

DATE (yyymmdd)

INSTRUCTIONS FOR USE

- Detailed instructions of the implementing department directive shall be used in the preparation of this report.
- Military installations shall prepare this report by the 15th day after the end of each month. The report shall be prepared and signed by the DOD certified pest management supervisor, applicator or inspector and by the installation engineer.
- Three copies shall be signed and distributed as follows:
  - Copy No. 1. To the appropriate pest management professional in accordance with implementing department directives for technical review.
  - Copy No. 2. Record to the installation surgeon.
  - Copy No. 3. Record copy to the installations engineer for two year retention in accordance with Public Law 92-516.

INSTALLATION CERTIFIED PEST MANAGEMENT SUPERVISOR,  
APPLICATOR, OR INSPECTOR

TYPED NAME  
MAJOR H. GRAY  
PEST CONTROL FOREMAN

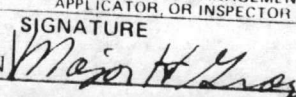
SIGNATURE 

DATE (yyymmdd)  
870924

<b>PEST MANAGEMENT REPORT</b>						C.D. CODE 10125 UIC 3M 46 57 60 70 81 98 107 110 125					REPORT CONTROL SYMBOL DD-M(ABAR) 1080	
NAME OF MAJOR OR REVIEWING COMMAND COMMANDER, ATLANTIC DIV. (IC-A) NAVAL FACILITIES ENGINEERING CMD			ADDRESS NORFOLK, VA 23511			NAME OF REPORTING INSTALLATION MARINE CORPS BASE					ADDRESS CAMP LEJEUNE, NC 28542	

NO.	TARGET PEST		OPERATION			PESTICIDE							TIME	
	NAME (a)	NAME (b)	TOTAL UNITS TREATED (c)	UNIT (d)	SITE (e)	NAME (f)	FORM (g)	APPLICATION		FINAL CONC. (j)	RATE (PER AREA UNIT)		SUPPLY SOURCE ENTER S, N, G, C (m)	HOURS (n)
								AMOUNT (h)	UNIT (i)		LBS. (k)	% (l)		
	13-15	17-19	20-24	25-27	28-30	31-33	34-36	37-41	42-43	44-49	50-55	56-58	68	69-71
1.	ROACHES	RESIDTR	35	MSF	RES	DURSBAN	EML	9	ZGL	.5			C	15
2.	ROACHES	RESIDTR	5	MSF	RES	DURSBAN	EML	1	ZGL	.25			C	3
3.	ROACHES	RESIDTR	28	MSF	BRQ	DIAZINON	EML	7	ZGL	1			S	8
4.	ROACHES	RESIDTR	5	MSF	IND	DIAZINON	EML	1	ZGL	1			S	2
5.	ROACHES	RESIDTR	22	MSF	OFF	DIAZINON	EML	6	ZGL	1			S	10
6.	ROACHES	RESIDTR	2	MSF	RCH	DIAZINON	EML	1	ZGL	1			S	1
7.	ROACHES	RESIDTR	57	MSF	RES	DIAZINON	EML	22	ZGL	1			S	22
8.	ROACHES	RESIDTR	1	MSF	UTL	DIAZINON	EML	1	ZGL	1			S	1
9.	ROACHES	RESIDTR	18	MSF	WHS	DIAZINON	EML	5	ZGL	1			S	5
10.	ROACHES	RESIDTR	24	MSF	WHS	DURSBAN	EML	2	ZGL	.5			N	3
11.	ROACHES	RESIDTR	27	MSF	RES	DURSBAN	EML	8	ZGL	1			C	7
12.	ROACHES	RESIDTR	67	MSF	RES	DURSBAN	EML	14	ZGL	.5			N	21
13.	ROACHES	RESIDTR	42	MSF	BRQ	DURSBAN	EML	7	ZGL	.5			N	4
14.	ROACHES	RESIDTR	148	MSF	RCH	DURSBAN	EML	67	ZGL	.5			N	25
15.	ROACHES	RESIDTR	16	MSF	OFF	DURSBAN	EML	2	ZGL	.5			N	3
16.	ROACHES	RESIDTR	45	MSF	UTL	DURSBAN	EML	3	ZGL	.5			N	3
17.	ROACHES	INBAIT	546	MSF	RES	OSY (COMBAT)	BTS	21	PDW	1.65	SELF	HELP	S	88
18.	ROACHES	INBAIT	300	MSF	BRQ	OSY (COMBAT)	BTS	3	PLW	1.65	SELF	HELP	S	6
19.	ROACHES	RESIDTR	24	MSF	EXC	DURSBAN	EML	2	ZGL	.5			N	2

NO	TARGET PEST	OPERATION				PESTICIDE							TIME		
		NAME (a)	NAME (b)	TOTAL UNITS TREATED (c)	UNIT (d)	SITE (e)	NAME (f)	FORM (g)	APPLICATION		FINAL CONC. % (j)	RATE (PER AREA UNIT)		SUPPLY SOURCE	HOURS (n)
									AMOUNT (h)	UNIT (i)		LBS. (k)	% (l)	ENTER S. N, G, C (m)	
13-15	17-19	20-24	25-27	28-30	31-33	34-36	37-41	42-43	44-49	50-55	56-58	68	69-71		
20.	ROACHES	INBAIT	2	MSF	BRQ	OSY (COMBAT)	BTS	1	PDW	1.65			S	1	
21.	ROACHES	INBAIT	43	MSF	EXC	OSY (COMBAT)	BTS	1	PDW	1.65			S	3	
22.	ROACHES	INBAIT	85	MSF	RCH	OSY (COMBAT)	BTS	4	PDW	1.65			S	16	
23.	ROACHES	INBAIT	7	MSF	OFF	OSY (COMBAT)	BTS	1	PDW	1.65			S	3	
24.	ROACHES	INBAIT	123	MSF	FHB	OSY (COMBAT)	BTS	3	PDW	1.65			S	19	
25.	ROACHES	INBAIT (GLUE)		MSF	FHB									1	
26.	ROACHES	INTRAP (GLUE)		MSF	RCH									1	
27.		MAINTENANCE												64	
28.		PROGRAMMING												225	
29.		NONPROGRAM												583	
30.															

## REMARKS

## INSTRUCTIONS FOR USE

- Detailed instructions of the implementing department directive shall be used in the preparation of this report.
- Military installations shall prepare this report by the 15th day after the end of each month. The report shall be prepared and signed by the DOD certified pest management supervisor, applicator or inspector and by the installation engineer.
- Three copies shall be signed and distributed as follows:
  - Copy No. 1. To the appropriate pest management professional in accordance with implementing department directives for technical review.
  - Copy No. 2. Record to the installation surgeon.
  - Copy No. 3. Record copy to the installations engineer for two year retention in accordance with Public Law 92-516.

INSTALLATION ENGINEER  
(Reviewing Officer)TYPED NAME  
M. G. LILLEY, COL  
BASE MAINTENANCE OFFICER

SIGNATURE

DATE (yyymmdd)

INSTALLATION CERTIFIED PEST MANAGEMENT SUPERVISOR,  
APPLICATOR, OR INSPECTORTYPED NAME  
MAJOR H. GRAY  
PEST CONTROL FOREMAN

SIGNATURE

DATE (yyymmdd)

270924



PEST MANAGEMENT REPORT

C.D. CODE UIC 10 2 5 3 M 4 6 5 7 6 0 7 0 8 1 9 8 107 110 128  
 REPORT CONTROL SYMBOL DD-M(A&R) 1080

NAME OF MAJOR OR REVIEWING COMMAND: COMMANDER, ATLANTIC DIV (10-A) NAVAL FACILITIES ENGINEERING CMD  
 ADDRESS: NORFOLK, VA 23511  
 NAME OF REPORTING INSTALLATION: MARINE CORPS BASE  
 ADDRESS: CAMP LEJEUNE, NC 28542

NO	TARGET PEST NAME (a)	OPERATION			PESTICIDE							TIME HOURS (n)		
		NAME (b)	TOTAL UNITS TREATED (c)	UNIT (d)	SITE (e)	NAME (f)	FORM (g)	APPLICATION		FINAL CONC. % (j)	RATE (PER AREA UNIT)		SUPPLY SOURCE ENTER S, N, G, C (m)	
								AMOUNT (h)	UNIT (i)		LBS. (k)			% (l)
13-15		17-19	20-24	25-27	28-30	31-33	34-36	37-41	42-43	44-49	50-55	56-58	68	69-71
1.	MOSQUITOES	FOGGING	1225	AC	OPG	MALATHION	SLN	67	ZGL	95			S	40
2.	MOSQUITOES	FOGGING	1120	AC	WOO	MALATHION		28	ZGL	95			S	33
3.	MOSQUITOES	ENGDINSSUR			IMP									3
4.	MOSQUITOES	SPHAND	80	AC	IMP	FLITMO	SLN	205	ZGL	98.5			N	201
5.	MOSQUITOES	SPPDEQ	4	AC	OPG	DURSBAN	EML	225	ZGL	.01			N	6
6.	TICKS	SPPDEQ	5	AC	WOO	MALATHION	EML	250	ZGL	1			S	8
7.	TICKS	ENGDINSSUR			OPG									2
8.	WOB	SPCTR	8	MCF	BRQ	PYRETHRUM	AER	32	FLO	.05			N	2
9.	WOB	SPCTR	3	MCF	OFF	PYRETHRUM	AER	16	FLO	.05			N	1
10.	WOB	EXRESIDTR	30	MSF	OPG	PYRETHRUM	AER	161	FLO	.05			N	5
11.	WOB	EXRESIDTR	16	MSF	RES	PYRETHRUM	AER	130	FLO	.05			N	21
12.	WOB	SPCTR	14	MCF	UTL	PYRETHRUM	AER	57	FLO	.05			N	2
13.	WOB	SPCTR	9	MCF	IND	PYRETHRUM	AER	42	FLO	.05			N	8
14.	WOB	RESIDTR	2	MSF	RCH	PYRETHRUM	AER	16	FLO	.05			N	2
15.	WOB	SPCTR	5	MCF	TRE	PYRETHRUM	AER	18	FLO	.05			N	2
16.	WOB	ENGDINSSUR			BRQ									2
17.	WOB	ENGDINSSUR			OPG									1
18.	MOSQUITOES	MEDDINSSUR												126
19.	SUBTERMS	ENGDINSSUR			OFF									2

NO.	TARGET PEST		OPERATION			PESTICIDE							TIME	
	NAME (a)	NAME (b)	TOTAL UNITS TREATED (c)	UNIT (d)	SITE (e)	NAME (f)	FORM (g)	APPLICATION		FINAL CONC. % (j)	RATE (PER AREA UNIT)		SUPPLY SOURCE ENTER S, N, G, C (m)	HOURS (n)
								AMOUNT (h)	UNIT (i)		LBS (k)	% (l)		
	13-15	17-19	20-24	25-27	28-30	31-33	34-36	37-41	42-43	44-49	50-55	56-58	68	69-71
20.	SUBTERMS	ENGDINSSUR			RES									3
21.	SUBTERMS	SURSOILTR	7	MSF	RES	DURSBAN	EML	25	ZGL	1			N	6
22.	SUBTERMS	ENGDINSSUR			IND									2
23.	SUBTERMS	ENGDINSSUR			BRQ									5
24.	SPIDERS	EXRESIDTR	1	MSF	BRQ	PYRETHRUM	AER	8	FLO	.05			N	2
25.	SPIDERS	ENGDINSSUR			BRQ									1
26.	FILTHFLIES	SPCTR	1	MCF	FHB	PYRETHRUM	AER	140	FLO	.05			N	2
27.	FILTHFLIES	STEAMCLEAN	41	EA	TGC									102
28.	FILTHFLIES	RESIDTR	6	AC	LDF	MALATHION	EML	90	ZGL	1			N	6
29.	FILTHFLIES	RESIDTR	70	MSF	KEN	MALATHION	EML	185	ZGL	1			N	17
30.	FILTHFLIES	EXRESIDTR	41		KEN	DIMETHOATE	EML	150	ZGL	1			N	8

## REMARKS

## INSTRUCTIONS FOR USE

- Detailed instructions of the implementing department directive shall be used in the preparation of this report.
- Military installations shall prepare this report by the 15th day after the end of each month. The report shall be prepared and signed by the DOD certified pest management supervisor, applicator or inspector and by the installation engineer.
- Three copies shall be signed and distributed as follows:
  - Copy No. 1. To the appropriate pest management professional in accordance with implementing department directives for technical review.
  - Copy No. 2. Record to the installation surgeon.
  - Copy No. 3. Record copy to the installations engineer for two year retention in accordance with Public Law 92-516.

INSTALLATION ENGINEER  
(Reviewing Officer)INSTALLATION CERTIFIED PEST MANAGEMENT SUPERVISOR,  
APPLICATOR, OR INSPECTOR

TYPED NAME

SIGNATURE

DATE (yyymmdd)

TYPED NAME

SIGNATURE

DATE (yyymmdd)

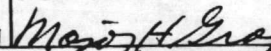
M. G. LILLEY, COL  
BASE MAINTENANCE OFFICERMAJOR H. GRAY  
PEST CONTROL FOREMAN

871125

PEST MANAGEMENT REPORT

CD CODE UIC 101253M465760708198107110128 REPORT CONTROL SYMBOL DD-M(A&AR) 1080

NAME OF MAJOR OR REVIEWING COMMAND ADDRESS NAME OF REPORTING INSTALLATION ADDRESS  
 COMMANDER, ATLANTIC DIV. (10-A) NORFOLK, VA 23511 MARINE CORPS BASE CAMP LEJEUNE, NC 28542  
 NAVAL FACILITIES ENGINEERING CMD

NO	TARGET PEST NAME (a) 13-15	OPERATION			PESTICIDE							TIME HOURS (n) 69-71		
		NAME (b) 17-19	TOTAL UNITS TREATED (c) 20-24	UNIT (d) 25-27	SITE (e) 28-30	NAME (f) 31-33	FORM (g) 34-36	APPLICATION		FINAL CONC. % (j) 44-49	RATE (PER AREA UNIT)		SUPPLY SOURCE ENTER S, N, G, C (m) 68	
								AMOUNT (h) 37-41	UNIT (i) 42-43		LBS. (k) 50-55			% (l) 56-58
1.	FILTHFLIES	SPCTR	1	MCF	RCH	PYRETHRUM	AER	10	FLO	.25			N	1
2.	FLEAS	SPPDEQ	6	AC	OPG	DURSBAN	EML	221	ZGL	.01			N	7
3.	FLEAS	SPCTR	27	MCF	RES	PYRETHRUM	AER	42	FLO	.25			N	1
4.	FLEAS	RESIDTR	1	AC	OPG	DURSBAN	EML	20	ZGL	.01			N	1
5.	FLEAS	SPCTR	1	MCF	RES	PYRETHRUM	AER	12	FLO	.25			N	1
6.	FLEAS	RESIDTR	16	MSF	RES	DURSBAN	EML	8	ZGL	.5			N	11
7.	FLEAS	RESIDTR	6	MSF	RCH	FICAM	SUS	2	ZGL	.5			N	3
8.	FLEAS	RESIDTR	1	MSF	RES	DURSBAN		1	ZGL	.5			C	1
9.	FLEAS	RESIDTR	6	MSF	RES	FICAM	SUS	4	ZGL	.5			N	4
10.	FLEAS	ENGDINSSUR			RES									1
11.	FIREANTS	ENGDINSSUR			WHS									1
12.	FIREANTS	SPPDEQ	201	AC	OPG	DURSBAN	EML	1283	ZGL	.01			N	86
13.	FIREANTS	DGHAND (SELFHELP)	261	MSF	RES	OSY (AMDRO)	BTS	48	PDW	.88			N	10
14.	FLEAS	SPPDEQ	1	AC	OPG	MALATHION	EML	25	ZGL	1			S	1
15.	ANTS	INBAIT	1	MSF	FHB	OSY (COMBAT)	BTS	1	PDW	.88			N	1
16.	ANTS	INBAIT	1	MSF	OFF	OSY (COMBAT)	BTS	1	PDW	.88			N	1
17.	ANTS	RESIDTR	2	MSF	UTL	DURSBAN	EML	1	ZGL	.01			N	1
18.	ANTS	RESIDTR	24	MSF	BRQ	DURSBAN	EML	3	ZGL	.5			N	2
19.	ANTS	INBAIT	6	MSF	FHB	OSY (AMDRO)	BTS	1	PDW	.88			N	3

NO	TARGET PEST		OPERATION			PESTICIDE							TIME	
	NAME (a)	NAME (b)	TOTAL UNITS TREATED (c)	UNIT (d)	SITE (e)	NAME (f)	FORM (g)	APPLICATION		FINAL CONC. % (j)	RATE (PER AREA UNIT)		SUPPLY SOURCE ENTER S, N, G, C (m)	HOURS (n)
								AMOUNT (h)	UNIT (i)		LBS. (k)	% (l)		
	13-15	17-19	20-24	25-27	28-30	31-33	34-36	37-41	42-43	44-49	50-55	56-58	68	69-71
20.	ANTS	RESIDTR	1	MSF	RCH	DIAZINON	EML	2	ZGL	1			S	1
21.	ANTS	RESIDTR	4	MSF	RES	DIAZINON	EML	3	ZGL	1			S	2
22.	ANTS	EXRESIDTR	2	AC	OPG	DURSBAN	EML	20	ZGL	.01			N	2
23.	MXGRABDLVD	ENGDINSSUR			RES									2
24.	SNKES	ENGDINSSUR			RES									1
25.	FOODPEST	ENGDINSSUR			WHS									5
26.	FOODPEST	SPCTR	316	MCF	WHS	DCHLORVOS	SLN	50	ZGL	5.62			N	7
27.	MOSQUITOES	DGHAND	11	AC	WOO	BACTIMOS	BQT	4	PDW	10			N	29
28.	EARWIGS	SPPDEQ	2	AC	OPG	DURSBAN	EML	40	ZGL	.01			N	2
29.	STOMOXYS	SPPDEQ	7	AC	OPG	MALATHION	EML	125	ZGL	1			S	8
30.	ROO (CUTWORMS)	SPPDEQ	2	AC	GFG	CARBARYL	SUS	6	ZGL	.12				5

## REMARKS

## INSTRUCTIONS FOR USE

- Detailed instructions of the implementing department directive shall be used in the preparation of this report.
- Military installations shall prepare this report by the 15th day after the end of each month. The report shall be prepared and signed by the DOD certified pest management supervisor, applicator or inspector and by the installation engineer.
- Three copies shall be signed and distributed as follows:
  - Copy No. 1. To the appropriate pest management professional in accordance with implementing department directives for technical review.
  - Copy No. 2. Record to the installation surgeon.
  - Copy No. 3. Record copy to the installations engineer for two year retention in accordance with Public Law 92-516.

INSTALLATION ENGINEER  
(Reviewing Officer)TYPED NAME  
M. G. LILLEY, COL  
BASE MAINTENANCE OFFICER

SIGNATURE

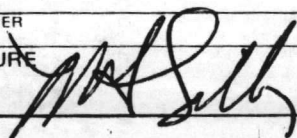

DATE (yyymmdd)

12/1/57

INSTALLATION CERTIFIED PEST MANAGEMENT SUPERVISOR,  
APPLICATOR, OR INSPECTORTYPED NAME  
MAJOR H. GRAY  
PEST CONTROL FOREMAN

SIGNATURE

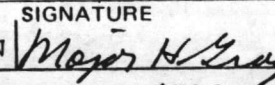

DATE (yyymmdd)

87 11 25

PEST MANAGEMENT REPORT													C.D. CODE UIC				REPORT CONTROL SYMBOL											
NAME OF MAJOR OR REVIEWING COMMAND COMMANDER, ATLANTIC DIV. (10-A) NAVAL FACILITIES ENGINEERING CMD													ADDRESS NORFOLK, VA 23511				NAME OF REPORTING INSTALLATION MARINE CORPS BASE				ADDRESS CAMP LEJEUNE, NC 28542							
NO	TARGET PEST		OPERATION					PESTICIDE						TIME														
	NAME (a)	NAME (b)	TOTAL UNITS TREATED (c)	UNIT (d)	SITE (e)	NAME (f)	FORM (g)	APPLICATION		FINAL CONC. (j)	RATE (PER AREA UNIT)		SUPPLY SOURCE ENTER S, N, G, C (m)	HOURS (n)														
								AMOUNT (h)	UNIT (i)		LBS. (k)	% (l)																
13-15		17-19		20-24		25-27		28-30		31-33		34-36		37-41		42-43		44-49		50-55		56-58		68		69-71		
1.	LEA (TENTCATERPILLARS)	ENGDINSSUR			WOO																							1
2.	MICE	ENGDINSSUR			OFF																							1
3.	MICE	ENGDINSSUR			EXC																							1
4.	MICE	INTRAP (GLUE)	2	MSF	RCH																							1
5.	MICE	INTRAP (GLUE)	1	MSF	EXC																							1
6.	MICE	INTRAP (GLUE)	1	MSF	OFF																							1
7.	MICE	INTRAP (GLUE)	1	MSF	WHS																							1
8.	MICE	INTRAP		MSF	FHB																							1
9.	LEA (TENTCATERPILLARS)	MISTING	3	AC	WOO	DURSBAN	EML	100	ZGI	.01																		2
10.	LEA (ARMYWORM)	SPPDEQ	2	AC	GFG	CARBARYL	SUS	8	ZGL	.12																		3
11.	MICE	INBAIT	10	MSF	WHS	TALON	BTS	2	PDW	.005																		1
12.	MICE	INBAIT	4	MSF	OFF	TALON	BTS	1	PDW	.005																		1
13.	MICE	INBAIT	10	MSF	EXC	TALON	BTS	2	PDW	.005																		1
14.	LEA (BAGWORM)	SPPDEQ	11	AC	OPG	DURSBAN	EML	150	ZGL	.01																		9
15.	LACEBUGS	SPPDEQ	30	EA	TRE	MALATHION	EML	150	ZGL	1																		8
16.	CRICKETS	SPPDEQ	1	AC	OPG	DURSBAN	EML	25	ZGL	.01																		1
17.	FIREANTS	EXBAIT	36	AC	OPG	AMDRO	BTS	44	PDW	.88																		18
18.	BATS	OMCONTROL	3	EA	OFF																							4
19.	RATS	INBAIT	2	MSF	RCH	TALON	BTS	1	PDW	.005																		1

NO	TARGET PEST	OPERATION				PESTICIDE							TIME	
	NAME (a)	NAME (b)	TOTAL UNITS TREATED (c)	UNIT (d)	SITE (e)	NAME (f)	FORM (g)	APPLICATION		FINAL CONC. % (j)	RATE (PER AREA UNIT)		SUPPLY SOURCE ENTER S, N, G, C (m)	HOURS (n)
								AMOUNT (h)	UNIT (i)		LBS. (k)	% (l)		
	13-15	17-19	20-24	25-27	28-30	31-33	34-36	37-41	42-43	44-49	50-55	56-58	68	69-71
20.	RATS	INBAIT	4	MSF	OFF	TALON	BTS	2	PDW	.005			N	1
21.	RATS	INBAIT	2	MSF	EXC	TALON	BTS	1	PDW	.005			N	1
22.	MXGRABDLVD	SPPDEQ	38	AC	OPG	GLYPHOSATE	EML	1145	ZGL	1			N	53
23.	MXGRABDLVD	SPPDEQ	3	AC	WOO	GLYPHOSATE	EML	8	ZGL	1			N	5
24.	MXGRABDLVD	SPPDEQ	1	AC	OPG	POAST	EML	4	ZGL	1			N	4
25.	ROACHES	ENGDINSSUR			RES									13
26.	ROACHES	ENGDINSSUR			EXC									1
27.	ROACHES	ENGDINSSUR			FHB									7
28.	ROACHES	SPPDEQ	5	AC	OPG	DURSBAN	EML	80	ZGL	.01			N	4
29.	ROACHES	RESIDTR	60	MSF	EXC	DPHENOTHRIN	AER	94	FLO	2			S	6
30.	ROACHES	RESIDTR	1	MSF	RES	FICAM	DUS	1	PDW	1			N	1

## REMARKS

## INSTRUCTIONS FOR USE

- Detailed instructions of the implementing department directive shall be used in the preparation of this report.
- Military installations shall prepare this report by the 15th day after the end of each month. The report shall be prepared and signed by the DOD certified pest management supervisor, applicator or inspector and by the installation engineer.
- Three copies shall be signed and distributed as follows:
  - Copy No. 1. To the appropriate pest management professional in accordance with implementing department directives for technical review.
  - Copy No. 2. Record to the installation surgeon.
  - Copy No. 3. Record copy to the installations engineer for two year retention in accordance with Public Law 92-516.

INSTALLATION ENGINEER  
(Reviewing Officer)

TYPED NAME

M. G. LILLEY  
BASE MAINTENANCE OFFICER

SIGNATURE

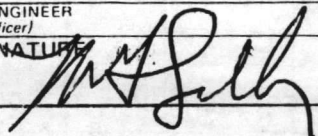

DATE (yyymmdd)

12/1/51

INSTALLATION CERTIFIED PEST MANAGEMENT SUPERVISOR,  
APPLICATOR, OR INSPECTOR

TYPED NAME

MAJOR H. GRAY  
PEST CONTROL FOREMAN

SIGNATURE

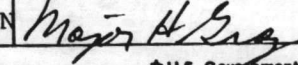

DATE (yyymmdd)

871125

PEST MANAGEMENT REPORT											CD. CODE UIC		REPORT CONTROL SYMBOL											
											10	25	3M	46	57	60	70	81	98	107	110	128	DD-M(A&AR) 1000	
NAME OF MAJOR OR REVIEWING COMMAND					ADDRESS					NAME OF REPORTING INSTALLATION					ADDRESS									
COMMANDER, ATLANTIC DIV. (10-A)					NAVAL FACILITIES ENGINEERING CMD					NORFOLK, VA 23511					MARINE CORPS BASE					CAMP LEJEUNE, NC 28542				
NO	TARGET PEST		OPERATION					PESTICIDE							TIME									
	NAME (a)	NAME (b)	TOTAL UNITS TREATED (c)	UNIT (d)	SITE (e)	NAME (f)	FORM (g)	APPLICATION		FINAL CONC. (j)	RATE (PER AREA UNIT)		SUPPLY SOURCE ENTER S, N, G, C (m)	HOURS (n)										
								AMOUNT (h)	UNIT (i)		LBS. (k)	% (l)												
	13-15	17-19	20-24	25-27	28-30	31-33	34-36	37-41	42-43	44-49	50-55	56-58	68	69-71										
1.	ROACHES	RESIDTR	5	MSF	IND	D-PHENOTHRIN	AER	11	FLO	2			S	1										
2.	ROACHES	RESIDTR	28	MSF	OFF	D-PHENOTHRIN	AER	77	FLO	2			S	3										
3.	ROACHES	RESIDTR	101	MSF	FHB	D-PHENOTHRIN	AER	174	FLO	2			S	9										
4.	ROACHES	RESIDTR	136	MSF	RES	D-PHENOTHRIN	AER	425	FLO	2			S	30										
5.	ROACHES	RESIDTR	62	MSF	UTL	D-PHENOTHRIN	AER	96	FLO	2			S	4										
6.	ROACHES	RESIDTR	2	MSF	BRQ	D-PHENOTHRIN	AER	24	FLO	2			S	2										
7.	ROACHES	RESIDTR	21	MSF	WHS	D-PHENOTHRIN	AER	76	FLO	2			S	5										
8.	ROACHES	RESIDTR	159	MSF	RCH	D-PHENOTHRIN	AER	196	FLO	2			S	11										
9.	ROACHES	RESIDTR	75	MSF	RES	D-PHENOTHRIN	AER	228	FLO	2			S	10										
10.	MXGRABDLVD	SPPDEQ	2	AC	OPG	ARSENICORG	EML	100	ZGL	1			N	3										
11.	TURF (PYTHUMLIGHT)	SPPDEQ	1	AC	GFG	TERSAN SP	SUS	6	ZGL	1			N	5										
12.	OTH (MAGGOTS)	ENGDINSSUR			RES									1										
13.	OTH (MAGGOTS)	SPPDEQ	1	AC	OPG	DURSBAN	EML	15	ZGL	.5			N	1										
14.	OTH (MAGGOTS)	RESIDTR	1	MSF	RES	DIAZINON	EML	1	ZGL	1			N	1										
15.	ROACHES	RESIDTR	13	MSF	RES	DURSBAN	EML	4	ZGL	.25			C	8										
16.	ROACHES	RESIDTR	52	MSF	RES	DURSBAN	EML	14	ZGL	.5			C	20										
17.	ROACHES	RESIDTR	27	MSF	RES	DURSBAN	EML	6	ZGL	1			C	8										
18.	ROACHES	RESIDTR	23	MSF	RES	DURSBAN-DDVP	EML	6	ZGL	1			C	7										
19.	ROACHES	RESIDTR	25	MSF	RES	PYRETHRUM	AER	4	FLO		3	.25	C	4										

NO.	TARGET PEST		OPERATION			PESTICIDE							TIME	
	NAME (a)	NAME (b)	TOTAL UNITS TREATED (c)	UNIT (d)	SITE (e)	NAME (f)	FORM (g)	APPLICATION		FINAL CONC. % (j)	RATE (PER AREA UNIT)		SUPPLY SOURCE ENTER S. N, G, C (m)	HOURS (n)
								AMOUNT (h)	UNIT (i)		LBS (k)	% (l)		
	13-15	17-19	20-24	25-27	28-30	31-33	34-36	37-41	42-43	44-49	50-55	56-58	68	69-71
20.	GRASSYWEED	SPPDEQ	2	AC	OPG	DIQUAT	EML	100	ZGL	1			N	4
21.	GRASSYWEED	SPPDEQ	2	AC	TRE	POAST	EML	50	ZGL	1			N	3
22.	MOSQUITOES	MISTING	80	AC	WOO	MALATHION	EML	400	ZGL	1			S	11
23.	MXGRABDLVD	SPHAND	2	AC	OPG	GLYPHOSATE	EML	6	ZGL	1			N	4
24.	MXGRABDLVD	SPPDEQ	32	AC	OPG	ACTAMINE	EML	1000	ZGL	1			N	22
25.	ROACHES	RESIDTR	8	MSF	BRQ	PYRETHRUM	DUS	2	PDW	.9			N	1
26.	ROACHES	RESIDTR	4	MSF	EXC	DIAZINON	EML	2	ZGL	1			S	3
27.	ROACHES	RESIDTR	4	MSF	BRQ	DIAZINON	EML	2	ZGL	1			S	3
28.	ROACHES	RESIDTR	2	MSF	HOL	DIAZINON	EML	1	ZGL	1			S	1
29.	ROACHES	RESIDTR	2	MSF	UTL	DIAZINON	EML	1	ZGL	1			S	1
30.	ROACHES	RESIDTR	5	MSF	IND	DIAZINON	EML	2	ZGL	1			S	3

## REMARKS

## INSTRUCTIONS FOR USE

- Detailed instructions of the implementing department directive shall be used in the preparation of this report.
- Military installations shall prepare this report by the 15th day after the end of each month. The report shall be prepared and signed by the DOD certified pest management supervisor, applicator or inspector and by the installation engineer.
- Three copies shall be signed and distributed as follows:
  - Copy No. 1. To the appropriate pest management professional in accordance with implementing department directives for technical review.
  - Copy No. 2. Record to the installation surgeon.
  - Copy No. 3. Record copy to the installations engineer for two year retention in accordance with Public Law 92-516.

INSTALLATION ENGINEER  
(Reviewing Officer)

TYPED NAME

M. G. LILLEY COL  
BASE MAINTENANCE OFFICER

SIGNATURE

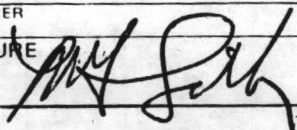

DATE (yyymmdd)

12/1/57

INSTALLATION CERTIFIED PEST MANAGEMENT SUPERVISOR,  
APPLICATOR, OR INSPECTOR

TYPED NAME

MAJOR H. GRAY  
PEST CONTROL FOREMAN

SIGNATURE

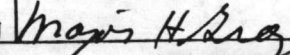

DATE (yyymmdd)

12/1/57



PEST MANAGEMENT REPORT

C.D. CODE 10 25 UIC 3M 46 57 60 70 81 98 107 110 128 REPORT CONTROL SYMBOL DD-M(A&AR) 1000

NAME OF MAJOR OR REVIEWING COMMAND ADDRESS NAME OF REPORTING INSTALLATION ADDRESS  
 COMMANDER, ATLANTIC DIV. (10-A) NAVAL FACILITIES ENGINEERING CMD NORFOLK, VA 23511 MARINE CORPS BASE CAMP LEJEUNE, NC 28542

NO	TARGET PEST		OPERATION			PESTICIDE							TIME HOURS (n)															
	NAME (a)	NAME (b)	TOTAL UNITS TREATED (c)	UNIT (d)	SITE (e)	NAME (f)	FORM (g)	APPLICATION		FINAL CONC. % (j)	RATE (PER AREA UNIT)			SUPPLY SOURCE ENTER S, N, G, C (m)														
								AMOUNT (h)	UNIT (i)		LBS. (k)	% (l)																
13-15		17-19			20-24		25-27		28-30		31-33		34-36		37-41		42-43		44-49		50-55		56-58		68		69-71	
1.	ROACHES	RESIDTR	20	MSF	OFF	DIAZINON	EML	6	ZGL	1				S	10													
2.	ROACHES	RESIDTR	14	MSF	RCH	DIAZINON	EML	6	ZGL	1				S	9													
3.	ROACHES	RESIDTR	153	MSF	RES	DIAZINON	EML	53	ZGL	1				S	43													
4.	ROACHES	RESIDTR	2	MSF	UTL	DIAZINON	EML	1	ZGL	1				S	1													
5.	ROACHES	RESIDTR	19	MSF	WHS	DIAZINON	EML	8	ZGL	1				S	9													
6.	ROACHES	RESIDTR	9	MSF	WHS	DURSBAN	SLN	6	ZGL	2				N	9													
7.	ROACHES	RESIDTR	49	MSF	WHS	DURSBAN	EML	5	ZGL	.5				N	5													
8.	ROACHES	RESIDTR	37	MSF	RES	DURSBAN	EML	9	ZGL	.5				N	14													
9.	ROACHES	RESIDTR	105	MSF	RCH	DURSEAN	EML	18	ZGL	.5				N	26													
10.	ROACHES	RESIDTR	22	MSF	BRQ	DURSBAN	EML	7	ZGL	.5				N	8													
11.	ROACHES	RESIDTR	12	MSF	OFF	DURSBAN	EML	1	ZGL	.5				N	1													
12.	ROACHES	RESIDTR	2	MSF	FHB	DURSBAN	EML	1	ZGL	.5				N	1													
13.	GRASSYWEED	SPPDEQ	5	AC	GFG	ARSENICORG	EML	224	ZGL	1				N	3													
14.	GRASSYWEED	SPHAND	1	AC	OPG	POAST	EML	4	ZGL	1				N	4													
15.	ROACHES	INBAIT	158	MSF	EXC	OSY (COMBAT)	BTS	2	PDW	1.65				S	12													
16.	ROACHES	RESIDTR	4	MSF	RCH	BORIC ACID	AER	20	FLO	20				N	1													
17.	ROACHES	INBAIT	61	MSF	WHS	OSY (COMBAT)	BTS	1	PDW	1.65				S	2													
18.	ROACHES	INBAIT	251	MSF	RCH	OSY (COMBAT)	BTS	5	PDW	1.65				S	28													
19.	ROACHES	INBAIT	6	MSF	OFF	OSY (COMBAT)	BTS	1	PDW	1.65				S	6													

NO	TARGET PEST		OPERATION			PESTICIDE							TIME	
	NAME (a)	NAME (b)	TOTAL UNITS TREATED (c)	UNIT (d)	SITE (e)	NAME (f)	FORM (g)	APPLICATION		FINAL CONC. (j)	RATE (PER AREA UNIT)		SUPPLY SOURCE ENTER S, N, G, C (m)	HOURS (n)
								AMOUNT (h)	UNIT (i)		LBS. (k)	% (l)		
	13-15	17-19	20-24	25-27	28-30	31-33	34-36	37-41	42-43	44-49	50-55	56-58	68	69-71
20.	ROACHES	INBAIT	275	MSF	FHB	OSY (COMBAT)	BTS	7	PDW	1.65			S	36
21.	ROACHES	INBAIT (GLUE)	1	MSF	OFF									1
22.	ROACHES	INBAIT (GLUE)	1	MSF	WHS									1
23.	GRASSYWEED	DGHAND	1	AC	OPG	DEVIRNOL	GRN	1	PDW	5			N	1
24.	GRASSYWEED	DGHAND	1	AC	OPG	GLYPHOSATE	EML	2	ZGL	1			N	3
25.	FLEAS	RESIDTR	13	MSF	OFF	DURSBAN	EML	3	ZGL	1			N	2
26.	FLEAS	RESIDTR	10	MSF	RCH	DURSBAN	EML	3	ZGL	.5			N	2
27.	BLDLVDWEED	SPPDEQ	165	AC	OPG	2 4 D	EML	3300	ZGL	1			N	52
28.	BLDLVDWEED	ENGDINSSUR			OPG									4
29.	CRABGRASS	SPPDEQ	5	AC	GFG	SENCOR	SUS	2	ZGL	1			N	3
30.	SAP (APHIDS)	SPPDEQ	6	AC	OPG	DIAZINON	EML	50	ZGL	1			S	2

## REMARKS

## INSTRUCTIONS FOR USE

1. Detailed instructions of the implementing department directive shall be used in the preparation of this report.
2. Military installations shall prepare this report by the 15th day after the end of each month. The report shall be prepared and signed by the DOD certified pest management supervisor, applicator or inspector and by the installation engineer.
3. Three copies shall be signed and distributed as follows:
  - a. Copy No. 1. To the appropriate pest management professional in accordance with implementing department directives for technical review.
  - b. Copy No. 2. Record to the installation surgeon.
  - c. Copy No. 3. Record copy to the installations engineer for two year retention in accordance with Public Law 92-516.

INSTALLATION ENGINEER  
(Reviewing Officer)

TYPED NAME

M. G. LILLEY, COL  
BASE MAINTENANCE OFFICER

SIGNATURE

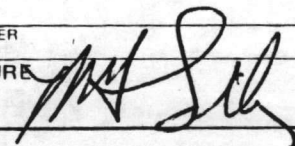

DATE (yy/mm/dd)

12/1/87

INSTALLATION CERTIFIED PEST MANAGEMENT SUPERVISOR,  
APPLICATOR, OR INSPECTOR

TYPED NAME

MAJOR H. GRAY  
PEST CONTROL FOREMAN

SIGNATURE

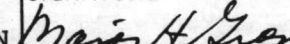

DATE (yy/mm/dd)

07/1/25

PEST MANAGEMENT REPORT

C.D. CODE UIC 0 2 5 3 M 4 6 5 7 6 0 7 0 8 1 9 8 10 11 0 12 8  
 REPORT CONTROL SYMBOL DD-M(A&AR) 1090

NAME OF MAJOR OR REVIEWING COMMAND ADDRESS NAME OF REPORTING INSTALLATION ADDRESS  
 COMMANDER, ATLANTIC DIV. (10-A) NORFOLK, VA 23511 MARINE CORPS BASE CAMP LEJEUNE, NC 28542  
 NAVAL FACILITIES ENGINEERING CMD

NO	TARGET PEST NAME (a)	OPERATION			PESTICIDE						TIME HOURS (n)			
		NAME (b)	TOTAL UNITS TREATED (c)	UNIT (d)	SITE (e)	NAME (f)	FORM (g)	APPLICATION		FINAL CONC. % (j)		RATE (PER AREA UNIT)		SUPPLY SOURCE ENTER S, N, G, C (m)
								AMOUNT (h)	UNIT (i)			LBS. (k)	% (l)	
	13-15	17-19	20-24	25-27	28-30	31-33	34-36	37-41	42-43	44-49	50-55	56-58	60	69-71
1.	SAP (APHIDS)	SPPDEQ	2	AC	OPG	MALATHION	EML	50	ZGL	1			N	4
2.	SNAKE	ENGDISSUR			OPG									1
3.	SNAKE	ENGDISSUR			RES									1
4.	TURF (DOLLARSPOT)	SPPDEQ	6	AC	GFG	DACONIL	SUS	38	ZGL	1			N	12
5.	GRASSYWEED	SPPDEQ	30	AC	OPG	GLYPHOSATE	EML	100	ZGL	1			N	8
6.	WOB	SPPDEQ	2	AC	OPG	DURSBAN	EML	65	ZGL	.01			N	4
7.	WOB	SPPDEQ	2	AC	OPB	MALATHION	EML	50	ZGL	1			S	2
8.		MAINTENANCE												132
9.		PROGRAMMING												206
10.		NONPROGRAM												422
11.														
12.														
13.														
14.														
15.														
16.														
17.														
18.														
19.														

NO.	TARGET PEST		OPERATION			PESTICIDE						TIME		
	NAME (a)	NAME (b)	TOTAL UNITS TREATED (c)	UNIT (d)	SITE (e)	NAME (f)	FORM (g)	APPLICATION		FINAL CONC. % (j)	RATE (PER AREA UNIT)		SUPPLY SOURCE	HOURS (n)
								AMOUNT (h)	UNIT (i)		LBS. (k)	% (l)	ENTER S. N, G, C (m)	
	13-15	17-19	20-24	25-27	28-30	31-33	34-36	37-41	42-43	44-49	50-55	56-58	68	69-71
20.														
21.														
22.														
23.														
24.														
25.														
26.														
27.														
28.														
29.														
30.														

REMARKS

- INSTRUCTIONS FOR USE
- Detailed instructions of the implementing department directive shall be used in the preparation of this report.
  - Military installations shall prepare this report by the 15th day after the end of each month. The report shall be prepared and signed by the DOD certified pest management supervisor, applicator or inspector and by the installation engineer.
  - Three copies shall be signed and distributed as follows:
    - Copy No. 1. To the appropriate pest management professional in accordance with implementing department directives for technical review.
    - Copy No. 2. Record to the installation surgeon.
    - Copy No. 3. Record copy to the installations engineer for two year retention in accordance with Public Law 92-516.

INSTALLATION ENGINEER  
(Reviewing Officer)

TYPED NAME M. G. LILLEY, COL  
BASE MAINTENANCE OFFICER

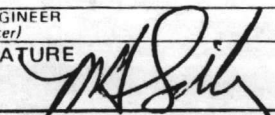
SIGNATURE 

DATE (yyymmdd) 12/1/81

INSTALLATION CERTIFIED PEST MANAGEMENT SUPERVISOR,  
APPLICATOR, OR INSPECTOR

TYPED NAME MAJOR H. GRAY  
PEST CONTROL FOREMAN

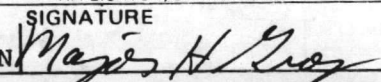
SIGNATURE 

DATE (yyymmdd) 8/21/25

PEST MANAGEMENT REPORT

CD CODE UIC 1025 3M 46 57 60 70 81 88 107 110 129 REPORT CONTROL SYMBOL DD-M(A&R) 1080

NAME OF MAJOR OR REVIEWING COMMAND ADDRESS NAME OF REPORTING INSTALLATION ADDRESS  
 COMMANDER ATLANTIC DIV (10-A) NORFOLK, VA 23511 MARINE CORPS BASE CAMP LEJEUNE, NC 28542  
 NAVAL FACILITIES ENGINEERING CMD

NO	TARGET PEST NAME (a)	OPERATION			PESTICIDE							TIME HOURS (n)															
		NAME (b)	TOTAL UNITS TREATED (c)	UNIT (d)	SITE (e)	NAME (f)	FORM (g)	APPLICATION		FINAL CONC. % (j)	RATE (PER AREA UNIT)		SUPPLY SOURCE ENTER S, N, G, C (m)														
								AMOUNT (h)	UNIT (i)		LBS. (k)			% (l)													
13-15		17-19		20-24		25-27		28-30		31-33		34-36		37-41		42-43		44-49		50-55		56-58		68		69-71	
1.	MOSQUITOES	FOGGING	3105	AC	OPG	MALATHION	SLN	86	ZGL	95													S	79			
2.	MOSQUITOES	FOGGING	280	AC	WOO	MALATHION	SLN	7	ZGL	95													S	5			
3.	MOSQUITOES	ENGDINSSUR				IMP																			35		
4.	MOSQUITOES	MISTING	220	AC	WOO	MALATHION	EML	1000	ZGL	1													N	34			
5.	MOSQUITOES	MISTING	250	AC	OPG	MALATHION	EML	550	ZGL	1													N	15			
6.	TICKS	ENGDINSSUR				WOO																			11		
7.	TICKS	MISTING	2	AC	OPG	MALATHION	EML	50	ZGL	1													S	4			
8.	WOB	SPCTR	3	MCF	BRQ	PY RETHRUM	AER	18	FLO	.05													N	1			
9.	WOB	SPCTR	4	MCF	OFF	PY RETHRUM	AER	10	FLO	.05													N	1			
10.	WOB	SPCTR	2	MSF	OPG	PY RETHRUM	AER	12	FLO	.05													N	1			
11.	WOB	EXRESIDTR	9	MSF	RES	PY RETHRUM	AER	31	FLO	.05													N	3			
12.	WOB	SPCTR	10	MCF	UTL	PY RETHRUM	AER	90	FLO	.05													N	6			
13.	WOB	SPCTR	1	MCF	WHS	PY RETHRUM	AER	4	FLO	.05													N	1			
14.	WOB	RESIDTR	24	MSF	RCH	PY RETHRUM	AER	208	FLO	.05													N	7			
15.	WOB	SPPDEQ	1	AC	OPG	DURSBAN	EML	25	ZGL	1													N	3			
16.	WOB	ENGDINSSUR				WOO																			3		
17.	WOB	ENGDINSSUR				RES																			2		
18.	MOSQUITOES	MEDDINSSUR																							126		
19.	MOSQUITOES	DGHAND	1	AC	WOO	BACTIMOS	BRQ	2	PDW	10													N	5			

NO.	TARGET PEST	OPERATION			PESTICIDE							TIME		
	NAME (a)	NAME (b)	TOTAL UNITS TREATED (c)	UNIT (d)	SITE (e)	NAME (f)	FORM (g)	APPLICATION		FINAL CONC. (j)	RATE (PER AREA UNIT)		SUPPLY SOURCE ENTER S, N, G, C (m)	HOURS (n)
								AMOUNT (h)	UNIT (i)		LBS (k)	% (l)		
	13-15	17-19	20-24	25-27	28-30	31-33	34-36	37-41	42-43	44-49	50-55	56-58	60	69-71
20.	SUBTERMS	ENGDINSSUR			RCH									5
21.	MOSQUITOES	SPHAND	24	AC	IMP	FLITMO	SLN	79	ZGL	98			N	82
22.	MOSQUITOES	SPHAND	41	AC	IMP	LARVATROL	SLN	43	ZGL	90			N	131
23.	MOSQUITOES	SPCTR	10	MCF	RCH	D-PHENOTHRIN	AER	30	FLO	2			S	1
24.	SPIDERMITES	SPPDEQ	6	MSF	OPG	DIMETHOATE	EML	65	ZGL	1			N	8
25.	FILTHFLIES	ENGDINSSUR			LDF									3
26.	FILTHFLIES	SPCTR	10	MSF	FHB	PYRETHRUM	SLN	1	ZGL	3			N	1
27.	FILTHFLIES	STEAMCLEAN	79	EA	TGC									120
28.	FILTHFLIES	RESIDTR	7	AC	LDF	MALATHION	EML	100	ZGL	1			S	6
29.	FILTHFLIES	RESIDTR	819	MSF	KEN	MALATHION	EML	300	ZGL	1			S	24
30.	FILTHFLIES	EXRESIDTR	37	EA	TGC	DIMETHOATE	EML	85	ZGL	1			S	9

## REMARKS

## INSTRUCTIONS FOR USE

- Detailed instructions of the implementing department directive shall be used in the preparation of this report.
- Military installations shall prepare this report by the 15th day after the end of each month. The report shall be prepared and signed by the DOD certified pest management supervisor, applicator or inspector and by the installation engineer.
- Three copies shall be signed and distributed as follows:
  - Copy No. 1. To the appropriate pest management professional in accordance with implementing department directives for technical review.
  - Copy No. 2. Record to the installation surgeon.
  - Copy No. 3. Record copy to the installations engineer for two year retention in accordance with Public Law 92-516.

INSTALLATION ENGINEER  
(Reviewing Officer)

SIGNATURE

TYPED NAME  
M. G. LILLEY  
BASE MAINTENANCE OFFICER

DATE (yy/mm/dd)

12/21/57

INSTALLATION CERTIFIED PEST MANAGEMENT SUPERVISOR,  
APPLICATOR, OR INSPECTOR

SIGNATURE

TYPED NAME  
MAJOR H. GRAY  
PEST CONTROL FOREMAN

DATE (yy/mm/dd)

87/2/10

PEST MANAGEMENT REPORT

C.D. CODE UIC 0 2 5 3 M 4 6 5 7 6 0 7 0 8 1 9 8 10 7 11 0 12 9  
 REPORT CONTROL SYMBOL DD-M(A&R) 1080

NAME OF MAJOR OR REVIEWING COMMAND ADDRESS NAME OF REPORTING INSTALLATION ADDRESS  
 COMMANDER ATLANTIC DIV. (10-A) NORFOLK, VA 23511 MARINE CORPS BASE CAMP LEJEUNE, NC 28542  
 NAVAL FACILITIES ENGINEERING CMD

NO	TARGET PEST NAME (a) 13-15	OPERATION				PESTICIDE							TIME HOURS (n) 69-71	
		NAME (b) 17-19	TOTAL UNITS TREATED (c) 20-24	UNIT (d) 25-27	SITE (e) 28-30	NAME (f) 31-33	FORM (g) 34-36	APPLICATION		FINAL CONC. % (j) 44-49	RATE (PER AREA UNIT)			SUPPLY SOURCE ENTER S, N, G, C (m) 68
								AMOUNT (h) 37-41	UNIT (i) 42-43		LBS. (k) 50-55	% (l) 56-58		
1.	FLEAS	RESIDTR	2	MSF	RES	DIAZINON	EML	1	ZGL	1			S	1
2.	FLEAS	RESIDTR	3	MSF	OFF	DURSBAN	EML	2	ZGL	.5			N	2
3.	FLEAS	RESIDTR	2	MSF	RCH	DURSBAN	EML	1	ZGL	1			N	7
4.	FLEAS	SPPDEQ	1	AC	OPG	DURSBAN	EML	25	ZGL	.01			N	1
5.	FLEAS	SPCTR	1	MCF	RES	PYRETHRUM	AER	10	FLO	.04			S	1
6.	FLEAS	RESIDTR	1	MSF	RCH	FICAM	SUS	1	ZGL	.25			N	1
7.	FLEAS	RESIDTR	18	MSF	OFF	FICAM	SUS	2	ZGL	.5			N	3
8.	FLEAS	RESIDTR	6	MSF	RES	DURSBAN	EML	3	ZGL	.5			N	5
9.	FLEAS	RESIDTR	1	MSF	RES	DURSBAN	EML	1	ZGL	.5			C	1
10.	FLEAS	ENGDINSSUR			BRQ									2
11.	FIREANTS	ENGDINSSUR			UTL									2
12.	FIREANTS	SPPDEQ	560	AC	OPG	DURSBAN	EML	7719	ZGL	.01			N	408
13.	FIREANTS	EXBAIT	34	AC	OPG	OSY (AMDRO)	BTS	20	PDW	.88			N	17
14.	ANTS	SPPDEQ	4	AC	OPG	DURSBAN	EML	20	ZGL	.01			N	1
15.	ANTS	RESIDTR	4	MSF	RCH	DIAZINON	EML	1	ZGL	1			S	2
16.	ANTS	RESIDTR	3	MSF	OFF	DIAZINON	EML	2	ZGL	1			S	2
17.	ANTS	RESIDTR	22	MSF	UTL	DURSBAN	EML	3	ZGL	.5			N	2
18.	ANTS	RESIDTR	24	MSF	BRQ	DURSBAN	EML	6	ZGL	.5			N	5
19.	ANTS	INBAIT	1	MSF	IND	OSY (AMDRO)	BTS	1	PDW	.88			N	1

NO.	TARGET PEST NAME (a) 13-15	OPERATION			PESTICIDE							TIME HOURS (n) 69-71		
		NAME (b) 17-19	TOTAL UNITS TREATED (c) 20-24	UNIT (d) 25-27	SITE (e) 28-30	NAME (f) 31-33	FORM (g) 34-36	APPLICATION		FINAL CONC. % (j) 44-49	RATE (PER AREA UNIT)		SUPPLY SOURCE ENTER S, N, G, C (m) 68	
								AMOUNT (h) 37-41	UNIT (i) 42-43		LBS. (k) 50-55			% (l) 56-58
20.	LEA (ARMYWORM)	SPPDEQ	1	EA	TRE	DURSBAN	EML	15	ZGL	.01			N	2
21.	ROO (ARMYWORM)	SPPDEQ	11	AC	GFG	DIAZINON	EML	700	ZGL	.05			N	5
22.	OTH (POSSUM)	ENGDISSUR			WHS									1
23.	BIRDMITES	SPCTR	1	MCF	OFF	D-PHENOTHRIN	AER	4	FLO	2			S	1
24.	BOOKLICE	SPCTR	5	MCF	OFF	PYRETHRUM	SLN	1	ZGL	3			N	1
25.	FOODPEST	ENGDISSUR			WHS									4
26.	FOODPEST	SPCTR	1235	MCF	WHS	DCHLORVOS	SLN	59	ZGL	5.62			N	11
27.	OTP (CAT)	ENGDISSUR			OPG									1
28.	EARWIGS	SPPDEQ	1	AC	OPG	DURSBAN	EML	20	ZGL	.01			N	1
29.	CARCASS	ENGDISSUR			RES									2
30.	CARCASS	SPCTR	1	MCF	RES	ULD 20	EML	1	ZGL	NA			N	1

## REMARKS

## INSTRUCTIONS FOR USE

- Detailed instructions of the implementing department directive shall be used in the preparation of this report.
- Military installations shall prepare this report by the 15th day after the end of each month. The report shall be prepared and signed by the DOD certified pest management supervisor, applicator or inspector and by the installation engineer.
- Three copies shall be signed and distributed as follows:
  - Copy No. 1. To the appropriate pest management professional in accordance with implementing department directives for technical review.
  - Copy No. 2. Record to the installation surgeon.
  - Copy No. 3. Record copy to the installations engineer for two year retention in accordance with Public Law 92-516.

INSTALLATION ENGINEER  
(Reviewing Officer)TYPED NAME  
M. G. LITTLE  
BASE MAINTENANCE OFFICER

SIGNATURE

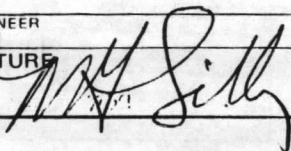

DATE (yyymmdd)

12/1/87

INSTALLATION CERTIFIED PEST MANAGEMENT SUPERVISOR,  
APPLICATOR, OR INSPECTORTYPED NAME  
MAJOR H. GRAY  
PEST CONTROL FOREMAN

SIGNATURE

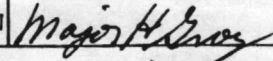

DATE (yyymmdd)

871210



PEST MANAGEMENT REPORT

C.D. CODE UIC 10 2 5 3 M 4 6 5 7 6 0 7 0 8 1 9 8 10 7 11 0 12 9  
 REPORT CONTROL SYMBOL DD-M(ABAR) 1000

NAME OF MAJOR OR REVIEWING COMMAND ADDRESS NAME OF REPORTING INSTALLATION ADDRESS  
 COMMANDER, ATLANTIC DIV. (10-A) NORFOLK, VA 23511 MARINE CORPS BASE CAMP LEJEUNE, NC 28542  
 NAVAL FACILITIES ENGINEERING CMD

NO	TARGET PEST NAME (a) 13-15	OPERATION					PESTICIDE							TIME HOURS (n) 69-71		
		NAME (b) 17-19	TOTAL UNITS TREATED (c) 20-24	UNIT (d) 25-27	SITE (e) 28-30	NAME (f) 31-33	FORM (g) 34-36	APPLICATION		FINAL CONC. % (j) 44-49	RATE (PER AREA UNIT)		SUPPLY SOURCE ENTER S, N, G, C (m) 68			
								AMOUNT (h) 37-41	UNIT (i) 42-43		LBS. (k) 50-55	% (l) 56-58				
1.	MICE	ENGDINSSUR			WHS											1
2.	MICE	ENGDINSSUR			OFF											1
3.	MICE	ENGDINSSUR			RES											1
4.	MICE	INTRAP (GLUE)	2	MSF	FHB									N		1
5.	MICE	INTRAP (GLUE)	11	MSF	EXC									N		2
6.	MICE	INTRAP (GLUE)	2	MSF	OFF									N		1
7.	MICE	INTRAP	1	MSF	FHB									S		1
8.	MICE	INTRAP	3	MSF	BRQ									S		1
9.	MICE	EXTRAP	12	MSF	WHS	ANTICOAG	BTS	1	ZGL	.005				N		2
10.	MICE	BAIT	4	MSF	OFF	TALON	BTS	1	PDW	.005				N		1
11.	MICE	INBAIT	4	MSF	WHS	TALON	BTS	1	PDW	.005				N		1
12.	MICE	INBAIT	14	MSF	OFF	TALON	BTS	5	PDW	.005				N		3
13.	MICE	INBAIT	57	MSF	RCH	TALON	BTS	3	PDW	.005				N		4
14.	MICE	INBAIT	10	MSF	EXC	TALON	BTS	2	PDW	.005				N		2
15.	MICE	INTRAP	1	MCF	RES									S		1
16.	SAP LACE	SPPDEQ	7	AC	OPG	MALATHION	EML	140	ZGL	1				S		15
17.	SLVRSOCID	SPCTR	1	MCF	OFF	PYRETHRUM	SLN	1	ZGL	3				N		1
18.	SLVRSOCID	DGHAND	1	MSF	WHS	MOTHBALLS	DDP	7	PDW	NA				N		1
19.	MXGRABDLVD	ENGDINSSUR														1

NO.	TARGET PEST NAME (a)	OPERATION				PESTICIDE							TIME HOURS (n)	
		NAME (b)	TOTAL UNITS TREATED (c)	UNIT (d)	SITE (e)	NAME (f)	FORM (g)	APPLICATION		FINAL CONC. % (j)	RATE (PER AREA UNIT)			SUPPLY SOURCE ENTER S. N, G, C (m)
								AMOUNT (h)	UNIT (i)		LBS. (k)	% (l)		
	13-15	17-19	20-24	25-27	28-30	31-33	34-36	37-41	42-43	44-49	50-55	56-58	68	69-71
20.	MXGRABDLVD	SPPDEQ	1	AC	OPG	DIQUAT	EML	100	ZGL	1			N	3
21.	RATS	INBAIT	2	MSF	BRQ	TALON	BTS	1	PDW	.005			N	2
22.	GRASSYWEED	SPPDEQ	4	EA	TRE	POAST	EML	2	ZGL	1			N	2
23.	MXGRABDLVD	SPPDEQ	17	AC	OPG	GLYPHOSATE	EML	1150	ZGL	1			N	44
24.	MXGRABDLVD	SPHAND	2	AC	OPG	GLYPHOSATE	EML	8	ZGL	1			N	4
25.	ROACHES	ENGDINSSUR												5
26.	ROACHES	ENGDINSSUR												6
27.	ROACHES	ENGDINSSUR												1
28.	ROACHES	RESIDTR	4	MSF	BRQ	D-PHENOTHRIN	AER	10	FLO	2			S	1
29.	ROACHES	RESIDTR	20	MSF	EXC	D-PHENOTHRIN	AER	44	FLO	2			S	3
30.	ROACHES	RESIDTR	93	MSF	FHB	D-PHENOTHRIN	AER	173	FLO	2			S	13

## REMARKS

## INSTRUCTIONS FOR USE

- Detailed instructions of the implementing department directive shall be used in the preparation of this report.
- Military installations shall prepare this report by the 15th day after the end of each month. The report shall be prepared and signed by the DOD certified pest management supervisor, applicator or inspector and by the installation engineer.
- Three copies shall be signed and distributed as follows:
  - Copy No. 1. To the appropriate pest management professional in accordance with implementing department directives for technical review.
  - Copy No. 2. Record to the installation surgeon.
  - Copy No. 3. Record copy to the installations engineer for two year retention in accordance with Public Law 92-516.

INSTALLATION ENGINEER  
(Reviewing Officer)

SIGNATURE

TYPED NAME  
M. G. LILLEY  
BASE MAINTENANCE OFFICER

DATE (yyymmdd)

12/11/87

INSTALLATION CERTIFIED PEST MANAGEMENT SUPERVISOR,  
APPLICATOR, OR INSPECTOR

SIGNATURE

TYPED NAME  
MAJOR H. GRAY  
PEST CONTROL FOREMAN

DATE (yyymmdd)

871210

PEST MANAGEMENT REPORT

CD CODE UIC 01253M14657607081981070129  
 REPORT CONTROL SYMBOL DD-M(A&AR) 1080

NAME OF MAJOR OR REVIEWING COMMAND: COMMANDER, ATLANTIC DIV. (10-A) NAVAL FACILITIES ENGINEERING CMD  
 ADDRESS: NORFOLK, VA 23511  
 NAME OF REPORTING INSTALLATION: MARINE CORPS BASE  
 ADDRESS: CAMP LEJEUNE, NC 28542

NO	TARGET PEST NAME (a)	OPERATION			PESTICIDE								TIME HOURS (n)	
		NAME (b)	TOTAL UNITS TREATED (c)	UNIT (d)	SITE (e)	NAME (f)	FORM (g)	APPLICATION		FINAL CONC. % (j)	RATE (PER AREA UNIT)			SUPPLY SOURCE ENTER S, N, G, C (m)
								AMOUNT (h)	UNIT (i)		LBS. (k)	% (l)		
13-15		17-19	20-24	25-27	28-30	31-33	34-36	37-41	42-43	44-49	50-55	56-58	68	69-71
1.	ROACHES	SELF-HELP												4
2.	ROACHES	RESIDTR	11	MSF	RCH	D- PHENOTHRIN	AER	18	FLO	2			S	2
3.	ROACHES	RESIDTR	182	MSF	RES	D- PHENOTHRIN	AER	405	FLO	2			S	37
4.	ROACHES	RESIDTR	18	MSF	UTL	D- PHENOTHRIN	AER	16	FLO	2			S	1
5.	ROACHES	RESIDTR	13	MSF	WHS	D- PHENOTHRIN	AER	28	FLO	.25			S	4
6.	ROACHES	RESIDTR	12	MSF	RCH	D- PHENOTHRIN	AER	8	FLO	.25			S	1
7.	ROACHES	RESIDTR	1	MSF	RES	DRIONE	DUS	5	PDW	1			N	1
8.	ROACHES	RESIDTR	11	MSF	RES	DURSBAN	EML	4	ZGL	.25			C	6
9.	ROACHES	RESIDTR	21	MSF	BRQ	DIAZINON	EML	6	ZGL	1			S	7
10.	ROACHES	RESIDTR	1	MSF	EXC	DIAZINON	EML	1	ZGL	1			S	1
11.	ROACHES	RESIDTR	2	MSF	IND	DIAZINON	EML	1	ZGL	1			S	1
12.	ROACHES	RESIDTR	7	MSF	OFF	DIAZINON	EML	5	ZGL	1			S	5
13.	ROACHES	RESIDTR	154	MSF	RES	DIAZINON	EML	80	ZGL	1			S	42
14.	ROACHES	RESIDTR	3	MSF	UTL	DIAZINON	EML	1	ZGL	1			S	2
15.	ROACHES	RESIDTR	21	MSF	WHS	DIAZINON	EML	16	ZGL	1			S	13
16.	ROACHES	RESIDTR	54	MSF	RES	DURSBAN	EML	15	ZGL	.5			C	21
17.	ROACHES	RESIDTR	19	MSF	RES	DURSBAN	EML	4	ZGL	.5			N	8
18.	ROACHES	RESIDTR	20	MSF	RCH	DURSBAN	EML	1	ZGL	.5			N	2
19.	ROACHES	RESIDTR	12	MSF	OFF	DURSBAN	EML	3	ZGL	.5			N	5

NO.	TARGET PEST NAME (a)	OPERATION				PESTICIDE							TIME HOURS (n)	
		NAME (b)	TOTAL UNITS TREATED (c)	UNIT (d)	SITE (e)	NAME (f)	FORM (g)	APPLICATION		FINAL CONC. % (j)	RATE (PER AREA UNIT)			SUPPLY SOURCE ENTER S, N, G, C (m)
								AMOUNT (h)	UNIT (i)		LBS. (k)	% (l)		
	13-15	17-19	20-24	25-27	28-30	31-33	34-36	37-41	42-43	44-49	50-55	56-58	60	69-71
20.	ROACHES	RESIDTR	28	MSF	UTL	DURSBAN	EML	2	ZGL	.5			N	3
21.	ROACHES	INBAIT	101	MSF	EXC	OSY (COMBAT)	BTS	3	PDW	1.65			S	23
22.	ROACHES	INBAIT	228	MSF	RCH	OSY (COMBAT)	BTS	3	PDW	1.65			S	24
23.	ROACHES	INBAIT	1	MSF	OFF	OSY (COMBAT)	BTS	1	PDW	1.65			S	1
24.	ROACHES	INBAIT	154	MSF	FHB	OSY (COMBAT)	BTS	6	PDW	1.65			S	40
25.	ROACHES	INBAIT	4	MSF	BRQ	OSY (COMBAT)	BTS	1	PDW	1.65			S	1
26.	ROACHES	INBAIT	3	MSF	WHS	OSY (COMBAT)	BTS	1	PDW	1.65			S	2
27.	SAPMITES	SPPDEQ	5	AC	OPG	MALATHION	SUP	300	ZGL	1			N	15
28.		MAINTENANCE												55
29.		PROGRAMMING												230
30.		NONPROGRAM												332

## REMARKS

## INSTRUCTIONS FOR USE

1. Detailed instructions of the implementing department directive shall be used in the preparation of this report.
2. Military installations shall prepare this report by the 15th day after the end of each month. The report shall be prepared and signed by the DOD certified pest management supervisor, applicator or inspector and by the installation engineer.
3. Three copies shall be signed and distributed as follows:
  - a. Copy No. 1. To the appropriate pest management professional in accordance with implementing department directives for technical review.
  - b. Copy No. 2. Record to the installation surgeon.
  - c. Copy No. 3. Record copy to the installations engineer for two year retention in accordance with Public Law 92-516.

INSTALLATION ENGINEER  
(Reviewing Officer)TYPED NAME  
M. G. LILLEY  
BASE MAINTENANCE OFFICER

SIGNATURE

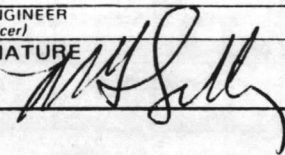

DATE (yyymmdd)

12/11/87

INSTALLATION CERTIFIED PEST MANAGEMENT SUPERVISOR,  
APPLICATOR, OR INSPECTORTYPED NAME  
MAJOR H. GRAY  
PEST CONTROL FOREMAN

SIGNATURE

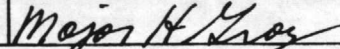

DATE (yyymmdd)

871210