

10 YEAR  
MANAGEMENT  
PLAN

1974

NATURAL RESOURCES MANAGEMENT PLAN

CAMP LEJEUNE, NORTH CAROLINA

This plan is prepared by the Marine Corps Base and the Onslow Soil Conservation District. Technical assistance was provided by the United States Department of Agriculture - Soil Conservation Service. Publication was arranged through a Cooperative Agreement between the Department of the Navy, the Marine Corps Base and the Soil Conservation Service - United States Department of Agriculture.

March 1975

MEMORANDUM FOR THE RECORD  
DATE: 10/10/54



# TABLE OF CONTENTS

PAGE

INTRODUCTION . . . . .	1
A. Location and History . . . . .	1
B. Past Management Plans . . . . .	2
C. Purpose of the Plan . . . . .	3
D. Description of Area and Resources . . . . .	3
E. Conservation Problem Areas . . . . .	7
F. Acreage Analysis . . . . .	9
G. Natural Resources and Environmental Affairs Division . . . . .	10
H. Committee for Environmental Enhancement . . . . .	10
IMPROVED GROUNDS MANAGEMENT PROGRAM . . . . .	13
A. Lawns . . . . .	13
Table 1 - Adapted Warm Season Grasses . . . . .	15
B. Trees and Shrubs . . . . .	17
Table 2 - Schedule of Plant Needs . . . . .	18
Table 3 - Plants to be Purchased and Produced for Landscape Improvement and Maintenance . . . . .	25
C. Mowed Areas Other Than Lawns . . . . .	26
D. Channel Improvement and Stream Stabilization . . . . .	27
E. Roadside Stabilization . . . . .	27
F. Air Pollution Control . . . . .	28
G. Soil and Water Pollution Control . . . . .	28
H. Special Treatment Areas . . . . .	30
I. Schedule of Special Treatment Areas by Site Numbers . . . . .	49
J. Improved Grounds and Wildlife Maps, Resource Conservation Plan . . . . .	follows p. 50
WILDLIFE MANAGEMENT PROGRAM . . . . .	51
A. Introduction . . . . .	51
B. Use of Soil Interpretations in Wildlife Resource Programs . . . . .	51
C. Table 4 - Wildlife Habitat Suitability Interpretations . . . . .	54
D. Map of Wildlife Units . . . . .	follows p. 54
E. Wildlife Resources . . . . .	55
F. Public Use of Wildlife . . . . .	55
G. Table 5 - Estimated Wildlife Resources Value . . . . .	57
H. Personnel Requirements . . . . .	57
I. Funding Procedures . . . . .	58
J. Development and Maintenance Cost . . . . .	58
K. Agricultural Practices . . . . .	59
L. Wildlife - Forestry Coordination . . . . .	61
M. Census Techniques and Harvest Surveys . . . . .	62
N. Management Plans . . . . .	62
O. Habitat Types and Associated Wildlife . . . . .	73

	PAGE
P. Inventory of Present Game Species . . . . .	79
Q. Inventory Present Nongame Species . . . . .	90
R. Fish Management . . . . .	95
S. Fishery Habitat and Associated Fish Resources . . . . .	97
T. Forest - Wide Wildlife Habitat Inventory Data Sheets . . . . .	108
U. Cooperative Plan . . . . .	136
 RECREATION AREAS MAINTENANCE PROGRAM . . . . .	 139
A. Athletic Fields . . . . .	139
B. Skeet Range . . . . .	140
C. Campsites . . . . .	140
D. Onslow Beach . . . . .	140
E. Picnic Area . . . . .	140
F. Grazed Areas . . . . .	140
G. Golf Courses . . . . .	142
H. Soils for Recreational Development . . . . .	143
Table 6 - Interpretations for Selected Recreational Uses . . . . .	145
 FORESTRY MANAGEMENT PROGRAM . . . . .	 149
A. Introduction . . . . .	149
B. Forest Description . . . . .	149
Table 7 - Volume Table By Group Species in Cubic Feet, Board Feet and Basal Area . . . . .	 150
Table 8 - Acres of Forest Types by Size Class . . . . .	150
Table 9 - Volume and Basal Area by Diameter Class of Each Species Group . . . . .	 151
C. Management Changes . . . . .	155
D. Objectives . . . . .	156
E. Management Plan . . . . .	156
F. Regulations . . . . .	159
G. Use of Soil Interpretations in Woodland Programs . . . . .	159
Table 10 - Woodland Suitability Interpretations . . . . .	161
H. Work Schedule from 1975 - 1984 . . . . .	164
I. Stand Maps . . . . .	follows p. 174
J. Forest Stand Maps, Resource Conservation Plan . . . . .	175
 APPENDIX . . . . .	 follows p. 236
A. Soil Maps . . . . .	follows p. 236
B. How the Survey Was Made . . . . .	237
C. Soil Identification Legend . . . . .	239
D. List of Conventional Symbols Used on Field Sheets . . . . .	240
E. Soil Descriptions . . . . .	241
F. Engineering Uses of Soils . . . . .	257
1. Engineering Soil Classification Systems . . . . .	258
2. Soil Properties Significant to Engineering . . . . .	258

G.	Engineering Interpretations of Soils . . . . .	260
	Table 11 - Estimated Physical and Chemical Properties of Soils . . . . .	263
	Table 12 - Intrepretations of Engineering Properties of Soils . . . . .	266
H.	Bibliography . . . . .	277
I.	Critical Area Planting (Permanent Seeding on Graded Develop- ment Areas, Etc.) Table 13 . . . . .	278
J.	Critical Area Planting (Permanent Seeding on Dams, Mine Spoils, Denuded or Gullied Areas, Etc.) Table 14 . . . . .	286
K.	Critical Area Planting (Permanent Seeding on Dikes, Ditch Banks, Etc.) . . . . .	294
L.	Critical Area Planting (Stilling Sand in Coastal Dune Areas) . . . . .	300
M.	Critical Area Planting (Short Term Seedings) . . . . .	302
N.	Critical Area Planting (Shurbs, Vines, Trees and Other Plants) . . . . .	306
	Table 15 . . . . .	308
O.	Specifications for Sand Cement Bag Rip Rap . . . . .	313
P.	Cross Section of Diversion for Tank Trails . . . . .	314
Q.	Typical Cross Section of the Dike Proposed for the 1800 Area . . . . .	314
R.	Debris (Sediment) Basin . . . . .	314
S.	Diversions with Pipe Drops . . . . .	314
T.	Example of Storm Water Detention Basin . . . . .	315
U.	Catch Basin . . . . .	315
V.	Grassed Waterway or Outlet - Table 16 . . . . .	316
W.	Diversion - Table 17 . . . . .	321
X.	Groin System . . . . .	326
Y.	Pasture and Hayland Planting- Table 18 . . . . .	328
Z.	Pasture and Hayland Management - Tables 19 & 20 . . . . .	331
AA.	Fish Pond Management . . . . .	335
BB.	Seeding Rates for Wildlife Plantings-Table 21 . . . . .	342
CC.	Wood Duck Nesting Box . . . . .	343
DD.	Conservation Application and Agreement . . . . .	344



# INTRODUCTION

A NATURAL RESOURCE AREA

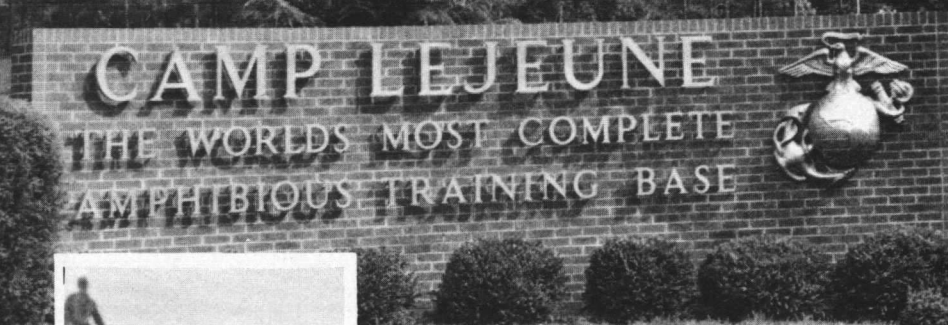



INTRODUCTION

# CAMP LEJEUNE REGION



# INTRODUCTION

## A. LOCATION AND HISTORY

1. Camp Lejeune - Marine Corps Base, Camp Lejeune is located in Onslow County on the southeastern coast of North Carolina. Bisected by New River, it has over eleven miles of frontage on the Atlantic Ocean and has a perimeter of 68 miles which embraces more than 170 square miles.

### II FOREST MANAGEMENT HISTORY

Camp Lejeune, known as "The World's Most Complete Amphibious Training Base," came into existence in the late 1930's when the Marine Corps realized that its training facilities must be expanded. This area was selected after considering areas from Maine to Florida for the purpose of establishing a Marine Corps Base. Procurement of the land began in 1940.

Prior to 1940 the land was privately owned. Tracts ranged in size from less than an acre to several thousand acres. There were about 6,000 acres of open farmland with much of the woodland having been cut over and denuded of merchantable timber. However, some stands of fine merchantable timber remained. There was little or no fire protection and the wildlife habitat was generally poor.

Construction of the new camp, named in honor of Lieutenant General JOHN A. LEJEUNE, USMC began in April 1941. When Lieutenant Colonel W. P. T. HILL assumed command as Camp Lejeune's first Commanding Officer on 1 May 1941, an old summer cottage was used for the Headquarters. During World War II, Camp Lejeune served as a training base for marines bound for overseas combat duty. Since 1946, it has served as the home base of the 2nd MARINE DIVISION and other FLEET MARINE FORCE UNITS.

During the construction period of Camp Lejeune, nine million board feet of timber were harvested from the reservation by ground sawmills operated by Navy Construction Battalions. <sup>AND THE LUMBER</sup> The lumber was used in local construction projects. In 1944 a sawmill with a daily capacity of 10,000 board feet was put into operation by Base Maintenance. <sup>WITH</sup> The lumber <sup>WAS</sup> used in routine maintenance and minor construction. The sawmill ceased operation in 1954. Timber sales by contract were initiated in 1946 and have continued until the present. <sup>TIMBER SALE</sup>

<sup>for pulpwood were initiated in 1946 and sawtimber sales were began when the</sup> <sup>BASE</sup> sawmill was closed in 1954.

With the closing of the woodlands to the public, controlled hunting and forest fire control game populations began to increase - especially deer, turkey and raccoon. From 1941 to 1946 it is estimated that the deer population more than tripled. By 1950 nearly all of the suitable deer habitat had reached its carrying potential. It is also estimated that since 1941 the turkey population has increased from a low of approximately 100 birds to a present day population of 800 to 900 birds.

2. Marine Corps Air Station, New River - The Marine Corps Air Station, New River is located on the northwest side of Camp Lejeune and south of Jacksonville. It embraces approximately 2,672 acres. Originally a part of Camp Lejeune, USMC Air Facility, Peterfield Point was surveyed and set up as a separate command in 1951. It was used as a helicopter training base and as a touch-and-go training field for jet fighters during the Korean War. The base underwent a name change in 1968 and is now the Marine Corps Air Station, New River.

3. HOLF, Oak Grove - The Helicopter Outlying Landing Field, Oak Grove, Pollocksville is located in the eastern part of Jones County, North Carolina. It embraces 976 acres and is bounded on two sides by the Trent River. The land was acquired through condemnation proceedings in 1942. The area was named the Marine Corps Outlying Landing Field, Oak Grove and was under the Cherry Point Air Station Command. Two squadrons of the Sixth Wing Aircraft were based there for training during the latter part of World War II. At the end of World War II, these squadrons were deactivated and all the base structures were destroyed except the runway complex. With the introduction of the jet fighter, the runways at the Outlying Landing Field were used for touch-and-go training until 1968.

In 1968 the Marine Corps Outlying Field, Oak Grove was placed under the command of the Marine Corps Air Station, New River. The name was changed to the Helicopter Outlying Landing Field, Oak Grove. It has been used for helicopter training since 1968.

B. PAST MANAGEMENT PLANS

Since World War II, natural resources management at Camp Lejeune has been centered on the multiple-use concept with the primary land uses being (1) military training, (2) forestry, (3) wildlife and (4) recreation. The first forest management plan for Camp Lejeune which included the lands now known as the Marine Corps Air Station, New River was developed and put into effect in 1946 and revised in 1954. Wildlife management plans were less formal. However, wildlife management practices such as planting of wildlife food plots and game harvest were carried on regularly.

In 1964 in cooperation with the US Forest Service and the US Soil Conservation Service, a complete forest inventory and soil survey were made. Using the inventory and survey data as a base, a forest management plan for a ten-year period was developed, based on the even-aged management concept. The plan provided for scheduled timber harvests, prescribed burning and reforestation.

In 1968 the first wildlife management plan was developed. The plan set forth long range management for all fish and wildlife species on the area. Planning direction considered general management practices for game as well as for all nongame wildlife.

Natural resource management at the Marine Corps Air Station, New River was carried out as a part of natural resource management at Camp Lejeune until 1951. In 1956 a cooperative agreement was signed with the Lower Neuse Soil and Water Conservation District asking for their assistance in developing a long-term plan in erosion control and grounds maintenance. The Soil Conservation Service, USDA working through the local Soil Conservation District completed the plan in June 1956. The plan included soils inventory data, soil interpretations and maintenance requirements for the base grounds. It also identified and prescribed treatment for special problem areas. The soil survey was revised in the early sixties and subsequent natural resource management plans were developed by specialists from the District Public Works Office, Fifth Naval District, Norfolk, Virginia. In July 1974 all Class I property management was placed under the Base Maintenance Department of the Marine Corps Base, Camp Lejeune.

The Helicopter Outlying Landing Field, Oak Grove was managed by the Natural Resources staff of Cherry Point until 1957. At that time the Public Works Office, Fifth Naval District Norfolk, Virginia entered into a cooperative agreement with the Lower Neuse Soil and Water Conservation District requesting assistance in developing an erosion control plan. In July 1958 the plan containing a soil survey report and recommendations for erosion control was completed. A soil and water conservation plan for agricultural outleasements was developed in 1965. The natural resources management of HOLF, Oak Grove became the responsibility of the staff of the Marine Corps Air Station, New River in 1968. Responsibility of natural resource management at this facility was transferred to the Natural Resources and Environmental Affairs Division of the Marine Corps Base, Camp Lejeune in 1974.

This natural resource management plan covers the management of natural resources at the Marine Corps Base, Camp Lejeune, the Marine Corps Air Station, New River and the Helicopter Outlying Landing Field, Oak Grove. The staff of the Natural Resources and Environmental Affairs Division at the Marine Corps Base, Camp Lejeune has the responsibility of natural resources management at all three facilities. Throughout the plan the reference to natural resources management at Camp Lejeune therefore, refers to management of natural resources at all three facilities.

#### C. PURPOSE OF THE PLAN

This Natural Resources Management Plan established a long-term program for the sound management and use of soil and water resources, forests and other beneficial vegetation, fish, wildlife and recreational resources. The plan provides for multiple-use of all lands except impact areas and demolition ranges. The plan further provides for solutions to existing problems of erosion, poor drainage, water, soil and air pollution, wildfires, forest insect and disease damage, unproductive wildlife habitat and maintaining existing vegetative cover.

#### D. DESCRIPTION OF AREA AND RESOURCES

1. Geology - Camp Lejeune is in the lower Coastal Plain of eastern North Carolina. This land originated in a marine or coastal environment similar to that along the present Atlantic Coast. Changes in sea level due to glacial fluctuations and/or slight crustal movements have caused the alternating emergence and submergence of portions of this surface at irregular intervals. When submerged, the area collected deposits of continental and marine sediments. Each successive emergence resulted in shoreline modifications upon the newly emerged coastal area and the development of surface drainage on the previously emerged lands further inland.

The base area is mostly upland plains which include parts of three topographic surfaces, representing three periods of geologically recent land emergence. The Pamlico surface lies at elevations 2 to 25 feet in a 2 mile strip near the coast and along New River and other streams. The inland boundary of the Pamlico is a gentle scarp (Suffolk) that can be traced on aerial topographic maps. The majority of the base is on the Talbort surface which lies at elevations of about 30 to 45 feet. The Penholoway surface may be represented by a few areas south of Jacksonville at elevations of 50 to 70 feet.

These topographic surfaces have been dissected and drained to some extent by New River and its tributaries. The larger creeks and branches commonly are about 10 to 20 feet below the adjacent uplands.

Drainage is best on the higher elevations south of Jacksonville and in strips along larger streams. Otherwise, the terraces are poorly drained and contain large upland swamps.

The coastline is a relatively uniform sand ridge about 200 to 500 feet wide and typically about 5 to 15 feet in elevation. Shifting sand dunes on the ridge reach elevations of 25 to 40 feet. The sand ridge protects the mainland from wave action and it impedes tidal action and drainage from the mainland. Drainage from the area passes through New River, Browns Inlet and Bear Inlet into the Atlantic Ocean.

Tidal flats occupy irregular strips behind the coastal sand ridge, pockets along the shore at the sound and lowlands along the estuaries draining into the sounds.

This area of the Coastal Plain is underlain by hundreds of feet of unconsolidated to weakly consolidated sediments ranging from Cretaceous to Miocene in age. Generally these formations are covered with a 5 to 30 feet surface layer of Pleistocene sediments. The sediments are mostly clean sand and clayey sand, interlayered with deposits of clay and marine shells. On some of the poorly drained upland areas, thick organic soils have developed since emergence. Locally, on the banks of large streams, outcroppings of the Miocene Yorktown Formation can be found. The Yorktown consists of clay, sand and shell marl beds—similar to the younger surficial deposits. The Coastal Sand Ridge is primarily of wave-washed beach sand, but assorted sediments as described above probably occur at shallow depths under the ridge.

2. Climate - Located just below the 35th parallel of latitude, Camp Lejeune has a mild climate. The summers are usually hot and humid. Winters are fairly mild with temperatures frequently dropping below freezing. Snow is the exception rather than the rule. Annual precipitation averages 47 inches while the average temperature is 61°. There is a long growing season of approximately 230 days.

Rainfall variation and distribution by month for two years:

<u>Year</u>	<u>Annual</u>	<u>Jan</u>	<u>Feb</u>	<u>Mar</u>	<u>Apr</u>	<u>May</u>	<u>Jun</u>	<u>Jul</u>	<u>Aug</u>	<u>Sep</u>	<u>Oct</u>	<u>Nov</u>	<u>Dec</u>
1940	45.2	3.2	5.7	1.9	2.4	3.2	5.1	1.4	14.1	1.9	1.4	1.8	2.9
1946	72.1	3.8	3.0	2.1	3.5	4.2	4.3	19.1	10.3	12.3	4.5	2.7	2.1

Approximate average temperature (Fahrenheit) by month:

January	46°	May	69°	September	75°
February	47°	June	77°	October	65°
March	53°	July	79°	November	58°
April	61°	August	79°	December	49°

RAINFALL INTENSITY - FREQUENCY\*

Precipitation in Inches for Time Intervals:

<u>Frequency</u>	<u>5 Min.</u>	<u>10 Min.</u>	<u>15 Min.</u>	<u>30 Min.</u>	<u>60 Min.</u>	<u>120 Min.</u>
2-year	.48	.80	1.00	1.35	1.75	1.90
5-year	.53	.95	1.20	1.75	2.25	2.50
10-year	.60	1.05	1.38	2.00	2.60	3.25
25-year	.72	1.15	1.55	2.30	3.10	4.00
50-year	.80	1.30	1.75	2.50	3.60	4.50
100-year	.85	1.42	1.92	2.80	4.10	5.25

\*A rainfall intensity-frequency table prepared from data taken from US Department of Agriculture, Miscellaneous Publication No. 204, by David L. Yarnell.

3. Vegetation - The existing vegetation on most of the area resembles the ecological combinations of plant cover that can grow on the kind of soil in this climate. Variation in soils is the main cause of the wide variations of vegetation. Where the kinds of soil are loamy, the vegetation is dense and growing well; the trees are chiefly loblolly pine. Where the soils are sandy and have hard pan subsoils, the vegetation is sparse and non-vigorous consisting mostly of longleaf pine and scrub oaks. In depressions where the soil is muck, the vegetation is dense shrubs and a few large trees. Some interstream areas have undulating surfaces and deep sand soils. On the mounds in these areas the vegetation is very sparse and slow growing. In the sinks or small depressions the vegetation is dense shrubs. Trees are chiefly longleaf pine and scrub oak. On the east side of the mainland between elevations of 2 and 25 feet, soils are smooth and sandy and vegetation is moderately dense and growing well. The trees are chiefly loblolly.pine. In the drainageways, not affected by tidal action, vegetation is very dense and vigorously growing. Trees occurring in the drainageways are deciduous species. The tidal flats have less than 10 percent tree canopy and the vegetation is marsh grasses. Sparse stands of myrtle shrubs and beach grasses are found growing on the dunes or sand ridges and in places inland of the dunes.

4. Wildlife Resources - Camp Lejeune's wildlife management program is designed to provide optimum environmental conditions for the wide variety of fauna that inhabit the base. Extensive habitat management practices such as the proper harvest of timberlands, prescribed burning, creation of food plots, maintenance of wildlife openings and the preservation of habitat occupied by native plant species have resulted in an abundant, healthy population of wildlife available for both consumption and nonconsumption use.

Under the wildlife management plan, the base has been divided into fifteen wildlife units featuring a particular game species within a unit. On each unit management emphasis is directed toward improving the habitat for the selected species. However, all other game and nongame species within the unit are given consideration in management.

Progressive improvement is expected under the plan since it is adjusted to meet the increasing needs of the public using the local fish and wildlife resources. The plan is compatible with the forest management plan and with other land uses on the base.

A wide variety of fresh and salt water fish species inhabit the fresh water ponds and streams, salt water bays and the Atlantic Ocean adjoining the base. Principal fresh water game species are largemouth bass, bluegill, robin, redear sunfish, warmouth, pumpkinseed, yellow perch, redbfin pickerel, jack pickerel and channel catfish. Salt water species include flounder, weakfish, bluefish, spot, croaker, whiting, drum, mackeral, tarpon, marlin and sailfish.

Fish management practices in fresh water ponds are programmed to produce optimum yields and insure continued harvest of desirable fish species for the sports fisherman. Eleven fresh water ponds totaling 33 acres are currently under management. Eight of these are natural ponds which provided very poor fishing before being reclaimed and put under management. They are now providing quality sports fishing.

5. Forest Resources - The policy of the Command is to maintain a sustained-yield, multiple-use forest management program that is compatible with military training requirements. This program correlates timber management with the best wildlife habitat possible; base recreational and natural study areas; and the aesthetic value of the forests.

Timber-producing areas are under even-aged management with the exception of those areas along major streams and in swamps. These areas are under a modified even-age management system so that maximum coordination and benefits may be given to wildlife management and erosion control. Also included within this modified management system are the roadside zones parallel to major transportation arteries running through the base; base archery range; Special Services bridle trails; Camp Lejeune Boy Scout area; areas surrounding Special Services recreation camp sites; and forested areas parallel and surrounding building complexes throughout the base. Smaller areas are managed for enhancement of endangered or threatened wildlife species, particularly the red cockaded woodpecker and the osprey.

Approximately 61,140 acres are under management at Camp Lejeune. Timber management methods and techniques are similar to those used on other large holdings in the surrounding areas. Wherever practical, natural regeneration is favored. The method followed to obtain natural regeneration is to leave 8 to 12 seed trees per acre in blocks of no larger than 50 acres at the time of the final harvest. Artificial reforestation is used on clearcut areas in blocks not exceeding 50 acres and on areas being converted into timber-producing lands after other non-productive uses. Management objectives provide for mixtures of pine-hardwood with ratios of 70% pine minimum on pine producing sites and a mixture of 90%-plus hardwood and 10% or less of pine hardwood-producing sites. During site preparation operations in seed tree and clear-cut areas, scattered clumps of mast-producing and fruiting hardwoods are left to produce food for wildlife. Older stands are thinned to provide ample sunlight for increased vegetative growth.

The Camp Lejeune forest is divided into 62 compartments and each compartment into stands. Six compartments receive annual silvicultural treatments. A prescription for each compartment modifying the long range management plan, is prepared by a professional forester. These prescriptions take into consideration the following land uses:

- a. Military Training
- b. Timber Production
- c. Wildlife Habitat and Production; Possible Fish Pond Sites
- d. Recreation

After completion of prescription work, timber stands requiring treatment are marked and products are advertised for public sale. Other stand treatments are applied as necessary.

Benefits derived from forest management include wood production, increase of wildlife populations, enhancement of natural beauty, soil protection and prevention of stream pollution and protection of endangered wildlife species.

6. Recreational Resources - The Maintenance Section, Base Special Services has the responsibility of maintaining the recreational facilities at Camp Lejeune. Maintenance areas include the stables, the archery range, Gottschalk Marina, the skeet and trap range, Onslow Beach recreational area, two major camp sites and the athletic fields at Camp Lejeune. This plan is designed to provide guidelines and identify specific areas needing treatment for proper grounds maintenance at these recreational facilities.

7. Roads and Railroads - The location of Camp Lejeune makes it easily accessible by three major highways. They are NC Highway 172, NC Highway 24 and US Highway 17. NC 172 traverses Camp Lejeune from Sneads Ferry to Hubert and is the only state highway going through the base. It parallels the Atlantic Coast from Sneads Ferry to Bear Creek, then turns in a northerly direction and intersects NC Highway 24. NC 24 is essentially the northern boundary of Camp Lejeune. The main gate of the base is on NC 24 at Midway Park. This highway is a major tourist route for Onslow County. US Highway 17 parallels the western and southwestern boundaries of the base. The main gate of Camp Geiger is located on US 17 and the main service road for the Marine Corps Air Station at New River intersects this highway. US 17 is one of the major tourist and commercial travel routes in eastern North Carolina.

The Helicopter Outlying Landing Field, Oak Grove is located in Jones County on Secondary Road Number 1121. This is a rural road between US 17 and NC 58 west of Pollocksville.

There are two mainline railway systems serving Camp Lejeune under lease agreements with the US Government in effect until 1984. They are the Seaboard Coastline Railroad Company and the Southern Railway Systems. The Seaboard Coastline track enters the base on the northern boundary at Tarawa Terrace. At a point southeast of the main gate it forms a junction with the Camp Lejeune Railroad track and the base industrial area spur track. Camp Lejeune Railroad is owned by the US Government and leased to the Southern Railway Systems. It runs northeastward from Camp Lejeune to the US Marine Corps Cherry Point Air Station at Havelock, North Carolina.

The highway and railway systems provide a high quality transportation network for the base.

#### E. CONSERVATION PROBLEM AREAS

1. Erosion - Soil erosion continues to be a basic problem and presents the need for a concentrated treatment program on the base. Unstable soil conditions, steep slopes, poor



vegetative cover and inadequate water management facilities are causing the loss of soil by erosion. Active erosion is occurring in many of the drainageways along roads where water has been directed onto highly erodible soils. Soil washed from roadside ditches causes pollution of the streams and in many instances interferes with natural drainage. This problem is aggravated along several main roads and tank trails by the practice of using roadside ditches as trails for tracked vehicles. Erosion is generally more severe on the steeper slopes.

Soil losses on the powerline right-of-ways are due to slope and poor vegetative cover. Vegetation is limited to native plants that are adapted to droughty, infertile sites. Chemical and mechanical vegetative controls are used without much regard for providing ground cover sufficient to restrain soil erosion.

Borrow areas and sites of former facilities, although small in number, represent a significant sediment source. Little regard for the disposal of storm water runoff and little or no attempt to establish adapted vegetation generated sheet and gully erosion on these sites.

Amphibian vehicles landing along the coastal beach area and the river shoreline have destroyed the natural vegetation in the immediate landing sites. These sites are highly erosive and soil conditions make re-establishment of vegetation difficult.

2. Pollution - Responsibility and organization for environmental protection is established in Base Order 11080.2, subject Management of Natural Resources; Environmental Quality and Pest Control and Base Order 11090.1, subject Spill Prevention, Containment and Countermeasure Plan for Oil and Other Hazardous Substances.

The Assistant Chief of Staff, Facilities, exercises staff control over all matters pertaining to environmental protection while the Base Maintenance Officer has direct responsibility for management of environmental affairs. Management is accomplished primarily through the Natural Resources and Environmental Affairs Division of the Base Maintenance Department. However, other divisions of Base Maintenance also provide significant contributions.

(a) Air Pollution - The base has never had major air pollution problems. Located far from any large industrial center, there are few sources of air pollution for the area. The existing possible sources of air pollution are mainly the eleven steam generating plants on the base. The central heating plant, designed to burn coal or fuel oil, produces approximately 75% of all the heating energy for the base. Ten plants burn fuel oil.

(b) Soil and Water Pollution - The Utilites Division, Base Maintenance Department is charged with the responsibility of providing the base with good quality potable water. Nine water treatment plants serve the various geographical areas of the base providing approximately ten million gallons of potable water per day. Deep wells provide a source of water for the treatment to remove the hardness producing minerals. The softened water is then filtered, chlorinated, and pumped to the distribution system. Sewage effluent is a potential source of water pollution at Camp Lejeune. The sewage treatment complex consists of eight sewage treatment plants and fifty-six lift stations with a total design capacity of 14,095,000 gallons per day. Secondary treatment is accomplished at all eight sewage treatment plants. The rotating trickling filters at each facility provide approximately 90% efficiency in relation to biochemical oxygen demand and suspended solids. Coliform bacteria removal approaches 100% with

the passage of the effluent through a continuous feed chlorine contact chamber before emptying into New River. Pollution from oil continues to be a potential problem as large quantities of petroleum products are delivered daily to the base by truck or rail. The fuel is stored in underground tanks and in properly diked surface tanks and fuel bladders. No major oil spills have occurred in the offshore or inland waterways; however, a few minor accidental spills have occurred at storage facilities and refueling stations. Steps have been taken to eliminate this problem. Other minor oil spills have occurred around maintenance areas, motor pools, etc. Solid waste disposal is a laborious and expensive operation as approximately 700,000 cubic yards of garbage and other waste must be disposed of at the landfills each year. Waste of all kinds is transported to the sanitary landfill for disposal.

F. ACREAGE ANALYSIS \*

Marine Corps Base		
Improved Grounds		8,362 7,307
Semi-improved Grounds		5,014 7,193
Unimproved Grounds		
Woodland	60,093	
* Roadside Zones and Streams ✓	2,523	
Tidal Marsh	<del>3,326</del>	
Coastal Beaches	<del>1,645</del>	
Wildlife Food Plots	<del>285</del>	
* Impact Areas	5,447	
Total		73,319
Total Land Area		86,695
Water		25,764
Total		112,459

\*Acreage for Marine Corps Air Station, New River and HOLF, Oak Grove are included.

1. Improved Areas - These areas are primarily the cantonment area of troop and family housing buildings, hospital and medical buildings, administrative buildings, warehouses, community buildings and all other buildings associated with the official functions of the base. Intensively maintained cantonment areas such as lawns, parade grounds, drill fields, recreational fields, and major road berms together with the less intensively maintained areas such as firing ranges, magazine areas and utility right of ways are also included in improved areas. To protect these areas and to facilitate their use, the establishment, and management of vegetative cover and adequate erosion control measures must be an integral part of planning.

2. Wildlife Food Plots - These are areas 5 to 6 acres in size that have been cleared for annual planting and cultivation of crops that are suitable for a supplement to the natural available food for most species of wildlife.

3. Impact Areas - Impact areas have a single use in that they are used only for the impact of all types of firing that may range from small arms to 155 mm guns or even aerial ordnance. However, such wildlife as deer will forage in impact areas but no hunting is allowed due to the hazard of unexploded ordnance.

G. NATURAL RESOURCES AND ENVIRONMENTAL AFFAIRS DIVISION

The Base Maintenance Officer has staff responsibility for the management of all natural resources. The management is accomplished primarily through the Natural Resources and Environmental Affairs Division of the Base Maintenance Department. However, other divisions of Base Maintenance also provide significant contributions. Branches within the Natural Resources and Environmental Affairs Division include Forestry, Fish and Wildlife, Soil, Water and Environment, and Advisory and Data Input. This organization is new and a further refinement has been restructured as depicted below:

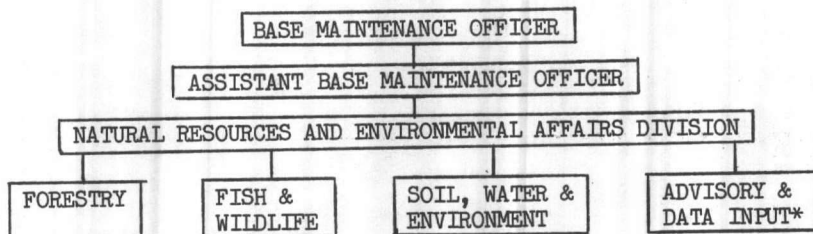

\*This section consists of advisory and coordination personnel from Base Public Works Department and other divisions of Base Maintenance Department on a collateral duty basis.

H. COMMITTEE FOR ENVIRONMENTAL ENHANCEMENT

Base Order 11015.2, which gives authority for this committee, was updated in 1973. In rewriting the order, the name was changed from "Committee for the Conservation of Natural Resources" to "Committee for Environmental Enhancement." The only major change was to reduce the membership from sixteen to six but retaining the original ten as advisors. Membership is as follows: Chairman (as appointed by the Commanding General); Director, Natural Resources and Environmental Affairs Division; Base Wildlife Manager; Representatives from - 2d MARINE DIVISION, FMF, and FORCE TROOPS; FMFLANT; and President, Rod and Gun Club. Advisors: Foresters; Ecologist; Game Protector; Veterinarian; Special Services Officer; Maintenance Officer; Provost Marshal; Training Facilities Officer; Design Director, Public Works Officer; and Director for Environmental Health.

This committee, originally established in 1962, assists and advises the Commanding General on matters pertaining to the conservation and management of natural resources and environmental enhancement. Responsibilities of the committee encompass general cognizance over any phase or facet of the Natural Resources Conservation Program with recommendations provided to the Commanding General for implementation, instructions, procedures, regulations and programs. These responsibilities are:

1. Conduct annually a comprehensive review of the base hunting, fishing, boating and trapping regulations and make recommendations to the Commanding General regarding changes, additions, or deletions.
2. Review recommendations submitted by the Rod and Gun Club regarding organized deer hunts, and make appropriate recommendations to the Commanding General regarding same.

3. Prepare annually for the Commanding General's approval a schedule and procedures for conducting organized and controlled hunts for all types of wildlife.

4. Prepare annually for the Commanding General's approval a schedule for open seasons and bag and creel limits in consonance with current federal, state and county laws and regulations.

5. After consultation with federal, state and county fish and wildlife authorities and officially chartered conservation agencies, make recommendations to the Commanding General regarding annual harvest of fish and wildlife on the base.

6. Provide command liaison and establish procedures for scheduling and conducting frequent meetings between representatives of federal, state and county fish and wildlife agencies and officially chartered conservation organizations. The committee will take the initiative to seek out help and to work effectively and in harmony with the above agencies and/or organizations. A full report of such meetings will be included in the minutes of the committee.

7. Ensure, when feasible, that local sportsman groups are invited to attend meetings of the committee as guests. The importance of establishing, maintaining and improving base community relations cannot be over-emphasized.

8. Review annually the cooperative plan between the base, the Regional Director of the US Fish and Wildlife Service and the Executive Director, NC Wildlife Resources Commission and make recommendations to the Commanding General for any desirable changes in the Wildlife Management Plan.

9. Monitor and make frequent reports to the Commanding General concerning all aspects of the Base Wildlife Food Plot Program.

10. Act as command representatives for any inspecting individual or group visiting the base in connection with the Natural Resources Conservation Program.

11. Establish and maintain procedures for accumulating reporting information and prepare all reports for the Commanding General regarding the Base Natural Resources Conservation Program, as required.

12. Develop for promulgation a continuing informational program designed to inform military and civilian persons alike of philosophies, principles, and policies of the Secretary of the Navy as related to the conservation program.

13. Recommend to the Commanding General Supplementary instructions, procedures, regulations, etc., regarding any phase or facet of the Natural Resources Conservation Program.

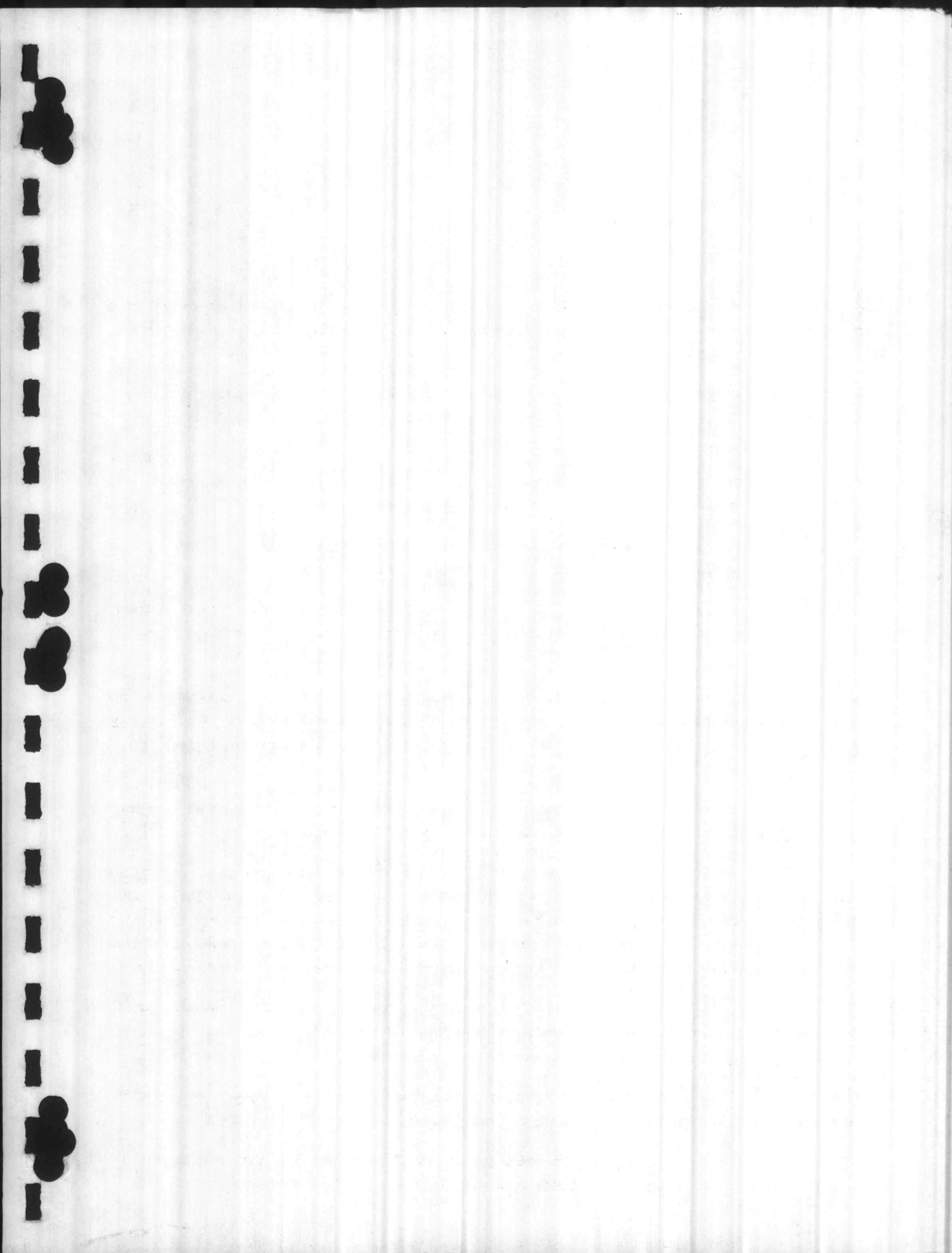



# GROUNDS MANAGEMENT

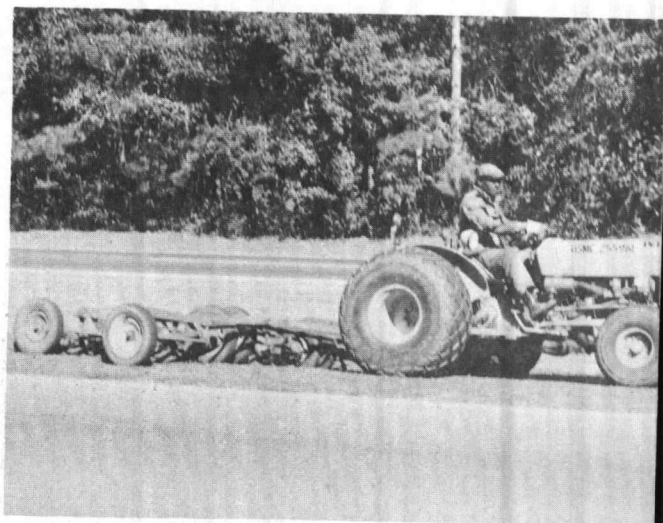

GROUNDS MAINTENANCE

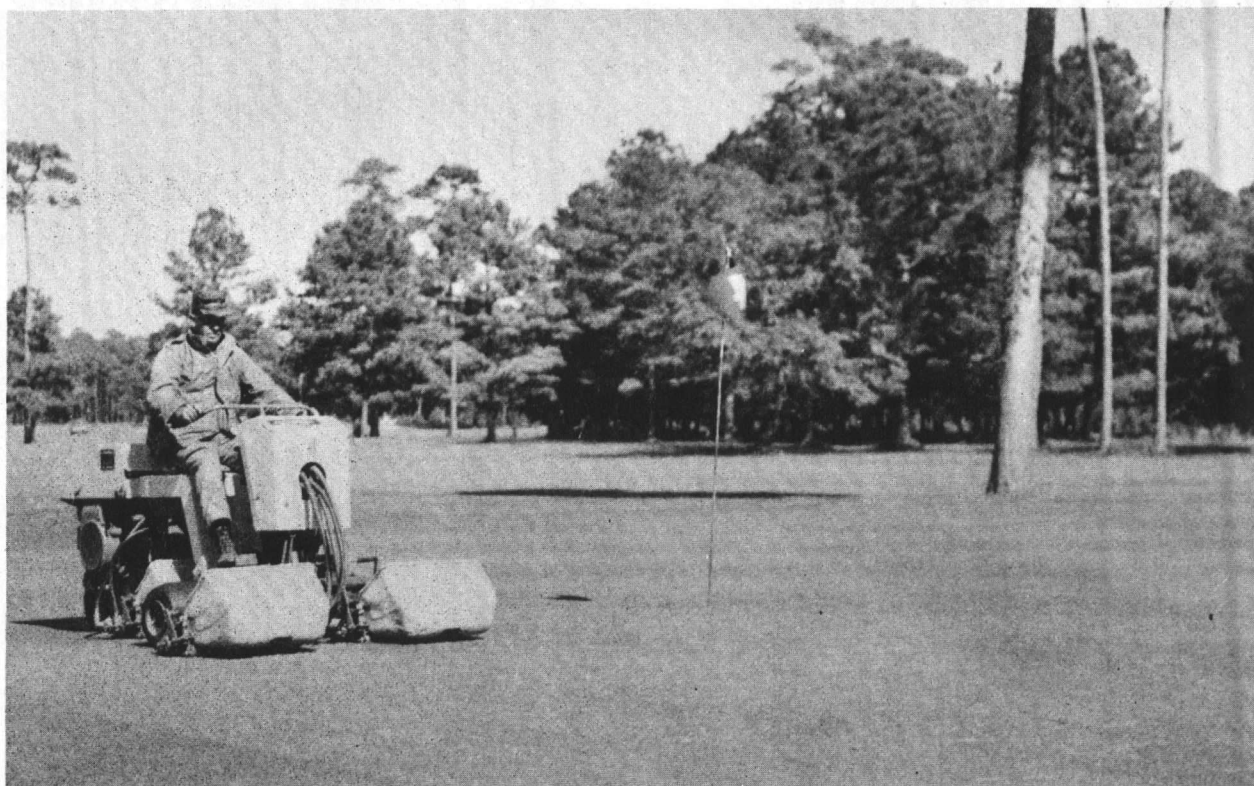

# IMPROVED GROUNDS MANAGEMENT PROGRAM

This program initiates a ten year plan for improving and maintaining ground covers and shrubbery. Emphasis will be directed toward low cost treatment of the lawn areas and roads taking into account the need for a quality environment that is aesthetically pleasing to the public.

Grounds improvement and maintenance at the base are divided into three broad treatments: recurring maintenance, new maintenance and landscaping. The grounds improvement and maintenance program is before the public eye more than any other phase of maintenance; therefore, pleasing the public's feeling for aesthetic beauty as well as taking into account maintenance cost is important.

The objectives of this plan are to reduce recurring maintenance cost, to identify and control erosion on critically eroding areas, to maintain and conserve desirable landscape planting, to landscape new buildings at a minimum cost and to reduce pollution of all types in order to assure a more attractive environment on lands at Camp Lejeune.

## A. LAWNS

1. Lawns add to the beauty of trees, shrubs and flowers, prevent erosion and protect buildings from dust. Establishing and maintaining lawns is a year-round job requiring considerable time, planning and treatment. Specific principles must be included in this plan to meet the objectives established. These are: (a) select and establish adapted lawn grasses, giving consideration to intensity of use, site conditions (soil types), and maintenance needs; (b) follow a regular maintenance schedule, adjusting the amount of lime and fertilizer applied in accordance with the fertility of the soil, growing season of the grasses and the use; (c) mow the lawns properly without weakening the grass; (d) use a prostrate type of growth during prolonged drought periods; (e) plan for the control of weeds that will kill the weeds without injuring the desired grass; and (f) maintain the lawn through a sound grass management program and the use of appropriate fertilizers.

2. Adapted Lawn Grasses. There are six species or kinds of lawn grasses that are adapted to the areas - climate and soil type: (a) centipede grass (*Cynodon dactylon*); (b) bermudagrass (*Cynodon dactylon*); (c) bahiagrass (*Paspalum conjugatum*); (d) St. Augustine grass (*Stenotaphrum secundatum*); (e) zoysia grass (*Zoysia tenuifolia*); and (f) carpetgrass (*Axonopus compressus*). These grasses are green and growing from late spring to mid fall.

a. Centipede grass. This grass grows on the poorest of sites and needs maintenance less than other lawn grasses. It will grow in full sunlight and partial shade. It spreads by above-the-ground runners and can be established by planting the runners (sprigs) or seed. With seed and proper care, a good sod can be established in one growing season. Sprigs are slower and usually require two years to acquire a good turf. Centipede thrives on soils in the pH range of 5.5 to 7.0. High levels of phosphorous are harmful and fertilizers which are low in phosphorous should be used. One moderate fertilization of high nitrogen fertilizer per year is sufficient for mature grass. Mowings will be about three weeks apart to a height of one to one half inches.



b. Bermudagrass have several varieties, but common bermudagrass is the most practical choice for lawns. Growth is very fast and a full cover can be obtained in one growing season from seeds. It spreads by runners above ground and rhizomes below the ground. Bermudagrass has a high resistance to wear and weather damage. It requires sunny locations, high amounts of nitrogen and liberal fertilization. Mowing should be weekly during the growing season to a height of 1 to  $1\frac{1}{2}$  inches.

c. St. Augustine or Charlestonegrass is a lush wide-bladed species which spreads by above ground runners. It is well adapted to shade and is therefore, the best choice for shaded housing locations. The vigorous growth makes a dense mat which chokes out undesirable weeds. It is subject to chinch bug damage and must be checked regularly for their presence. It is best suited to well or somewhat poorly drained sites of moderate fertility. Establishment is by sprigs only and maintenance mowing should not be closer than  $1\frac{1}{2}$  inches.

d. Bahiagrass is a species native to South America. The two varieties adapted to this area are 'Pensacola' and 'Wilmington'. Wilmington is more cold hardy and makes a tighter sod than Pensacola. Bahia will grow on deep sandy soils and somewhat poorly drained sites. Fertility requirements are low and its tolerance to acidity is high. Seeds are borne in a "V" shaped seed head. Seed heads appear in late June and reappear soon after mowing throughout the summer. The grass is disease free, traffic resistant and requires little maintenance other than mowing. Mowing height should be from 1 to  $1\frac{1}{2}$  inches.

e. Zoysia or Manillagrass has a very fine dark green blade and forms a dense mat. It spreads slowly from above ground runners and rhizomes. It is moderately drought tolerant and must be mowed every seven to ten days. Mowing height should be 1 to  $1\frac{1}{2}$  inches. The thatch of dead clippings which accumulates must be removed each spring. The grass is established by sprigging. It grows slowly and takes two to three years to obtain a good cover. It grows in full sunlight or partial shade. All varieties of zoysia are resistant to wear and disease.

f. Carpetgrass is a low growing, wide-bladed, creeping grass that is adapted to wet sites. It spreads by runners, lacks drought tolerance and has an open noncompetitive growing habit. These characteristics make it a poor choice for quality lawns. Establishment is by seeding and a full cover may be obtained in one growing season. Competition from weeds must be eliminated for a close stand. The production of tall seed heads that are difficult to mow give lawns a rugged appearance. Mowing should be done weekly to a height of 1 to  $1\frac{1}{2}$  inches.

g. A lawn is not difficult to establish if a few key points are remembered: (1) prepare a good seedbed; (2) select a suitable grass variety to the location; (3) use tested seeds or certified sprigs at the recommended rate; and (4) supply adequate fertilizer and water. A soil test should always be taken before an attempt is made to establish a lawn. The following table gives the essential management data for the adapted lawn grasses.

# IMPROVED GROUNDS MANAGEMENT PROGRAM

This program initiates a ten year plan for improving and maintaining ground covers and shrubbery. Emphasis will be directed toward low cost treatment of the lawn areas and roads taking into account the need for a quality environment that is aesthetically pleasing to the public.

Grounds improvement and maintenance at the base are divided into three broad treatments: recurring maintenance, new maintenance and landscaping. The grounds improvement and maintenance program is before the public eye more than any other phase of maintenance; therefore, pleasing the public's feeling for aesthetic beauty as well as taking into account maintenance cost is important.

The objectives of this plan are to reduce recurring maintenance cost, to identify and control erosion on critically eroding areas, to maintain and conserve desirable landscape planting, to landscape new buildings at a minimum cost and to reduce pollution of all types in order to assure a more attractive environment on lands at Camp Lejeune.

## A. LAWNS

1. Lawns add to the beauty of trees, shrubs and flowers, prevent erosion and protect buildings from dust. Establishing and maintaining lawns is a year-round job requiring considerable time, planning and treatment. Specific principles must be included in this plan to meet the objectives established. These are: (a) select and establish adapted lawn grasses, giving consideration to intensity of use, site conditions (soil types), and maintenance needs; (b) follow a regular maintenance schedule, adjusting the amounts of lime and fertilizer applied in accordance with the fertility of the soil, growing season of the grasses and the use; (c) mow the lawns periodically at heights that will stimulate more prostrate type of growth without weakening the grass; (d) artificially water lawns during prolonged drought periods; (e) plan for the control of weeds, selecting chemicals that will kill the weeds without injuring the desired grasses; and (f) control disease and insects through a sound grass management program and the application of chemicals for specific attacks.

2. Adapted Lawn Grasses. There are six species or kinds of lawn grasses that are adapted to the areas - climate and soil types: (a) centipedegrass (*Eremochloa ophiuroides*); (b) bermudagrass (*Cynodon dactylon*); (c) St. Augustine or Charlestongrass (*Stenotaphrum secundatum*); (d) bahiagrass (*Paspalum notatum*); (e) zoysiagrass (*Zoysia matrella*) and (f) carpetgrass (*Axonopus affinis*). These grasses are warm season perennials, meaning they are green and growing from late spring to mid fall and brown in winter.

a. Centipedegrass - This species will take traffic abuse, grow on the poorest of sites and needs maintenance less than other lawn grasses. It will grow in full sunlight and partial shade. It spreads by above-the-ground runners and can be established by planting the runners (sprigs) or seed. With seed and proper care, a good sod can be established in one growing season. Sprigs are slower and usually require two years to acquire a good turf. Centipede thrives on soils in the pH range of 5.5 to 7.0. High levels of phosphorous are harmful and fertilizers which are low in phosphorous should be used. One moderate fertilization of high nitrogen fertilizer per year is sufficient for mature grass. Mowings will be about three weeks apart to a height of one to one half inches.

b. Bermudagrass have several varieties, but common bermudagrass is the most practical choice for lawns. Growth is very fast and a full cover can be obtained in one growing season from seeds. It spreads by runners above ground and rhizomes below the ground. Bermudagrass has a high resistance to wear and weather damage. It requires sunny locations, high amounts of nitrogen and liberal fertilization. Mowing should be weekly during the growing season to a height of 1 to  $1\frac{1}{2}$  inches.

c. St. Augustine or Charlestonegrass is a lush wide-bladed species which spreads by above ground runners. It is well adapted to shade and is therefore, the best choice for shaded housing locations. The vigorous growth makes a dense mat which chokes out undesirable weeds. It is subject to chinch bug damage and must be checked regularly for their presence. It is best suited to well or somewhat poorly drained sites of moderate fertility. Establishment is by sprigs only and maintenance mowing should not be closer than  $1\frac{1}{2}$  inches.

d. Bahiagrass is a species native to South America. The two varieties adapted to this area are 'Pensacola' and 'Wilmington'. Wilmington is more cold hardy and makes a tighter sod than Pensacola. Bahia will grow on deep sandy soils and somewhat poorly drained sites. Fertility requirements are low and its tolerance to acidity is high. Seeds are borne in a "V" shaped seed head. Seed heads appear in late June and reappear soon after mowing throughout the summer. The grass is disease free, traffic resistant and requires little maintenance other than mowing. Mowing height should be from 1 to  $1\frac{1}{2}$  inches.

e. Zoysia or Manillagrass has a very fine dark green blade and forms a dense mat. It spreads slowly from above ground runners and rhizomes. It is moderately drought tolerant and must be mowed every seven to ten days. Mowing height should be 1 to  $1\frac{1}{2}$  inches. The thatch of dead clippings which accumulates must be removed each spring. The grass is established by sprigging. It grows slowly and takes two to three years to obtain a good cover. It grows in full sunlight or partial shade. All varieties of zoysia are resistant to wear and disease.

f. Carpetgrass is a low growing, wide-bladed, creeping grass that is adapted to wet sites. It spreads by runners, lacks drought tolerance and has an open noncompetitive growing habit. These characteristics make it a poor choice for quality lawns. Establishment is by seeding and a full cover may be obtained in one growing season. Competition from weeds must be eliminated for a close stand. The production of tall seed heads that are difficult to mow give lawns a rugged appearance. Mowing should be done weekly to a height of 1 to  $1\frac{1}{2}$  inches.

g. A lawn is not difficult to establish if a few key points are remembered: (1) prepare a good seedbed; (2) select a suitable grass variety to the location; (3) use tested seeds or certified sprigs at the recommended rate; and (4) supply adequate fertilizer and water. A soil test should always be taken before an attempt is made to establish a lawn. The following table gives the essential management data for the adapted lawn grasses.

TABLE 1

## ADAPTED WARM SEASON GRASSES

	<u>Centipede</u> <u>grass</u>	<u>Common Bermudagrass</u>	<u>St. Augustine</u>	<u>Bahiagrass</u>	<u>Zoyziagrass</u>	<u>Carpetgrass</u>
	<i>Eremochloa</i> <i>ophiuroides</i>	<i>Cynodon</i> <i>dactylon</i>	<i>Stenotaphrum</i> <i>Secundatum</i>	<i>Paspalum</i> <i>notatum</i>	<i>Zoyzia</i> <i>matrella</i>	<i>Axonopus</i> <i>affinis</i>
Tolerance to foot traffic and wear	Low	High	Low	Low	High	Medium
Soil Preference	Well drained coarse-medium textured	Well to somewhat poorly drained coarse-medium textured	Well drained medium textured	Well to somewhat poorly drained	Well drained medium-fine textured	Somewhat poorly-poorly drained coarse textured
Shade Tolerance	Medium	Low	High	Medium	Medium	Medium
Water Tolerance	Low	Medium	Medium to high	Medium	Low-medium	High
Drought Tolerance	High	High	Low	Medium	High	Low
Optimum pH Range	5.5 - 6.0	6.5 - 7.0	6.5 - 7.0	6.5 - 7.0	6.5 - 7.0	5.5 - 6.0
Fertility Requirements	Low	High	Medium	Low	Medium	Low
Method of Propagation	Seed-vegetative	Seed-vegetative	Vegetative	Seed	Vegetative	Seed
Optimum Propagation Period	May-June	April-May	April-May	April-May	May-June	April-May
Pounds of Seed per 1000 sq. ft.	1/4 lb.	2 lbs.	-	2 lbs.	-	3 lbs.
Bushels, of Sprigs per 1000 sq. ft.	1/2 - 3/4 sq. yd.	1/5 - 1/3 sq. yd.	3/4 - 1 sq. yd.	-	1/6 - 1/4 sq. yd.	-
Annual Fertilization Pounds per acre for Medium Management	70-70-70	100-25-50	80-20-40	70-70-70	80-20-40	70-70-70
Annual Fertilization Pounds per acre for High Management	100-100-100	160-40-80	120-30-60	100-100-100	120-30-60	100-100-100
No. Fertilizations Annually	1	5 - 6	4 - 5	2	4 - 5	2
Frequency of Fertilizing (weeks)	-	4 - 6	6 - 8	12 - 14	6 - 8	12 - 14
Date of First Annual Fertilization	April 1	April 1	April 1	April 1	April 1	April 1
Height of Cutting (inches)	1 to 1 1/2	3/4 to 1 1/2	2 to 2 1/2	1 - 2	3/4 to 1 1/2	1 - 2
Frequency of Cutting (days)	14 - 21	5 - 10	10 - 14	5 - 10	5 - 10	5 - 10

3. Lime and fertilizer are important items in producing and maintaining healthy and attractive lawns. Ample lime and the correct analysis fertilizer applied at the correct time and rate is essential for lawn maintenance. This requirement varies with different grass as use and natural fertility of the site.

Most of the soils are too acid to grow good grass unless corrected by liming. Even though some grasses are more tolerant of soil acidity than others, the adverse effects of soil acidity are expensive compared to the simplicity of correction. Lime should be applied during seedbed preparation in accordance with the recommendations of a soil test. After establishment and as regular maintenance, liming should be done periodically at amounts adequate to forestall serious acidity problems. Making a soil test at least every three years should provide an accurate guide to treatment needs. Apply lime during the fall for the desired effects during the following summer growing season.

Either inorganic or organic nitrogen fertilizer may be used for maintaining lawns. Organic nitrogen gives more uniform stimulation to grass over a longer period of time. Cost is higher for organic nitrogen. Nitrogen is the growth regulating element that produces the rich green color in lawn grasses. Since it cannot be stored by the plant or in the soil for any length of time, it must be applied several times annually.

Warm season grasses normally respond favorably to a 4:1:2 to 4:1:3 ( $N:P_2O_5:K_2O$ ) ratio fertilizer. Most of these grasses require phosphorous and potash in the spring and fall for healthy growth and minimum cold damage during winter. Centipede, carpet and bahia are low-fertility grasses and one application of phosphorous and potash at the start of the growing season is sufficient. The time interval between N applications depends on the type of nitrogen fertilizer being used and the quality of turf desired. Large applications of N during the late growing season will be avoided. The soil test taken every three years on all lawn areas will provide guidance in the proper amounts of plant nutrients to be applied.

4. Mowing - Scheduling of a mowing program for an area as large as Camp Lejeune is an important part of the lawn maintenance program. The objective of the schedule is that no more than  $\frac{1}{4}$  to  $\frac{1}{2}$  of the total leaf surface is removed at one mowing. This can generally be accomplished by setting all mowers to cut at a height of  $1\frac{1}{2}$  inches. Mowing will be done when the grass and soil are dry to prevent lawn diseases. Whenever possible, the removal of clippings is desirable. Proper application of fertilizer and periodically mowing will greatly reduce thatch accumulation. Removal of thatch will be done as needed.

5. Irrigation is not normally required in this region of the state. There are special cases when irrigation is necessary to reduce drought injury, to assure good germination and/or development of a full cover of grass. In these cases, apply with a sprinkler that will not pack the soil or cause erosion of the area from too rapid an application. Apply the water no faster than the soil can take it up and wet the soil thoroughly to a depth of six inches at each sprinkler setting. Lighter more frequent waterings will promote the growth of shallow rooted annuals such as crabgrass and annual weeds.

6. Weed Control - Emphasis in the annual spray program will be the control of broadleaf weeds. The strategy of weed control consist of properly managing a healthy and dense grass sod

TABLE 3

Plants to be purchased and produced for landscape improvement and maintenance:

<u>BOTANICAL NAME</u>	<u>COMMON NAME</u>	<u>NUMBER</u>
1. Abelia grandiflora	Glossy Abelia	500
2. Aucuba japonica	Japanese Aucuba	800
3. Camellia japonica	Camellia	1,500
4. Camellia sasanqua	Fall Flowering Camellia	2,300
5. Cedrus deodara	Deodar Cedar	1,200
6. Chaenomeles japonica	Floweringquince	800
7. Euonymus japonicus	Evergreen Euonymous	900
8. Hibiscus syriacus	Shrubalthea	800
9. Gardenia jasminoides	Capejasmine	750
10. Hydrangea paniculata	Hydrangea	920
11. Ilex cornuta	Chinese Holly	1,400
12. Ilex cornuta (burfordi)	Burford Holly	2,000
13. Ilex (rotunda)	Dwarf Holly	800
14. Ilex crenata (mariesi)	Boxleaf Holly	1,500
15. Ilex crenata (helleri)	Helleri Holly	600
16. Ilex crenata (rotundifolia)	Roundleaf Holly	400
17. Ilex cassine	Dahoon	900
18. Ilex cassine (angustifolia)	Narrowleaf Dahoon	400
19. Ilex cassine (myrtifolia)	Myrtle Holly	900
20. Ilex opaca	American Holly	1,000
21. Ilex opaca (species)	American Holly	950
22. Ilex vomitoria	Dwarf Yaupon	800
23. Jasminum nudiflorum	Showy Jasmine	1,300
24. Jasminum nudiflorum	Winter Jasmine	1,700
25. Juniperus chinensis (phitzieriana)	Pfitzer Juniper	1,600
26. Juniperus hibernica	Irish Juniper	900
27. Juniperus conferta	Shore Juniper	1,400
28. Juniperus sabina	Savin Juniper	1,800
29. Kolkwitzia amabilis	Beautybush	400
30. Lagerstroemia	Crapemyrtle	2,000
31. Ligustrum coriaticum	Crinkled Leaf	1,000
32. Ligustrum japonicum	Japanese Privet	1,800
33. Ligustrum lucidum	Glossy Privet	800
34. Ligustrum lucidum NANA	Glossy Dwarf	900
35. Mahonia aquifolium	Oregongrape	600
36. Myrica cerifera	Waxmyrtle	800
37. Nandina domestica	Nandina	1,200
38. Osmanthus ilicifolius	Holly Osmanthus	1,000
39. Osmanthus fortunei	Fortune's Osmanthus	1,500
40. Photinia franchetina	Franchet Photinia	1,200
41. Photinia glabra	Japanese Photinia	1,800
42. Photinia serrulata	Chinese Photinia	900
43. Pittosporum tobira	Pittosporum	1,850
44. Podocarpus macrophyllus	Podocarpus	2,060
45. Prunus glandulosa	Flowering Almond	400
46. Prunus laurocerasus	Cherry Laurel	1,200
47. Punica granatum	Pomegranate	900
48. Pyracantha koidzumi (formosana)	Formosa Firethorn	1,500
49. Spiraea thunbergi	Thunberg Spirea	200
50. Thuja occidentalis	Eastern Abonvital	1,800
51. Viburnum fragrans	Fragrant Viburnum	400
52. Viburnum tinus	Laurestinus	300
53. Azaleas		
Indian		
Formosa		2,800
Pride of Mobile		2,900
President Clay		1,200
Kurume		
Bridesmaid		1,800
Coralbells		1,400

<u>BOTANICAL NAME</u>	<u>COMMON NAME</u>	<u>NUMBER</u>
Hinodegiri		1,800
Pink Pearl		1,900
Snow		2,500
54. Obtusum	Amoenum	700

<u>SMALL TREES</u>	<u>COMMON NAME</u>	<u>NUMBER</u>
1. Cercis canadensis	Redbud	1,200
2. Cornus florida	Dogwood	1,000
3. Cornus florida rubra	Pink Dogwood	1,400
4. Cornus kousa	Japanese Dogwood	1,500
5. Koelreuteria paniculata	Golden Raintree	800
6. Magnolia stellata	Star Magnolia	900
7. Malus spp.	Flowering Crabapples	400
8. Prunus spp.	Flowering Cherries	470

C. MOWED AREAS OTHER THAN LAWNS

1. Many cleared areas require mowing and other treatment to maintain a good ground cover, but maintenance is less intense than that on the lawn areas. These areas include landing zones and training areas other than ranges, parade grounds, road berms and utility line right-of-ways.

2. Training and landing zones are areas that must be mowed periodically to control woody plants and growth that would interfere with aircraft. Many of these areas at present have wet soil conditions or holes where water collects during wet periods. Some of these areas also lack uniform cover and in most instance no specific variety of grass is dominant. Several of the areas need regrading to eliminate surface water ponding. Adapted grasses should be established and managed where ground covers are open and sparse. Many of these areas are included in the special treatment areas where specific treatment has been planned.

3. Parade grounds and road berms have a good cover on most areas. However, this cover consists mainly of broad-leaved weeds and several varieties of grass. Management is a problem because the weeds are often blooming and the grasses require different fertility rates and management practices. During the next ten years, these areas will be reestablished in adapted grasses and managed.

4. Power lines exist throughout the base. These lines run through mostly wooded areas and the right of ways are approximately 60' wide. The past management practice has been to let these areas grow up in small trees and brush until they were impassable. Then a bulldozer was scheduled to clear the areas. This has resulted in high maintenance cost in some cases, soil erosion and poor utilization of many areas for potential wildlife habitat. In the future all utility right-of-ways will be cleared and seeded to a perennial grass. Seeding will be done as a part of the clearing job order. The seeding materials used will be either fescue and sericea lespedeza or bahiagrass. The soil type and time of seeding will determine the materials used. This practice should convert all right-of-ways to potential grazing and nesting areas for wildlife. Future maintenance will be limited to mowing and fertilization. Mowing will be scheduled so that

it will not disturb nesting wildlife.

#### D. CHANNEL IMPROVEMENT AND STREAM STABILIZATION

1. Channel improvement and stream stabilization is a complex problem at Camp Lejeune. The soils of most drainageways and surrounding sideslopes are sandy in nature. This causes construction problems due to ditch sides caving during construction. These ditch banks are susceptible to erosion during peak flow periods of runoff from surface water entering the channel and high velocity flow within the channel. These erosion hazards need to be taken into consideration when drainage design work is drawn up on new projects. The incorporation of adequate vegetative cover in areas surrounding drains will be a part of the drainage work orders. This will include vegetation to filter sediment out of surface water and vegetation to stabilize spoil material.

2. Sod development along existing channels is needed in several areas. The major areas are those where land disturbing activities are taking place adjacent to drains. The development of a vegetative strip along these drains will reduce maintenance cost and prevent sediment pollution from entering the adjacent streams.

3. Channel lining with concrete or asphalt will be required in many areas. These are areas that have either larger volumes of flow than vegetative channels can safely handle or areas that have too steep a grade for vegetation to control the erosive force of the water. The improved grounds have several areas needing this type of treatment due to the large volume of runoff from roofs and paved areas.

4. Structural measures for grade control on channels are needed in many areas. These structures can be ordered preconstructed or designed and constructed for the individual site. All locations for such structures are a result of some type of development activity. In most areas these sites involve runoff from roads that have a steep drop off where they intersect drains. Other areas requiring this type of treatment are natural streams where the streams velocity has been greatly increased due to some type of land disturbing activity.

#### E. ROADSIDE STABILIZATION

1. Roadside stabilization has been carried out commendably in the past. There is now a need for this type of work at many spot locations. These areas are generally less than one-tenth acre in size. Many areas along the unpaved roads are in need of adequate surface drainage. These roads are presently being graded without a planned grade to drain these areas. The result is long stretches of standing water on the roads at certain locations. In many cases drains are near these areas, but the short ditches needed to drain these areas will not justify the use of a dragline. The addition of at least two backhoes to the Maintenance Department in the next two years will correct this situation. This additional equipment, together with a schedule covering the roads needing this work over the next ten years, will eliminate these drainage problems. The seeding of small areas along the roadside will be done using grasses or plants adapted to the particular site. Many of the areas now needing treatment are the result of trying to stabilize these areas with unadapted planting materials. The roads often travel through soils ranging in drainage from poorly drained to excessively drained. The use of one variety of grass or a mixture of grasses adapted to moderately well drained sites has



resulted in an incomplete stand in many small areas.

2. Structural measures needed for roadside stabilization and drainage include grade control structures, culverts, channel lining and ramping on tank trails. The location and amount of these various measures is included in the special treatment area. The rolling landscape together with a disregard for contours on laying out roads has resulted in severe erosion problems on some areas. This is particularly true in regard to tank trails and training roads where they intersect drainageways. These areas will require special treatment to prevent sediment pollution of these streams.

3. There is a general belief that many of the woodland roads can be graded and the drains and road shoulders seeded to prevent existing problems. A test road will be selected by Base Maintenance for this purpose. The roadbed will be reshaped and the side drains will be constructed to a planned grade. The side drains and an adjacent strip of the road the width of the seeder will be seeded and mulched. The road will then be evaluated to compare maintenance costs with the present practice of constant grading and cleaning out road drains.

#### F. AIR POLLUTION CONTROL

1. In June 1973 the Central Heating Plant was fuel converted to burn 100% No. 6 fuel oil and smoke detectors were installed in the smoke stacks at all heating plants.

2. With the advent of the fuel crisis, the Central Heating Plant now operates 50% coal-50% No. 6 fuel oil. Also, a spray down chamber for removal of particulate matter from smoke emission was installed at the commissary incinerator. Recently, however, with the installation of a 45-cubic yard container for cardboard, burning has been terminated in this facility.

#### G. SOIL AND WATER POLLUTION CONTROL

##### 1. Oil.

a. To prevent oil pollution problems, approximately 60 waste oil storage tanks have been modified and installed at different locations for utilization at the unit level. Personnel in each unit have been informed of ways to reduce oil spillage in their respective areas. Oil-contaminated soil in various locations has been replaced with new soil, reseeded and landscaped. Further work is planned in the future to improve appearance of the grounds around maintenance buildings and motor pools. In the past, most waste oil collected at Camp Lejeune was used for dust control on unpaved roads and parking lots. This practice has been approved by the Environmental Protection Agency. A 272,000-gallon tank is now available for storing excess waste oil that is not needed for dust abatement. This oil is expected to be used for heating fuel or reclamation. Base Order 11090.1 of 28 September 1972 contains in addition to command policy the Base Spill Prevention, Containment and Countermeasure Plan for Oil and Other Hazardous Substances. Marine Corps Bulletin 6240 of 28 August 1973 directs that certain oil containment and cleanup equipment to combat any possible oil spill must be on hand and available. Camp Lejeune has a boat, oil skimmer, vacuum truck, sorbent mats, straw and other equipment that can be used to contain and clean up oil spills. This equipment is located at Base Maintenance and upon notification can be transported to the site of an oil spill. Also, 600 feet of oil containment boom is on order.

b. Beginning January 1974, classroom time for a slide/lecture presentation on the environment was included as a part of the Motor Transport School Company, Montford Point, student training program. The base ecologist gives the presentations with special emphasis being placed on oil pollution and the pollution abatement program. By making each student more aware of environmental problems, it is felt more desirable habits and attitudes will be developed.

## 2. Sewage Treatment.

a. The Sewage Treatment Plants have their own laboratory where the sewage is analyzed to ensure that the effluents meet federal and state specifications. On 18 January 1974, the Environmental Protection Agency issued the National Pollutant Discharge Elimination System permits to Camp Lejeune authorizing the discharge of sewage effluent from all seven sewage treatment plants into receiving water. Camp Lejeune's discharge permits were among the first issued under the National Pollution Elimination System; a fact that speaks for itself as to the present condition of the discharges.

b. Starting 1 July 1974, sampling points established by the Environmental Protection Agency will be used to monitor those water receiving effluent from base sewage treatment plants. This sampling analysis and subsequent reporting will meet the requirements of the Environmental Protection Agency and the State of North Carolina.

c. To comply with Environmental Protection Agency regulations, the following proposals were made regarding Camp Lejeune sewage disposal:

- (1) Seal by-passes at all sewage lift stations and sewage treatment plants.
- (2) Provide high liquid alarm system at all outlying sewage lift stations and sewage treatment plants.
- (3) Provide standby power at all sewage treatment plants and lift stations.
- (4) Recycle sludge drying bed liquor at all sewage treatment plants.
- (5) Provide additional anaerobic digester at the Tarawa Terrace sewage treatment plant.
- (6) Provide four additional sludge drying beds at Tarawa Terrace sewage treatment plant.
- (7) Add a chlorine contact chamber at Tarawa Terrace sewage treatment plant.

d. Work on these projects is planned for FY 1975. This will further upgrade the sewage treatment facilities at Camp Lejeune.

## 3. Solid Waste Disposal.

a. The sanitary landfill is located on a well drained 40-acre site on Sneads Ferry Road. A large trench approximately 40 feet wide and 12 feet deep is excavated to receive waste material. A bulldozer is used to compact the refuse as it is placed in the trench. At the end

of each work day, the filled area is covered with soil, which eliminates insect attraction, fly breeding and rodent habitat.

b. Soon after the opening of the Sanitary Landfill, twenty-one compaction devices were installed in base messhalls. These devices exert a 10-to-1 compression ration. This makes them popular with mess personnel because they greatly reduce the laborious task of transporting refuse to waste containers. Basewide requirements of waste containers at messhalls have been reduced by half; the poundage per trip in the dumpmaster truck has been increased; and the space per pound in the Sanitary Landfill is substantially reduced.

4. Pesticides. All pesticides are controlled and dispensed through the Insect and Rodent Control Section under the Bse Maintenance Officer. Pesticides are locked in proper storage facilities and are dispensed only by or under the direction of certified pest controllers. The Base Medical Officer maintains general surveillance over the program.

#### H. SPECIAL TREATMENT AREAS

1. These areas are in need of some type of conservation treatment. Treatment needs range from erosion control and drainage to revegetation of some areas. The recommended treatment of these areas together with a cost estimate is included in this section. Treatment areas have been assigned Priority One, Two or Three according to their need for treatment. Priority One treatment areas are those which at present are hampering normal operations or areas which are contributing sediment or pollution to streams. Priority Two treatment areas are areas in need of treatment, but at present are not creating a significant problem to base operations and are not causing excessive pollution problems. Priority Two areas will become Priority One areas if some treatment is not applied in the near future. Priority Three treatment areas are those areas that do not require immediate attention; but if treated, maintenance costs would be reduced, wildlife habitat would be enhanced and the environment would be improved.

2. The riding trails on the base have many areas that are eroded. This is because the trails do not follow the contour, but instead go straight up steep slopes. The trails will be replanned to follow the contour of the area and the old gullies will be filled.



*Essential military vehicle training has had an adverse environmental effect throughout the area as seen by the above sediment pollution.*

Grid Location & Site Number	Priority	Site Description and Planned Treatment	Cost Estimate
787474 S-1	3	<u>Cemetery, Entrance to Camp Johnson.</u> Construct a "V" ditch to outlet NW of the depression where surface water stands. Establish and maintain perennial grass on the ditch berm and slopes.	\$ 110
801463 S-2	2	<u>North of Power Plant, Camp Johnson.</u> Install sand-cement bag headwalls at the culvert where the road crosses the stream. Grade the roadbed to drain from the top of the slope to the stream crossing. Establish and maintain perennial grass on the roadbed and in the drains. Mulch will be needed during establishment.	580
795465 S-3	2	<u>Power Line Through Woods, Camp Johnson.</u> Clear the power line right-of-way and establish and maintain perennial grass.	2,187
796465 S-4	2	<u>Stream Crossing, Power Line Right-of Way E of Road, Camp Johnson.</u> Install sand-cement bag headwalls.	270
791473 S-5	3	<u>Borrow Area NW of Power Plant, Camp Johnson.</u> Establish and maintain perennial grass.	29
785463 S-6	2	<u>Power Line and Training Road Intersection S of Camp Johnson Gate.</u> Construct a diversion to divert surface runoff into and down the power line road to the river. Shape the roadbed and regrade side drains on the training road from the top to the bottom of the hill. Establish and maintain perennial grass in the drains.	310
776460 S-7	1	<u>Old Training Area W of Camp Johnson, New River.</u> Construct a diversion. Establish and maintain perennial grass - bahia or bermudagrass.	743
793453 S-8	1	<u>Eroding Area Behind Building M 121, Camp Johnson.</u> Shape the sloping area. Establish and maintain perennial lawn grass. Keep foot traffic off the slope.	45
795452 S-9	1	<u>Camp Johnson Wash Rack Area Adjacent to SM 187, SM 173 and SM 195.</u> Construct an asphalt chute in drainage way. Locate the chute on the NE side of the road to Building SM 187. Runoff from the SM 195 area should enter the chute through a steel gate where vehicles cross the drain. Amphibious vehicles should use the ramp when landing and discontinue use of the steep banks.	3,800
785446-809453 S-10	2	<u>Old Trailer Park Site E of Camp Johnson and Shoreline Behind Building 231 at Camp Johnson.</u> Stabilize the shoreline with debris from old buildings being destroyed in the Industrial Area. Install rip-rap to the height of three feet along the shoreline. Install jetties to trap sand and build up a beach.	2,339
814453 S-11	2	<u>Road E of Camp Knox Trailer Park.</u> Establish and maintain grass on the road and utility right-of-way.	342
818452 S-12	2	<u>Old Naval Dock W Tarawa Terrace Sewage Treatment Plant.</u> Construct a diversion parallel to the shore to divert runoff into the concrete drain.	50
833466 S-13	1	<u>Play Area N of Tarawa Terrace Elementary School.</u> Construct a waterway from the low area where water ponds to the outlet at the road in front of the school. Grade the area to drain into the waterway. Establish and maintain perennial grass.	185

Grid Location & Site Number	Priority	Site Description and Planned Treatment	Cost Estimate
831465 S-14	2	<u>Waterway Behind Tarawa Terrace Elementary School.</u> Establish and maintain perennial grass.	\$ 130
838462 S-15	2	<u>Borrow Pit, W of NE Creek Bridge.</u> Construct a sediment basin at the NE end of the borrow pit using a 12" perforated riser pipe.	179
838463 S-16	1	<u>Gullied Area E of Tarawa Terrace Baseball Fields.</u> Install an asphalt chute to carry runoff from the baseball fields and adjacent road to the low area and outlet at the Creek. Fill and shape area. Establish and maintain perennial grass.	2,168
845456 S-17 (a)	1	<u>Heavy Equipment Area E Side.</u> Install grade control structure in ditch along fence. Construct a diversion on the east side of the ditch. Install drop inlet structures on both sides of the ditch. Establish and maintain perennial grass on the ditch spoil.	287
845456 S-17 (b)	2	<u>Heavy Equipment Area W Side.</u> Construct a diversion. Fertilize the established grass to improve the ground cover in the area where runoff outlets into the woods.	250
848450 S-18	1	<u>Utility Right-of-Way, Heavy Equipment Area to Brewster Blvd.</u> Establish and maintain bahiagrass on the right-of-way and in the borrow area. Shape the borrow areas where necessary to obtain good surface drainage. Fill the gullies on the south end of the right-of-way. Install an asphalt chute for disposal of runoff into the stream. Install sand-cement bag headwalls at the culvert.	6,390
827448 S-19	2	<u>Boy Scout Area, NE Creek.</u> Establish and maintain area around the scout cabin in adopted lawn grass. Install steps for access to the creek.	225
804432 S-20	3	<u>Behind the General's House.</u> Construct a diversion and grade the NW corner of the yard to divert runoff into the drop inlet structure.	81
868423 S-21	1	<u>Henderson Pond.</u> Close the road on the west side of the pond that leads to the water edge. Divert runoff from the road and into the woods between Henderson and Hickory Ponds. Slope and establish vegetation on the eroding areas, each end of the dam. Reestablish vegetation on the dam. Extend the spillway and toe drain outlet pipes twenty feet. Fill and slope the area around the pipe outlets. Extend the exist end of the asphalt spillway 130 feet, leaving the last 30 feet on a flat grade. Extend the outlet end of the asphalt one foot into the ground.	3,635
859428 S-22	2	<u>Old Sawmill Site S of Main Gate.</u> Divert the surface water runoff into the catch basin located at south end of the railroad. Grade the south end to drain toward the diversion. Establish and maintain perennial grass on the diversion.	152
851402 S-23	3	<u>E of Veterinarian's Lab.</u> Construct a diversion across the roadbed at the slope break.	100

Grid Location & Site Number	Priority	Site Description and Planned Treatment	Cost Estimate
846436 850435 845422 S-24, 25, 26	2	<u>Outlet Ditches for Storm Drains Around Berkeley Manor.</u> The eroding areas are to be filled, sloped and established in perennial grass. Install asphalt chutes inlets along the open ditches for removal of runoff. Designate these ditches as off limits.	\$ 400
850425 S-27	1	<u>Service Road SW side of Berkeley Manor.</u> Pave road section on the steep slope from the crest of the hill on both sides (approximately 300'). Install a catch basin in the low area above this section of road. Install an asphalt chute on lower side of the road to divert runoff.	1,389
852426 S-28	1	<u>Drainage Canal, E of Berkeley Manor.</u> Construct a storm water detention basin. See appendix for details on pipe size and design.	5,834
833395 S-29	1	<u>Area N of River Road Entering Hadnot Point.</u> Restrict traffic on the steep slope between buildings H-30 and H-31. Grade slope. Establish and maintain adopted lawn grasses. Mulch will be needed during establishment.	418
856365 S-30	2	<u>E of Hadnot Point Sewage Treatment Plant.</u> Install approximately 500' of drain tile along the SW side of the pond. Reestablish vegetation in the small bare spots on the N and E sides of the pond.	540
867379 S-31	1	<u>Dump Site N of 1800 Area.</u> Fill the gullies and shape the area. Install a 12" CMP drop inlet structure in the ditch. Establish and maintain perennial grass.	390
866376 S-32	1	<u>Bare Area W Side of Drainage Ditch N of 1800 Area.</u> Install a 12" CMP drop inlet structure. Shape the roadbed and rebuild the berm along the ditch.	226
878364 S-33	3	<u>Range E of Force Troops Complex.</u> Stabilize the front slope of the observation mound by establishing and maintaining vegetative cover of weeping lovegrass or bermudagrass.	120
870362 S-34	1	<u>Drainage Ditch, SE of Force Troops Complex.</u> Install a 24" culvert and sand-cement bag headwalls for vehicle crossing.	990
864366 S-35	2	<u>Border N Side of Force Troops Complex.</u> Establish and maintain a centipede or bermudagrass and evergreen shrub buffer strip along the road between the Force Troops Barracks and the maintenance area.	813
861363 S-36	1	<u>Stream Crossing New Force Troops Area.</u> Install a drop inlet structure and divert road water runoff into it.	275
856356 S-37	1	<u>Landing NE Side of Mouth of Frenchs Creek.</u> Construct a series of diversions. Establish and maintain fescue and sericea lespedeza.	804
856441 S-38	3	<u>Power Right-of-Way and Bare Area S of Nursery.</u> Build up the roadbed. Establish and maintain perennial grass in the right-of-way.	6,220
884432 S-39	3	<u>Utility Right-of-Way SW of Piney Green Rd. and NC 24 Intersection.</u> Establish and maintain a mixture of fescue sericea lespedeza in the right-of-way.	4,020

Grid Location & Site Number	Priority	Site Description and Planned Treatment	Cost Estimate
883426 S-40	1	<u>Borrow Area E of Magazine Area on Piney Green Rd.</u> Establish and maintain perennial grass.	\$ 776
873426 S-41	2	<u>Magazine Area Piney Green Rd.</u> Establish and maintain a mixture of sericea lespedeza and lovegrass on the mounds.	3,840
862380 S-42	1	<u>Open Area SE of Industrial Area.</u> Construct a series of diversions for surface water control. Establish and maintain perennial grass on the diversions. Plant pine seedlings in the disturbed area.	495
880355 S-43	1	<u>Magazine Area Sneads Ferry Rd.</u> Establish and maintain bahiagrass. Seed using a cultipacker seeder and take care not to disturb natural vegetation except where shaping is necessary to operate equipment. Install approximately 15 grade control structures in the drains to reduce the steep grade.	9,993
895342 S-44	1	<u>OP-5 Sneads Ferry Rd.</u> Establish and maintain a permanent ground cover on the side slopes by seeding weeping lovegrass or sprigging coastal bermudagrass.	270
882341 S-45	1	<u>Stream Crossing on Tributary S of Frenchs Creek.</u> Construct a diversion across the road at the entrance. Close the road to traffic, grade and shape the roadbed and drains. Establish and maintain perennial grass on the road area.	535
879338 S-46	1	<u>Borrow Area S of Main Magazine Area.</u> Close the old road, install a 12" perforated riser pipe and construct a berm across the old road to act as a sediment basin. Shape the borrow area and establish and maintain fescue vegetation.	1,460
877345 S-47	2	<u>Landing Frenchs Creek S of Main Magazine Area.</u> Divert the runoff from the main road into the woods where the road enters on the left. Grade the roadbed and establish and maintain perennial grass.	535
866349 S-48	2	<u>Road S Side of Frenchs Creek.</u> Close the road by installing a diversion at the top of the hill. Establish and maintain perennial grass on the closed section of road.	500
855350 S-49	1	<u>End of Road S of the Mouth of Frenchs Creek.</u> Close the main road on the right that goes to Frenchs Creek by installing a diversion above the gullied area on the left. Establish ground cover on the gullied areas by planting trumpet creeper and sericea lespedeza. Establish and maintain perennial grass on nearly level, less eroded areas.	785
857337 S-50	2	<u>Old Road Crossing on Duck Creek.</u> Establish and maintain perennial grass in the roadbed on both sides of the creek.	375
853383 S-51	2	<u>Parade Ground S of Heating Plant.</u> Install approximately 1,000 feet of drain tile to lower the water table.	900
842336 S-52	1	<u>Amphibious Landing Site E Side of New River.</u> Construct a concrete ramp 8 inches thick, 20 feet wide and 50 feet long for vehicle access at the river. Divert surface runoff into adjacent woods and seed the surrounding area.	1,496
825312 S-53	3	<u>Gully E Stream Bank of New River.</u> Plant the gully to an adapted vine and maintain to control erosion.	244

Grid Location & Site Number	Priority	Site Description and Planned Treatment	Cost Estimate
823312 S-54	2	<u>Gully E Stream Bank of New River N of NC 172 and Amphibious training area.</u> Close the road and grade so as to divert surface runoff away from the gully. Establish vegetation by planting trumpet creeper or honeysuckle on the steeper slopes. Establish and maintain an adapted grass on the less sloping areas.	\$ 344
836302 S-55	1	<u>Marine Road N of NC 172 Intersection.</u> Fill the gully on the east side of the road. Install an asphalt chute for removal of runoff down the slope to the stream.	290
835297 S-56	2	<u>Marines Road from Intersection of NC 172 N to the Stream.</u> Install an asphalt chute on the east side of the road.	240
802294 S-57	1	<u>Gullied Area E of Sneads Ferry Gate, New River.</u> Construct a diversion around the gully. Establish and maintain grass in the diversion and adjacent bare areas. Plant trumpet creeper in the gullied areas.	575
800303 S-58	2	<u>West Side of Sneads Creek.</u> Close the road and install a diversion at the top of the slope. Fertilize the natural vegetation on the slope below the diversion.	120
803302 S-59	1	<u>Open Area E Side of Sneads Creek.</u> Construct a diversion adjacent to the shore. Establish and maintain perennial grass.	1,075
801304 S-60	2	<u>Open Area E Side of Sneads Creek.</u> Establish perennial grass and plant in pine seedlings.	900
815293 S-61	2	<u>Amphibious Training Area Between Sneads Creek and Courthouse Bay.</u> Construct a diversion to divert surface runoff into the woods north of the gullied area. Establish and maintain perennial grass. Maintain a vegetative buffer zone around this entire area to trap sediment before it enters the river.	200
816303 S-62	1	<u>Entrance Amphibious Training Area off NC 172.</u> Install a sediment basin using eight inch perforated pipe riser. Establish and maintain vegetation on the embankment and remove sediment from the stream and culverts under NC 172.	927
825298 S-63 (a)	1	<u>Amphibian Troops Area.</u> Construct a seven foot high berm along the shoreline to restrict vehicle traffic entering the water. Establish and maintain bermudagrass on the berm. Install drop inlet structures for surface runoff removal. Construct a concrete ramp for vehicle access to the river.	2,975
825798 S-63 (b)	1	<u>Building 1A S Side.</u> Restrict vehicles off area. Pave the area over the sewer line. Reshape the road shoulders and surface runoff drains around the buildings. Establish and maintain adapted lawn grasses.	1,000
827299 S-64	1	<u>Eroding Shoreline near Monument, Courthouse Bay.</u> Construct a sediment basin using a twelve inch perforated riser in the structure. Establish and maintain perennial grass on the berm and in the adjacent area.	865
832297 S-65	1	<u>Stream Crossing on Tank Trail Between Courthouse Bay and Amphibian Troops Area.</u> Install four sediment basins using twelve inch perforated pipe risers in each structure. Basin is to be located on each side of the road and on each side of the stream. Establish and maintain perennial grass	1,615



Grid Location & Site Number	Priority	Site Description and Planned Treatment	Cost Estimate
832297 S-65	1	<u>Stream Crossing on Tank Trail Between Courthouse Bay and Amphibian Troops Area.</u> (continued) on the fill or berm areas.	
834282 S-66	3	<u>Open Area SE of Courthouse Bay.</u> Establish and maintain perennial grass in the bare area.	\$ 187
834287 S-67	1	<u>Courthouse Bay Area.</u> Install a sediment basin in the gully at the outlet end of the ditch. Construct the basin by placing a fill across the gullied area, finishing the fill to a minimum five foot top width and a 2:1 side slope. Install a twelve inch perforated pipe riser three feet below the top of the fill and allow sediment to collect in the gully. Establish and maintain perennial grass on the berm and in adjacent areas.	440
837287 S-68	1	<u>East Side, Courthouse Bay.</u> Slope the road side and reshape the drains. Establish and maintain adapted perennial grass. Mulch the steep slopes and install jute matting in the channel of the drains. Install twelve inch drop inlet structures where the water enters the stream. Construct a grass waterway from the east end of the parking lot behind Building BB-52 along the west boundary of the cleared area to the road drain. Establish and maintain a perennial grass in the waterway. Reconstruct the berm on the west side of the stream and install two twelve inch drop inlet structures. Establish and maintain perennial grass on the berm.	2,722
834290 S-69	2	<u>Gully on the Road Across from BB-50, Courthouse Bay.</u> Restrict equipment on the embankment and reestablish and maintain the area in bermudagrass. Repair the concrete lined channel outlet.	80
843285 S-70	3	<u>Utility Right of Way E of Engineering Training Area, Courthouse Bay.</u> Establish and maintain bahiagrass in the right-of-way.	1,800
849289 854288 S-71,72	2	<u>Tank Trail E of Courthouse Bay.</u> Install a 12 inch asphalt coated CMP culvert under the tank trail at the stream crossing at each site. Install the culvert with sufficient depth to have a minimum two feet of cover.	1,040
848280 S-73	3	<u>North Side of Traps Bay.</u> Install steps down the bank for access to the water. Install a picnic table and garbage disposal site for recreation facilities. Establish and maintain centipede grass.	298
852280 S-74	3	<u>Mouth of Traps Creek, W Side.</u> Install steps to provide access to the water, picnic and garbage disposal facilities. Establish and maintain centipede grass.	298
860287 S-75	1	<u>Tank Trail Parallel to NC 172, NE of Traps Bay.</u> Install a sediment basin by constructing a berm with dredged spoil between the tank trail and NC 172 east of the stream. Install a 12 inch perforated riser pipe in the basin. Install a sediment basin in the draw approximately 150' west of the stream crossing and south of the tank trail. Use a 12" perforated riser pipe. Construct two ramps across the trail to divert surface runoff into the sediment basins. The ramps should be five feet high, have an eight foot top width and six to one side slopes. A 12 inch CMP will be installed on the north end of the ramp east of the stream crossing to take water through the ramp. Use an asphalt chute to carry water from the pipe	4,832

Grid Location & Site Number	Priority	Site Description and Planned Treatment	Cost Estimate
860287 S-75	1	<u>Tank Trail Parallel to NC 172, NE of Traps Bay.</u> (continued) to the sediment basin. To establish vegetative cover, the side slopes of the trail crossing the stream and dikes for the sediment basins will be seeded to sericea lespedeza and fescue or bahia depending on the season and time of construction. Mulch the seeded slopes to control erosion.	
862287 S-76	1	<u>Borrow Area E of Tank Trail Crossing at Traps Creek.</u> Install an asphalt chute for outleting runoff into the stream east of the borrow area. Establish and maintain sericea lespedeza and fescue ground cover.	\$ 700
875253 877252 S-77,78	1	<u>Tank and Amphibious Vehicle Crossing, Inland Waterway S of TLZ Bluebird.</u> Construct a 50' x 20' x 8" concrete ramp for vehicle access to the water. Divert surface runoff into the adjacent woods. Establish and maintain perennial grass in the area disturbed by construction.	2,992
872257 S-79	2	<u>TLZ Bluebird.</u> Establish and maintain bahiagrass in the drain along the shoulder of the runway and in bare areas.	2,832
855308 S-80	1	<u>East of TLZ Albatross on Training Road.</u> Shape and grade the ditches draining into the stream. Establish and maintain bermuda or bahiagrass in the drains. Install jute matting in the channels at the time of seeding.	250
887333 S-81	1	<u>Borrow Area S of Marines Road.</u> Construct a sediment basin and install 12 inch perforated riser pipe in the basin on the lower end of the borrow area. Shape the adjoining area to provide surface drainage. Establish and maintain perennial grass. Plant the area to pine seedlings if natural seeding does not produce a suitable stand of trees.	1,070
885333 S-82	1	<u>Stream Crossing W of Borrow Pit, Marine Road.</u> Install a 42 inch CMP for crossing the stream. Reshape the roadbed and side drains. Establish and maintain bahiagrass or bermudagrass on the road berm and drains. Mulch area at the time of seeding.	700
882282 S-83	2	<u>Training Road E of Entrance to TLZ Bluebird and N of NC 172.</u> Install a 36 inch culvert for crossing the stream. Reshape the roadbed and side drains. Establish and maintain perennial grass in the drains and along the road shoulder.	700
892274 S-84	1	<u>Tank Trail Crossing Holover Creek.</u> Install a 42 inch culvert for crossing the stream. Deepen channel in the area to insure a three foot cover over the culvert. Build up the trail over the culvert so that surface water does not pond on the trail. Construct two earth ramps, 5 feet high with six to one side slope, to divert runoff from the sloping sections of road into the woods.	1,450
895263 S-85	3	<u>Open Area Inland Waterway S of TLZ Albatross.</u> Establish and maintain bahiagrass.	375
900266 S-86	1	<u>Tank Trail, Inland Waterway SE of TLZ Albatross.</u> Construct a 50' x 20' x 8" concrete ramp to provide access for amphibious vehicles and tanks to the water. Divert runoff from the trail into adjacent wooded areas. Establish and maintain the areas around the ramp in bahiagrass.	1,496

Grid Location & Site Number	Priority	Site Description and Planned Treatment	Cost Estimate
895272 S-87	3	<u>TLZ Albatross.</u> Grade the area to provide surface drainage as needed. Establish and maintain bahiagrass.	\$3,750
905281 S-88	3	<u>Training Area W of Mockup Road.</u> Establish and maintain bahiagrass.	375
912269 S-89	1	<u>Beach Area Around the Rental Units on the Frontal Sand Dunes.</u> Stabilize the sand dunes with American beachgrass. Plantings will be done in accordance with the specifications for stabilizing critical areas contained in the appendix. These areas maybe established in adapted lawn grasses and landscaped with shrubbery. This would increase the cost of treatment. If such treatment is planned, refer to the publications <u>Sea Coast Plants of the Carolina's</u> for adopted shrubs and lawn grasses.	2,741
901264 S-90	1	<u>Tank and Amphibious Vehicle Trail on Beach Side of Inland Waterway.</u> Construct a concrete ramp 50' x 20' x 8" to provide vehicle access to the water. Divert runoff to adjacent vegetated areas and establish and maintain vegetative cover on the area disturbed by construction.	1,496
902262 S-91	1	<u>Beach Area S of the Bridge.</u> Stabilize the frontal sand dunes by planting American beachgrass. Planting will be done in accordance with the specification for stabilizing critical areas contained in the appendix.	1,150
914283 S-92	3	<u>Open Area N of Beach Bridge.</u> Establish and maintain bahiagrass.	190
920283 S-93	3	<u>Open Area on the Inland Waterway NE of Beach Bridge.</u> Establish and maintain bahiagrass.	50
919308 S-94	3	<u>TLZ Goose.</u> Grade the area where needed to provide surface drainage. Establish and maintain bahiagrass.	5,650
942321 S-95	2	<u>G-5 Range.</u> Install steps on the berm where the gully is located.	250
950325 S-96	3	<u>Utility Right-of-Way E of G-5 Range.</u> Establish and maintain fescue and clover.	3,940
965340 S-97	3	<u>Utility Right-of-Way E of G-5 Range from NC 172 to Brown's Tower.</u> Establish and maintain fescue and clover.	3,830
956348 S-98	2	<u>Stream crossing E of NC 172 and N of G-7 Range.</u> Install a 30 inch culvert under the road. Deepen channel in the area to insure a two feet cover of fill. Divert runoff into the woods before it reaches the stream.	550
955351 S-99	1	<u>Tank Trail Crossing at Spring Branch.</u> Relocate the entrance to the Bear Creek Tower Road to the top of the hill. Close the old road. Remove the loose joints of culvert and install sand-cement bag headwall at NC 172. Construct a ramp across the tank trail on the south side of the stream to divert runoff into the woods. Establish and maintain perennial grass on the bare areas and side slopes when construction is completed.	1,890
961367 S-100	1	<u>Training Road E of Triangle Outpost.</u> Construct a diversion along the east side of the main road across the ridge. Fill gully, shape and establish and maintain perennial grass in the diversion and filled area.	230

Grid Location & Site Number	Priority	Site Description and Planned Treatment	Cost Estimate
958364 S-101	1	<u>Driver Training Area SE of Triangle Outpost.</u> Close the old roads and fill the gullies. Establish and maintain bahiagrass. Construct new trails on the contour and restrict unnecessary vehicle traffic up and down the hills.	\$ 1,925
940423 S-102	2	<u>Stream Crossing South of the Hubert Fire Tower.</u> Install a 24 inch culvert in the stream and under the road covered with at least two feet of fill. Install a grade control structure to break the grade in the side drain. Establish and maintain perennial grass. Install jute matting in the drains at time of seeding.	504
948387 S-103	3	<u>TLZ Lark.</u> Shape the area to eliminate the large poorly drained holes. Establish and maintain bahiagrass.	10,700
946386 S-104	1	<u>Woods Road W of TLZ Lark.</u> Close the west fork of the road. Fill the gully.	268
944384 S-105	1	<u>Road from TLZ Lark to Lyman Road.</u> Reshape the road drains from the hill tops to the stream. Fill the gullies. Establish and maintain bahiagrass in the drains. Install jute matting in the channel bottom at the time of seeding. Do not disturb established vegetation on the steep road banks south of the stream crossing.	2,150
948362 S-106	1	<u>Stream Crossing on the Dirt Road E of G-10 Impact Area.</u> Install a 24 inch culvert under the road covered by at least two feet of fill. Shape the roadbed. Establish and maintain bahiagrass.	469
920313 S-107	1	<u>Borrow Area Across NC 172 from TLZ Goose.</u> Establish and maintain fescue - clover in the borrow area and on road shoulders on both sides of the stream.	563
921316 S-108	1	<u>Stream Crossing N of TLZ Goose.</u> Install a 12 inch culvert under the road. Use a backhoe to construct an open ditch for carrying runoff into the drain east of the road. Establish and maintain bahiagrass.	336
922314 S-109	1	<u>Stream Crossing N of TLZ Goose.</u> Install a 24 inch culvert under the road covered by at least two feet of fill. Construct sand-cement bag headwalls at each end of the culvert. Establish and maintain bahiagrass.	692
917821 S-110	1	<u>Old Road Between NC 172 and Engineer Stockade.</u> Grade roadbed. Establish and maintain bahiagrass.	1,015
908318 S-111	3	<u>Old Road System SW of Engineer Stockade.</u> Establish and maintain bahiagrass on the old roadbed.	1,762
905314 S-112	2	<u>North of Sneads Ferry Road and NC 172.</u> Plant and maintain Virginia creeper or trumpet creeper on the mound and surrounding areas.	508
903374 902374 S-113 S-114	3	<u>G-8 and G-9 Ranges.</u> Reestablish vegetation on the firing mounds by seeding and maintaining bahiagrass.	228
900375 S-115	3	<u>TLZ Penguin.</u> Establish and maintain bahiagrass.	5,680
937376 S-116	1	<u>F-3 Range.</u> Stabilize the bare, eroding mounds and open area maintaining bahiagrass. Mulch steep slopes at time of seeding.	5,400

Grid Location & Site Number	Priority	Site Description and Planned Treatment	Cost Estimate
942379 S-117	2	<u>Road Bank of F-3 Range.</u> Plant honeysuckle along the bank.	\$ 508
937375 S-118	2	<u>Entrance to F-3 Range.</u> Stabilize eroding bank by establishing and maintaining perennial grass.	134
940374 S-119	2	<u>Borrow Area S of Lyman Road and F-3 Range.</u> At time borrow removal is complete, grade area to provide surface drainage. Establish and maintain fescue and clover.	535
915374 S-120	2	<u>Observation Post 2.</u> Establish and maintain sericea lespedeza and lovegrass on the front and sides of the mound.	270
915375 S-121	2	<u>Open Area Across Lyman Road from OP-2.</u> Establish and maintain bahiagrass.	1,125
909407 S-122	1	<u>Road Bank S of F-5 Range.</u> Stabilize eroding area on the south side of the curve by establishing and maintaining bahiagrass. Grade the road drains from the crest of the hill to the stream. Establish and maintain bahiagrass in the road drains and road along the shoulders. Mulch entire area at time of seeding and install jute matting in the channel of the drains.	365
912419 S-123	2	<u>Stream Crossing Between F-4 and F-5 Range.</u> Install a 12 inch culvert under the road covered by at least two feet of fill. Use a dragline or backhoe to deepen area sufficient to obtain the necessary depth for the culvert.	116
912423 S-124	2	<u>Stream Crossing Between F-4 and F-5 Range.</u> Install a 42 inch culvert with a minimum of two feet of fill over the culvert. Install sand-cement bag headwalls.	420
918425 S-125	3	<u>Utility Right-of-Way from NC 24 to F-4 Range.</u> Establish and maintain sericea and fescue in the right-of-way.	1,015
917421 S-126	2	<u>F-4 Range.</u> Establish and maintain bahiagrass in the bare area at the entrance to the range.	75
857429 S-127	1	<u>Holcomb Blvd. W of Old Sawmill Site.</u> Extend existing culvert into the woods and fill the gullied area. Install a catch basin for runoff to enter the pipe adjacent to the road. Grade the area so that runoff enters the catch basin and does not wash over the end of the fill material. Establish and maintain annual ryegrass and centipede on the filled area.	544
857426 S-128	1	<u>Holcomb Blvd. W of Old Mill Site.</u> Extend existing pipe outlet into the woods. Fill the gully and install a catch basin to allow runoff water to enter the pipe. Divert runoff into the catch basin. Establish and maintain centipede and annual ryegrass on the fill.	385
785278 S-129	2	<u>Mouth of Everett Creek.</u> Stabilize eroding area by establishing and maintaining fescue and clover ground cover.	222
773283 S-130	2	<u>Stream Crossing on Road N of Everett Creek.</u> Install a 12 inch culvert under the road covered by two feet of fill. Construct an open ditch to provide an outlet for runoff.	141
766279 S-131	1	<u>Road to Everett Creek.</u> Divert runoff from the top of the hill into the woods on the east side of the road. Establish and maintain fescue and clover on the road and in open area near the creek.	213

Grid Location & Site Number	Priority	Site Description and Planned Treatment	Cost Estimate
768284 767284 S-132 S-133	2	<u>Stream Crossing on Road N of Everett Creek.</u> Install a 12 inch culvert under the road covered by at least two feet of fill. Reshape the road side drains. Establish and maintain bahiagrass.	\$ 292
768286 S-134	3	<u>Road to Chemical Disposal Area.</u> Establish and maintain bahiagrass on old roadbed.	750
763286 S-135	1	<u>Open Area North of Old Viet Cong Village.</u> Construct two diversions. Establish and maintain fescue and clover.	850
764283 S-136	1	<u>Utility Right-of-Way from Intersection of US 17 and Dixon Road to Mouth of Everett Creek.</u> Divert runoff into adjacent woods where the right-of-way intersects streams and erosion has caused siltation. Establish and maintain bahiagrass in the right-of-way.	1,399
753300 S-137	3	<u>Recreation Area SW Corner of Rifle Range.</u> Grade and smooth area. Establish and maintain adapted perennial grasses.	2,100
747308 S-138	1	<u>Recreation Area on Stones Creek W of Rifle Range.</u> Construct a diversion across the top of the bank and install twelve inch outlet pipes at each end. Establish vegetative cover by sprigging St. Augustine on the front slope of the bank and the diversion. Maintain grass. Construct a concrete ramp from top of the slope to water's edge for launching boats.	1,350
763305 S-139	2	<u>Road to New River E Side of Rifle Range.</u> Shape the road and fill the gullies. Surface the road with Marl. Establish and maintain fescue in the side drains and along the road berms. Mulch the drain channels at the time of seeding.	1,335
764302 S-140	1	<u>Cleared Area E of Stockade at the Rifle Range.</u> Construct two diversions. Establish and maintain perennial grass.	261
759297 S-141	1	<u>Rifle Range Beside Building RR200.</u> Line the open ditch with asphalt to prevent erosion.	1,200
756297 S-142	2	<u>Open Area at the Rifle Range SW of Stone Bay Camp.</u> Divert surface runoff into the woods. Establish and maintain perennial grass.	830
753302 S-143	1	<u>Gully, W Side of Rifle Range.</u> Install a concrete lined stilling basin at pipe outlet. Extend the pipe outlet and fill the gully. Establish and maintain vegetation on area.	1,296
737304 S-144	2	<u>Road to L-5 Range from Dixon Road.</u> Divert surface runoff from the road area into the woods. Grade the road and reshape the drains. Establish and maintain bahiagrass in the road drains and on the shoulders. Install jute matting in the channel drains.	176
735302 S-145	2	<u>Dirt Road from Dixon Road to L-5 Range.</u> Divert surface runoff from the woods. Reshape the side drains. Establish and maintain bahiagrass.	130
737308 S-146	2	<u>Utility Right-of-Way to L-5 Range.</u> Establish and maintain sericea lespedeza - bahiagrass.	2,443

Grid Location & Site Number	Priority	Site Description and Planned Treatment	Cost Estimate
732323 S-147	1	<u>NW of L-5 Range on the Dirt Road.</u> Construct an open ditch for road drainage. Establish and maintain bahia-grass in the roadbed.	\$ 380
730324 S-148	2	<u>Training Road Intersection E of Dixon Fire Tower.</u> Fill the holes and grade the road at the intersection so that surface runoff will drain to the natural drain in the woods south of the intersection.	160
727313 S-149	2	<u>Training Road SE of Dixon Fire Tower.</u> Construct an open ditch for road drainage and install a 12 inch culvert at the road crossing. Install the culvert at a depth that will assure two or more feet of fill cover.	181
728326 S-150	2	<u>Training Road NE of Dixon Fire Tower.</u> Install a 12 inch culvert where the stream crosses the road. Install the culvert at a depth that will assure two feet of fill cover.	75
732330 S-151	1	<u>Training Road N of Dixon Fire Tower.</u> Shape the eroded bank on the east side of road. Establish and maintain bahiagrass. Mulch area at the time of seeding.	148
733333 S-152	1	<u>Training Road NE of Dixon Fire Tower.</u> Install asphalt lining in the road drains on the steeper grade. Install pipe or asphalt chute to outlet the runoff into the creek.	905
738339 S-153	1	<u>Training Road S of Verona Loop.</u> Construct sand-concrete bag headwalls at the culvert in the stream crossing. Establish and maintain bahiagrass on the road shoulders and in the drains around the culvert. Mulch slopes at time of seeding.	277
740349 S-154	2	<u>Training Road S of Verona Loop.</u> Construct open ditch to divert surface runoff from the woods to the culvert under the road.	270
775346 S-155	1	<u>Mill Creek Road.</u> Reshape the road drains to facilitate mowing. Establish and maintain bahiagrass in the drains. Install jute matting in the channel of the drains. Install drop inlet structures for the drains at the culvert inlets. Remove sediment from the natural drains at the culverts and install sand-concrete bag headwalls.	9,745
775348 S-156	2	<u>Range on Mill Creek Road - K-402.</u> Establish and maintain bahiagrass on the eroding area at the entrance of the range.	113
775344 S-157	2	<u>Range on Mill Creek Road - K-406.</u> Establish and maintain bahiagrass on the bare area.	412
774338 S-158	1	<u>End of Mill Creek Road.</u> Install a drop inlet structure using a 10 foot section of 12 inch pipe. Divert surface runoff from the turn around area into the drop inlet structure. Establish and maintain bahiagrass on the diversion.	143
780352 S-159	2	<u>Range on Verona Loop Road - K-212.</u> Establish and maintain bahiagrass on the area around the tower.	167
793359 S-160	2	<u>Drain from Mess Shelters and Classrooms, Rhodes Point Road.</u> Establish and maintain adapted perennial grass in the surface drains.	53
793358 S-161	1	<u>The Rhodes Point Road.</u> Establish and maintain fescue on eroded bank. Mulch the bank at time of seeding.	53

Grid Location & Site Number	Priority	Site Description and Planned Treatment	Cost Estimate
796358 S-162 802360 S-163	1	<u>Rhodes Point Road.</u> Reshape the road drains to facilitate mowing. Establish and maintain perennial grass. Mulch the channel of the drains with jute matting at the time of seeding.	\$5,920
819357 S-164	1	<u>Stream Crossing on Rhodes Point Road.</u> Install sand-concrete bag headwalls at the culvert. Install drop inlet structures to inlet road water into the stream. Use four 12 inch pipes for the structure.	216
823354 S-165	2	<u>Bare Area N of Rhodes Point Road.</u> Establish and maintain bahiagrass.	222
827353 S-166	1	<u>End of Rhodes Point Road.</u> Construct a concrete ramp to provide vehicles access to the water. Construct a diversion to protect gullied area and outlet runoff into the river through 18" drop inlet structure. Fill the gullies at the end of the road. Establish and maintain bahiagrass in this area and on the diversion. Install jute matting in the channels following grading.	5,873
795369 S-167 797368 S-168	1	<u>Road N of Rhodes Point Road.</u> Install a 12 inch culvert under the road where the natural drain crosses. Deepen the drain so that the depth of the culvert will be sufficient to insure at least two feet of fill over the pipe. Install sand-cement bag headwalls.	452
802364 S-169	1	<u>Stream Crossing N of Intersection, Rhodes Point Road and Training Road.</u> Remove sediment from the stream to restore its natural depth. Install a new culvert in line with the channel flow. Install sand-cement bag headwalls at the culvert. Reshape the side drains on each road side from the culvert to the top of the hill. Establish and maintain perennial grass in the drains. Install jute matting in the drains following shaping.	893
802363 S-170	1	<u>Borrow Area N of Rhodes Point Road.</u> Fill the gullied area at the end of the borrow area. Establish and maintain bahiagrass. Mulch the sloping area to prevent erosion.	68
795372 S-171	1	<u>Stream Crossing on Town Point Road.</u> Excavate a channel in the old drain and install a 12 inch culvert under the road. Install a culvert so that it has at least two feet of fill covering. Use sand-cement bag headwalls on each side of the culvert.	181
796374 S-172	1	<u>Stream Crossing, Dirt Road Between Town Point Road and Rhodes Point Road.</u> Construct an open ditch to intersect the main drain south of the road. Install a 12 inch culvert with at least two feet of fill covering. Install sand-cement bag headwalls on both ends of the culvert.	181
801377 S-173	1	<u>Stream Crossing Road Between Town Point and Rhodes Point Roads.</u> Clean out the natural drain and restore capacity. Install a twelve inch culvert under the road with sand-cement bag headwalls. Install the culvert at a depth that assure at least two feet of fill cover.	346
816382 S-174	1	<u>Town Point Road Just N of the Point.</u> Fill the low area in the road. Install rock rip-rap at the toe of the bank to a height of three feet. Plant the remaining bank area to honeysuckle and maintain.	458



Grid Location & Site Number	Priority	Site Description and Planned Treatment	Cost Estimate
817380 S-175	1	<u>Town Point.</u> Install a concrete ramp to provide for vehicle access to the water. Extend the ramp from water-sedge to the top of the slope. Place rock rip-rap on the northern exposure to a height of three feet. Plant the bank above the rip-rap to honeysuckle and maintain. Establish and maintain bahiagrass on the gullied area around the monument.	\$6,053
803385 S-176	1	<u>End of Town Point Road.</u> Construct a diversion from the road bank where the gullies begin on the north side to the south side of the road. Place a 12 inch culvert through the bank on the south side of the road. Establish and maintain fescue and sericea lespedeza. Install jute matting in the channels at the diversion following construction.	564
795382 S-177	1	<u>Town Point Road About Half Way to the River.</u> Reshape the road drains, finishing slopes so that they can be easily mowed and maintained. Install jute matting in the drains. Establish and maintain adapted perennial grasses.	1,458
781379 S-178	1	<u>Stream Crossing on Town Point Road.</u> Start in the down stream area and remove the silt to restore the channel's capacity. Install a thirty inch culvert under the road with at least two feet of fill cover. Construct sand-cement bag headwalls at the ends of the culvert. Reshape the road drains. Finish drain slopes so that they can be mowed. Install jute matting in the channels of the drains. Establish and maintain fescue. Install 12" drop inlet structures at the end of the road drains.	4,414
772378 S-179	1	<u>Stream Crossing Near Entrance of Town Point Road.</u> Start in the down stream area and excavate a channel to the road deep enough to install a 24 inch culvert with at least two feet of fill covering. Construct sand-cement bag headwalls at the culvert ends. Reshape the road drains to facilitate mowing. Establish fescue and maintain. Install jute matting in the drains. Install twelve inch drop inlet structures in the ends of the drains. Establish and maintain bahiagrass on the bare road bank and open area south of the road.	4,535
790387 S-180	1	<u>Road Crossing on Lewis Creek.</u> Replace culvert under the road and install sand-cement bag headwalls. Reshape the roadbed and side drains. In these areas establish and maintain bahiagrass. Install jute matting in the channels of the drains. Divert the runoff into the woods at the top of the hill on each side of the drain.	4,100
783387 S-181 782386 S-182	2	<u>Woods Road Between Town Point and Ragged Point Roads.</u> Construct an open ditch intersecting the natural drains adjacent to the road. Install a 12 inch culvert with a minimum cover of two feet of fill. Install sand-cement bag headwalls at the culverts.	313
779386 S-183	2	<u>Woods Road Between Town Point and Ragged Point Roads.</u> Fill the holes in the road and grade the roadbed so that runoff is outleted into the woods.	700
787421 S-184	1	<u>End of Ragged Point Road.</u> Construct a diversion across the road above the gullies. Install an asphalt chute and a 12 inch drop inlet structure. Establish and maintain sericea lespedeza and fescue on the diversion and gullies. Install jute matting in the diversion channels.	385

Grid Location & Site Number	Priority	Site Description and Planned Treatment	Cost Estimate
770386 S-185 767384 S-186	2	<u>Ragged Point Road.</u> Construct an open ditch from the natural drain on the north to the road. Install a 12 inch culvert covered with a minimum of two feet of fill. Install sand-cement bag headwalls at the ends of the culvert.	\$1,036
742388 S-187	2	<u>Road S of First Intersection, Verona Loop.</u> Construct an open ditch for drainage. Install a 24 inch culvert with sand-cement bag headwall. Install culvert at a depth sufficient to have a minimum of two feet of fill over the culvert.	740
758369 S-188	2	<u>Second Road to the Right, Verona Loop, S of Ammo Supply Point.</u> Construct an open ditch along the road and in the natural drain north east of the area. Install a 12 inch culvert with sand-cement bag headwalls where water crosses the road. Install culvert with depth sufficient to have a minimum of two feet of fill over the culvert.	292
757366 S-189	2	<u>Road Intersection S of Ammo Supply Point, Verona Loop Road.</u> Construct an open ditch for drainage to the natural drain south of the intersection. Install a 12 inch culvert with sand-cement bag headwalls. Install a culvert with minimum of two feet of fill over the culvert.	292
749376 S-190	1	<u>Stream Crossing S of Entrance to the Verona Loop Road on First Road to the Right.</u> Grade the roadbed and reshape side drains from the top of the hills to the culvert. Establish and maintain bahiagrass on the roadbed and in the drains. Install sand-cement bag headwalls at culvert with drop inlet structures for road runoff to outlet into stream.	1,084
751366 S-191	1	<u>Stream Crossing on the Dirt Road SE of Gate to Verona Loop.</u> Reshape the road drains to facilitate mowing. Establish and maintain perennial grass in the drains. Install a drop inlet structure at the end of the drains to outlet runoff into the creek. Install sand-cement bag headwalls at the culvert.	1,265
768368 S-192	1	<u>Stream Crossing on the Dirt Road S of Intersection, Town Point and Verona Loop Roads.</u> Install sand-cement bag headwalls and drop inlet structures for the road drains at the culvert. Reshape the road drains from the top of the slope to the culvert to facilitate mowing.	861
766400 S-193	1	<u>Maple Landing on Southwest Creek.</u> Reshape the road drains coming down the hill and outlet drains into the woods where-ever possible. Install jute matting in the channel of the drains. Establish and maintain bahiagrass. Surface the road with marl from the landing area to the top of the hill.	1,764
765395 S-194	2	<u>Maple Landing Road.</u> Install an asphalt chute on the slope, east side of the road. Install a 12 inch culvert under the road to outlet into the asphalt chute. Reshape the road drains and establish them in bahiagrass. Install jute matting in the channels of the drains.	281
745402 S-195 744404 S-196	1	<u>East of Intersection, Seaboard Coastline Railroad and US 17 at Verona.</u> Install an 18 inch culvert under the road at the break of the steep slope. Install an asphalt chute to carry water from the culvert outlet down the steep grade to the stream. Divert all the runoff above the culvert through the culvert or down the asphalt chute. Line the diversion on the upper side of the road with asphalt or rock rip-rap.	1,134

Grid Location & Site Number	Priority	Site Description and Planned Treatment	Cost Estimate
745403 S-197	1	<u>Stream Crossing E of Verona.</u> Grade the roadbed and re-shape the drains from the culverts at the break of the hill to the outlet at the stream. Install jute matting in the channel of the drains. Establish and maintain perennial grass.	\$1,278
757409 S-198	1	<u>East end of Race Course Area.</u> Construct a berm in a crescent shape around the explosive area. Install a 12 inch perforated pipe riser through the berm. Establish perennial grass in the area behind the wall.	580
738407 S-199	1	<u>North of Verona on the Seaboard Coastline Railroad.</u> Shape the road and remove silt from the drains and culverts. Establish and maintain perennial grass.	275
735411 S-200	1	<u>Borrow Area N of Verona.</u> Establish and maintain fescue and sericea lespedeza.	113
731414 S-201	2	<u>Natural Drain Crossing the Road N of Verona.</u> Construct an open ditch. Install a 12 inch culvert under the road covered by at least two feet of fill. Install sand-cement bag headwalls.	186
732428 S-202	3	<u>Old Borrow Pit S of Southwest Creek.</u> Reforest the borrow area. Leave an undisturbed buffer zone fifty feet wide along the creek. Install a trash collection container for people using the area for recreation.	50
741431 S-203	1	<u>Boat Access Area on Southwest Creek.</u> Divert surface runoff from the boat access area. Surface the last 150' of the road with marl. Install a trash collection container on the site at the ramp.	280
734441 S-204	1	<u>Old Dump Site at Geiger.</u> Establish and maintain perennial grass on the east side of the road adjacent to the stream.	38
739439 S-205	2	<u>Old Borrow Site E of Geiger Dump.</u> Shape the area so that surface runoff water will outlet into the adjacent woods. Finish side slopes to a three to one. Establish and maintain sericea lespedeza and fescue.	575
745437 S-206 746436 S-207	2	<u>Woodland Road S of the Air Station Barracks.</u> Clean out the natural drain that crosses the road. Install a 12 inch culvert with sand-cement bag headwalls. Culvert should be installed so as to have at least two feet of fill over the culvert.	372
750439 S-208	3	<u>Air Station Barracks Area.</u> Install approximately 800 ft. of concrete walkway.	1,800
753435 S-209	3	<u>Southwest Side of the Air Station Hangers.</u> Install a concrete walkway in front of the building across from the hanger. Install a bridge to cross the drainage ditch in front of the building.	513
755425 S-210	3	<u>The End of Runway Number 5 at the Air Station.</u> Establish and maintain sericea lespedeza and fescue.	5,650
761426 S-211	2	<u>Borrow Area Behind the Pond, Air Station.</u> Establish and maintain fescue and sericea lespedeza in the bare area.	150

Grid Location & Site Number	Priority	Site Description and Planned Treatment	Cost Estimate
765433 S-212	1	<u>The Runway Complex, Air Station.</u> Reestablish the bare, eroding areas to bahiagrass. Fertilize and maintain the entire area, mowing as needed to control weeds and to keep the area looking neat.	\$3,750
768415 S-213	3	<u>Cleared Area, End of Runway 36.</u> Establish and maintain sericea lespedeza and fescue in the cleared areas.	5,650
766412 S-214	1	<u>Boat Landing S of Runways, Southwest Creek.</u> Surface the sloping area at the landing site with marl. Establish and maintain fescue in the adjacent area. Install a trash container.	280
775419 S-215	1	<u>Marina Areas, Air Station.</u> Install an asphalt chute to outlet runoff from the parking area to the river.	250
774423 S-216	1	<u>Recreation Area S of Officers Quarters, Air Station.</u> Establish and maintain bahiagrass on the sloping area. Mulch the area at the time of seeding.	213
775423 S-217	1	<u>Basketball Court Behind Officers Quarters, Air Station.</u> Establish a sod on the steep slopes by seeding a mixture of annual rye and bahiagrass. Mulch the area at the time of seeding. Maintain vegetation when established.	339
755447 S-218	1	<u>South of Main Gate, Air Station.</u> Reshape the drain to facilitate mowing. Establish and maintain perennial grass in the drains. Install an asphalt chute to outlet surface runoff into the ditch.	238
756454 S-219	2	<u>North of Main Gate, Air Station.</u> Grade the bare area, finishing to provide a drain in the center for runoff removal. Establish and maintain perennial grass.	225
756456 S-220	1	<u>Culvert Under the Road N of Air Station's Main Gate.</u> Fill and shape the road berms to divert runoff from the slope. Establish and maintain fescue. Restrict traffic on the slope.	100
771461 S-221	1	<u>Training Point on New River, S of Jacksonville.</u> Construct a concrete ramp 50' x 20' x 8" to provide vehicle access to the water. Divert runoff from the parking area into the woods before it enters the river.	1,496
765460 S-222	1	<u>Culvert Under the Road N of Air Station.</u> Install sand-cement bag headwalls at the culvert.	70
765462 S-223	2	<u>Mouth of Brinson Creek.</u> Establish and maintain bahiagrass in the area around the old building.	113
761459 S-224	1	<u>Borrow Area E of Camp Geiger.</u> Shape the borrow area to permit surface water drainage. Establish and maintain bahiagrass.	223
759463 S-225	1	<u>Training Area, NE Side of Camp Geiger.</u> Grade and shape the area to permit surface water drainage. Establish bahiagrass. Mulch the slopes at the time of seeding. Mow and fertilize the area on a regular schedule for proper maintenance.	460
757463 S-226	1	<u>Camp Geiger, "G" Street Between Buildings 569 and 572.</u> Construct a berm along the open ditch to divert runoff from the side slopes. Install asphalt chutes in the low areas to outlet runoff. Establish and maintain the berm and surrounding area in perennial grass.	612

Grid Location & Site Number	Priority	Site Description and Planned Treatment	Cost Estimate
766456 S-227	2	<u>Camp Geiger, Parking Area on E Side Behind Building 864.</u> Shape the surface drain. Establish and maintain perennial grass. Mow vegetation in the drain and apply fertilizer annually.	\$ 45
755469 S-228	2	<u>Borrow Area N Side of Camp Geiger.</u> Grade borrow area to provide proper surface water drainage. Establish and maintain perennial grass.	375
743461 S-229	1	<u>South of Main Gate, Camp Geiger.</u> Construct an open ditch for drainage of the area. Install a 12 inch culvert under the road with sand-cement bag headwalls. Grade the roadbed to provide adequate drainage. Shape the road drains so that they can be mowed and will outlet into the open ditch. Establish perennial grass in the drains and maintain the vegetation as part of the grounds. Install jute matting in the channel of the drains at the time of seeding.	1,605
771436 S-230	1	<u>East of Runways, Air Station.</u> Clean out the drain from the river to the runways. Slope the side on the west side of the road to facilitate mowing. Use the spoil on the east side of the road to construct a maintenance road. Establish and maintain carpetgrass. Mulch the slopes to control erosion during establishment.	2,280
817363 S-231	1	<u>Explosive Ordnance Disposal Area N of Rhodes Point Road.</u> Construct a diversion along the river edge. Install two 12 inch drop inlet structures at the ends of the diversion to outlet runoff into the river. Establish and maintain bahiagrass on the diversion. Install jute matting in the diversion channel following construction.	476
S-232	1	<u>Marine Corps Helicopter Outlying Landing Field, NW Side.</u> Construct a berm along the river headwall. Install an 18 inch drop inlet structure to provide an outlet for surface runoff. Line the drains along the road edges down to the boat ramp area with asphalt. Divert runoff into the asphalt drains wherever possible. Construct a diversion on the north side of the shelter along the top of the bank and install asphalt chutes to outlet runoff into the roadside drains. Establish and maintain centipede and ryegrass in the area. Seeding rate of rye should be only sufficient to provide interim covering of all sloping areas at the time of seeding. Construct a concrete boat ramp to provide boat access to the water.	2,512
864373 S-233	1	<u>The 1800 Area Adjacent to Cogdels Creek.</u> Construct a berm along the creek and its tributaries in the built up areas west of Cogdels Creek. Establish common bermuda on the berm. Design and construct the berm with a top width and side slopes that will facilitate mowing. Install nine drop inlet structures to outlet runoff from the buildings and parking areas into the stream. Restrict traffic and repair any damage to the berm. Construct a grass waterway from the parking area behind building 1750 to the drop inlet structure above the heavy equipment stream crossing. Establish adapted perennial grasses in the waterway. Mulch waterway at the time of seeding. Fill the large gulley adjacent to the stream crossing behind building 1832. Restrict heavy equipment from crossing the curbing just north of the stream crossing and repair the curbing. Construct a series of diversions behind building 1842, east of building 1833. Outlet the diversions into	59,134

Grid Location & Site Number	Priority	Site Description and Planned Treatment	Cost Estimate
864373 S-233	1	(continued) two asphalt lined drains along the roadside leading to the gun park area. Construct dikes on both sides of Cogdels Creek in the gun park area. The length of the dike will be approximately 6,800 feet and have an eight foot top width and 3 to 1 side slopes. Use 6 to 1 side slopes in areas where vehicles will cross the dike. Establish perennial grass on the dike. Restrict vehicle traffic on the dike to planned crossings. Install 12 inch perforated rise pipes through the dike in low areas to act as sediment basins. Remove sediment from the basins as required to assure proper function.	\$59,134

I.

SCHEDULE OF SPECIAL TREATMENT AREAS BY SITE NUMBERS

- 1975 - 7, 9, 21, 28, 34, 36, 43, 52, 55, 63a, 3, 8, 23, 17a, 17b, 27, 29, 31, 32, 37, 40, 42  
44.
- 1976 - 67, 68, 75, 89, 99, 166, 169, 174, 175, 176, 45, 46, 49, 57, 59, 62, 64, 76, 80, 81  
82, 84, 86, 100.
- 1977 - 16, 18, 65, 77, 78, 179, 190, 198, 232, 233, 90, 91, 101, 104, 105, 106, 107, 108  
109, 110, 112, 117, 118.
- 1978 - 116, 122, 127, 128, 131, 135, 136, 138, 140, 141, 143, 147, 151, 152, 153, 155, 158  
161, 162, 163, 164, 167, 168, 170.
- 1979 - 171, 172, 173, 177, 180, 184, 191, 192, 193, 195, 196, 197, 199, 200, 203, 204, 212  
214, 215, 216, 217, 218, 220, 221.
- 1980 - 222, 224, 225, 226, 229, 230, 231, 2, 4, 6, 10, 11, 12, 14, 15, 19, 22, 24, 25, 26  
30, 35.
- 1981 - 41, 47, 48, 50, 51, 54, 56, 58, 60, 61, 63b, 69, 71, 72, 79, 83, 95, 98, 102, 112  
117, 118, 119.
- 1982 - 120, 121, 123, 124, 126, 129, 130, 132, 133, 139, 142, 144, 145, 146, 148, 149, 150  
154, 156, 157, 159, 160, 165.
- 1983 - 181, 182, 183, 185, 186, 187, 188, 189, 194, 201, 205, 206, 207, 211, 219, 223, 227  
228, 1, 5, 20, 23, 33, 38, 39.
- 1984 - 53, 66, 70, 73, 74, 85, 87, 88, 92, 93, 94, 96, 97, 103, 111, 113, 114, 115, 125, 134  
137, 202, 208, 209, 210, 213.



NATURAL RESOURCE MANAGEMENT PLAN MAP LEGEND

- S-100 Special Treatment Site
- S-102 Special Treatment Area
- D- Dike
- Wildlife Unit Boundary
- Wildlife Openings
- WL Wildlife Food Plots
- Small Game Strips
- Roads Planted for Wildlife
- Roads To Be Planted

- LEGEND
- Divided Highway
  - Good Motor Road
  - Poor Motor Road
  - Railroad
  - Project Boundary
  - County Line
  - Power Line
  - Forest Fire Lookout Station
  - Cemetery
  - School
  - Groins
  - Borrow Pit
  - Drainage
  - Pond or Lake

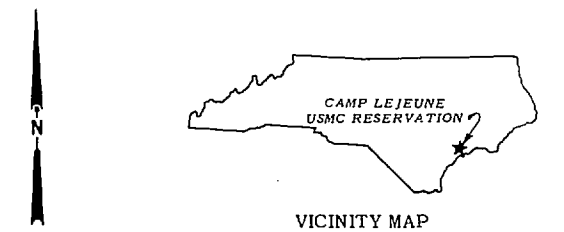
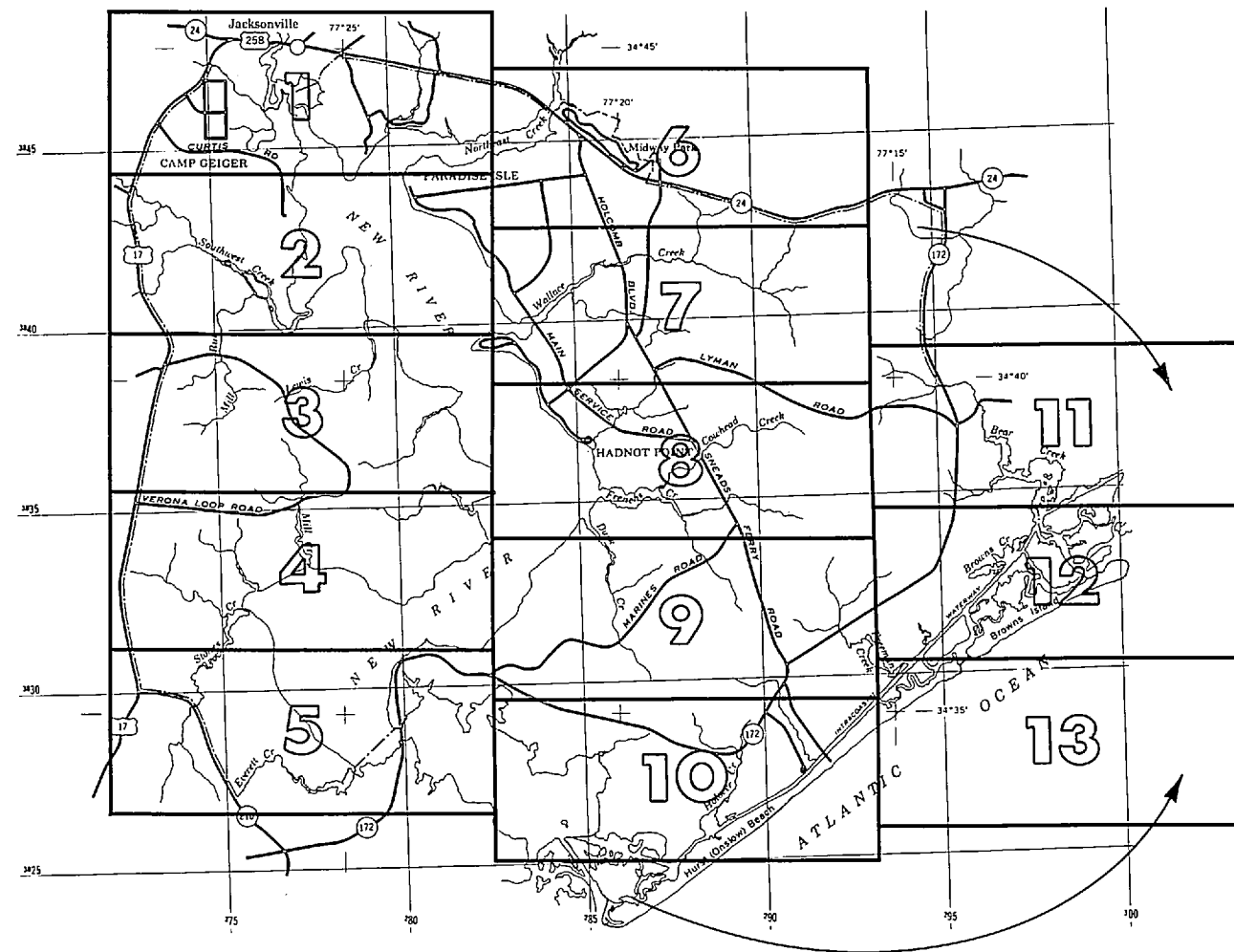

CAMP LEJEUNE  
USMC RESERVATION  
ONSLOW COUNTY, NORTH CAROLINA





Handwritten text, possibly bleed-through from the reverse side of the page, appearing as a vertical line of characters on the right edge.

NATURAL RESOURCES CONSERVATION PLAN  
 CAMP LEJEUNE USMC RESERVATION  
 ONSLOW COUNTY, NORTH CAROLINA

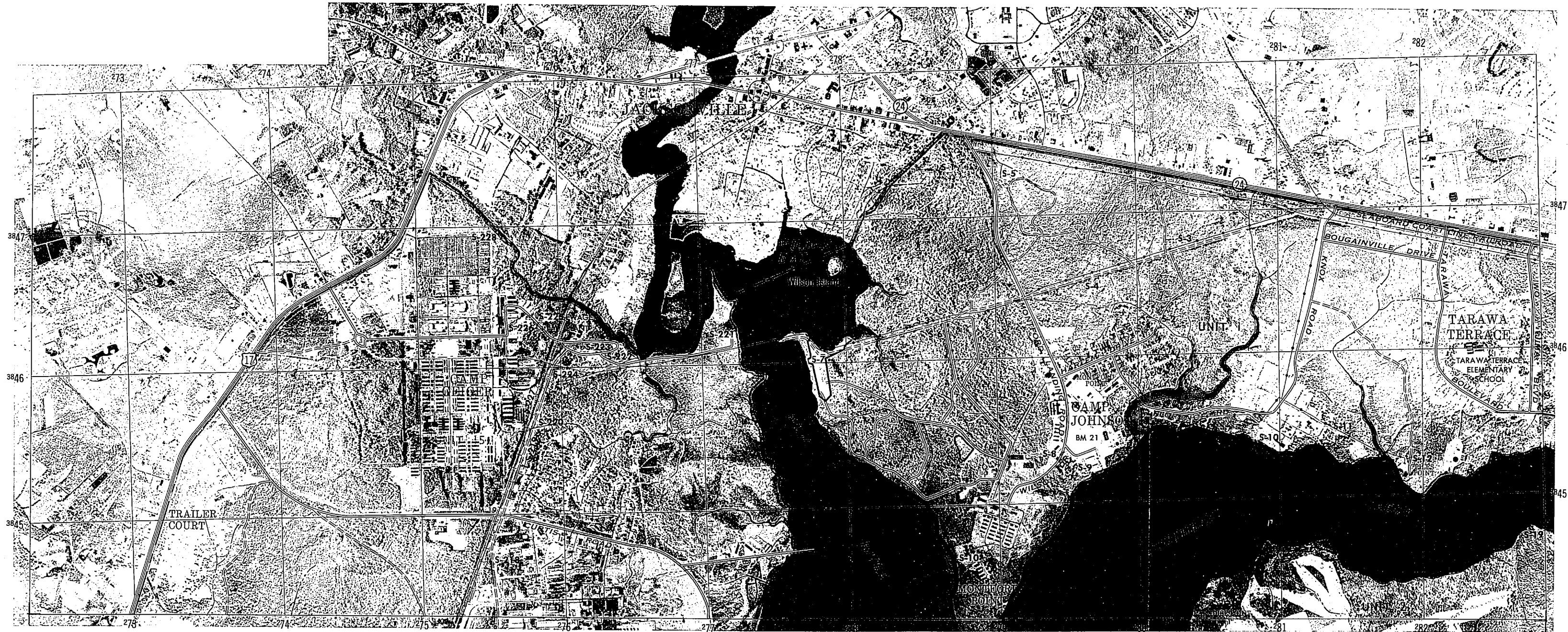
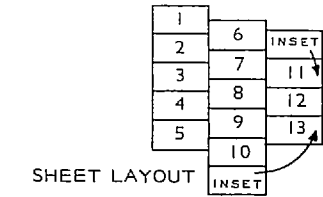

(Joins sheet 6)

(Joins sheet 2)

Semiconrolled Mosaic of 1973 Photography  
 Prepared by USDA, Soil Conservation Service  
 Cartographic Unit, Fort Worth, Texas.

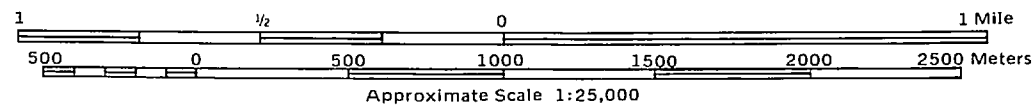

Handwritten text, possibly bleed-through from the reverse side of the page, appearing as a vertical line of characters.

NATURAL RESOURCES CONSERVATION PLAN  
 CAMP LEJEUNE USMC RESERVATION  
 ONSLOW COUNTY, NORTH CAROLINA

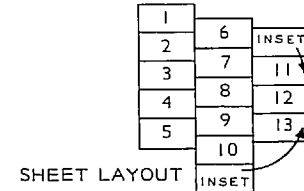

(Joins sheet 1 )

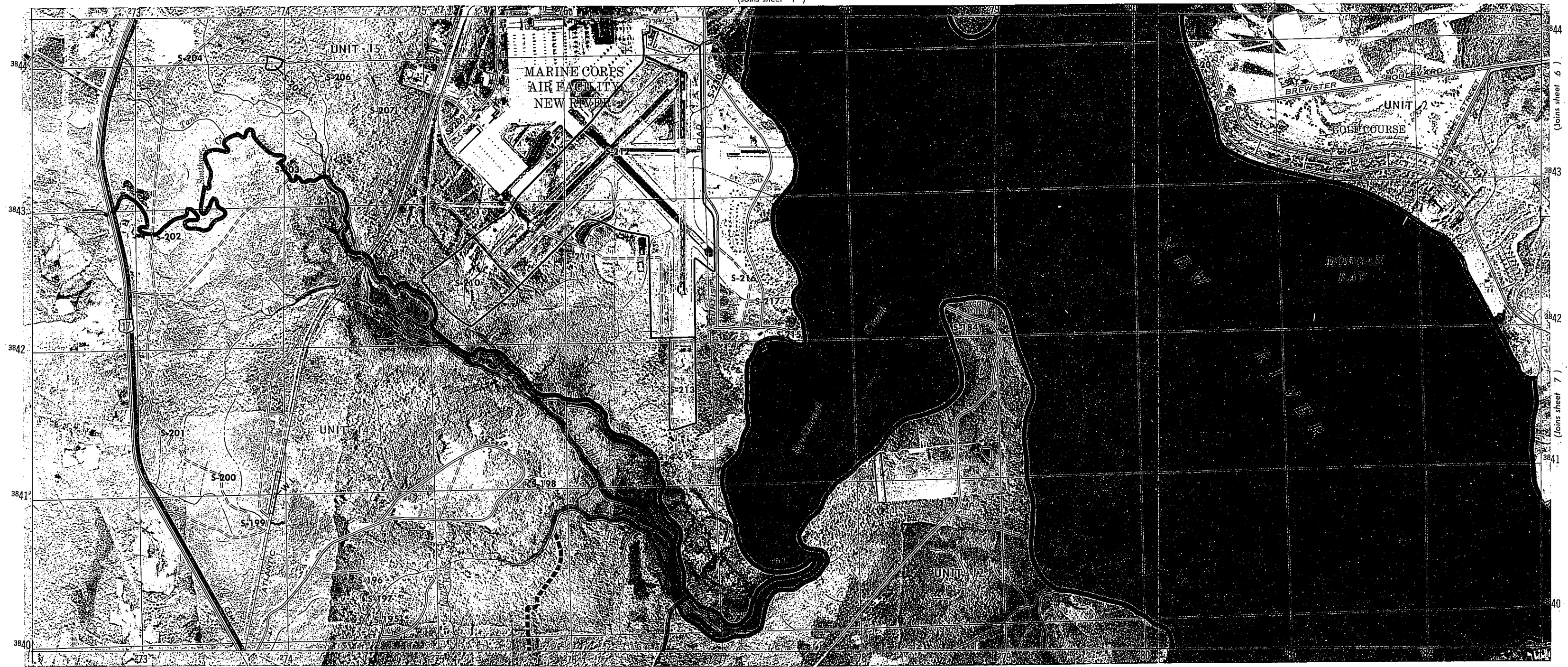

(Joins sheet 3 )

Semiconrolled Mosaic of 1973 Photography  
 Prepared by USDA, Soil Conservation Service  
 Cartographic Unit, Fort Worth, Texas.

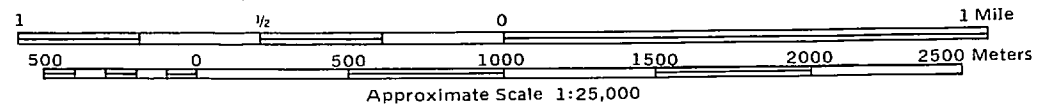



# NATURAL RESOURCES CONSERVATION PLAN CAMP LEJEUNE USMC RESERVATION ONslow COUNTY, NORTH CAROLINA

1	6	INSET
2	7	11
3	8	12
4	9	13
5	10	INSET

SHEET LAYOUT

(Joins sheet 2)

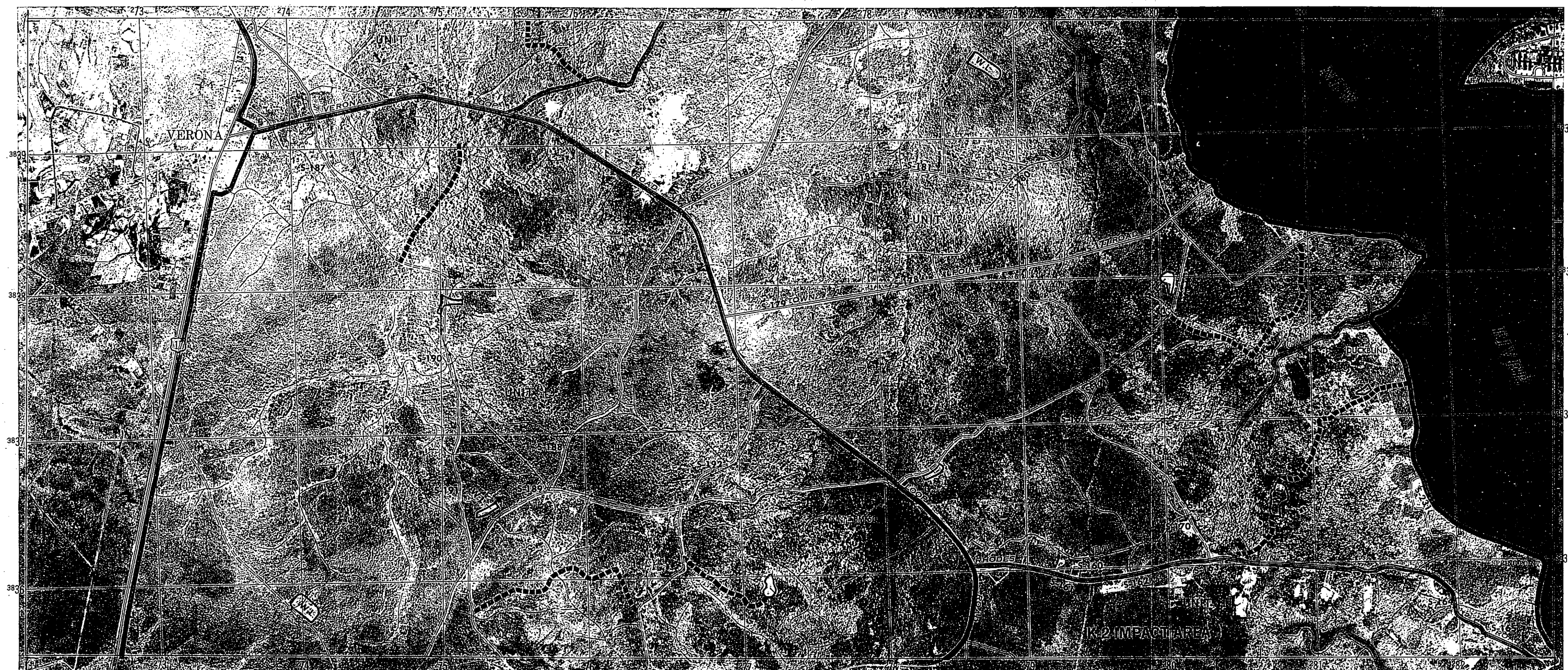

(Joins sheet 7)

(Joins sheet 8)

(Joins sheet 4)

Semiconrolled Mosaic of 1973 Photography  
Prepared by USDA, Soil Conservation Service  
Cartographic Unit, Fort Worth, Texas.

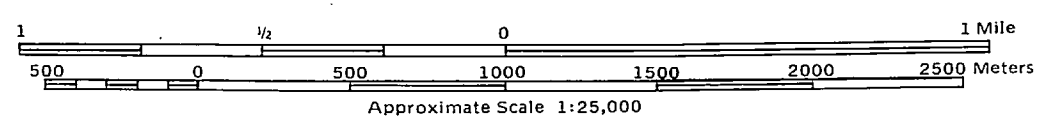



# NATURAL RESOURCES CONSERVATION PLAN CAMP LEJEUNE USMC RESERVATION ONSLOW COUNTY, NORTH CAROLINA

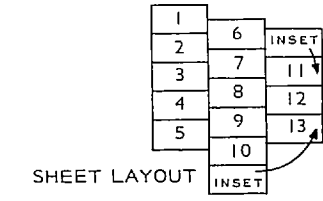

(Joins sheet 3 )

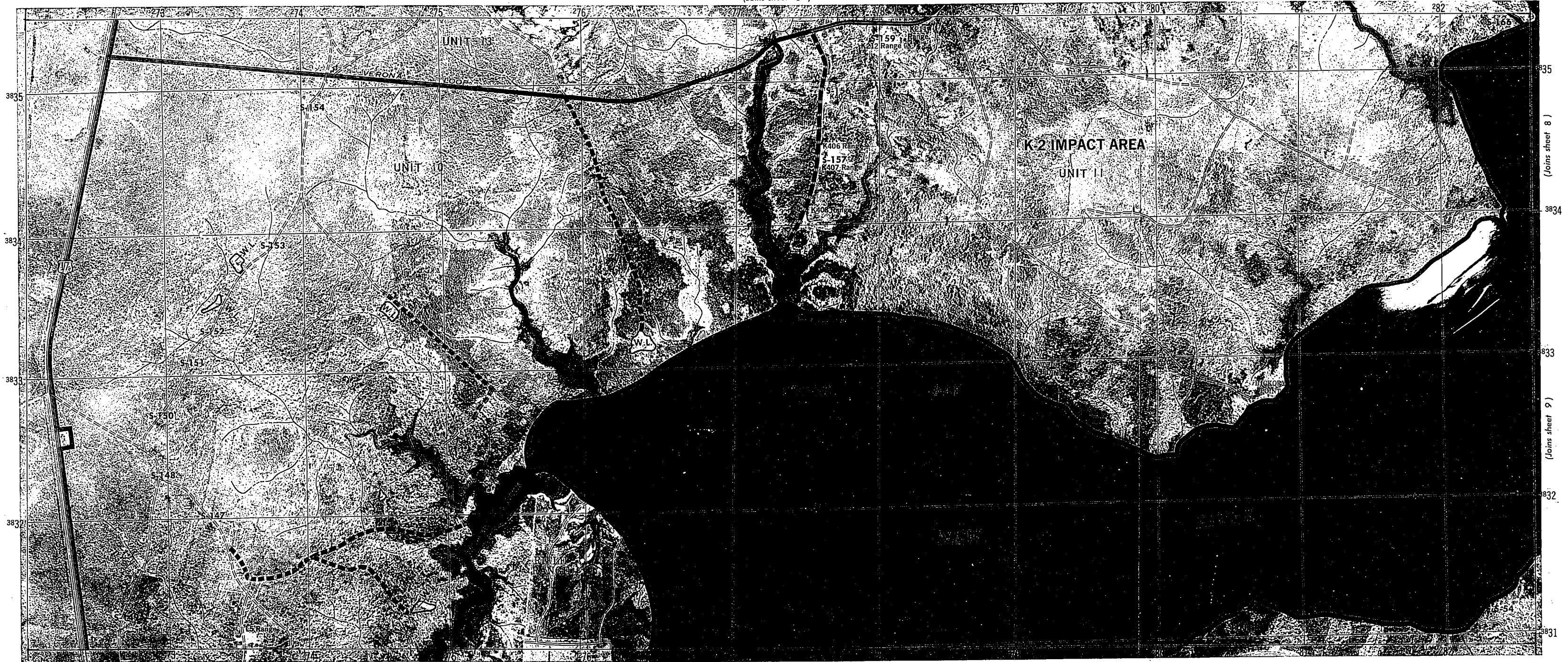

(Joins sheet 8 )

(Joins sheet 9 )

(Joins sheet 5 )

Semiconrolled Mosaic of 1973 Photography  
Prepared by USDA, Soil Conservation Service  
Cartographic Unit, Fort Worth, Texas.

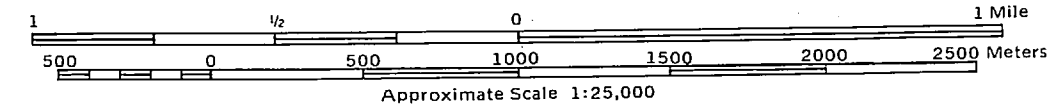





# NATURAL RESOURCES CONSERVATION PLAN CAMP LEJEUNE USMC RESERVATION ONSLOW COUNTY, NORTH CAROLINA

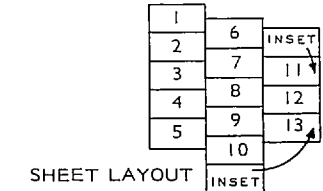

(Joins sheet 4 )

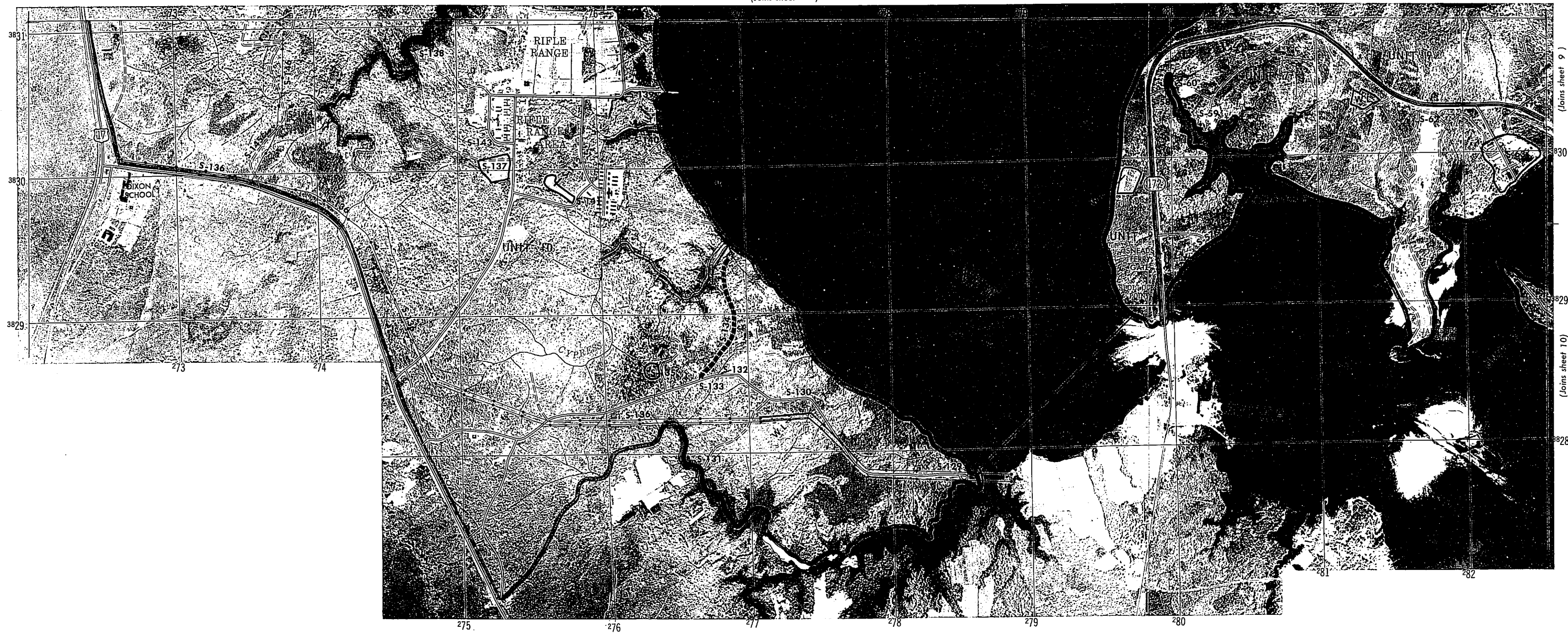

Semiconrolled Mosaic of 1973 Photography  
Prepared by USDA, Soil Conservation Service  
Cartographic Unit, Fort Worth, Texas.

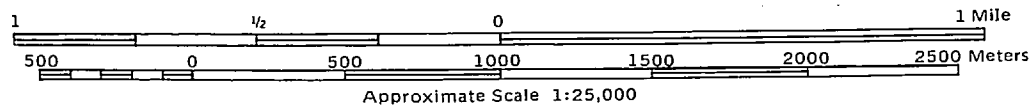

1870

NATURAL RESOURCES CONSERVATION PLAN  
 CAMP LEJEUNE USMC RESERVATION  
 ONSLOW COUNTY, NORTH CAROLINA

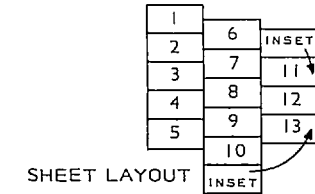

Semiconrolled Mosaic of 1973 Photography  
 Prepared by USDA, Soil Conservation Service  
 Cartographic Unit, Fort Worth, Texas.

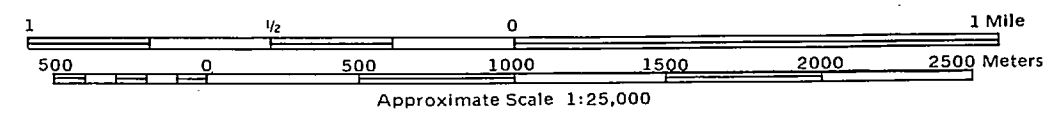



NATURAL RESOURCES CONSERVATION PLAN  
**CAMP LEJEUNE USMC RESERVATION**  
 ONSLOW COUNTY, NORTH CAROLINA

SHEET 7

1	6	INSET
2	7	11
3	8	12
4	9	13
5	10	INSET

SHEET LAYOUT

(Joins sheet 6 )



(Joins sheet 2 )

(Joins sheet 3 )

(Joins sheet 11 )

(Joins sheet 8 )

Semicontrolled Mosaic of 1973 Photography  
 Prepared by USDA, Soil Conservation Service  
 Cartographic Unit, Fort Worth, Texas.

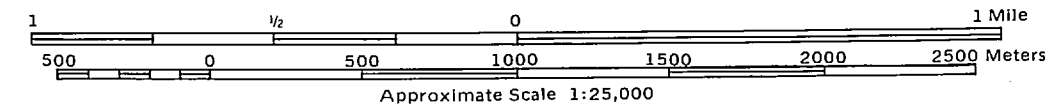

1875

NATURAL RESOURCES CONSERVATION PLAN  
**CAMP LEJEUNE USMC RESERVATION**  
 ONSLOW COUNTY, NORTH CAROLINA

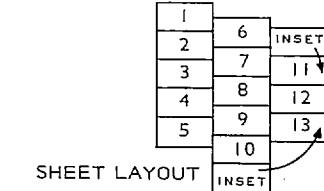

Semiconrolled Mosaic of 1973 Photography  
 Prepared by USDA, Soil Conservation Service  
 Cartographic Unit, Fort Worth, Texas.

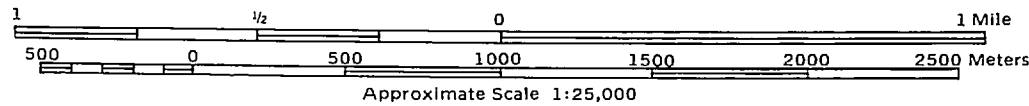



1  
2  
3  
4  
5  
6  
7  
8  
9  
10  
11  
12  
13  
14  
15  
16  
17  
18  
19  
20  
21  
22  
23  
24  
25  
26  
27  
28  
29  
30  
31  
32  
33  
34  
35  
36  
37  
38  
39  
40  
41  
42  
43  
44  
45  
46  
47  
48  
49  
50  
51  
52  
53  
54  
55  
56  
57  
58  
59  
60  
61  
62  
63  
64  
65  
66  
67  
68  
69  
70  
71  
72  
73  
74  
75  
76  
77  
78  
79  
80  
81  
82  
83  
84  
85  
86  
87  
88  
89  
90  
91  
92  
93  
94  
95  
96  
97  
98  
99  
100

NATURAL RESOURCES CONSERVATION PLAN  
 CAMP LEJEUNE USMC RESERVATION  
 ONSLOW COUNTY, NORTH CAROLINA

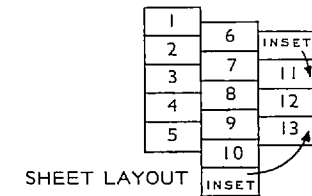

(Joins sheet 8 )

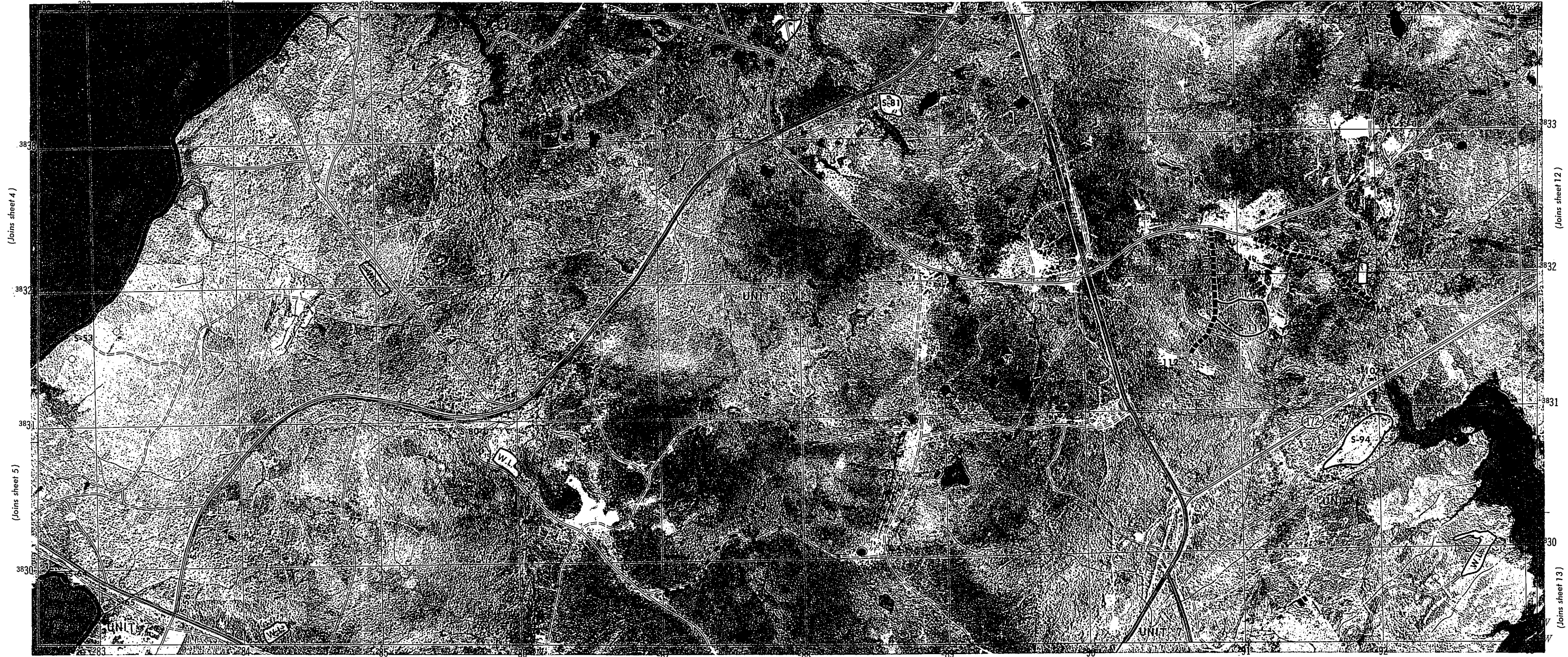

(Joins sheet 4 )

(Joins sheet 5 )

(Joins sheet 12 )

(Joins sheet 13 )

(Joins sheet 10 )

Semiconrolled Mosaic of 1973 Photography  
 Prepared by USDA, Soil Conservation Service  
 Cartographic Unit, Fort Worth, Texas.

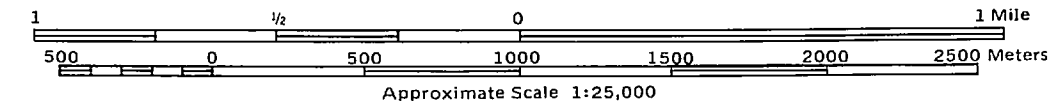



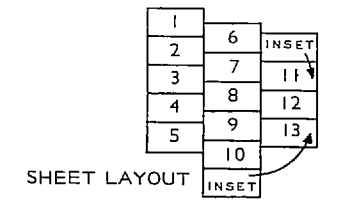

(Joins sheet 9)

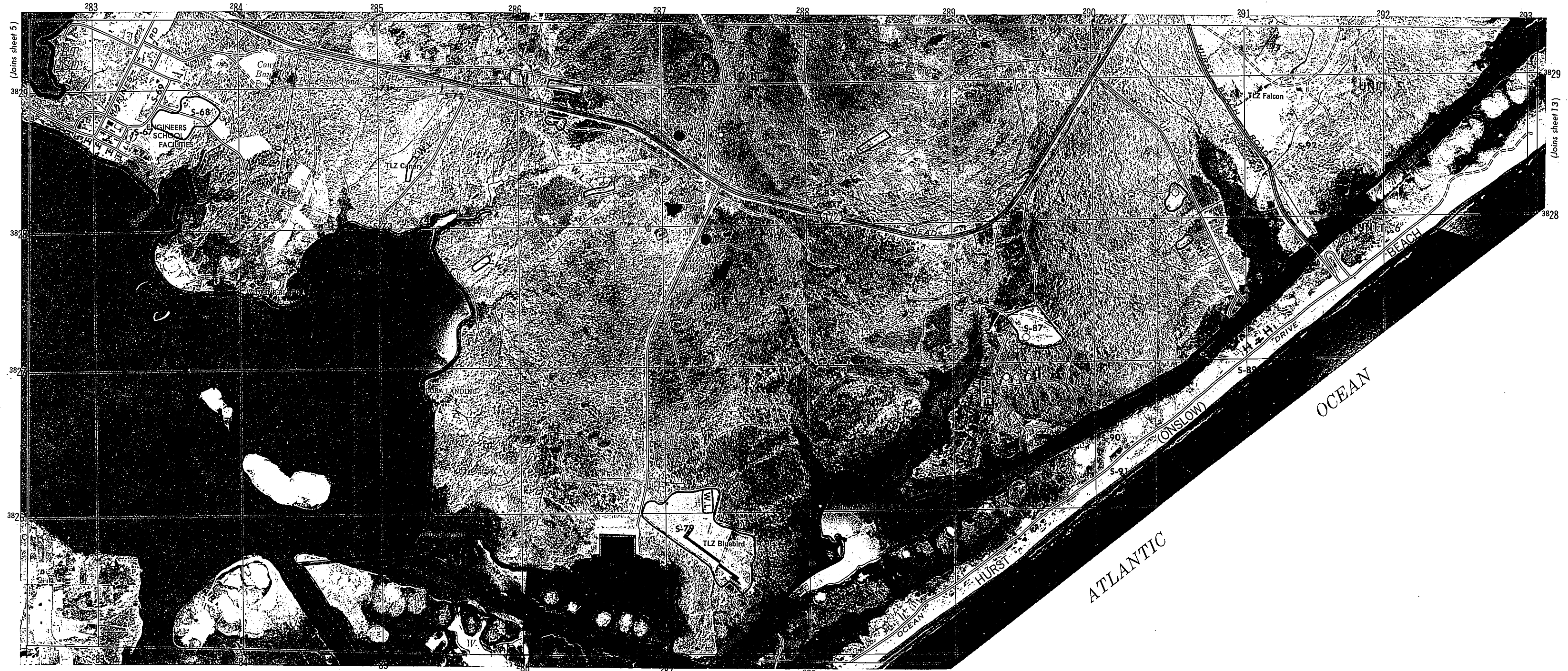

(Joins sheet 5)

(Joins sheet 13)

(Joins inset, sheet 13)

Semiconrolled Mosaic of 1973 Photography  
Prepared by USDA, Soil Conservation Service  
Cartographic Unit, Fort Worth, Texas.

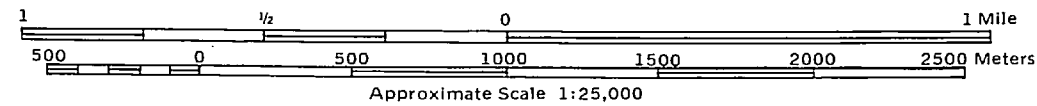



# NATURAL RESOURCES CONSERVATION PLAN CAMP LEJEUNE USMC RESERVATION ONSLOW COUNTY, NORTH CAROLINA

1	6	INSET
2	7	11
3	8	12
4	9	13
5	10	
	INSET	

SHEET LAYOUT

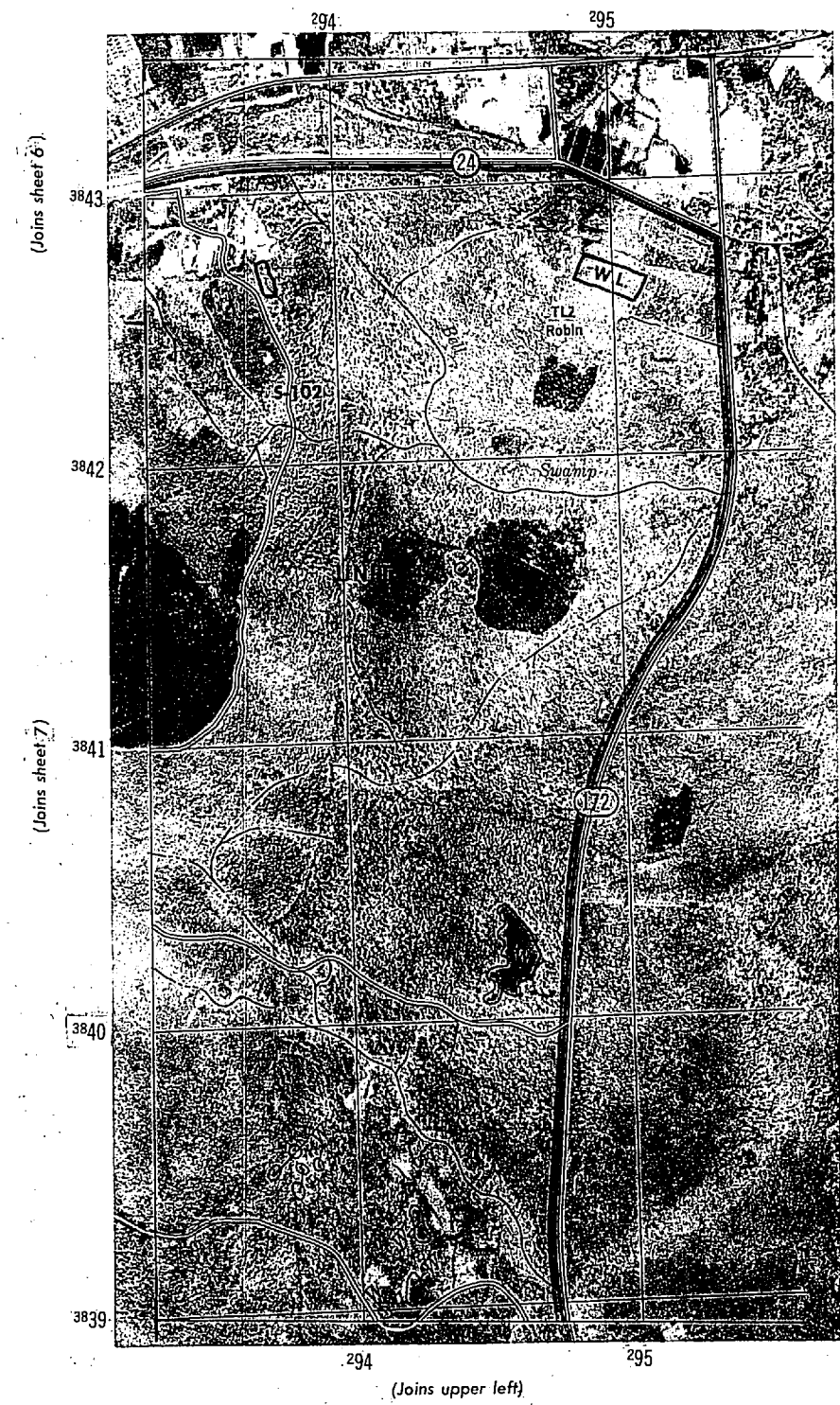
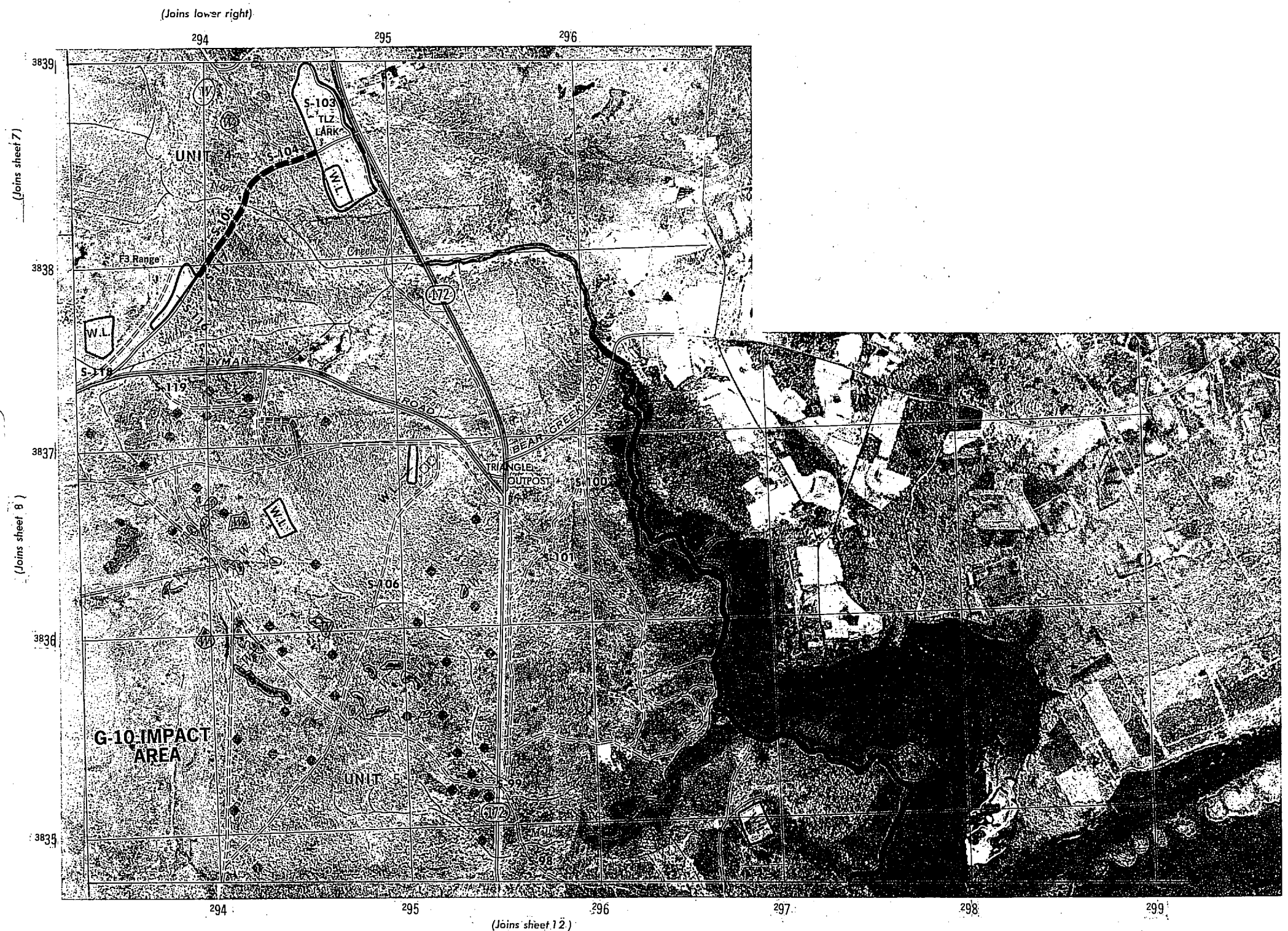

Semiconrolled Mosaic of 1973 Photography  
Prepared by USDA, Soil Conservation Service  
Cartographic Unit, Fort Worth, Texas.

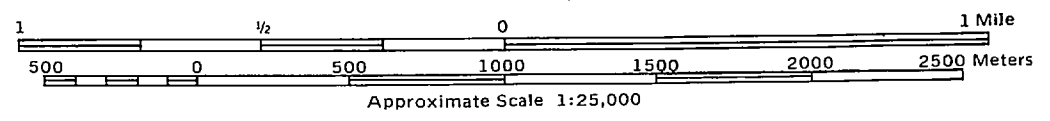

1870

# NATURAL RESOURCES CONSERVATION PLAN CAMP LEJEUNE USMC RESERVATION ONslow COUNTY, NORTH CAROLINA

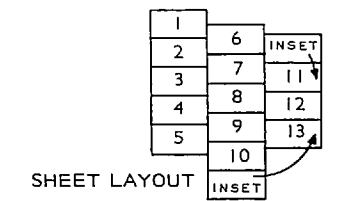

(Joins sheet 11 )

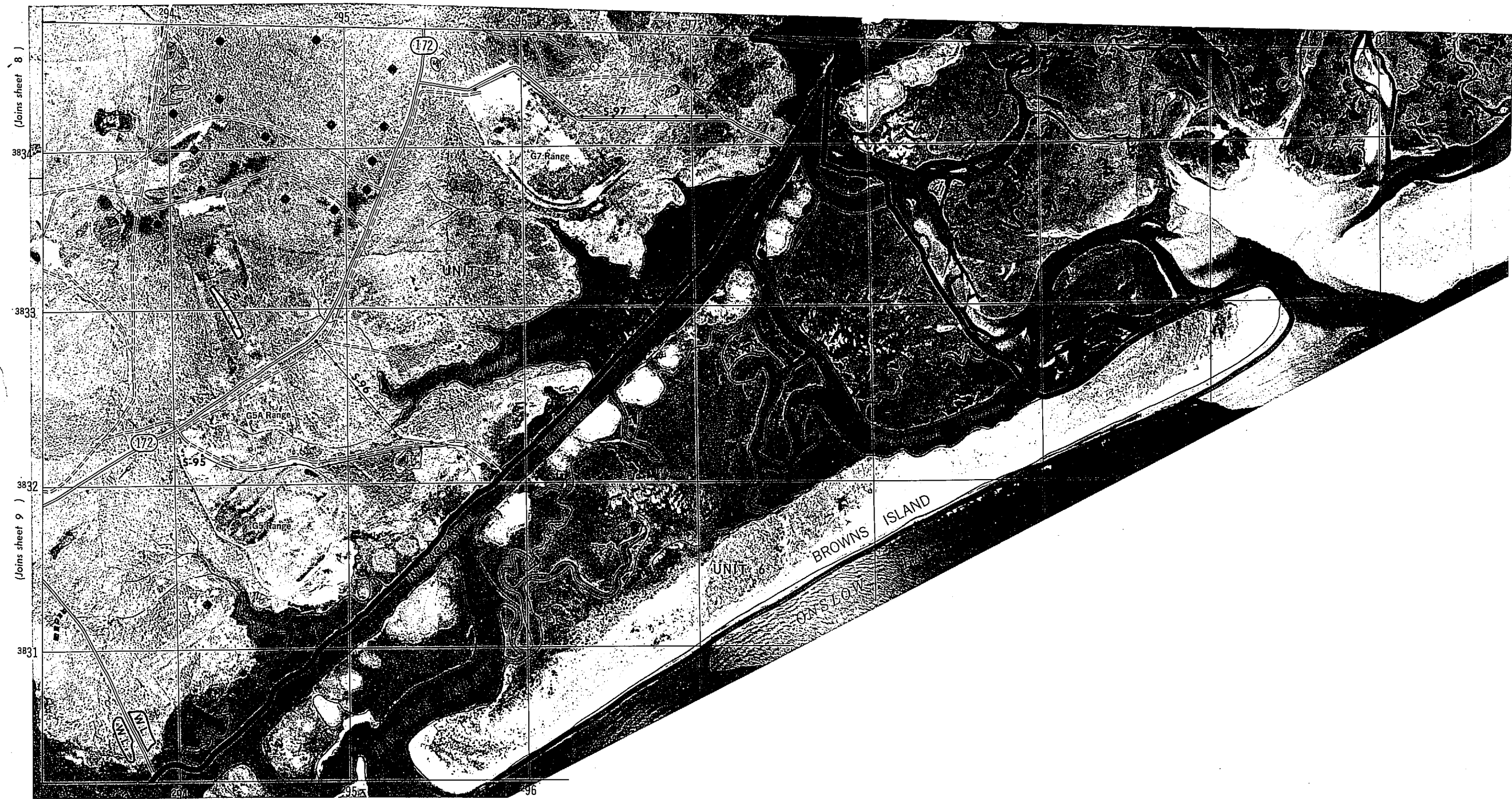

Semiconrolled Mosaic of 1973 Photography  
Prepared by USDA, Soil Conservation Service  
Cartographic Unit, Fort Worth, Texas.

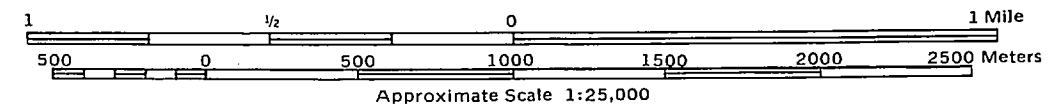



Handwritten text, possibly bleed-through from the reverse side of the page, located at the top edge.

# NATURAL RESOURCES CONSERVATION PLAN CAMP LEJEUNE USMC RESERVATION ONSLOW COUNTY, NORTH CAROLINA

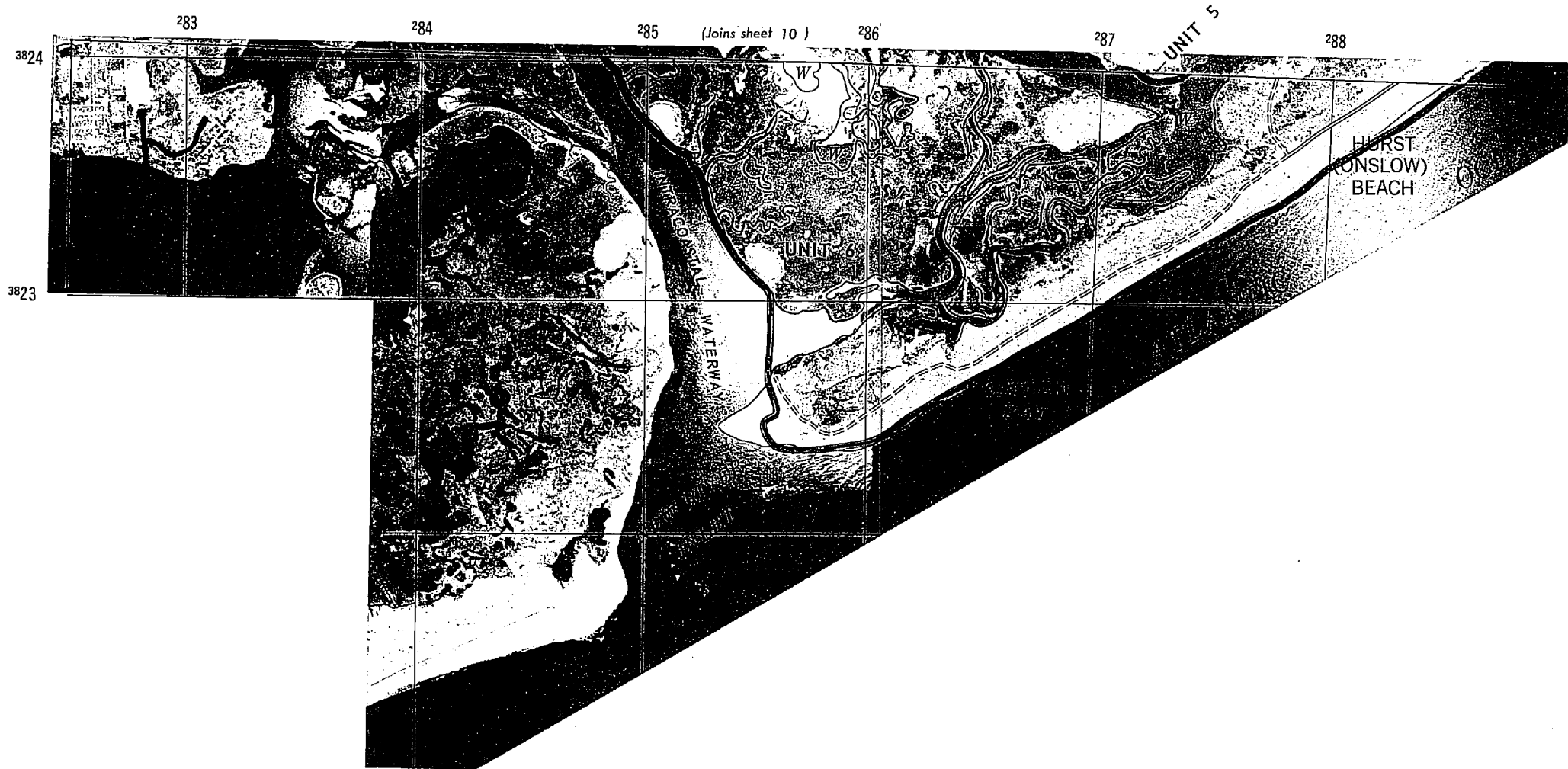
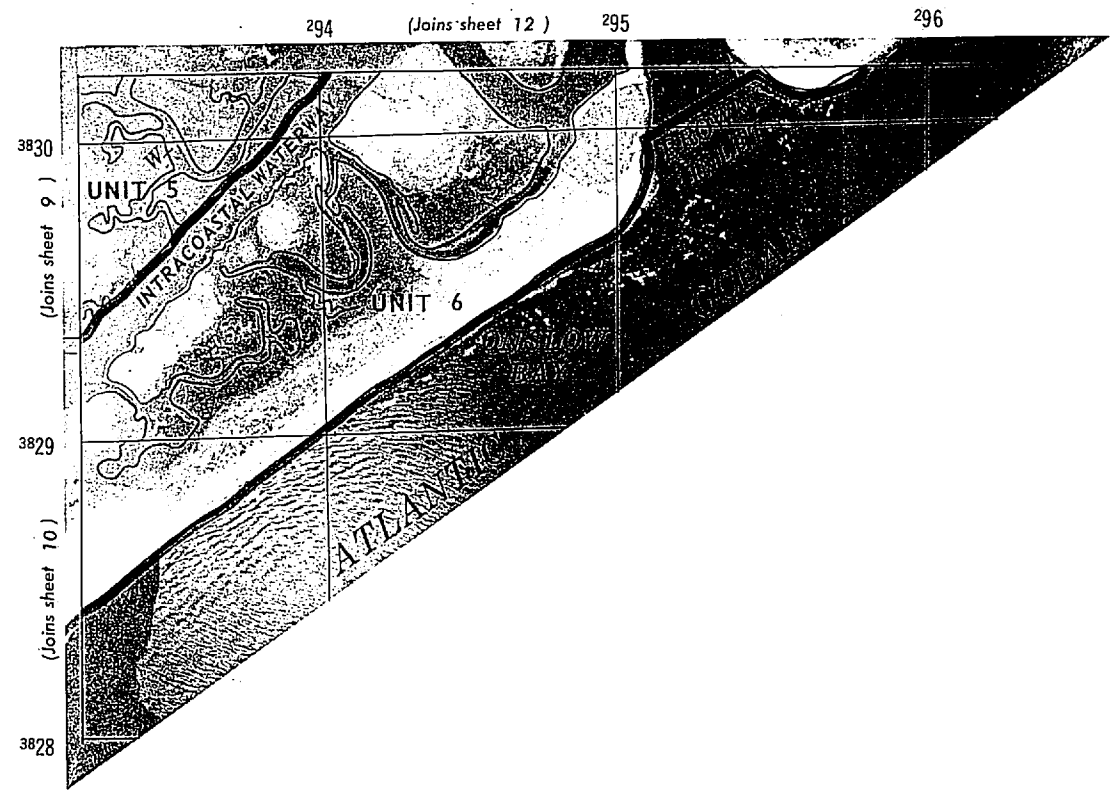
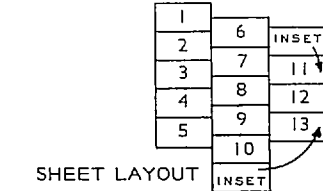



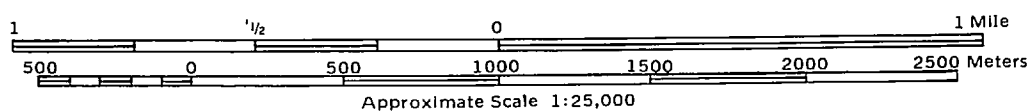







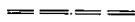
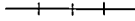

Semiconrolled Mosaic of 1973 Photography  
Prepared by USDA, Soil Conservation Service  
Cartographic Unit, Fort Worth, Texas.



Handwritten text, possibly bleed-through from the reverse side of the page, located at the bottom edge.

OAK GROVE  
 CAMP LEJEUNE USMC OUTLYING FIELD  
 JONES COUNTY, NORTH CAROLINA

- LEGEND
-  Divided Highway
  -  Good Motor Road
  -  Poor Motor Road
  -  Railroad
  -  Project Boundary
  -  County Line
  -  Power Line
  -  Forest Fire Lookout Station
  -  Cemetery
  -  School
  -  Groins
  -  Borrow Pit
  -  Drainage
  -  Pond or Lake

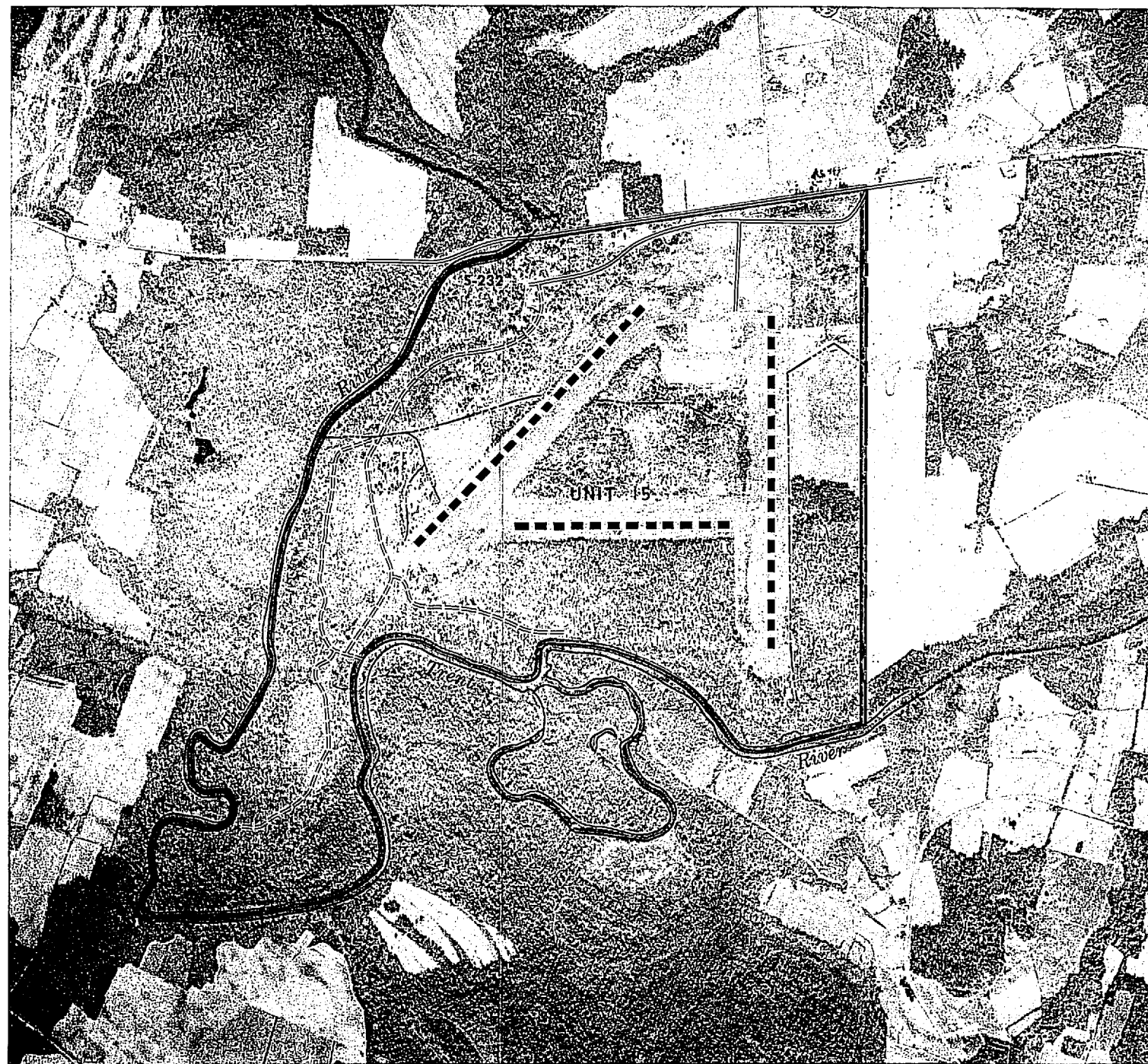

Semiconrolled Mosaic of 1973 Photography  
 Prepared by USDA, Soil Conservation Service  
 Cartographic Unit, Fort Worth, Texas.

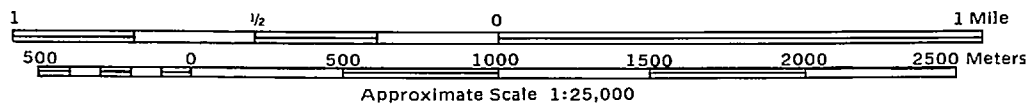

1875

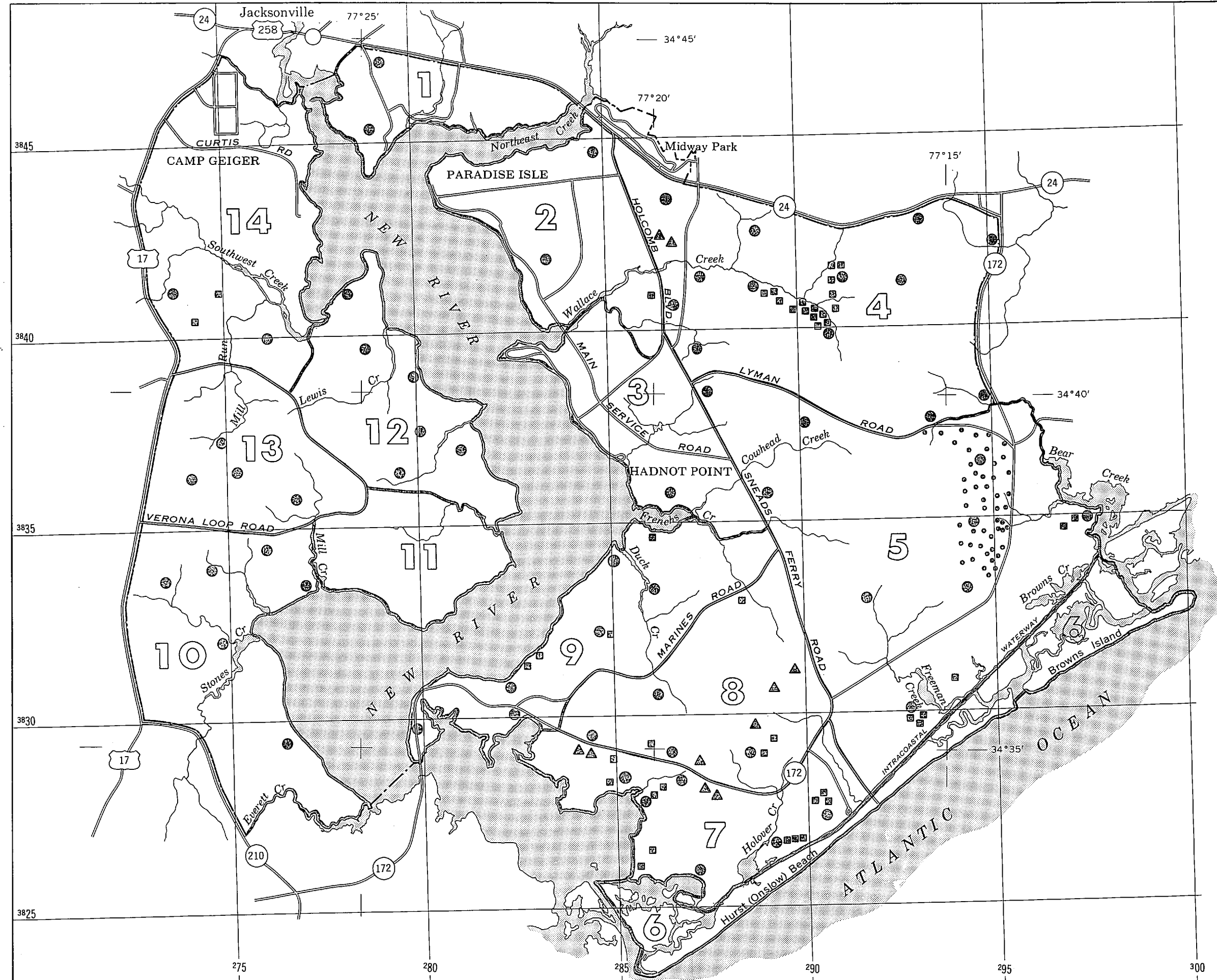

- LEGEND
- WILDLIFE FOOD PLOTS
  - ▲ FISH PONDS
  - WILDLIFE OPENINGS
  - SMALL GAME PLOTS
  - 2 WILDLIFE UNIT NUMBER
  - WILDLIFE UNIT BOUNDARIES

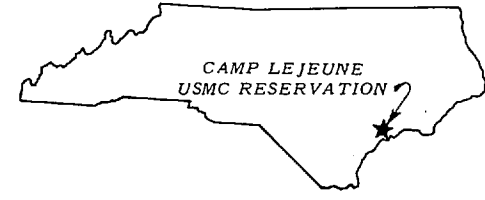

VICINITY MAP

MAP OF WILDLIFE UNITS  
**CAMP LEJEUNE**  
**USMC RESERVATION**  
**ONSLow COUNTY, NORTH CAROLINA**

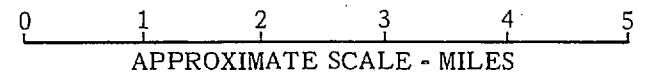











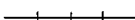

TRANSVERSE MERCATOR PROJECTION COMPILED AND REPRODUCED AT 1:100,000 (1 INCH EQUALS 1.58 MILES)

BASE COMPILED FROM U.S. DEPT. OF DEFENSE COMBAT TRAINING CHART MAP.



1 2 3 4 5 6 7 8 9 10 11 12 13 14 15 16 17 18 19 20 21 22 23 24 25 26 27 28 29 30 31 32 33 34 35 36 37 38 39 40 41 42 43 44 45 46 47 48 49 50 51 52 53 54 55 56 57 58 59 60 61 62 63 64 65 66 67 68 69 70 71 72 73 74 75 76 77 78 79 80 81 82 83 84 85 86 87 88 89 90 91 92 93 94 95 96 97 98 99 100

LEGEND

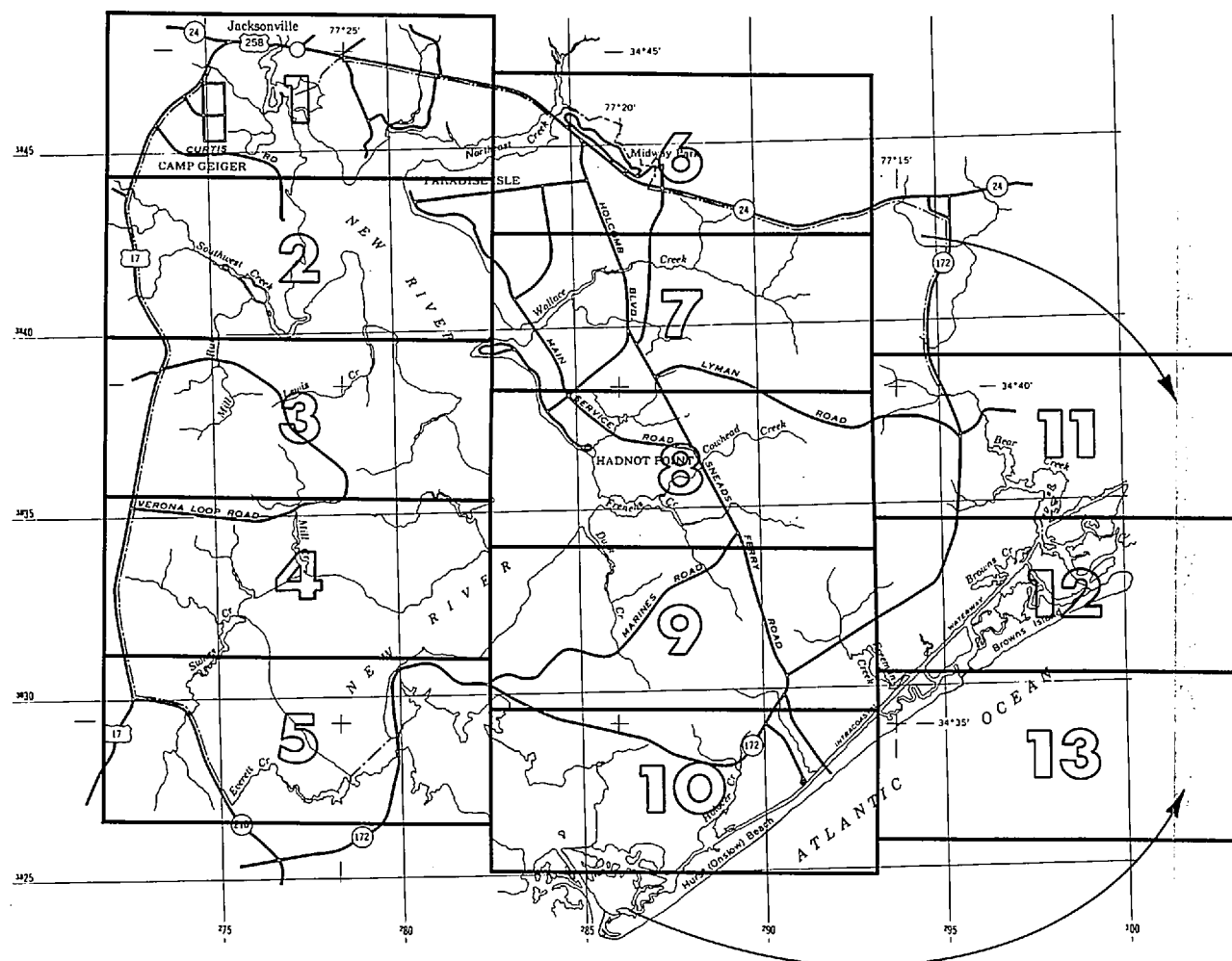
-  Divided Highway
-  Good Motor Road
-  Poor Motor Road
-  Railroad
-  Project Boundary
-  County Line
-  Power Line
-  Forest Fire Lookout Station
-  Cemetery
-  School
-  Groins
-  Borrow Pit
-  Drainage
-  Pond or Lake



FORESTRY PLAN MAP LEGEND

-  Stand Boundary
-  Compartment Boundary
- Compartment No. 13-3 Stand No.
- Forest Type 134 Size Class

Size Class	
Non - Stocked	1
Seedling - Sapling	2
Pole Timber	3
Saw Timber	4

Forest Type	
Long Leaf Pine	01
Slash Pine	02
Loblolly Pine	13
Pond Pine	18
Loblolly - Hardwood	43
Pond Pine - Hardwood	48
Scrub Oak	54
Sweet Gum - Water Oak	91
Elm - Ash	92
White Oak - Red Oak	93
Cypress - Tupelo	95
Black Gum - Red Maple	96
Non Forested	-1

1 in = 3.2 miles

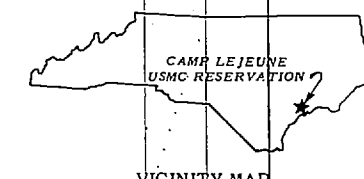

CAMP LEJEUNE  
USMC RESERVATION  
ONSLOW COUNTY, NORTH CAROLINA

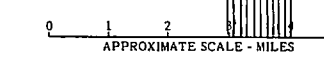



Handwritten text, possibly bleed-through from the reverse side of the page, located at the bottom edge.

NATURAL RESOURCES CONSERVATION PLAN  
 CAMP LEJEUNE USMC RESERVATION  
 ONSLOW COUNTY, NORTH CAROLINA

1	6	INSET
2	7	11
3	8	12
4	9	13
5	10	INSET

SHEET LAYOUT

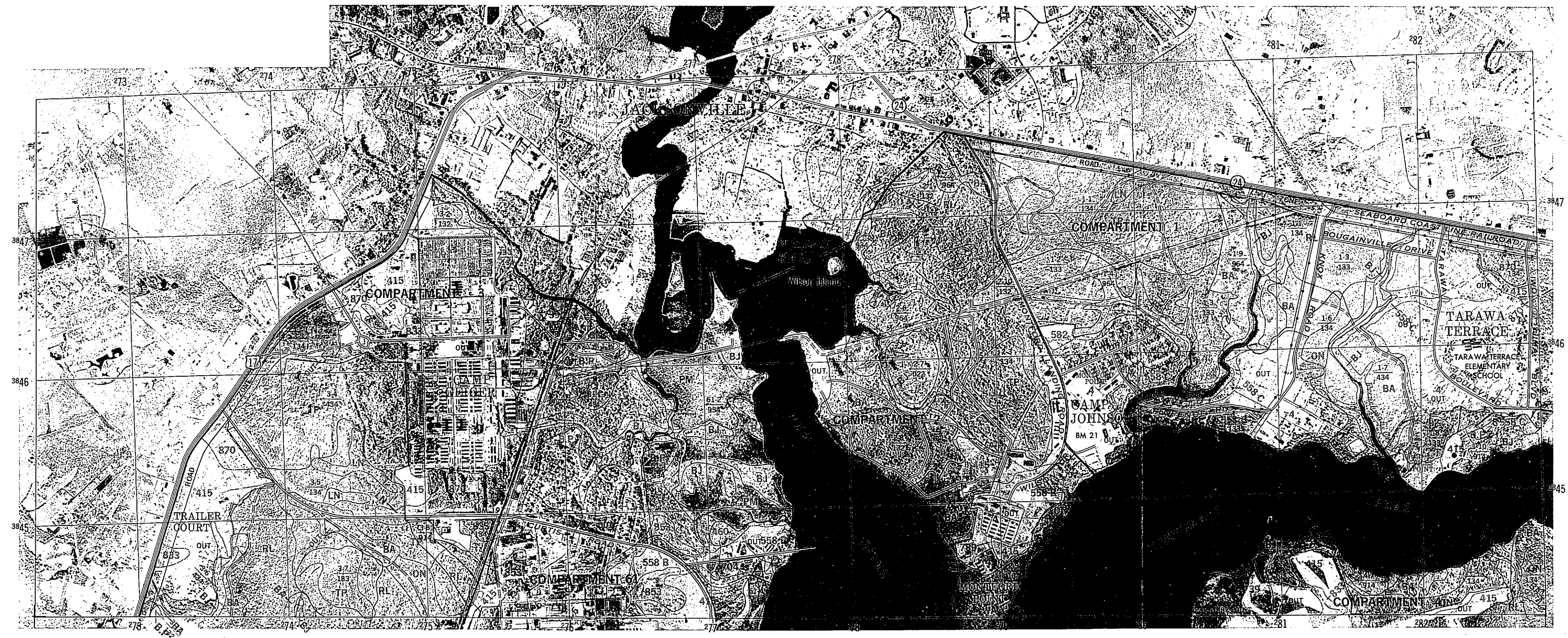

(Joins sheet 2)

Semiconrolled Mosaic of 1973 Photography  
 Prepared by USDA, Soil Conservation Service  
 Cartographic Unit, Fort Worth, Texas.

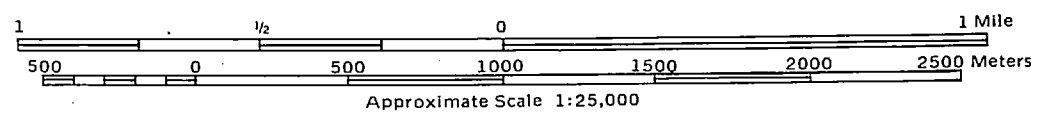

Handwritten text, possibly bleed-through from the reverse side of the page, located at the bottom right corner.

NATURAL RESOURCES CONSERVATION PLAN  
 CAMP LEJEUNE USMC RESERVATION  
 ONSLOW COUNTY, NORTH CAROLINA

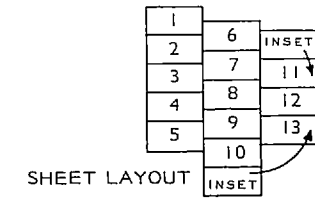

(Joins sheet 1 )



(Joins sheet 3 )

Semiconrolled Mosaic of 1973 Photography  
 Prepared by USDA, Soil Conservation Service  
 Cartographic Unit, Fort Worth, Texas.

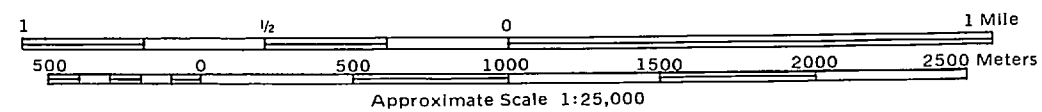

Handwritten text, possibly bleed-through from the reverse side of the page, located at the bottom right corner.

# NATURAL RESOURCES CONSERVATION PLAN CAMP LEJEUNE USMC RESERVATION ONslow COUNTY, NORTH CAROLINA

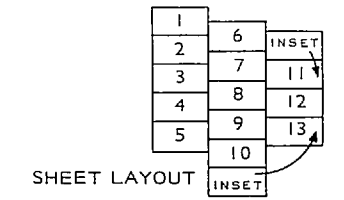

(Joins sheet 2.)

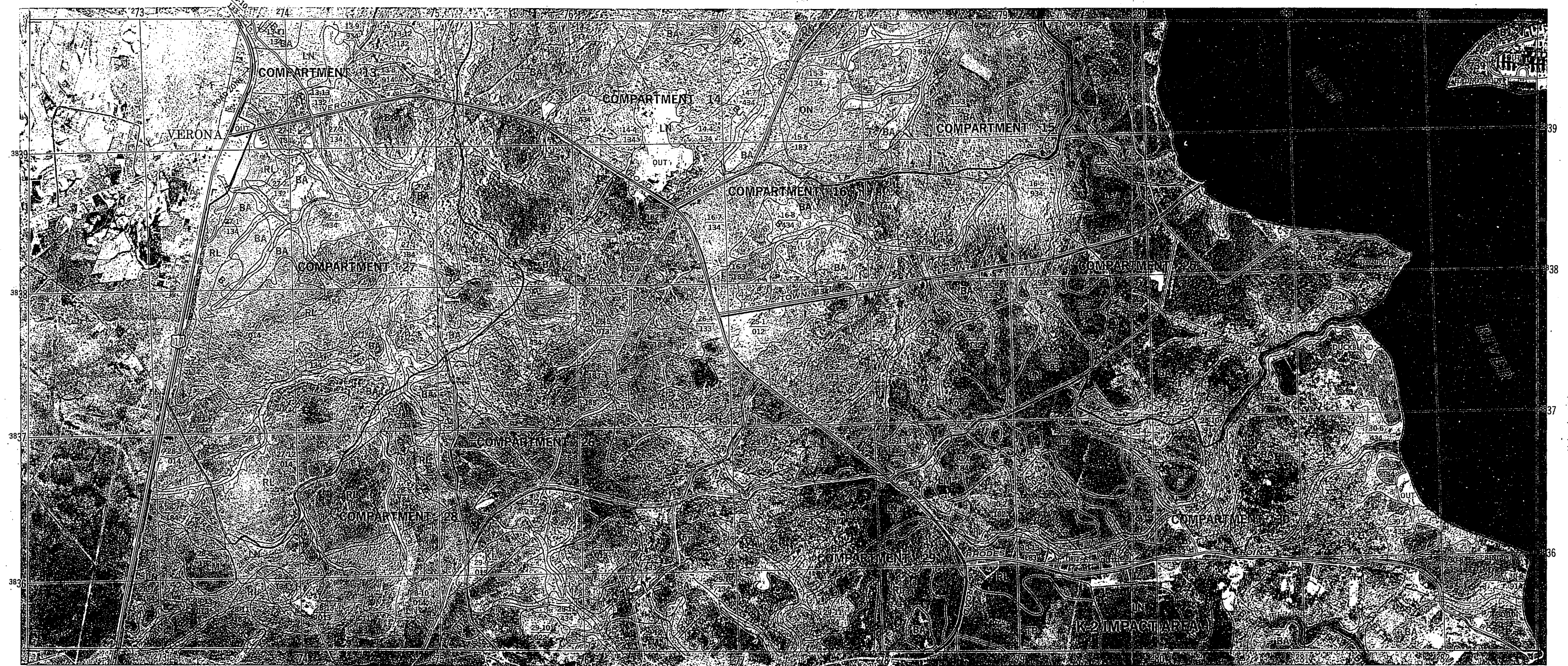

(Joins sheet 7.)

(Joins sheet 8.)

(Joins sheet 4.)

Semicontrolled Mosaic of 1973 Photography  
Prepared by USDA, Soil Conservation Service  
Cartographic Unit, Fort Worth, Texas.

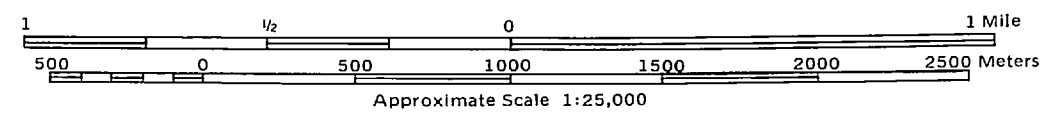



# NATURAL RESOURCES CONSERVATION PLAN CAMP LEJEUNE USMC RESERVATION ONSLOW COUNTY, NORTH CAROLINA

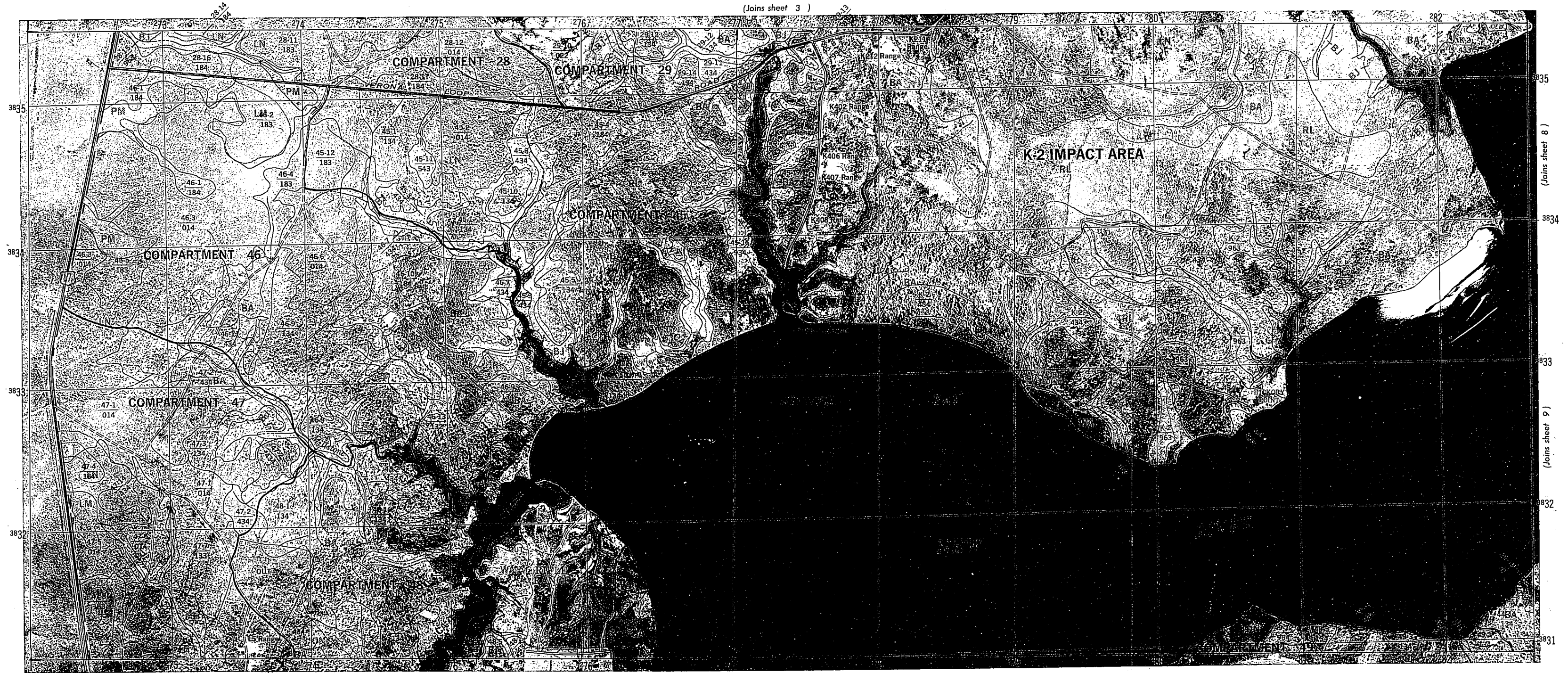
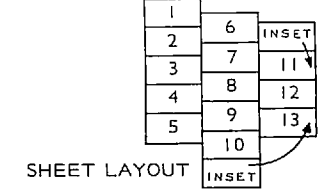

(Joins sheet 3 )

3835

(Joins sheet 8 )

3834

3833

(Joins sheet 9 )

3832

3831

(Joins sheet 5 )

Semiconrolled Mosaic of 1973 Photography  
Prepared by USDA, Soil Conservation Service  
Cartographic Unit, Fort Worth, Texas.

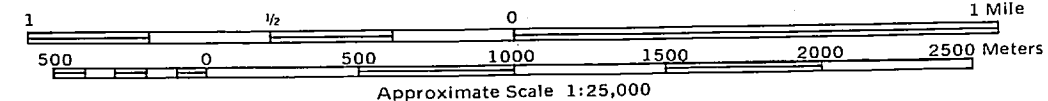





NATURAL RESOURCES CONSERVATION PLAN  
 CAMP LEJEUNE USMC RESERVATION  
 ONSLOW COUNTY, NORTH CAROLINA

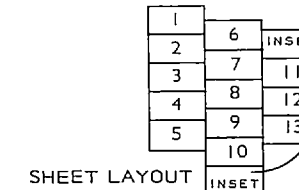

(Joins sheet 4 )

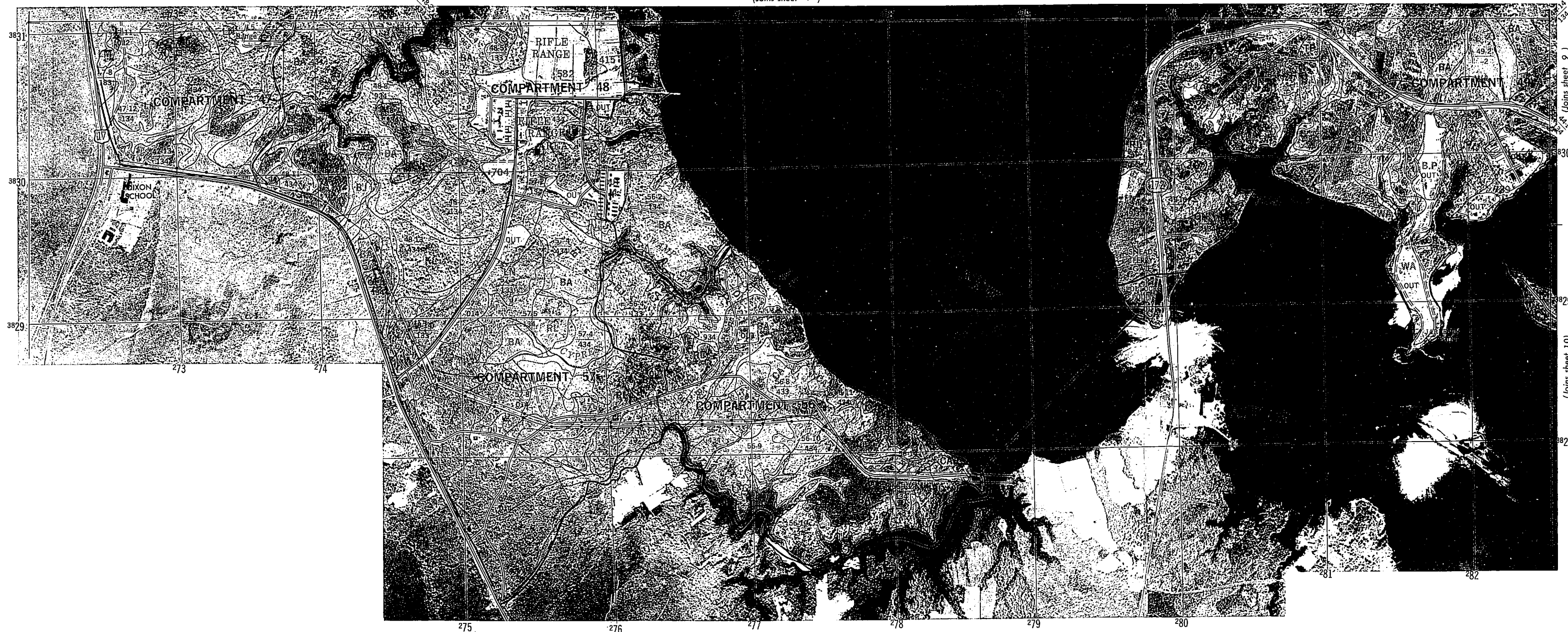

Semiconrolled Mosaic of 1973 Photography  
 Prepared by USDA, Soil Conservation Service  
 Cartographic Unit, Fort Worth, Texas.

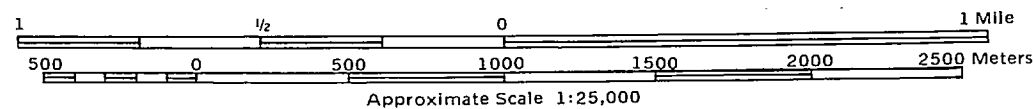

1872

# NATURAL RESOURCES CONSERVATION PLAN CAMP LEJEUNE USMC RESERVATION ONSLOW COUNTY, NORTH CAROLINA

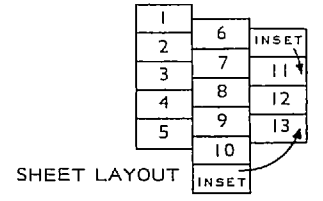

Semicontrolled Mosaic of 1973 Photography  
Prepared by USDA, Soil Conservation Service  
Cartographic Unit, Fort Worth, Texas.

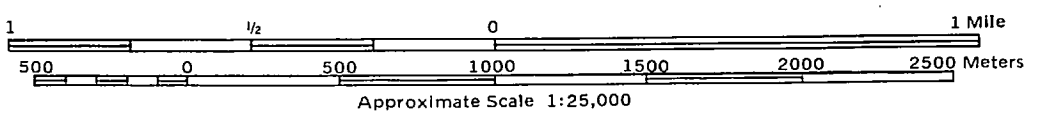

1872

NATURAL RESOURCES CONSERVATION PLAN  
**CAMP LEJEUNE USMC RESERVATION**  
 ONSLOW COUNTY, NORTH CAROLINA

1	6	INSET
2	7	11
3	8	12
4	9	13
5	10	INSET

SHEET LAYOUT

(Joins sheet 6 )

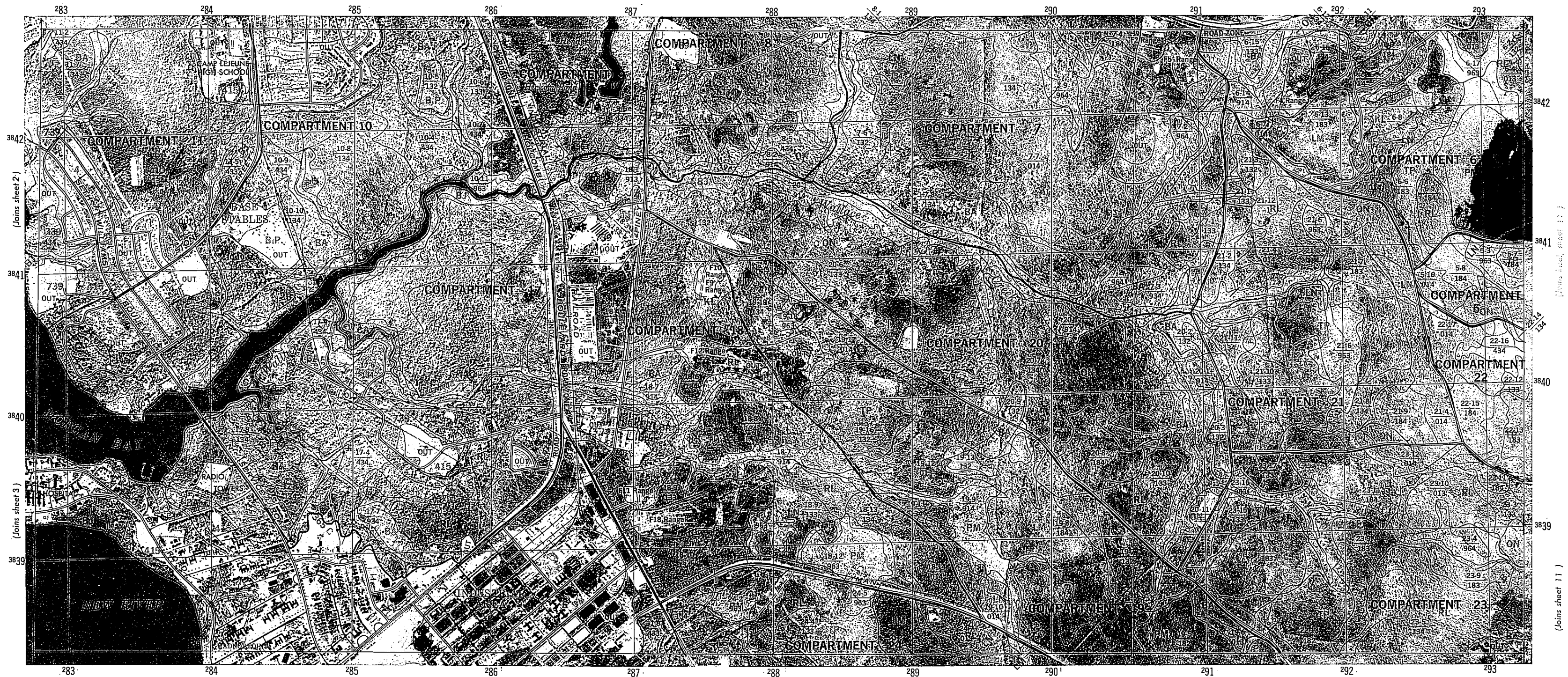

(Joins sheet 2)

(Joins sheet 3)

(Joins sheet 11)

(Joins sheet 11)

(Joins sheet 8 )

Semiconrolled Mosaic of 1973 Photography  
 Prepared by USDA, Soil Conservation Service  
 Cartographic Unit, Fort Worth, Texas.

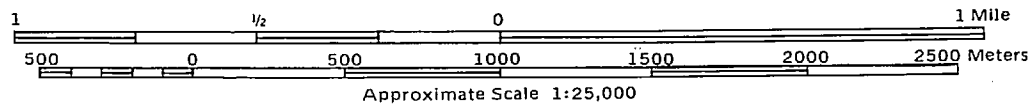

1872

NATURAL RESOURCES CONSERVATION PLAN  
 CAMP LEJEUNE USMC RESERVATION  
 ONSLOW COUNTY, NORTH CAROLINA

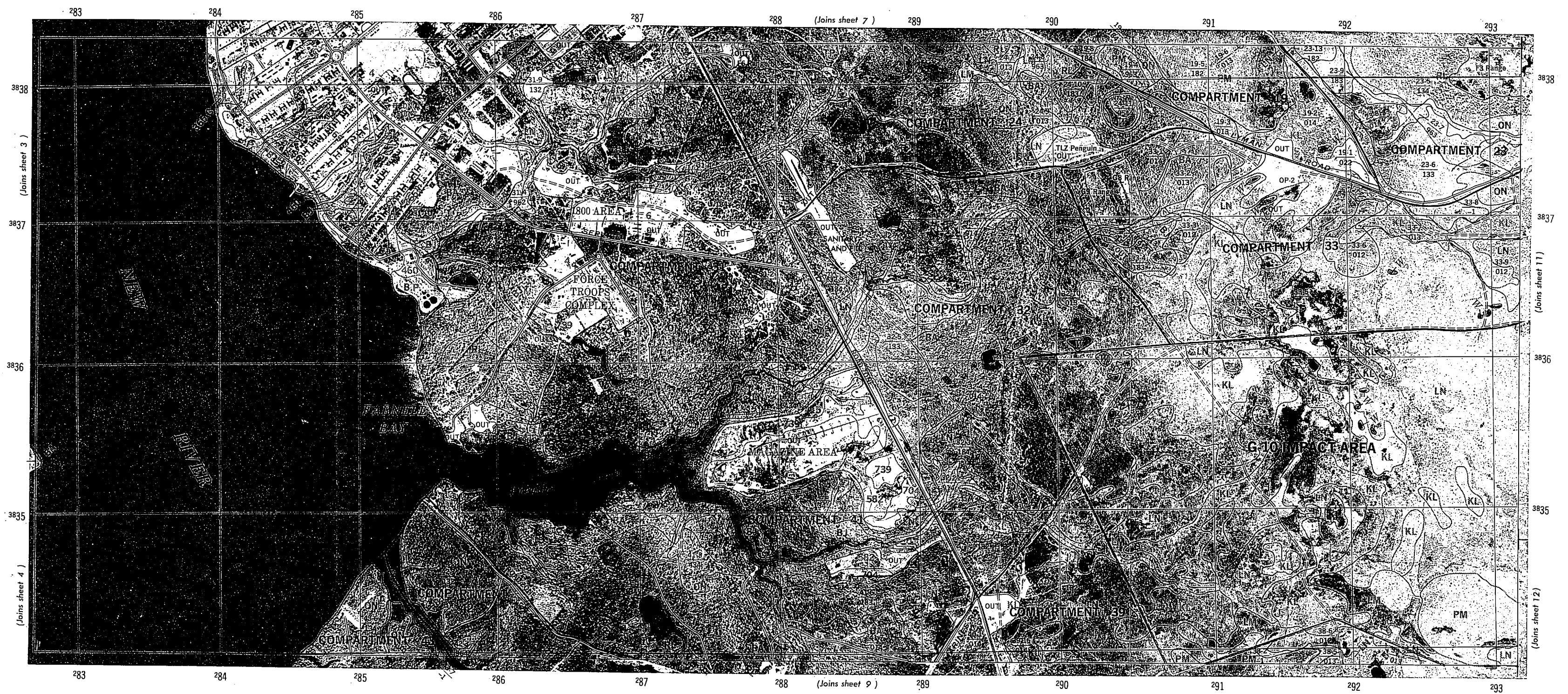
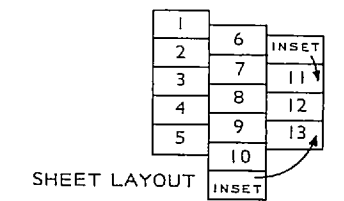

Semicontrolled Mosaic of 1973 Photography  
 Prepared by USDA, Soil Conservation Service  
 Cartographic Unit, Fort Worth, Texas.

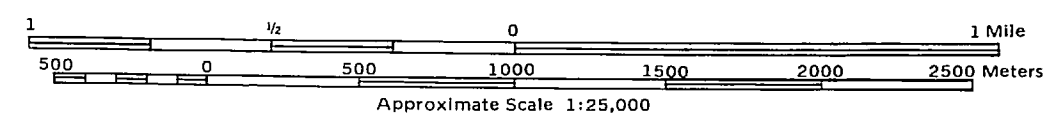





NATURAL RESOURCES CONSERVATION PLAN  
 CAMP LEJEUNE USMC RESERVATION  
 ONSLOW COUNTY, NORTH CAROLINA

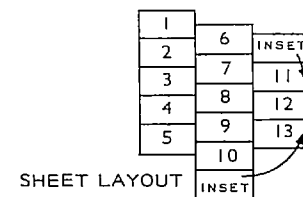

(Joins sheet 8 )

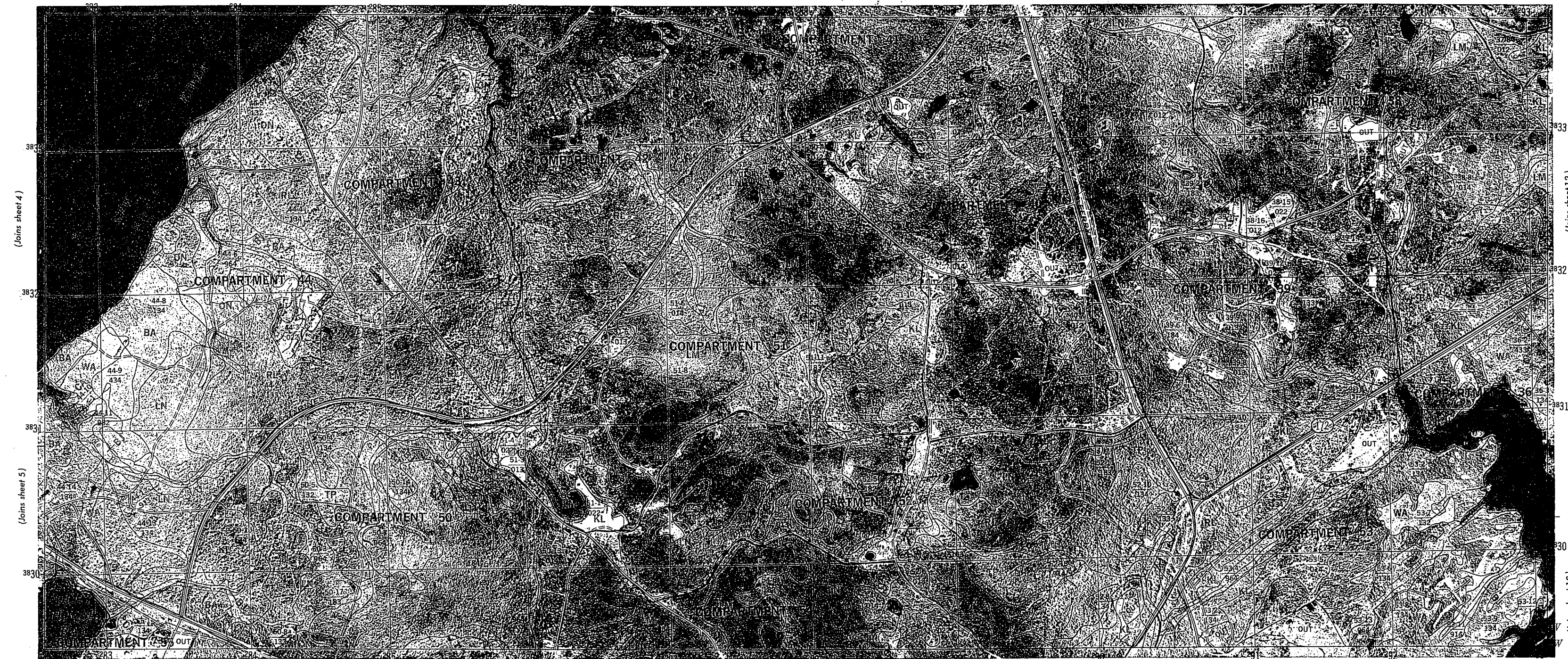

(Joins sheet 4 )

(Joins sheet 5 )

(Joins sheet 12 )

(Joins sheet 13 )

(Joins sheet 10 )

Semicontrolled Mosaic of 1973 Photography  
 Prepared by USDA, Soil Conservation Service  
 Cartographic Unit, Fort Worth, Texas.

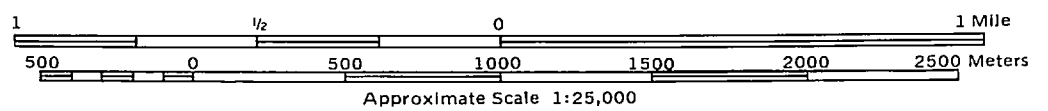

1870

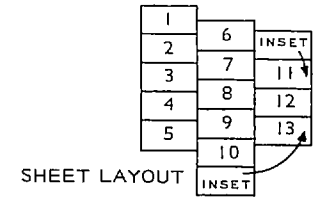

(Joins sheet 9)

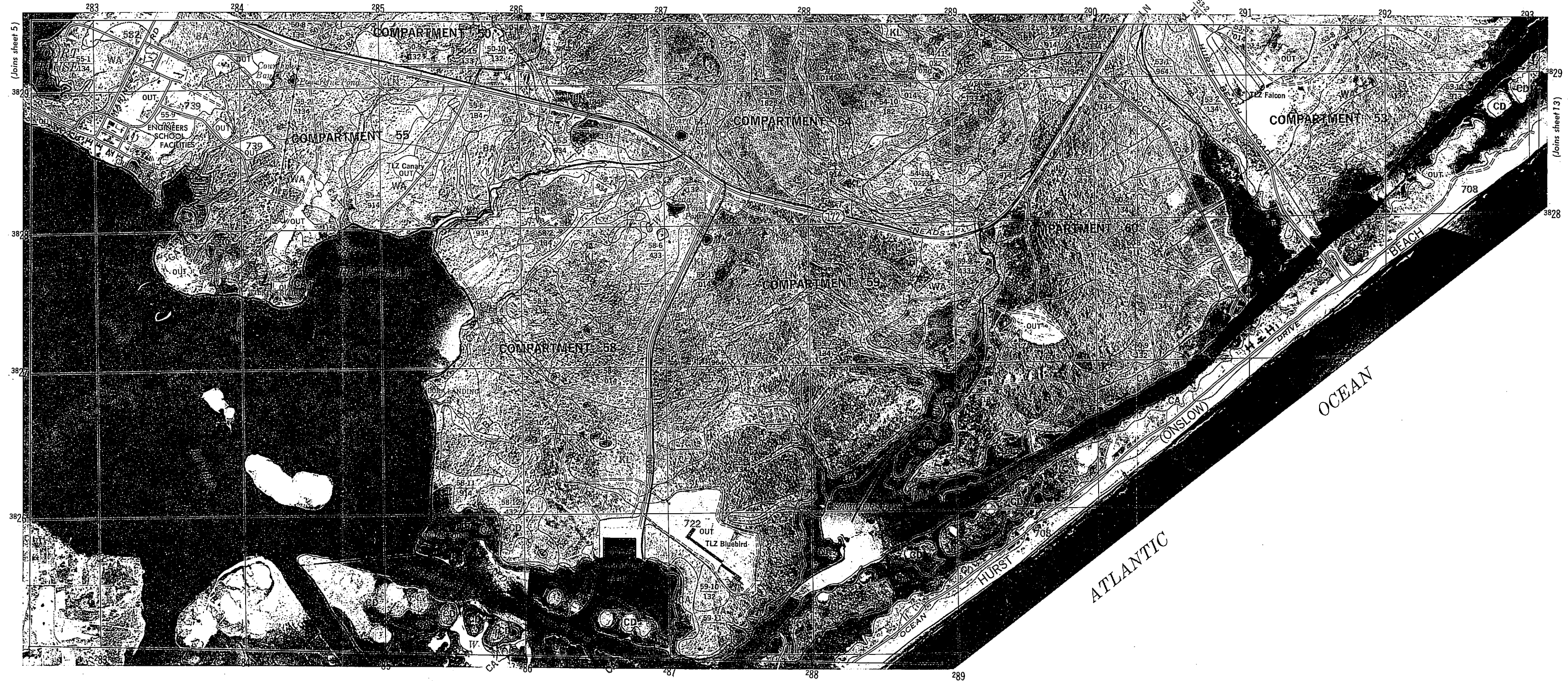

(Joins sheet 5)

(Joins sheet 13)

(Joins inset, sheet 13)

Semiconrolled Mosaic of 1973 Photography  
 Prepared by USDA, Soil Conservation Service  
 Cartographic Unit, Fort Worth, Texas.

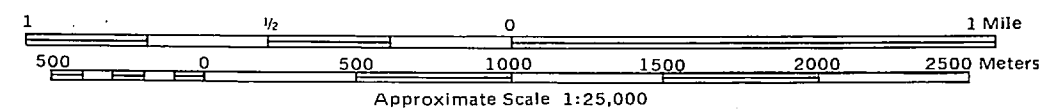



# NATURAL RESOURCES CONSERVATION PLAN CAMP LEJEUNE USMC RESERVATION ONslow COUNTY, NORTH CAROLINA

1	6	INSET
2	7	INSET
3	8	INSET
4	9	INSET
5	10	INSET

SHEET LAYOUT

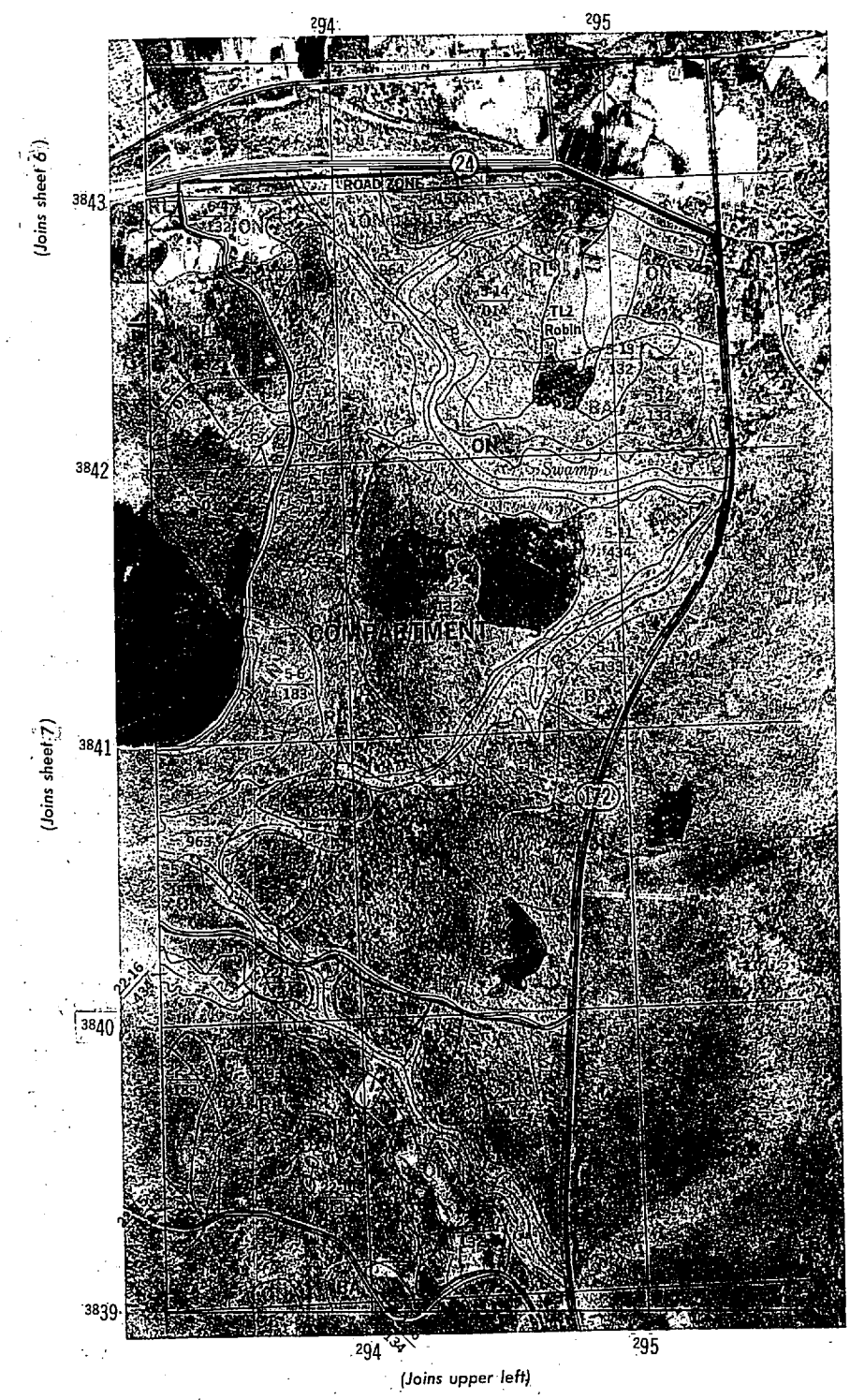

Semiconrolled Mosaic of 1973 Photography  
Prepared by USDA, Soil Conservation Service  
Cartographic Unit, Fort Worth, Texas.

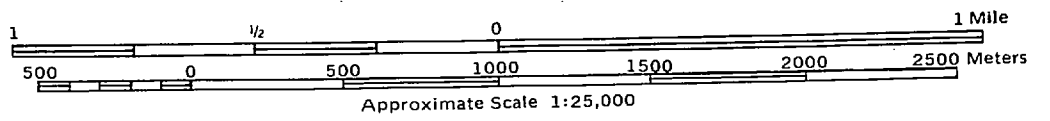

1873

NATURAL RESOURCES CONSERVATION PLAN  
 CAMP LEJEUNE USMC RESERVATION  
 ONSLOW COUNTY, NORTH CAROLINA

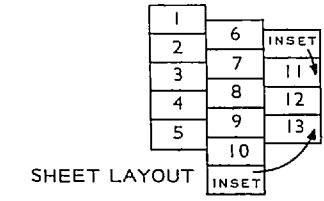

(Joins sheet 11 )

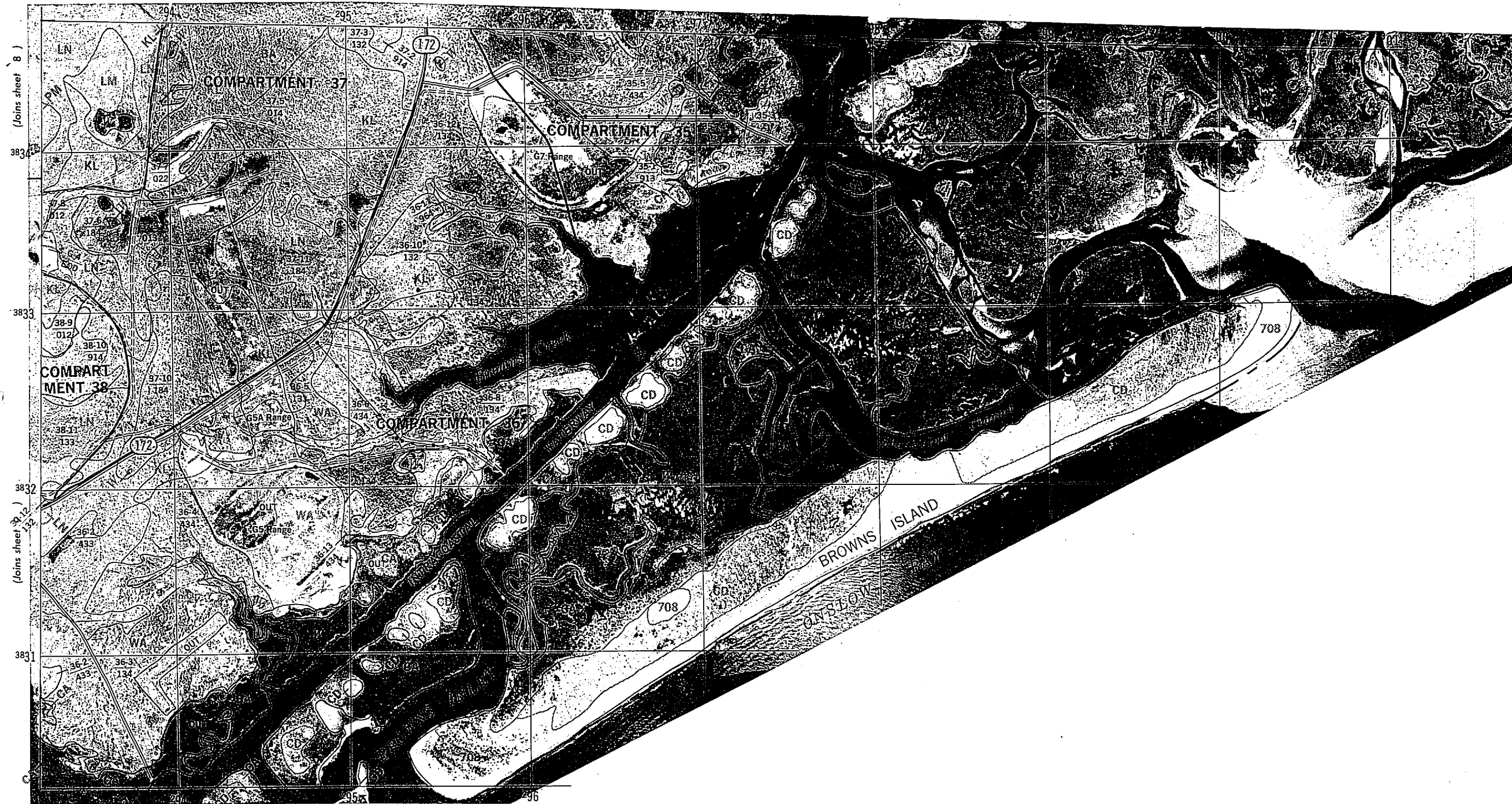

(Joins sheet 13 )

Semiconrolled Mosaic of 1973 Photography  
 Prepared by USDA, Soil Conservation Service  
 Cartographic Unit, Fort Worth, Texas.

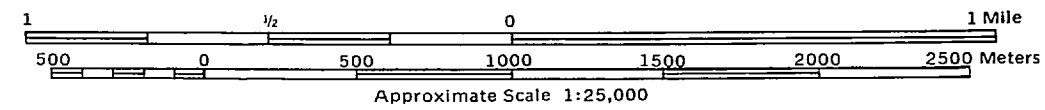



1872

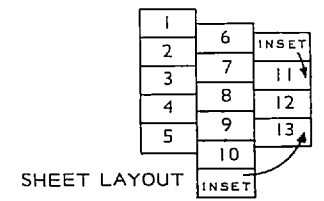

NATURAL RESOURCES CONSERVATION PLAN  
**CAMP LEJEUNE USMC RESERVATION**  
 ONSLOW COUNTY, NORTH CAROLINA

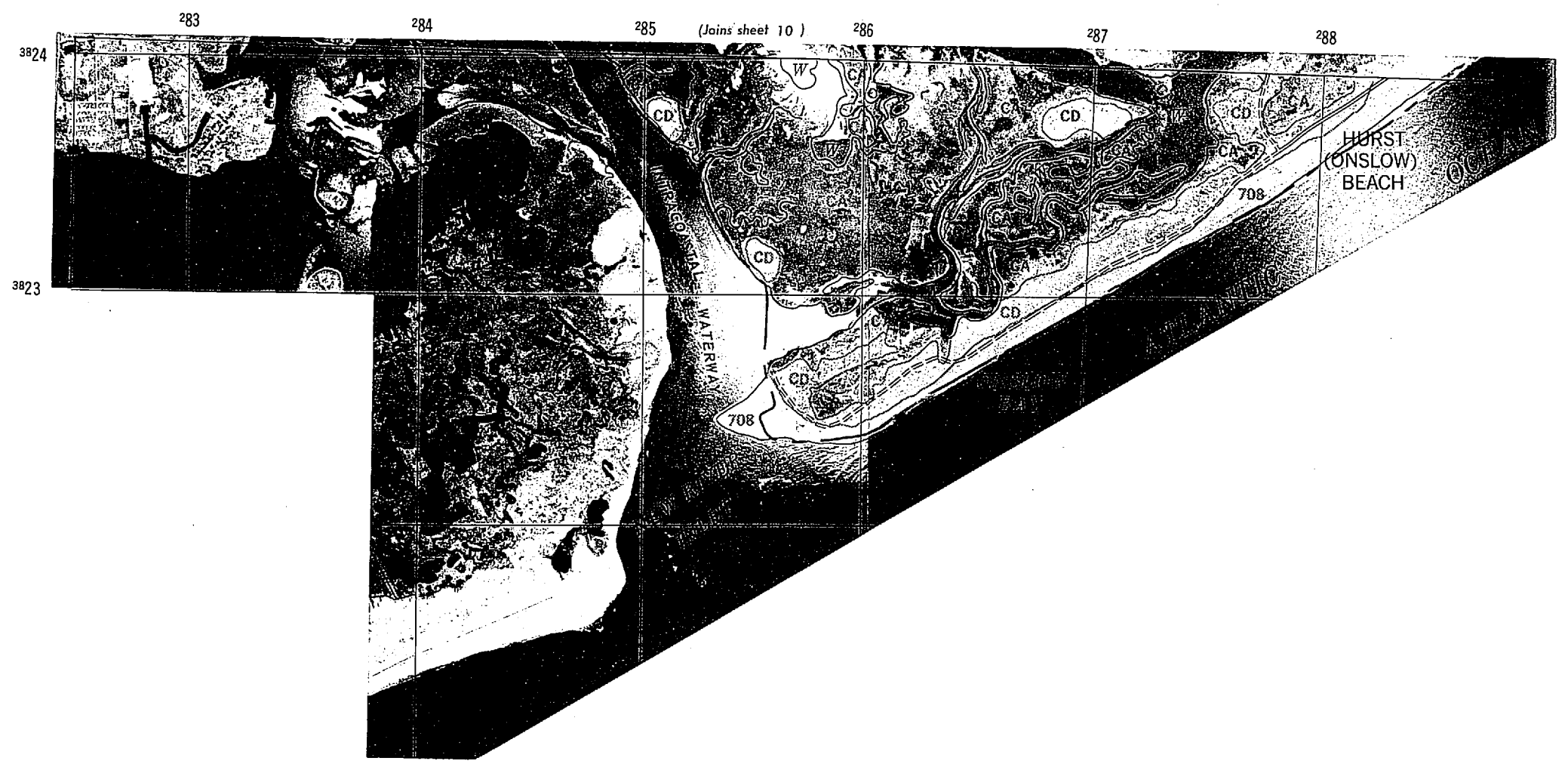
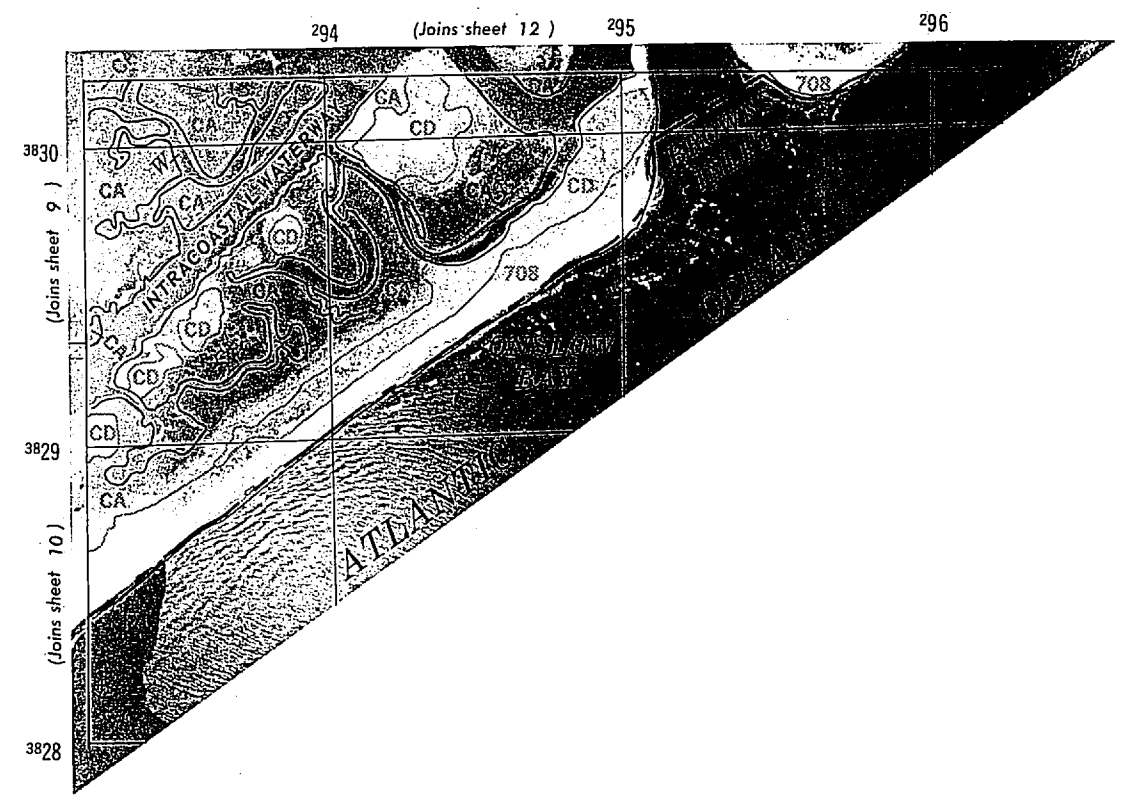



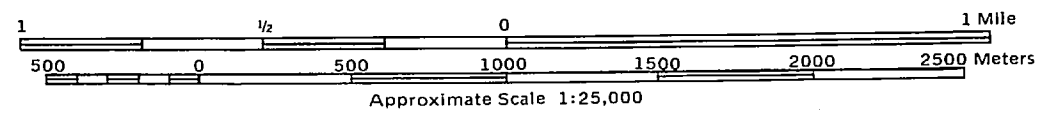







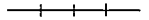

Semiconrolled Mosaic of 1973 Photography  
 Prepared by USDA, Soil Conservation Service  
 Cartographic Unit, Fort Worth, Texas.



1870

OAK GROVE  
 CAMP LEJEUNE USMC OUTLYING FIELD  
 JONES COUNTY, NORTH CAROLINA

L.2 Falcon  
 20 m.

- LEGEND
-  Divided Highway
  -  Good Motor Road
  -  Poor Motor Road
  -  Railroad
  -  Project Boundary
  -  County Line
  -  Power Line
  -  Forest Fire Lookout Station
  -  Cemetery
  -  School
  -  Groins
  -  Borrow Pit
  -  Drainage
  -  Pond or Lake



Semiconrolled Mosaic of 1973 Photography  
 Prepared by USDA, Soil Conservation Service  
 Cartographic Unit, Fort Worth, Texas.

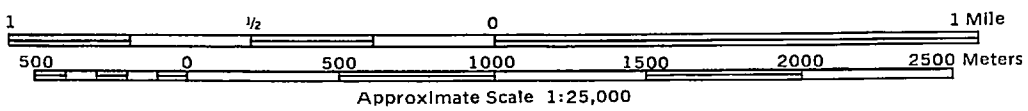

1870

SOIL IDENTIFICATION LEGEND

The following units were mapped in woodlands, firing ranges, marshes and adjacent wet coastal sands. The delineations are generally larger and the composition of the unit is apt to be more variable than for other units in the survey area. Usually there is more than one soil series in each unit. Mapping has been controlled well enough, however, for woodland and wildlife uses of the areas.

Name of Map Unit	
BA	Baymeade soils, 1 to 6 percent slopes
BJ	Bibb and Johnson soils
B.P.	Borrow Pit
CA	Capers soils
CD	Corolla - Duckston complex
KL	Kureb and Lakeland soils, 0 to 6 percent slopes
LN	Leon soils
LM	Lynn Haven and Murville soils
ON	Onslow and Norfolk soils, 0 to 6 percent slopes
PM	Pamlico soils
RL	Rains and Lynchburg soils
TP	Torhunta and Pantego soils
WA	Wando and Seabrook soils, 0 to 6 percent slopes

SOIL IDENTIFICATION LEGEND

The following units were mapped in the areas cleared of forest and put to a variety of uses as: warehouses, barracks, residences, drill and recreational purposes, etc.

Name of Map Unit	
739	Baymeade sand, 1 to 6 percent slopes
853	Bladen fine sandy loam
558B	Craven fine sandy loam, 1 to 4 percent slopes
558C	Craven fine sandy loam, 4 to 8 percent slopes
704	Kureb sand, 0 to 6 percent slopes
582	Leon sand
708	Newhan soils, 2 to 15 percent slopes
365C	Norfolk loamy sand, 6 to 10 percent slopes
415	Onslow fine sandy loam
460	Pactolus loamy sand
870	Torhunta fine sandy loam
6	Urban land
4	Urban land-Onslow soils complex, 0 to 6 percent slopes
722	Wando fine sand
833	Woodington loamy sand

LEGEND

- Divided Highway
- Good Motor Road
- Poor Motor Road
- Railroad
- Project Boundary
- County Line
- Power Line
- Forest Fire Lookout Station
- Cemetery
- School
- Groins
- Borrow Pit
- Drainage
- Pond or Lake

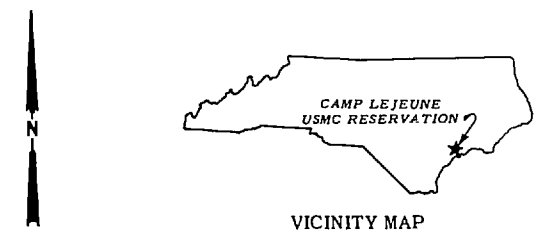
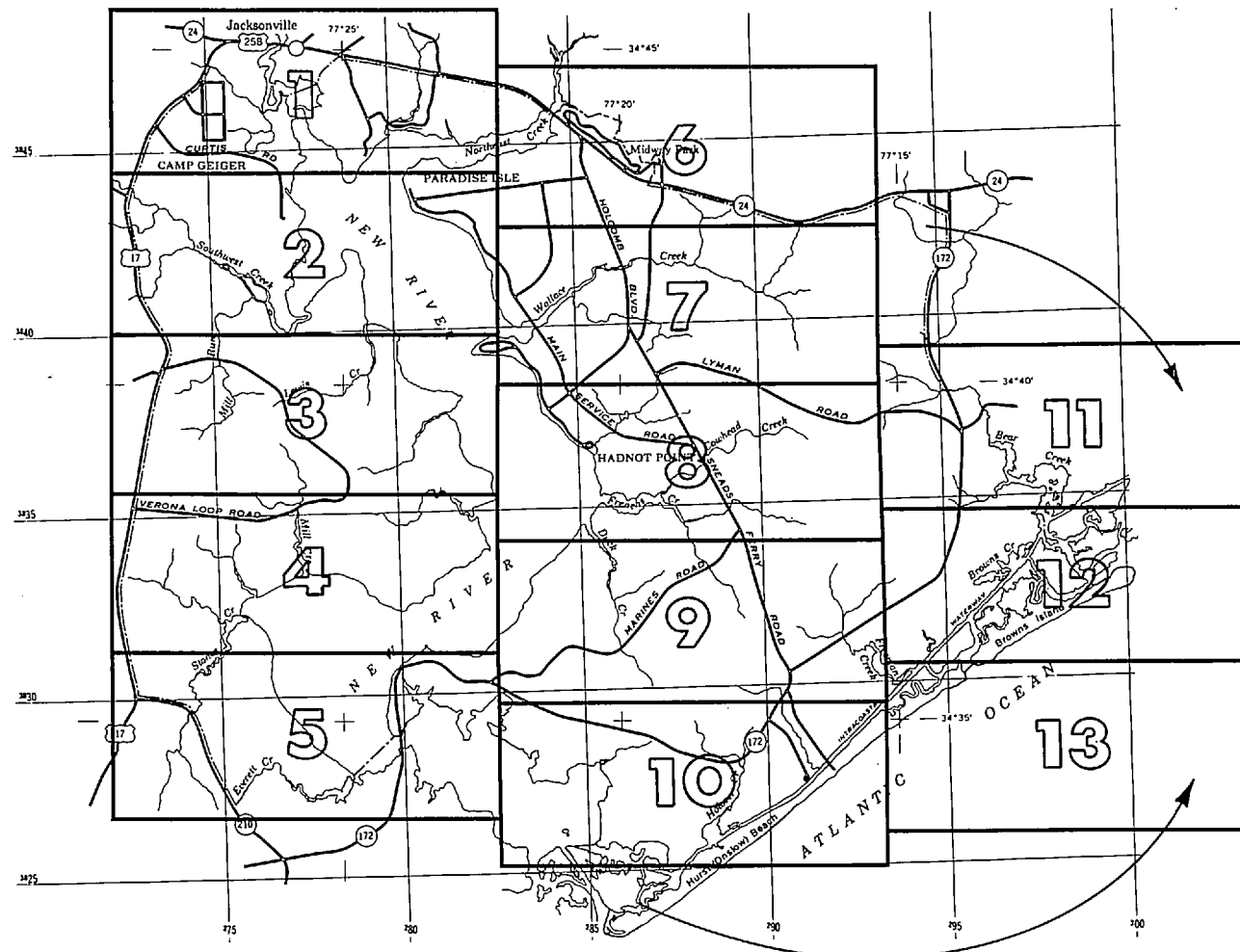

**CAMP LEJEUNE  
USMC RESERVATION  
ONSLOW COUNTY, NORTH CAROLINA**



1  
2  
3  
4  
5  
6  
7  
8  
9  
10  
11  
12  
13  
14  
15  
16  
17  
18  
19  
20  
21  
22  
23  
24  
25  
26  
27  
28  
29  
30  
31  
32  
33  
34  
35  
36  
37  
38  
39  
40  
41  
42  
43  
44  
45  
46  
47  
48  
49  
50  
51  
52  
53  
54  
55  
56  
57  
58  
59  
60  
61  
62  
63  
64  
65  
66  
67  
68  
69  
70  
71  
72  
73  
74  
75  
76  
77  
78  
79  
80  
81  
82  
83  
84  
85  
86  
87  
88  
89  
90  
91  
92  
93  
94  
95  
96  
97  
98  
99  
100





1870

# NATURAL RESOURCES CONSERVATION PLAN CAMP LEJEUNE USMC RESERVATION ONSLOW COUNTY, NORTH CAROLINA

1	6	INSET
2	7	11
3	8	12
4	9	13
5	10	
SHEET LAYOUT		INSET

(Joins sheet 1 )



(Joins sheet 3 )

Semicontrolled Mosaic of 1973 Photography  
Prepared by USDA, Soil Conservation Service  
Cartographic Unit, Fort Worth, Texas.

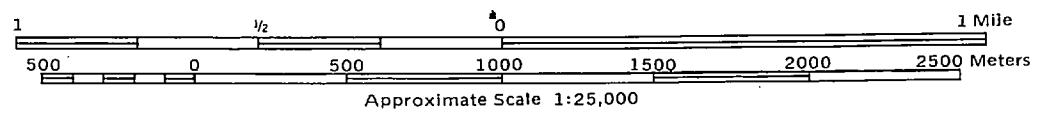

1880

# NATURAL RESOURCES CONSERVATION PLAN CAMP LEJEUNE USMC RESERVATION ONSLOW COUNTY, NORTH CAROLINA

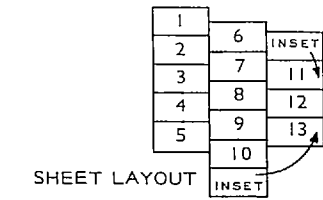

(Joins sheet 2.)

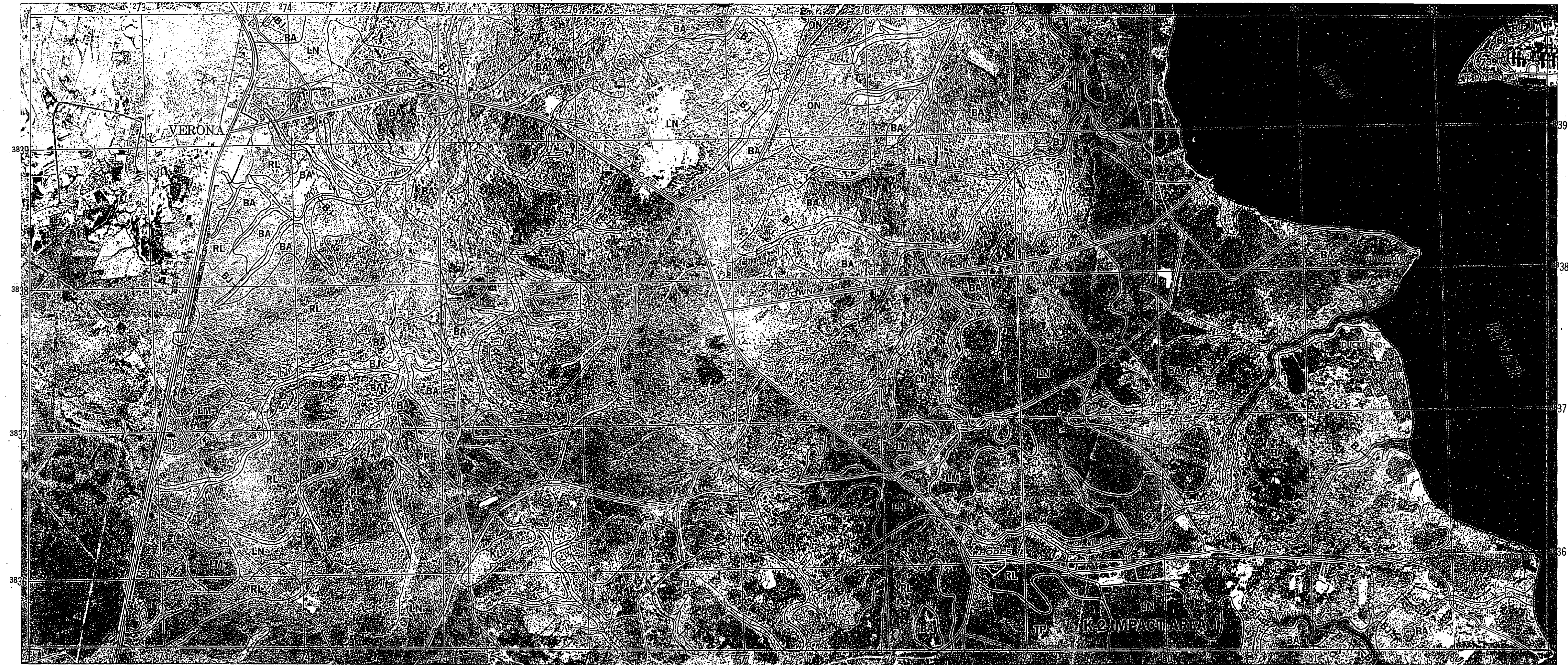

(Joins sheet 7.)

(Joins sheet 8.)

(Joins sheet 4.)

Semicontrolled Mosaic of 1973 Photography  
Prepared by USDA, Soil Conservation Service  
Cartographic Unit, Fort Worth, Texas.

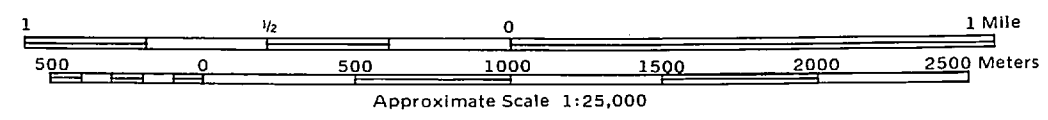

1870  
1871  
1872  
1873  
1874  
1875  
1876  
1877  
1878  
1879  
1880  
1881  
1882  
1883  
1884  
1885  
1886  
1887  
1888  
1889  
1890  
1891  
1892  
1893  
1894  
1895  
1896  
1897  
1898  
1899  
1900

# NATURAL RESOURCES CONSERVATION PLAN CAMP LEJEUNE USMC RESERVATION ONslow COUNTY, NORTH CAROLINA

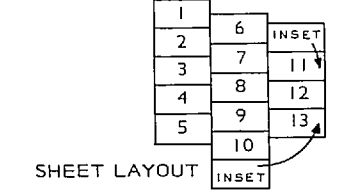

(Joins sheet 3 )

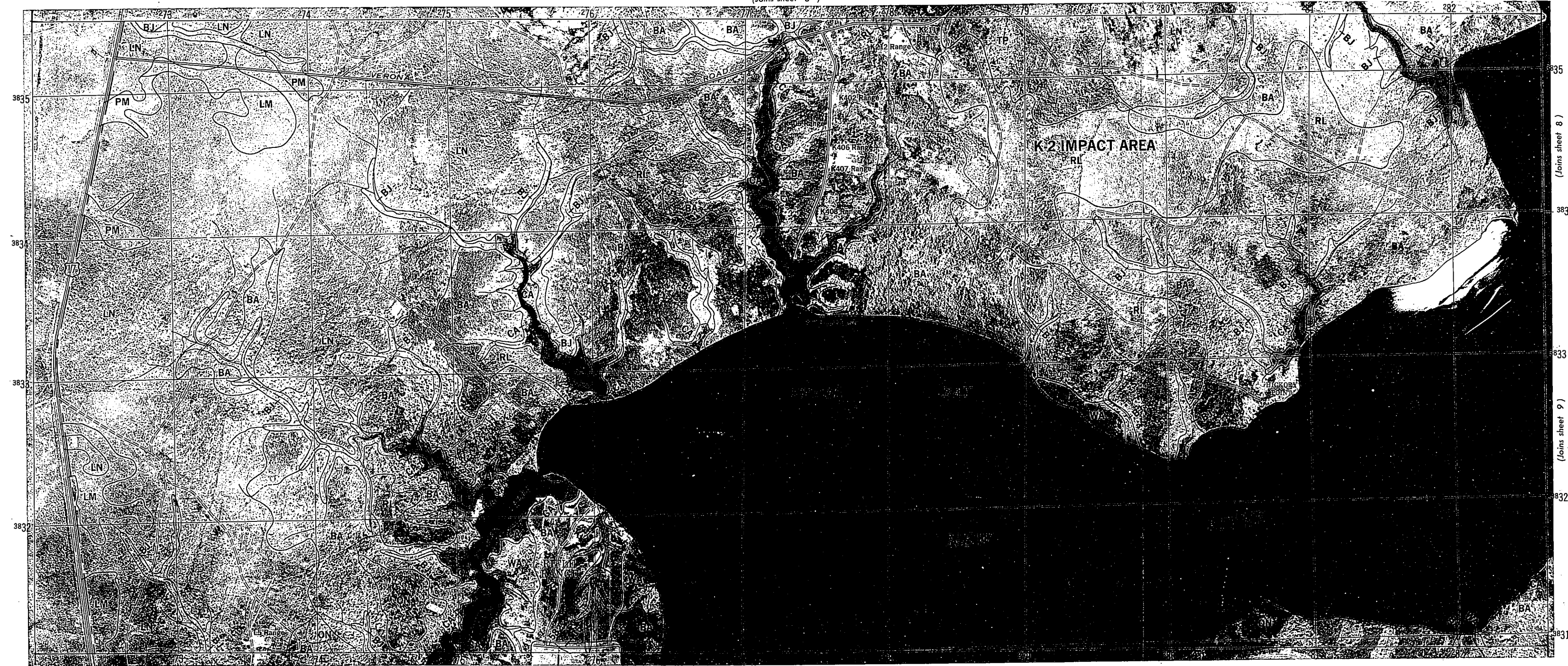

(Joins sheet 8 )

(Joins sheet 9 )

(Joins sheet 5 )

Semiconrolled Mosaic of 1973 Photography  
Prepared by USDA, Soil Conservation Service  
Cartographic Unit, Fort Worth, Texas.

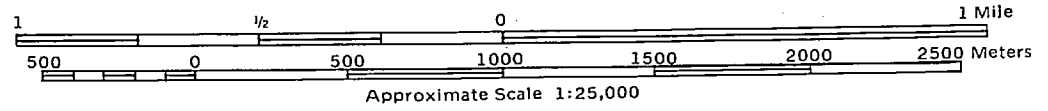

1875

# NATURAL RESOURCES CONSERVATION PLAN CAMP LEJEUNE USMC RESERVATION ONslow COUNTY, NORTH CAROLINA

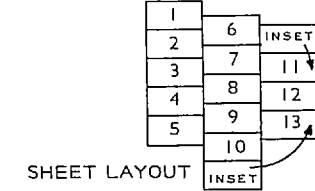

(Joins sheet 4)

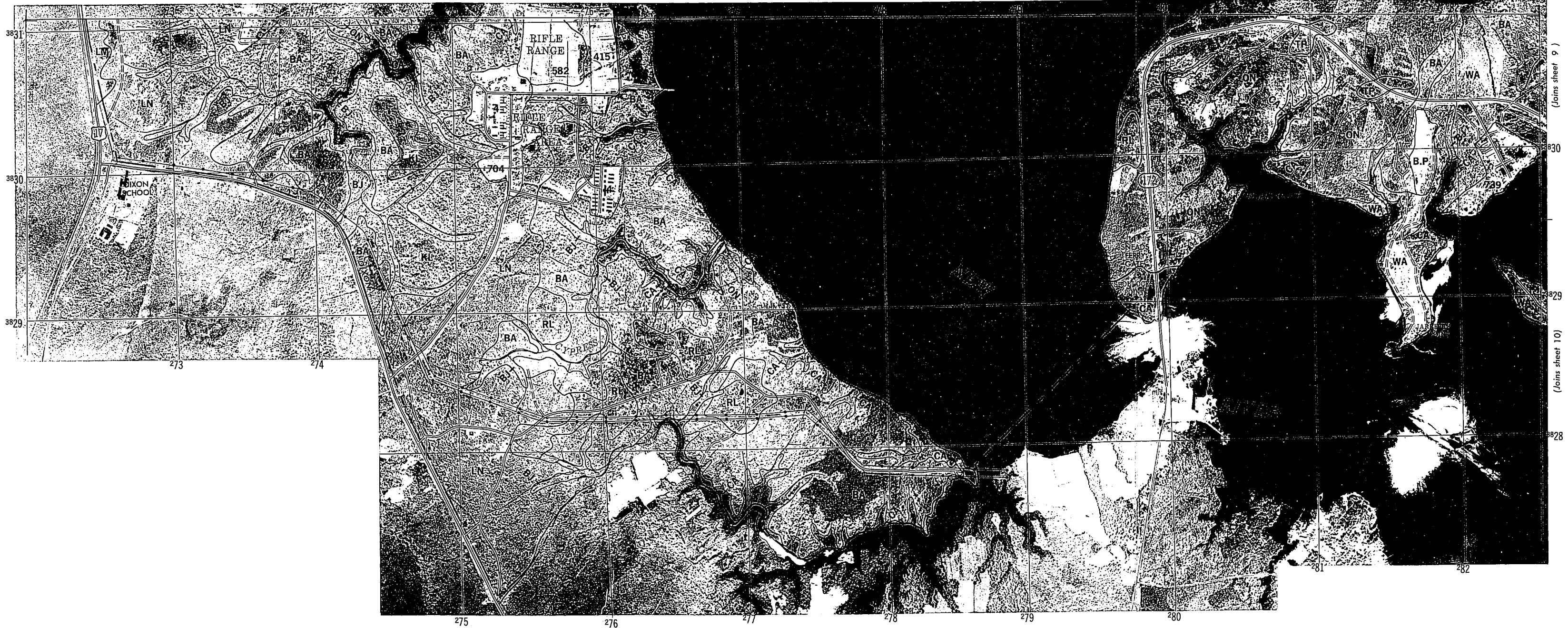

Semiconrolled Mosaic of 1973 Photography  
Prepared by USDA, Soil Conservation Service  
Cartographic Unit, Fort Worth, Texas.

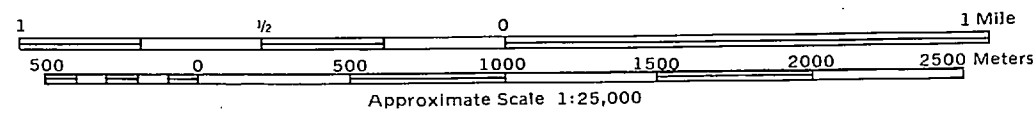





NATURAL RESOURCES CONSERVATION PLAN  
**CAMP LEJEUNE USMC RESERVATION**  
 ONSLOW COUNTY, NORTH CAROLINA

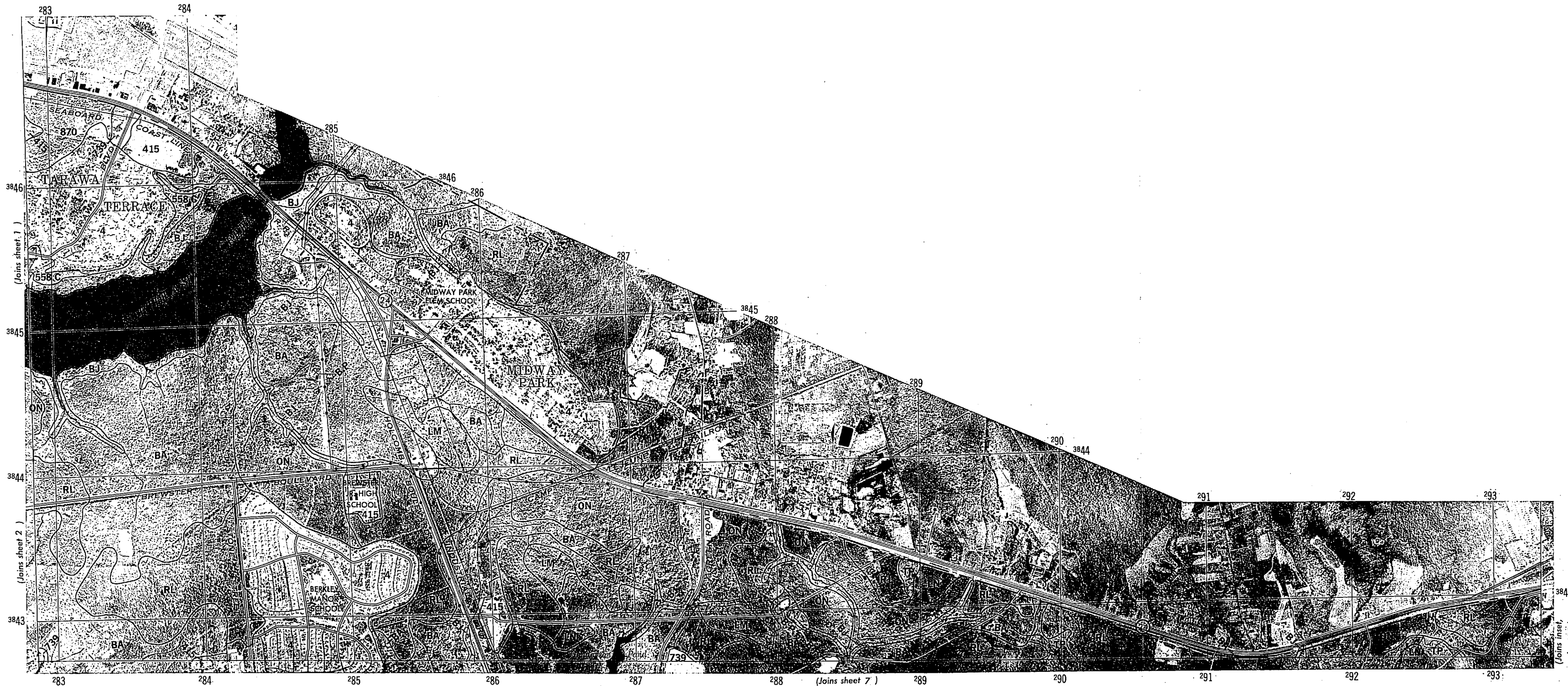
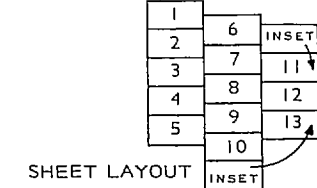

Semiconrolled Mosaic of 1973 Photography  
 Prepared by USDA, Soil Conservation Service  
 Cartographic Unit, Fort Worth, Texas.

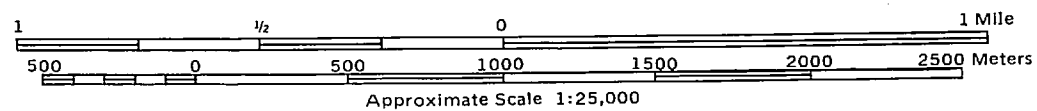

1870

NATURAL RESOURCES CONSERVATION PLAN  
**CAMP LEJEUNE USMC RESERVATION**  
 ONSLOW COUNTY, NORTH CAROLINA

1	6	INSET
2	7	11
3	8	12
4	9	13
5	10	
		INSET

SHEET LAYOUT

(Joins sheet 6 )

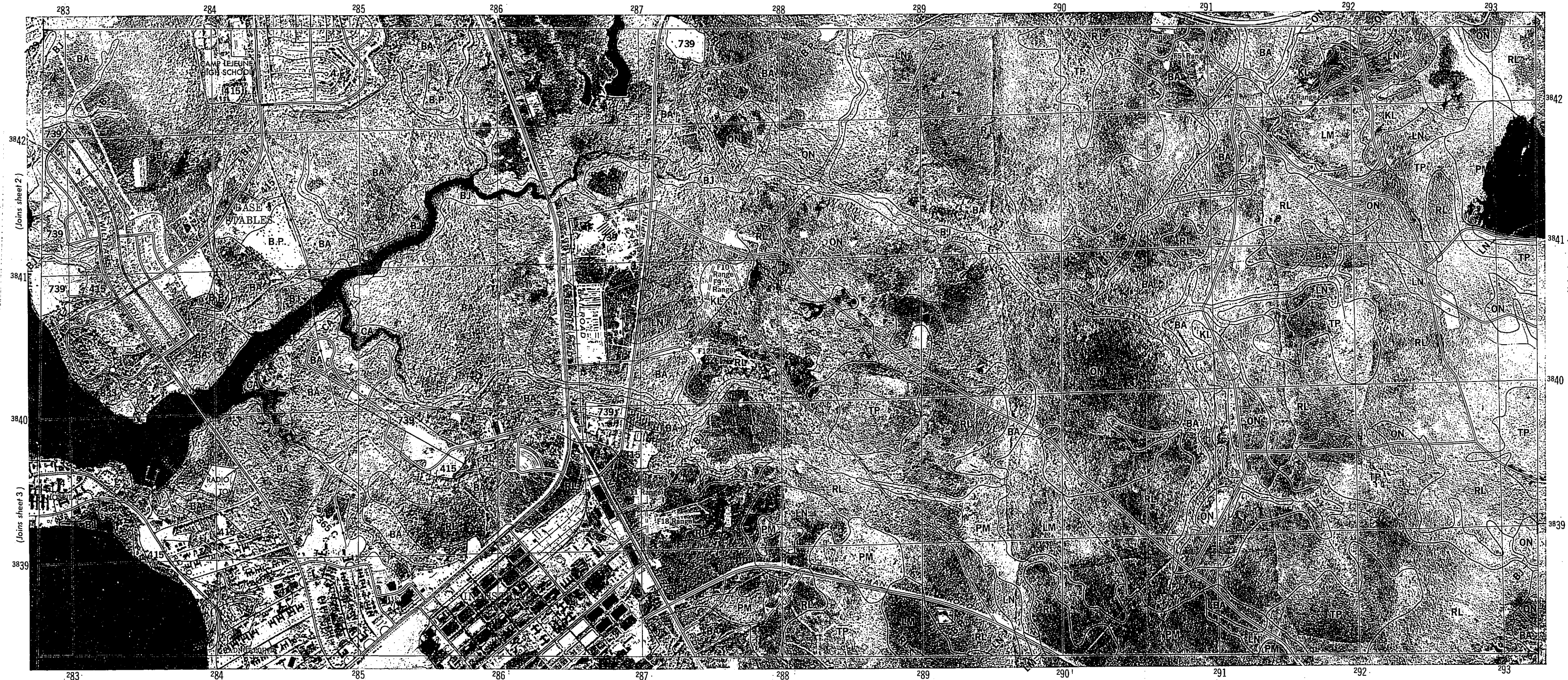

(Joins sheet 2)

(Joins sheet 3)

(Joins inset, sheet 11)

(Joins sheet 11)

(Joins sheet 8 )

Semicontrolled Mosaic of 1973 Photography  
 Prepared by USDA, Soil Conservation Service  
 Cartographic Unit, Fort Worth, Texas.

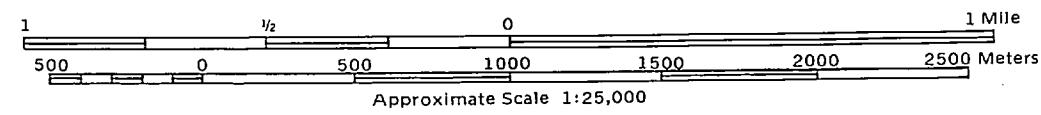

1870

NATURAL RESOURCES CONSERVATION PLAN  
 CAMP LEJEUNE USMC RESERVATION  
 ONSLOW COUNTY, NORTH CAROLINA

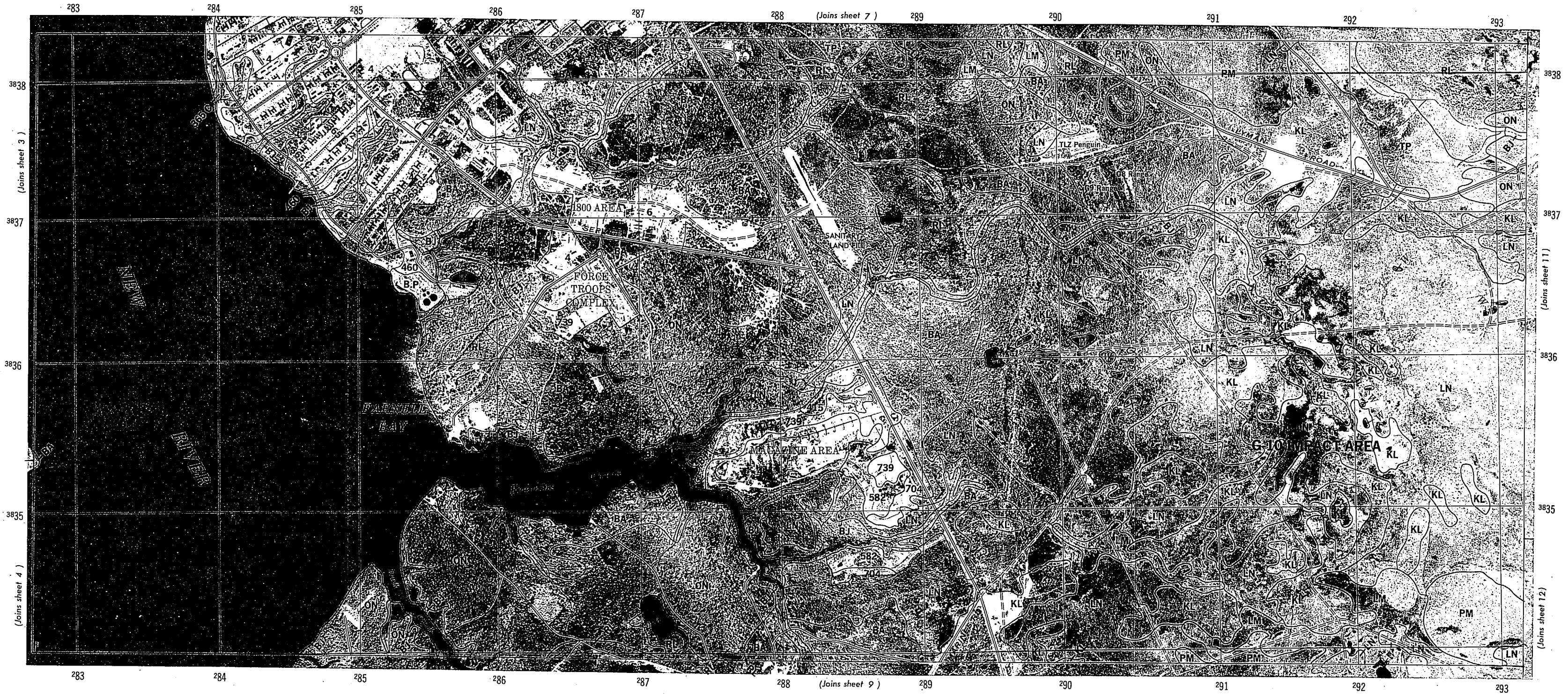
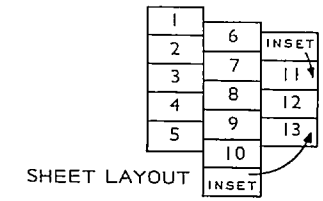

Semiconrolled Mosaic of 1973 Photography  
 Prepared by USDA, Soil Conservation Service  
 Cartographic Unit, Fort Worth, Texas.

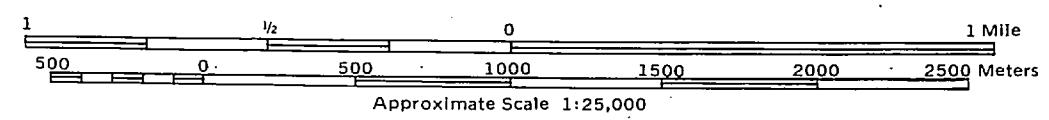

1870

# NATURAL RESOURCES CONSERVATION PLAN CAMP LEJEUNE USMC RESERVATION ON SLOW COUNTY, NORTH CAROLINA

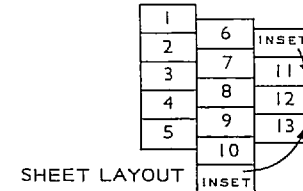

(Joins sheet 8 )

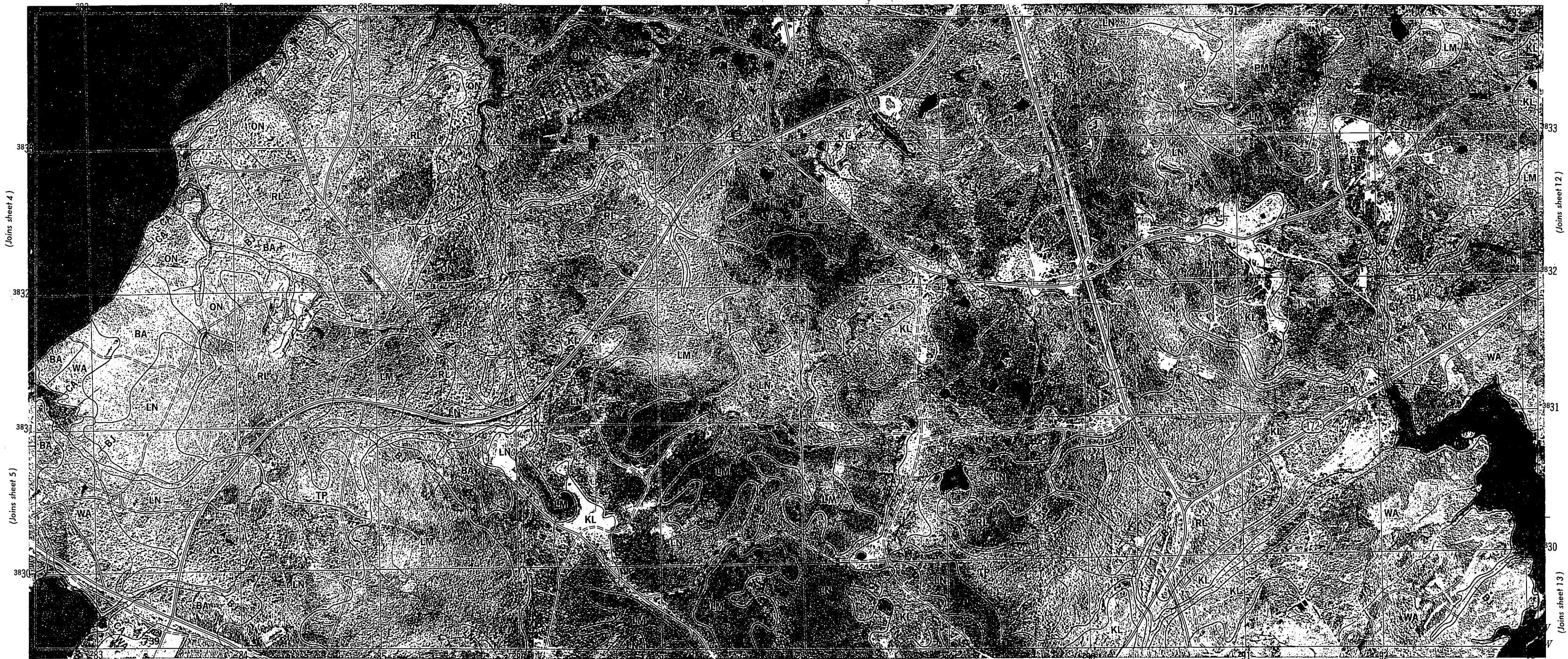

(Joins sheet 4 )

(Joins sheet 5 )

(Joins sheet 12 )

(Joins sheet 13 )

(Joins sheet 10 )

Semiconrolled Mosaic of 1973 Photography  
Prepared by USDA, Soil Conservation Service  
Cartographic Unit, Fort Worth, Texas.

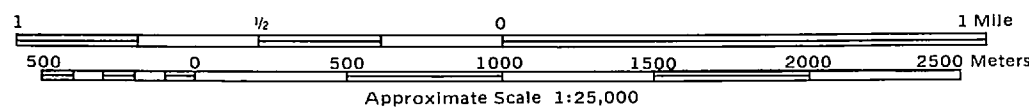



Handwritten text, possibly a signature or name, written vertically on the right edge of the page.

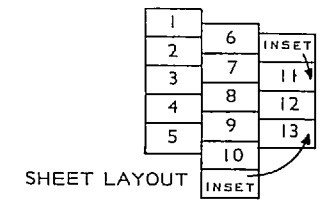

(Joins sheet 9)

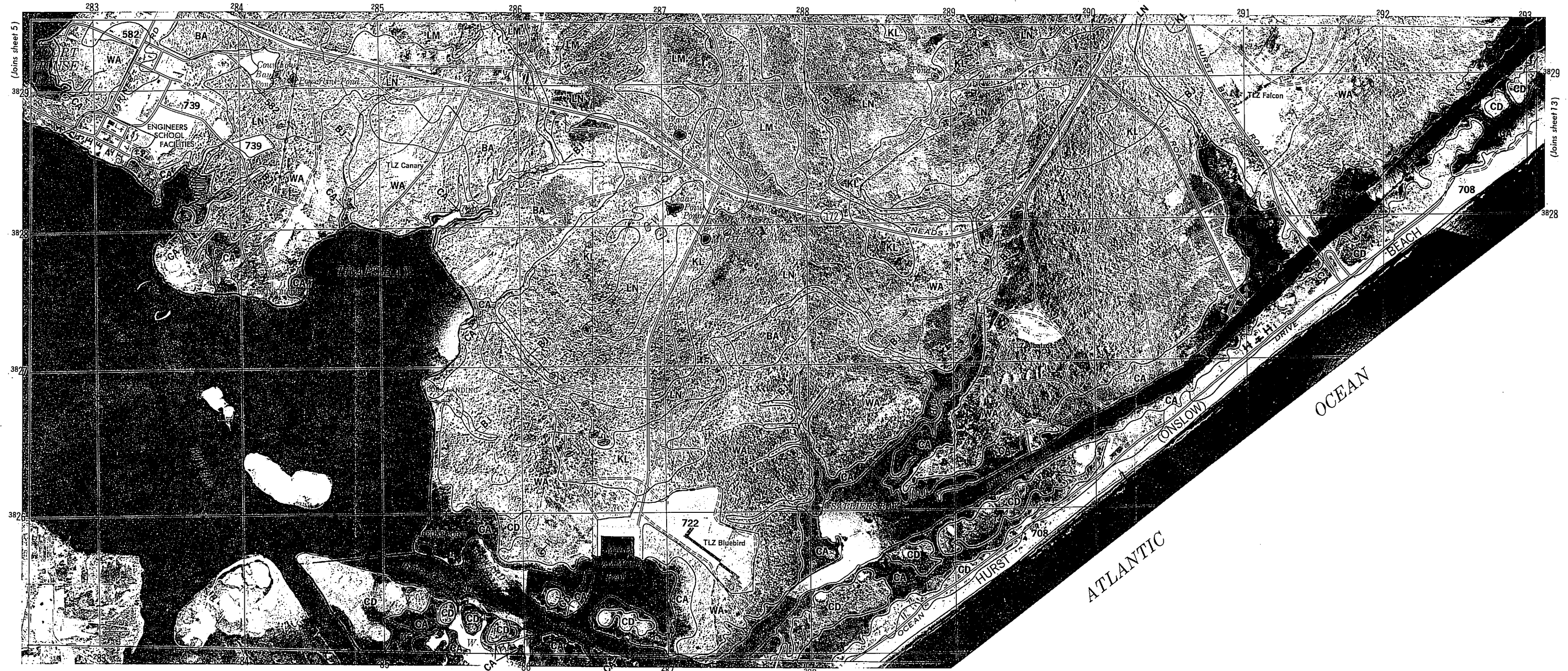

(Joins sheet 5)

(Joins sheet 13)

(Joins inset, sheet 13)

Semiconrolled Mosaic of 1973 Photography  
 Prepared by USDA, Soil Conservation Service  
 Cartographic Unit, Fort Worth, Texas.

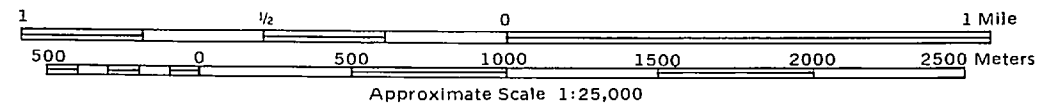

1870

# NATURAL RESOURCES CONSERVATION PLAN CAMP LEJEUNE USMC RESERVATION ONSLOW COUNTY, NORTH CAROLINA

1	6	INSET
2	7	11
3	8	12
4	9	13
5	10	INSET

SHEET LAYOUT

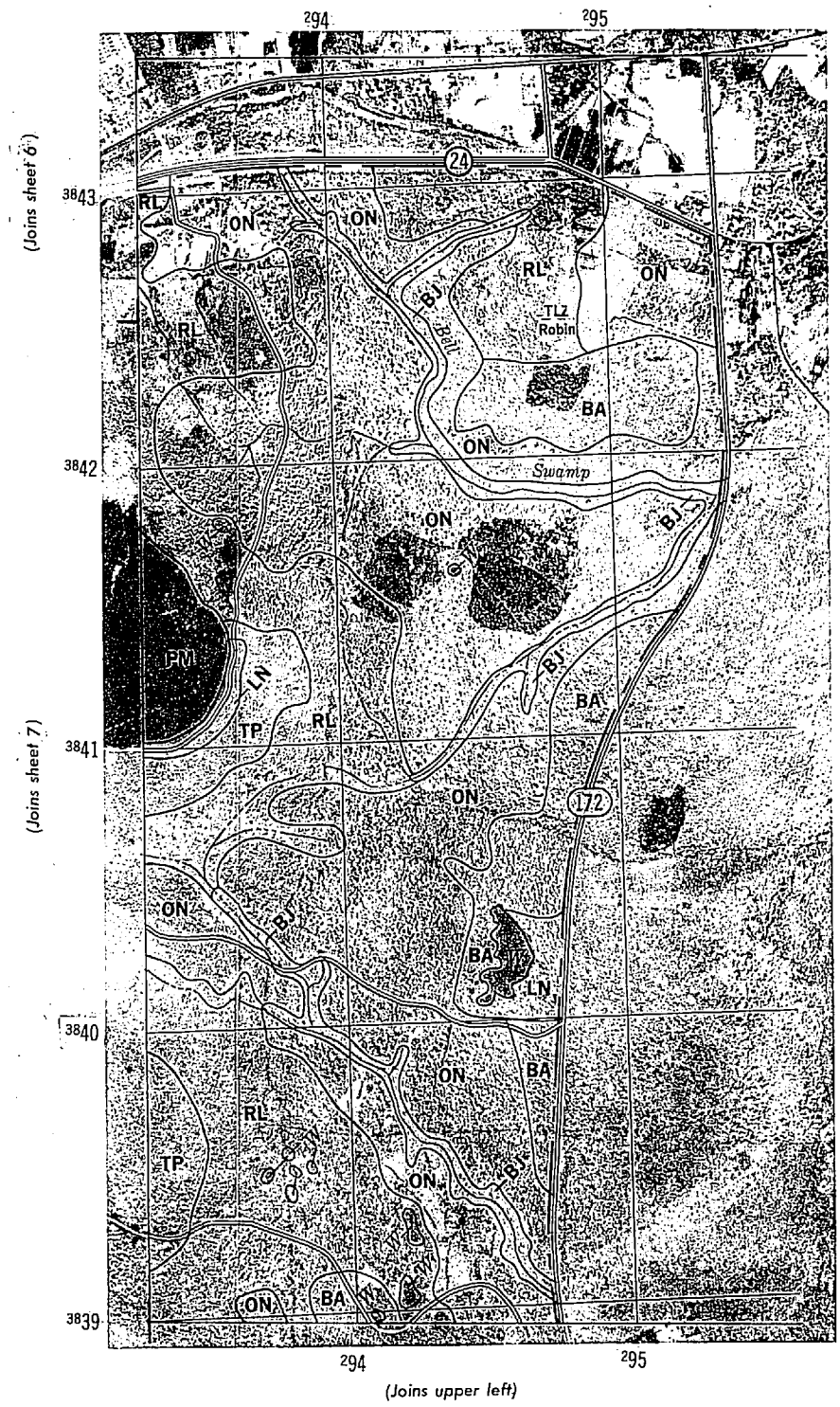
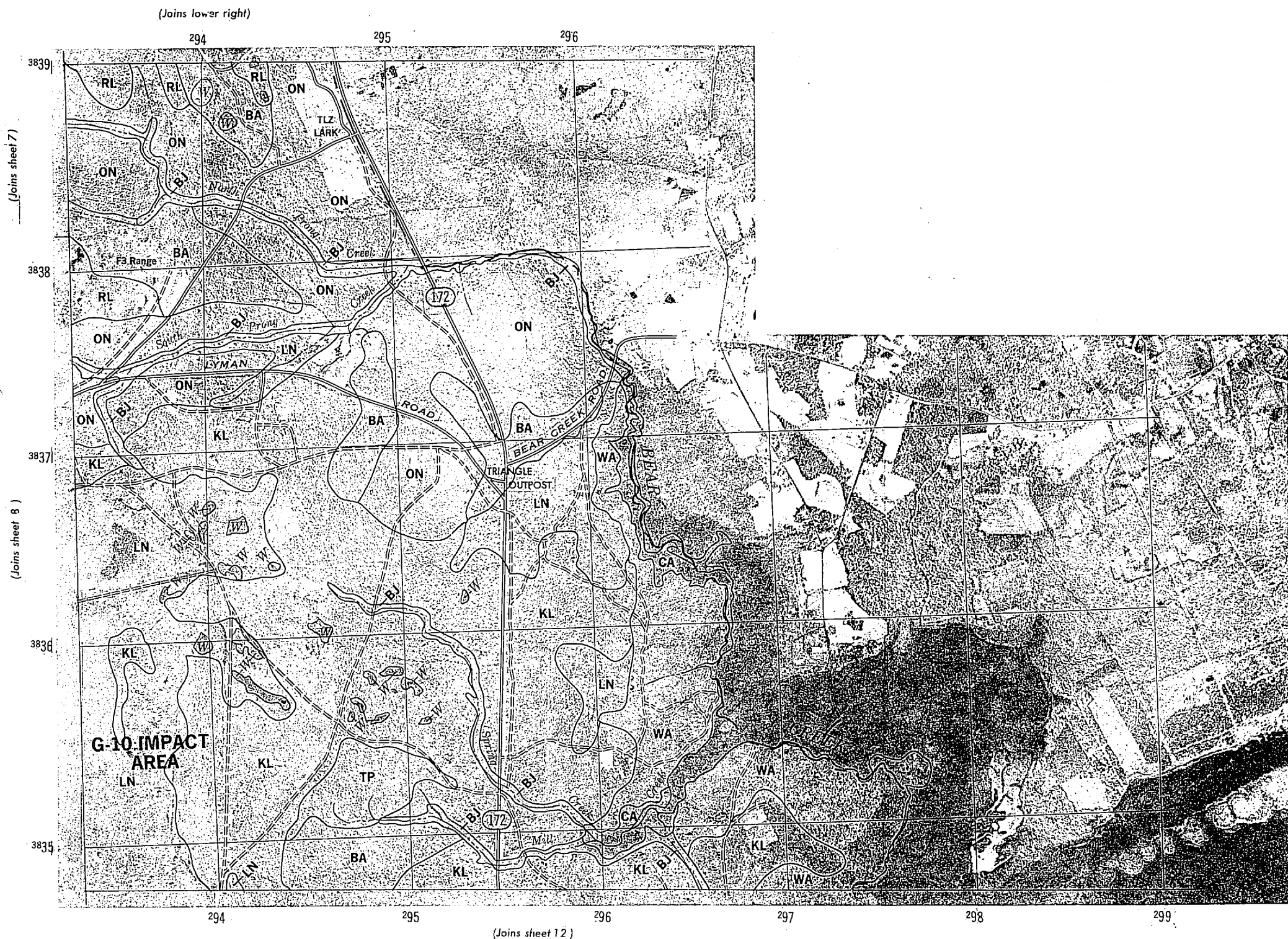

Semicontrolled Mosaic of 1973 Photography  
Prepared by USDA, Soil Conservation Service  
Cartographic Unit, Fort Worth, Texas.

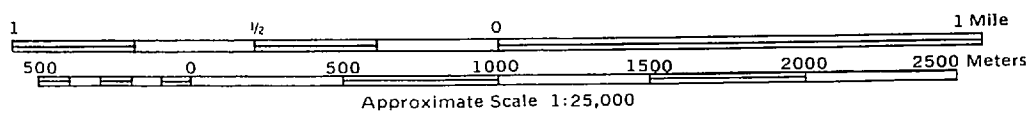

1870

# NATURAL RESOURCES CONSERVATION PLAN CAMP LEJEUNE USMC RESERVATION ONSLOW COUNTY, NORTH CAROLINA

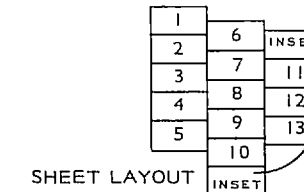

(Joins sheet 11 )

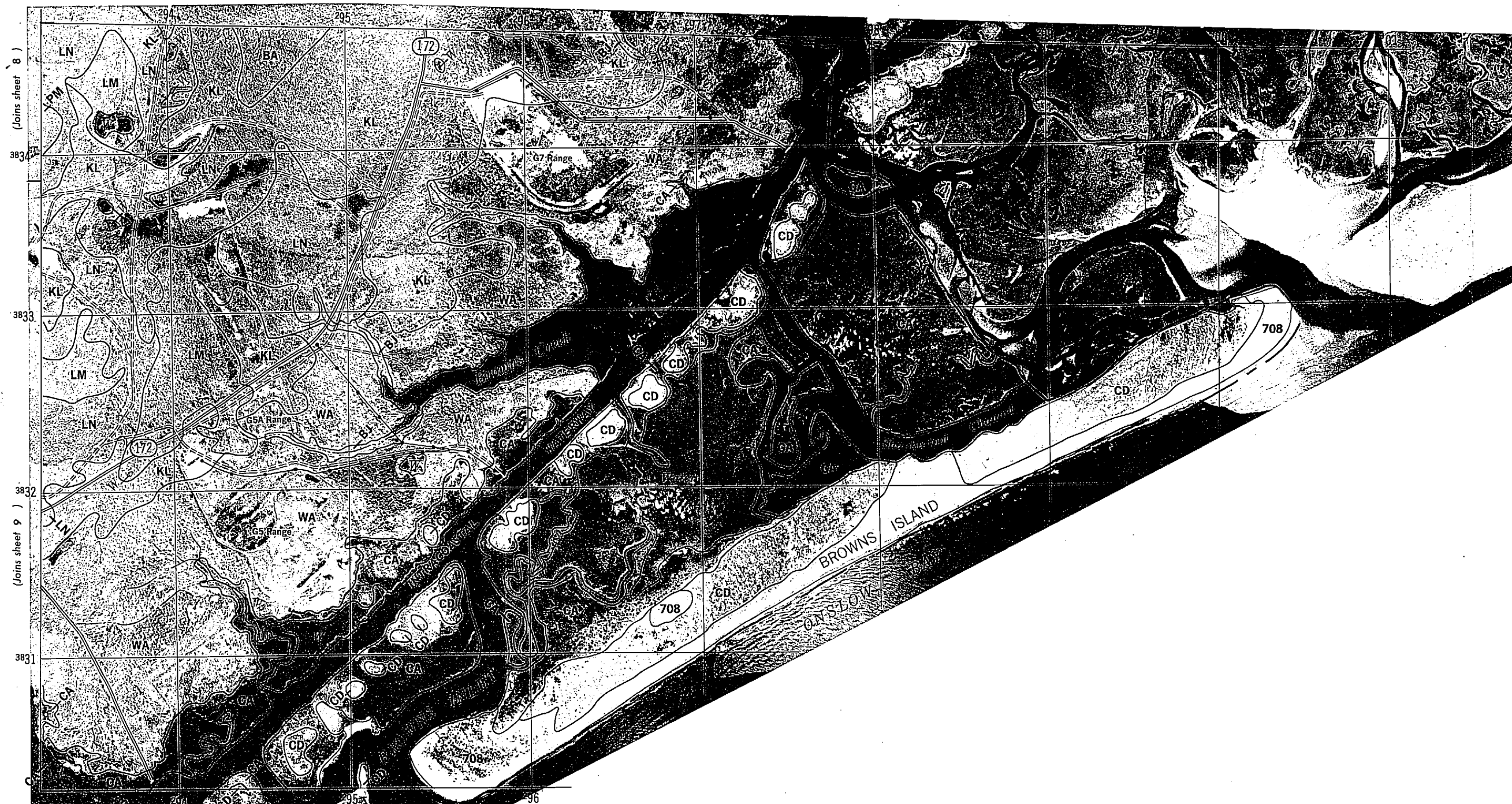

(Joins sheet 8 )

(Joins sheet 9 )

(Joins sheet 13 )

Semiconrolled Mosaic of 1973 Photography  
Prepared by USDA, Soil Conservation Service  
Cartographic Unit, Fort Worth, Texas.

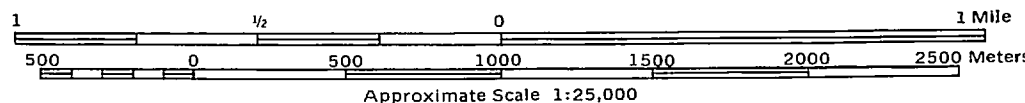

1875  
1876  
1877  
1878  
1879  
1880  
1881  
1882  
1883  
1884  
1885  
1886  
1887  
1888  
1889  
1890  
1891  
1892  
1893  
1894  
1895  
1896  
1897  
1898  
1899  
1900

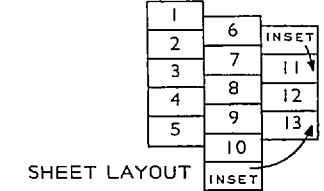

NATURAL RESOURCES CONSERVATION PLAN  
**CAMP LEJEUNE USMC RESERVATION**  
 ONSLOW COUNTY, NORTH CAROLINA

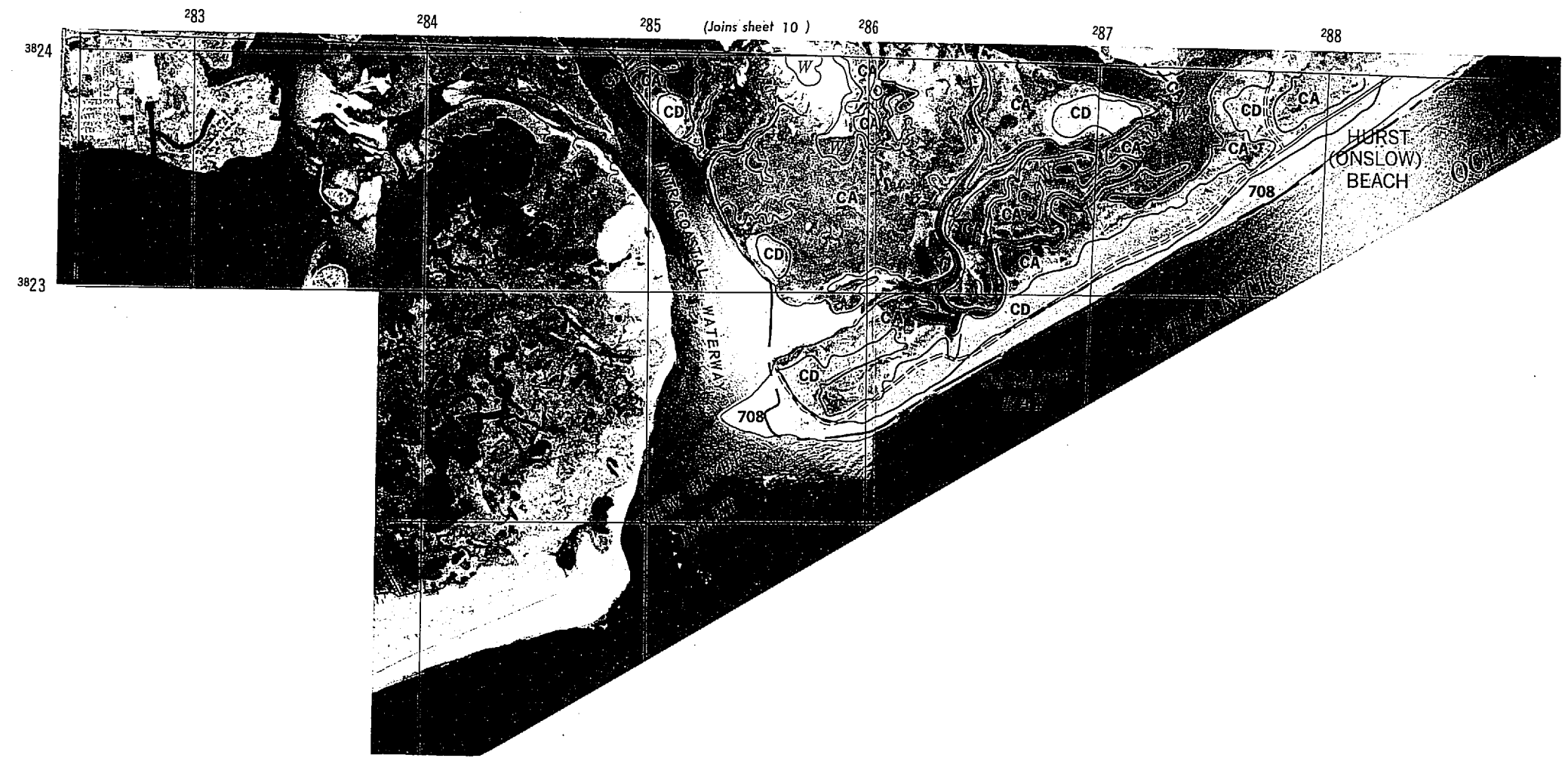
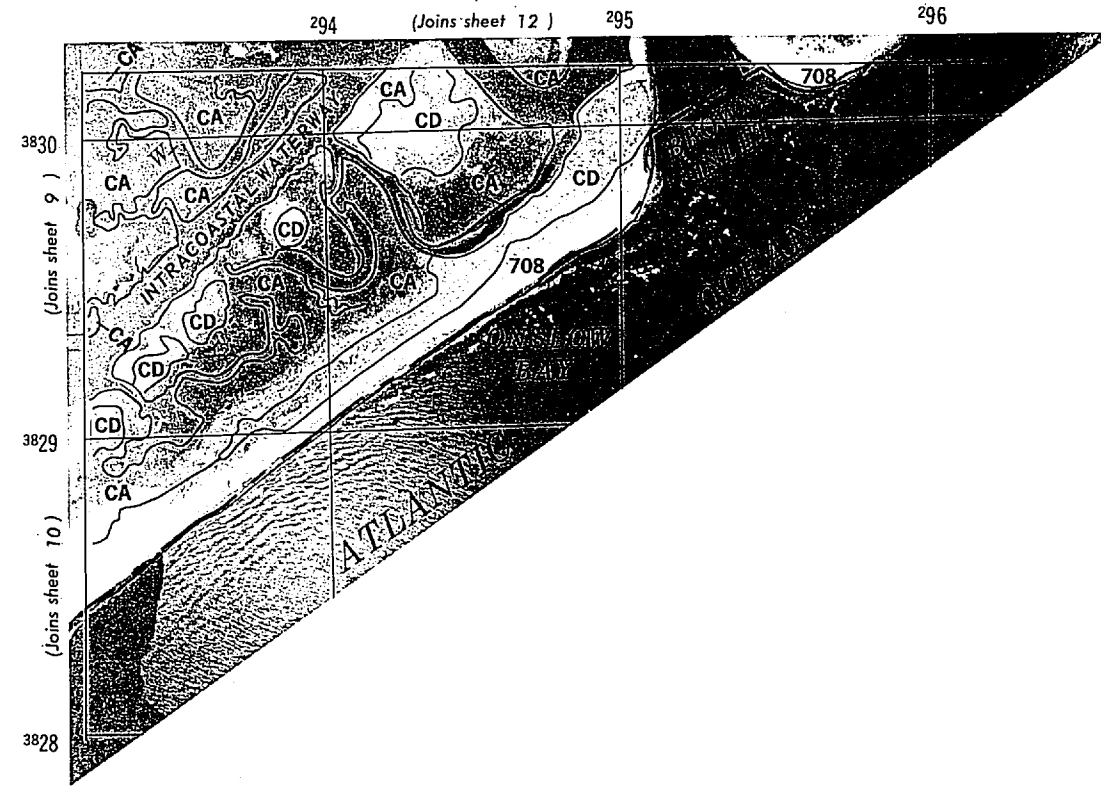

Semicontrolled Mosaic of 1973 Photography  
 Prepared by USDA, Soil Conservation Service  
 Cartographic Unit, Fort Worth, Texas.

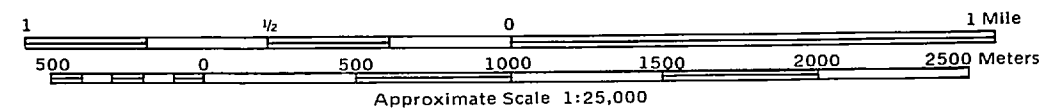



1875

1875

1875















1875

**OAK GROVE**  
**CAMP LEJEUNE USMC OUTLYING FIELD**  
 JONES COUNTY, NORTH CAROLINA

**SOIL IDENTIFICATION LEGEND**

811	Bibb soils, frequently flooded
B.P.	Borrow Pits
558B	Craven fine sandy loam, 1 to 4 percent slopes
402	Johns sandy loam
352A	Kalmia loamy sand, 0 to 2 percent slopes
371	Kenansville loamy sand, 0 to 6 percent slopes
78	Lakeland sand, 0 to 6 percent slopes

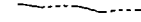
**LEGEND**

	Divided Highway
	Good Motor Road
	Poor Motor Road
	Railroad
	Project Boundary
	County Line
	Power Line
	Forest Fire Lookout Station
	Cemetery
	School
	Groins
	Borrow Pit
	Drainage
	Pond or Lake



Semiconrolled Mosaic of 1973 Photography  
 Prepared by USDA, Soil Conservation Service  
 Cartographic Unit, Fort Worth, Texas.

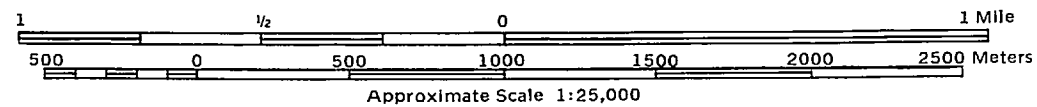

Handwritten text, possibly bleed-through from the reverse side of the page, located at the bottom edge.

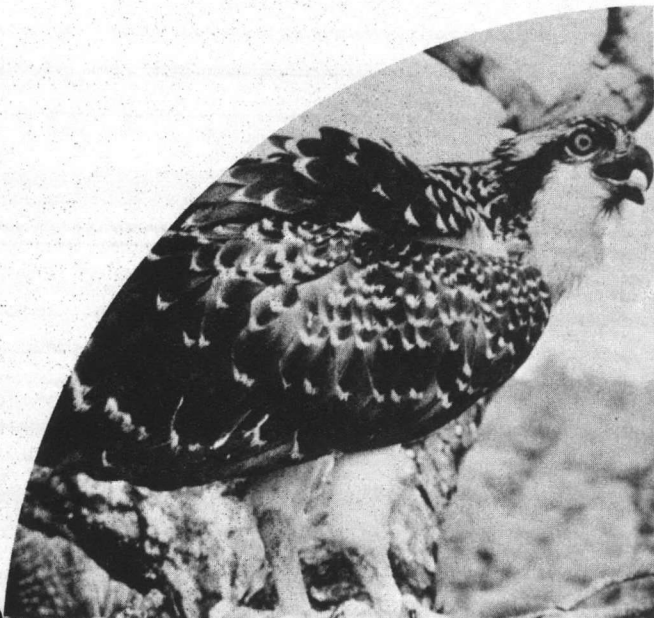

# WILDLIFE

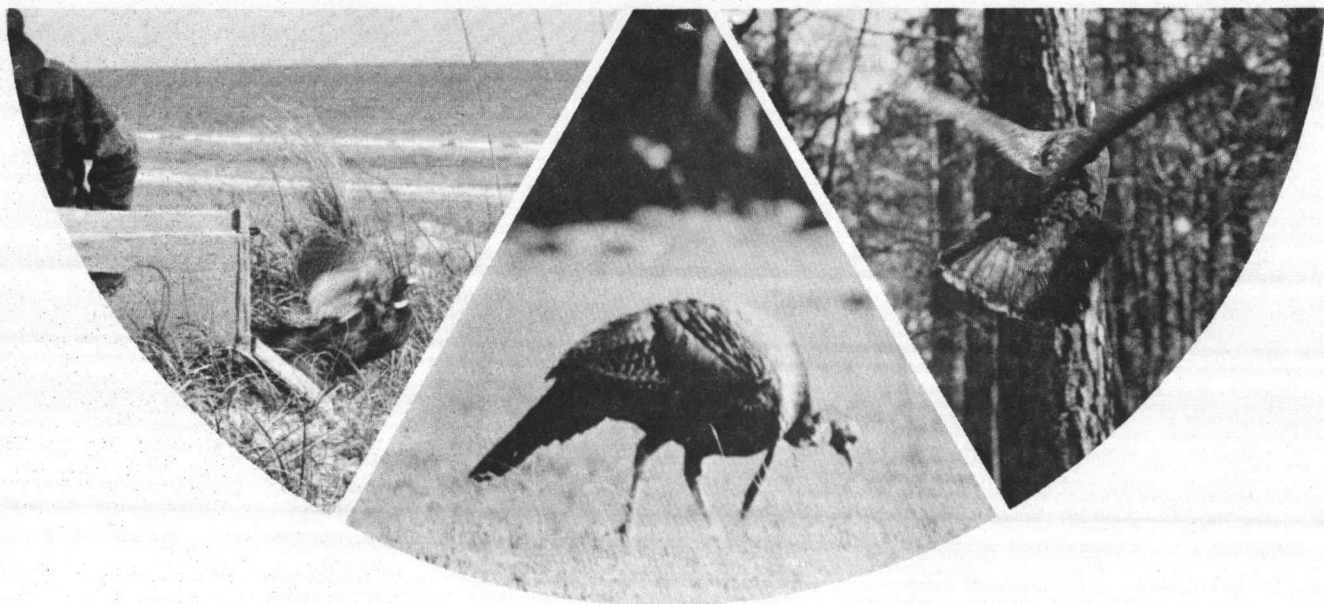

WILDLIFE



# WILDLIFE MANAGEMENT PROGRAM

## A. INTRODUCTION

There has been a pressing need over the last few years to establish comprehensive wildlife management programs to fit the increasing use of the Department of Defense lands by the American public. This plan complies with the guidelines established by the United States Marine Corps Headquarters in fulfilling projected needs for the next ten years.

Projected long range needs will be studied and considered anew on an annual basis. All levels of the program will be reappraised when formulating the Annual Operational Plan, and new projects or activities will be adjusted according to the context of what program needs are for the future.

Military training is recognized by this plan as being the primary use of these lands and is accordingly intended to consider this usage as well as the other uses thereof. The accomplishment of the Marine Corps in retaining and maintaining this habitat in such outstanding manner for almost thirty years is noteworthy.

Local land changes which affect the flora and fauna to the greatest degree are silvicultural practices. Local forest management practices are established under the United States Forest Service Guidelines which emphasizes multiple use of natural resources. Therefore, the United States Forest Service Wildlife Management Handbook is adopted as a basic guide for managing wildlife resources as it is compatible with local forest management practices for the interim period. Program planning and direction are enhanced by the North Carolina Wildlife Resources Commission, Bureau of Sports Fisheries and Wildlife and the United States Soil Conservation Service.

This plan takes into consideration both the consumptive and non-consumptive uses of wildlife resources. An inventory of fish and wildlife habitat has been accomplished within the year. This plan is not intended as the final management answer but to give improved direction to the local program which stands for continued improvement.

## B. USE OF SOIL INTERPRETATIONS IN WILDLIFE RESOURCE PROGRAMS

Wildlife is related to soils through an indirect relationship with plants. Wildlife species are associated with given types of plant communities which in turn are directly related to particular kinds of soils. Proper manipulation of soil, water and plants to produce suitable habitat is the most effective way to maintain and improve wildlife populations. It is through the three-way relationship of wildlife to plants to soils that interpretations for wildlife are prepared.

The soils of Camp Lejeune produce a wide variety of plants which provides food, cover and protection for many species of wildlife. Upland game species such as deer, grey squirrel, fox squirrel, quail, turkey and rabbit are abundant on the base.

Each soil mapped on the base has been rated for seven wildlife habitat elements with summary ratings made for the three kinds of wildlife for which one might expect to manage. It

should be emphasized that the ratings were made using criteria applicable to the individual element. The following is a brief explanation of each element:

1. Grain and Seed Crops - These are domestic grains or other seed producing annuals planted to produce wildlife food. Examples of these are corn, sorghum, wheat, oats, barley, millet, buckwheat, soybeans, cowpeas and sunflowers.

2. Domestic Grasses and Legumes - Ratings are for domestic perennial grasses and herbaceous legumes that are planted for both food and cover. Examples are fescue, lovegrass, switchgrass and cover.

3. Wild Herbaceous Plants - This refers to native or naturally established herbaceous grasses and forbs (including weeds) that provide food and cover. Examples are goldenrod, beggarweed, partridge pea and pokeweed.

4. Hardwood Trees - This group includes non-coniferous trees and associated woody understory plants that provide food and cover for wildlife species. Examples are oaks, hickory, autumn olive, dogwoods and poplar.

5. Coniferous Plants - These are cone-bearing trees and shrubs that furnish wildlife cover or supply food in the form of seed or fruit-like cones. Examples are pine and cedar.

6. Wetland Plants - Included here are annual and perennial wild herbaceous plants of moist to wet sites, exclusive of submerged or floating aquatics, that produce food and cover principally for wetland forms of wildlife. Examples are smartweed, wild millet, rushes, sedges, reeds, wild rice, cutgrass and cattail.

7. Shallow Water Areas - This element rates the suitability of the soil for the creation of shallow water areas. Surface waters usually have an average depth of less than five feet. They may be natural wet areas or those created by dams or levees or by water control devices in marshes or streams. Examples of such areas would be muskrat marshes, beaver ponds, waterfowl feeding areas and wildlife ponds.

The last habitat element deviates somewhat from the direct relationship of soils to plants to wildlife. It is listed, however, because of its primary importance to many species of wildlife.

The summary ratings for the different kinds of wildlife one might expect to find or manage for on a given soil are defined as follows:

1. Openland Wildlife - Birds and mammals that are generally associated with edges or open areas. These species are found in areas such as golf courses, pastures, lawns and idle areas overgrown with grasses, herbs, shrubs and vines. Doves, quail, rabbits and many species of songbirds are typical examples of wildlife one might expect to find in this group.

2. Woodland Wildlife - Birds and mammals of wooded areas containing hardwoods and/or coniferous trees and shrubs. Examples are squirrels and deer.

3. Wetland Wildlife - Birds and mammals that are found primarily in wetland communities

such as swamps, marshes or ponds. Examples are muskrat, raccoon, redwing blackbirds and various species of ducks.

The soils are rated for the three kinds of wildlife using four levels of suitability. This suitability is expressed by an adjective rating which can be defined as follows:

1. Good - Habitats are easily improved, maintained or created. There are few or no soil limitations in habitat management and satisfactory results can be expected.
2. Fair - Habitats can be improved, maintained or created on these soils but moderate soil limitations affect habitat management or development. A moderate intensity of management and fairly frequent attention may be required to insure satisfactory results.
3. Poor - Habitats can be improved, maintained or created on these soils, but the limitations are severe. Habitat management may be difficult and expensive and require intensive effort. Results are questionable.
4. Very Poor - Under the prevailing soil conditions, it is impractical to attempt to improve, maintain or create habitats. Unsatisfactory results are probable.

Soil properties such as solum thickness, flood hazard, drainage, available water capacity and slope are considered in making ratings.

When rating soil suitability for wildlife, a two-step procedure is followed. First, the soils are rated for their suitability for producing the seven habitat elements. Then, combinations of habitat elements are selected and weighed for their contribution to producing a given kind of wildlife habitat.

It should be noted that the ratings given in table 4 are to be used as guidelines and do not provide specific site analysis. Further on-site information and analysis will be required when developing individual management plans.



*This proso millet and sericea lespedeza plot provides food and cover for wildlife. Soil interpretations are valuable in plant selection and management for these plots.*



Table 4

## C. WILDLIFE HABITAT SUITABILITY INTERPRETATIONS

Series	Field Map Symbol	Class Determining Phase	POTENTIAL FOR HABITAT ELEMENTS								POTENTIAL HABITAT FOR:			
			Grain & Seed Crops	Grasses & Legumes	Wild Herb Plants	Hardwood Trees	Conifer Plants	Shrubs	Wetland Plants	Shallow Water Development	Openland Wildlife	Woodland Wildlife	Wetland Wildlife	
Baymeade	BA	739	1-6%	V Poor	Poor	Poor	V Poor	V Poor	-	V Poor	V Poor	Poor	V Poor	V Poor
Bibb	BJ		Undrained Drained	V Poor Fair	Poor Good	Poor Good	Poor Good	Poor Good	-	Good Poor	Good Poor	Poor Good	Poor Good	Good Poor
Bladen		853	Undrained Drained	Poor Good	Fair Good	Fair Good	Fair Good	Fair Good	-	Good Poor	Fair Fair	Fair Good	Fair Good	Fair Poor
Borrow Pit	B. P.													
Capers	CA		All	V Poor	V Poor	V Poor	V Poor	V Poor	V Poor	Fair	Fair	V Poor	V Poor	Fair
Corolla	CD		All	V Poor	V Poor	V Poor	V Poor	V Poor	-	Poor	V Poor	V Poor	V Poor	V Poor
Craven		558B 558C	1-4% 4-8%	Good Poor	Good Good	Good Good	Good Good	Good Good	-	Poor V Poor	V Poor V Poor	Good Good	Good Good	V Poor V Poor
Duckston	CD		All	V Poor	V Poor	V Poor	V Poor	V Poor	-	Poor	Poor	V Poor	V Poor	Poor
Johnston	BJ		Undrained Drained	V Poor Fair	Poor Good	Poor Good	Poor Good	Poor Good	-	Good Poor	Good Poor	Poor Good	Poor Good	Good Poor
Hureb	KL	704	All	V Poor	Poor	Poor	V Poor	Poor	-	V Poor	V Poor	Poor	V Poor	V Poor
Lakeland	KL		All	Poor	Fair	Fair	Poor	Fair	-	V Poor	V Poor	Fair	Fair	V Poor
Leon	LN	582	All	Poor	Poor	Poor	Poor	Poor	Poor	Poor	Poor	Poor	Poor	Poor
Lynchburg	RL		All	Fair	Good	Good	Good	Good	Good	Fair	Fair	Good	Good	Fair
Lynn Haven	LM		All	Poor	Fair	Fair	Poor	Poor	Poor	Fair	Fair	Fair	Poor	Fair
Murville	LM		Undrained Drained	V Poor Poor	Poor Poor	Poor Fair	Poor Poor	Poor Poor	-	Good Poor	Fair V Poor	Poor Poor	Poor Poor	Fair V Poor
Newhan		708	2-30%	V Poor	Poor	Poor	V Poor	V Poor	-	V Poor	V Poor	Poor	V Poor	V Poor
Norfolk	ON	365C	0-6% 6-10%	Good Fair	Good Good	Good Good	Good Good	Good Good	-	Poor V Poor	V Poor V Poor	Good Good	Good Good	V Poor V Poor
Onslow	ON	415	All	Good	Good	Good	Good	Good	-	Poor	Poor	Good	Good	Poor
Pactolus		460	All	Good	Good	Good	Good	Good	-	Poor	V Poor	Good	Good	V Poor
Pamlico	FM		Undrained Drained	V Poor Poor	Poor Good	Poor Good	Poor Good	Poor Good	-	Good Poor	Good Good	Poor Good	Poor Good	Good Fair
Pantego	TP		Undrained Drained	V Poor Fair	Poor Good	Poor Good	Poor Good	Poor Good	-	Good Poor	Fair Fair	Poor Good	Poor Good	Fair Poor
Rains	RL		Drained Undrained	Fair V Poor	Good Poor	Good Fair	Good Fair	Good Fair	Good Fair	Good Fair	Fair Fair	Fair Fair	Fair Fair	Good Good
Seabrook	WA											Fair	Fair	Poor
Torhunta	TP		Undrained Drained	V Poor Fair	Poor Good	Poor Good	Poor Good	Poor Good	-	Poor Poor	Poor Poor	Good Good	Good Good	Fair Fair
Wando	WA	722	All	Poor	Poor	Poor	Poor	Fair	Poor	V Poor	V Poor	Poor	Poor	V Poor
Woddington		833	Undrained Drained	Poor Fair	Fair Good	Fair Good	Fair Good	Fair Good	Fair Good	Fair Fair	Poor Poor	Fair Good	Fair Good	Poor Poor

#### E. WILDLIFE RESOURCES

Wildlife is classified as all living things which are neither human nor domesticated. Here at Camp Lejeune, wildlife means game birds and game mammals, salt and fresh water fishes and furbearing mammals. It also means song and insect eating birds, nongame mammals and birds and all the other naturally wild land and water mammals.

Within the wild kingdom every animal has its place in the grand design of nature. Every animal is important in the food chain whether classed as a predator, a game animal or a pest. The mosquito is as important as the deer; the honeybee has its place just as the bass; and the woodpecker means as much as the wild turkey.

Some people forget that alligators, lizards, turtles, frogs, toads, snakes and salamanders all have their place in the natural scheme of things. From the biological point of view, every animal is a predator - living on other animals or plants - and in turn is part of the food supply for the other animals. Survival is the most important thing in an animal's life - that means to eat or keep from being eaten.

Our wildlife resource is a heritage we guard. When we recognize wildlife as a crop of the land, it ranks fourth after industry, agriculture and forests in economic value to citizen landowners. Each year sportsmen spend millions of dollars in the pursuit of game fish. The sportsmen's dollar for license, permits and tax on hunting and fishing equipment pays for the conservation of wildlife resources. Aside from the wildlife value in dollars, there is the aesthetic value and above everything else is our responsibility to pass on the future generations the wildlife heritage we have enjoyed.

#### F. PUBLIC USE OF WILDLIFE

The public use objective of wildlife management is to provide the greatest possible satisfaction for consumptive and non-consumptive use for all the people. Management will be directed for providing wholesome enjoyment for using birds and animals. Some users will hunt them, some will observe them, some will photograph them and some will just listen to them.

The consumptive use will be primarily through recreational hunting and fishing. Overkilling of wildlife is virtually impossible because local hunting and fishing is biologically regulated. Hunters and fishermen use the surplus game resources that prevents waste which would otherwise be lost in the environment.

The consumptive user seeks out game, reduces it to possession and consumes it. Each of these require their own special skill and fulfill their own reward. Thus, the hunter or fishermen fulfills a unique privilege in a valuable interaction between himself and nature.

Extreme preservation of game species is a pitiful attempt at best in conserving that species. Loss of habitat causes the demise of a species; not the hunter or fisherman. Well regulated harvest of game species through hunting and fishing is far more favorable than natural loss through mass starvation or disease. Surplus game populations will be utilized through recreational hunting and fishing that is regulated to insure wise use of the resources.

Public fishing, trapping and hunting access is through a centrally located check station

near the main entrance to the base. Hunting access is dependent upon available space and at times that do not conflict with military training. Fishing access is not usually restricted except for impact areas, areas of high security and firing ranges when in use. Trapping access is not usually restricted except from residential housing areas, impact areas, security areas, and firing ranges. Civilian guests must be accompanied by a base employee or military personnel to avoid danger areas. Civilian access is on a first come-first served basis and each civilian guest is permitted access if they meet normal requirements for gaining access. Twenty-seven percent of all hunting access is comprised by civilian guests at present.

Non-consumptive users of wildlife include those that view them, those that study them, and those that photograph them. This plan recognizes non-consumptive use and is also committed to those people that have non-hunting interests. The prime factors in managing unharvested populations will include behavior, population dynamics, and habitat just as these factors are considered when managing populations that are harvested.

Education for the non-consumptive user will be directed to teaching individuals to identify major wildlife species and to appreciate the interrelationships existing in nature. Learning the principles concerning the biology and life history of wildlife species will increase the enjoyment of the users relationship with wildlife. Educational programs will be presented at every opportunity in the public schools, at scout activities, and to civic groups to promote non-consumptive use of wildlife.

The ease of viewing wildlife will be a prime objective in management for the non-hunter. Techniques to make wildlife more available to the user will be developed and promoted. However, in the interest of environmental quality, management for non-hunters will not include discontinuing proper regulatory harvest of game species. Dense populations can make wildlife more available to the non-hunter, but should not be the objective because of adverse factors which would develop when some game species become too numerous. Factors that offer the greatest improvement of habitat quality will receive prime consideration when planning for public use of wildlife.

Planning for the public usage of wildlife will also include improvement of hunter and non-hunter relationships. Those persons interested in non-hunting usage will be provided educational insight of the harvest aspect and its relationship to conservation of game populations. The hunter will be provided educational insight to the importance of non-hunting usage of wildlife for nature study and birdwatching.

Habitat quality will, primarily, determine the availability of wildlife for present and future use. Habitat quality will be governed by how well plant communities are managed, pollution abatement, controlling soil erosion, regulated harvests of game species and protection for non-game species. Any land use operation places an impact on the environment. Such charge may not be critical to the point of necessitating change or curtailment. However, in the best interest for the future of wildlife populations, natural resources management personnel should be included in any land use planning which could cause destruction to wildlife habitat.

The greatest expenditure in public use of recreational activities is where natural resources provide the basic facilities. The aesthetic value of using natural areas for recreation far out weigh the recreational value of artificial facilities. The hunter enjoys using a natural

hunting area far more than a game farm situation, the birdwatcher enjoys his sport in aesthetic value of natural areas are valuable to the average trooper engaged in military training.

Planning projects and improvements for wildlife will be devoted to fitting techniques of application which would be environmentally adaptable for retaining the unit as natural as possible. Natural areas are always high in recreational value and will always be protected from adverse change or degradation.

Table 5

G. ESTIMATED WILDLIFE RESOURCES VALUE

<u>Wildlife Unit 1 /</u>	<u>Featured Species</u>	<u>Planned Population</u>	<u>Planned Harvest</u>	<u>Possible Man-Days Hunting</u>	<u>Estimated Resource Value</u>
1,2,3,11,13,14	Deer	3166	316	6320	\$316,600
4,7,9,10,12	Turkey	1468	146	6650	220,200
5	Quail	9500	1850	6250	14,250
All Units	Squirrel	9000	1800	3600	12,250
All Units	Rabbit	4750	475	1425	5,900
6	Waterfowl (winter)	20000	1200	3600	60,000
All Units	Bear	70	7	700	14,000

1 / Total estimated replacement value at full stocking.

H. PERSONNEL REQUIREMENTS

The Fish and Wildlife Management Program is headed by the Wildlife Manager located in the Fish and Wildlife Branch, Natural Resources and Environmental Affairs Division, Base Maintenance Department. This position is responsible for the administrative supervision of overall application and manipulation of fish and wildlife management. The Wildlife Manager supervises a Biological Wildlife Technician and Wildlife Protector.

The Wildlife Technician is under the Wildlife Manager and is responsible for performing a variety of tasks in the day-to-day operations of this plan. The work includes planting and cultivation of wildlife food plots, small game strips, planting forest access roads to forage crops, establishing and maintaining wildlife openings, and maintenance of waterfowl impoundments. The technician will participate in habitat surveys, inventories, population studies, managing fish populations, determining degree of public consumptive or non-consumptive use of wildlife, and in planning improvements to the overall program.

The Wildlife Protector is supervised by the Wildlife Manager and is responsible for the enforcement of base, state and federal laws regulating the taking of wildlife. The Wildlife Protector is assisted by an Assistant Wildlife Protector and approximately ten voluntary Deputy Wildlife Protectors. Their duties consist of patrolling land and water areas, issuing citations for violations, issuing base permits to hunt, trap, or fish, checking hunters into and out of hunting areas, collecting survey information from sportsmen and disposing of illegally or accidentally killed wildlife.

I. FUNDING PROCEDURES

Permits for hunting, fishing, or trapping will be issued by the base Game Protector who will account for fees collected from the sale of permits. These fees will be deposited by the Game Protector to a special project account with the Base Comptroller. This project account will be expended against an Annual Operational Plan which conforms with the Long Range Management Plan.

TYPES OF PERMITS, FEES AND EFFECTIVE DATES

1. Combination Hunting and Fishing Permits	1 August - 31 July	\$2
2. Fishing Permits	1 January - 31 December	\$1
3. Special Hunting and Fishing Permits	1 August - 31 July	\$10
4. Special Daily Hunting and Fishing Permits		\$2
5. Trapping Permits	1 August - 31 July	\$3

J. DEVELOPMENT AND MAINTENANCE COST

Existing work projects which are justified for continuance are listed below. All projects are generally funded through collection of permit fees for hunting, fishing, and trapping. An exception to this source of funds is that funded under the Forest Management Budget for seeding forest access roads to control erosion and fire. Special Services Funds may also supplement the fish and wildlife program as needed and appropriate. Development and maintenance costs for the next ten years are based on existing costs during the current fiscal year. Salaries of management personnel are paid from appropriated funds.

<u>Project</u>	<u>Total Development</u>	<u>Annual Maintenance Cost</u>
Wildlife Food Plots	\$ 57,000.00	\$ 5,700.00
Small Game Strips	11,500.00	1,150.00
Wildlife Openings	3,300.00	330.00
Forest Access Roads	23,380.00	2,338.00
New Clearing Establishment	3,675.00	735.00
Establishing Shrub Plantings	300.00	30.00
Fish Ponds	7,000.00	700.00
Miscellaneous Management Equipment	750.00	75.00
Salaries	212,690.00	21,269.00
TOTAL	<u>\$319,595.00</u>	<u>\$32,327.00</u>

## K. AGRICULTURAL PRACTICES

Diversity of habitat is necessary for the management of many wildlife species. A system of clearings provides for edge effects, a diversity of food and cover, and adds to the general aesthetics of timberlands. Forage clearings enhance and supplement the natural food supply of wildlife. Grasses, grains and legumes are some of the more productive and less expensive plant materials for clearings.

Clearings and their attendant access roads provide excellent opportunity for the wildlife user. These clear vistas in the deep forest provide the user with opportunity to view, study, or photograph wildlife from concealed vantage points. Hunter success increases around clearings and access roads since game regularly visits these diversified sites.

Well spaced clearings are vital for retaining or increasing the wild turkey population in this predominate pine timber habitat. This is local justification in itself for using clearings to add diversification to the habitat. The overall objective in establishing or maintaining most of these clearings is their eventual composition to perennial legumes or grasses which require little management. New clearings will all be established to natural plants or grasses rather than to agricultural crops.

Each improved clearing that now exist or to be established in the future will be maintained in a husbandry condition. Consideration will be given to proper manipulation of food and cover within each clearing. Edges will be brushed as necessary to limit undesirable woody plant invasions. All such clearings will be mapped and marked with appropriate signs for field identification by wildlife users and management personnel. Appropriate records will be maintained on each improved clearing for management and planting.

Regular equipment requirements for maintaining these improved areas are farm tractors, a disc tiller, a seed and fertilizer distributor, a drag harrow, a rotary mower and a cargo truck. Labor requirements are a planting attendant to supervise the overall operation, tractor operator and a cargo truck operator.

Non-planted clearings will be established within sites prepared for as clearcuts or seed-tree cuts in the future. These type clearings will usually be from 1 to 2 acres in size. The present non-planted clearings will be maintained as grassy openings as will any newly established one. Establishment of non-planted clearings will be with dozer and heavy disc during forestry site preparation work. Natural grasses, forbs, fruits and legumes will emerge after discing during site preparation work on these designated clearings. New sites will be established prior to the nesting season of upland game. Maintenance will consist of discing or mowing during February and March at three year intervals to prevent invasion of undesirable plants. This maintenance schedule is after most natural foods of the clearing have been used and prior to emergence of new plant growth and nesting activity.

Perennial grass clearings are established in grasses and legumes during mid-May. Site preparation consists of discing with disc tiller and harrowing with drag harrow to prepare a good seedbed. Seed perennials at the rate of 15-25 pounds per acre and fertilize with 400 pounds of 8-8-8 commercial fertilizer per acre. Harrow lightly with drag harrow for proper covering of seed. Mow with rotary mower at three year intervals. Clearings planted to perennial

grasses or legumes will usually be from 1 to 2 acres in size.

Small game strips will be planted during May in the Quail Management Area and in Wildlife Food Plots. Prepare these small game strips by discing with disc tiller and harrowing with drag harrow. Seed annual mixtures at the rate of 25-35 pounds per acre and fertilize with 400 pounds of 8-8-8 commercial fertilizer per acre. Establish 17 acres of these plant materials at 59 planting sites.

Wildlife food plots are established to winter grains such as rye and/or wheat for fall, winter and early spring grazing. The planted area on each site will be left standing for nesting and feeding area throughout the summer. Prepare site with disc tiller and fertilize with 300 pounds of commercial fertilizer per acre. Seed  $2\frac{1}{2}$  bushels of rye and 2 bushels of wheat per acre. Harrow lightly with disc tiller to cover seed. Rotate these plantings within each food plot to improve cover, cereal production, and possible reduction of disease build up in the soil.

Forest access roads will serve as grassy openings and will be established to perennial grasses during early fall and spring. Long narrow openings are valuable because they provide maximum edge effect. Forest access roads comprise considerable acreage and are important for forest management access, hunting access, fire prevention, and military use. This acreage is put to productive use for wildlife by maintaining access roads as grassy openings and less land is required for meeting minimum requirements of openings for forest game. Prepare site by discing to road center with disc tiller which will leave drainage furrow on each side of road. Prepare firm seed bed with drag harrow. Seed with 15-25 pounds of perennial grasses per acre. Harrow lightly to cover seed with drag harrow. The overall goal of road planting is one mile of access road openings per 640 acres of land.

Shrub lespedeza plantings are established in the edge of clearings, along access roads, and on soil banks. This perennial produces large quantities of seed which is readily used by upland game. Select site and disc the site in the late fall. Plant dormant seedlings in February and March on sites which were previously disced in the fall. The planting site remains moist when established in this manner, insures better plant survival, and aids in hand planting of seedlings. Seedlings will be planted in rows two feet apart with one foot spacing in the row. Use a tree planting bar or spade to plant seedlings and pack earth firmly around the roots with a kick of the heel. Plant approximately six rows of seedlings per site. Fertilize with 50 pounds of 8-8-8 commercial fertilizer per 1,000 seedlings when plants begin to grow after transplanting. Maintenance of plantings will consist of rotary mowing or shrubing plants down at four year intervals for maximum seed production. Refertilize planting site every four years with 50 pounds of 8-8-8 fertilizer per 1,000 plants.

Fruit tree plantings consisting of autumn olive and glossy privet will be established in clearings planted to perennial grasses. Plantings will be established in clumps or in single rows in edges of clearings. Site preparation is not necessary in properly established perennial planted clearings. Plant during fall or late winter on well drained sites. Space plants 8 feet apart in clumps or in rows to permit spreading growth and maximum fruiting. Scalp off sod or other vegetation in a 3 foot square and place hole in the center to hinder weed growth. Work three heaping tablespoons of 8-8-8 commercial fertilizer into soil in bottom of hole, cover with fresh earth, and plant. Mulch with pine straw or sawdust to reduce summer weed competition and

to conserve moisture. During the first two years hand cultivate plants as necessary for weed control. Little fertilization is required after establishment but plants will be fertilized if the foliage indicates the necessity. Fruit tree plantings are heavily used by upland game birds and songbirds.

#### L. WILDLIFE-FORESTRY COORDINATION

The main objective for wildlife management in timberlands is to provide a variety and abundance of natural food and cover for native game species within their normal home ranges. This must be compatible with maintaining the forest in a vigorous condition of proper density and desirable composition for production of forest resources. Maximum yields of either forest or wildlife resources are not compatible. There must be some give and take from each to accomplish the multiple use concept.

Coordination between forest and wildlife management is aimed at the positive approach in making resource decisions rather than wasting efforts in pondering conflicts between these functions. All resource management is interrelated in applications and the complete approach must be considered in program manipulation.

The principle means by which timber and wildlife habitat needs are coordinated is through control of stand density and composition. Slight modifications in the degree of thinning and release of growth stock are required to benefit wildlife which causes variations from the approach of considering primary production of timber alone.

Even-age management is the new approach to managing the local forest, and can provide a highly attractive environment for wildlife and timber with proper attention to coordination. Even-age management will generally be applied to the higher uplands on sites which provide the best opportunity for timber production. Bottomland hardwoods, hardwood stands and inclusions on slopes or in uplands will be managed for wildlife.

The time to consider stand composition is during prescription work when stands are selected for alteration/regeneration. Prescription work will consider such prime requirements as continued timber production, understory management, mid-story management, and mast management. Additional considerations during prescription work will include protecting key areas, making necessary improvements such as clearings or forest access roads, and making the natural resource program compatible with the military use of the compartments.

The determination of carrying capacity of wildlife in a forest habitat is a very difficult problem. While timber species are relatively easy to inventory, wildlife species are very difficult. Continued effort will be made in attempting to determine wildlife needs in relation to the carrying capacity of the range.

Wildlife management will be coordinated with forest management activities with the prime objective to make both management practices as compatible as is possibly feasible. Management personnel engaged in the forest and wildlife program will work at ground level during compartment prescription work. Slight alterations which will make the two practices more compatible will be considered during prescription work in each compartment. The ecological principle for



a quality environment can be fulfilled through intense management of timberlands under the multiple use concept when those charged with management responsibility actively work together.

#### M. CENSUS TECHNIQUES AND HARVEST SURVEYS

Featured game species are deer, turkey, grey squirrel, fox squirrel, quail, rabbit and waterfowl. Censusing of featured game species will be determined through three separate indications for each species. This will allow more accurate sampling of an individual specie and this sampling scheme will lend itself to the collection of a variety of data at little additional cost.

Information on the deer population is derived from (1) track counts, (2) sight counts, interviews with hunters, and (3) reproductive studies. Turkey population indices are acquired by (1) counting young broods, (2) running gobbler counts, and (3) interviews with hunters. Squirrel population indices are indicated by (1) counts of leaf nests, (2) interviews with hunters, and (3) squirrel observed by management personnel. Quail population indices are noted by (1) covey counts using dogs, (2) interviews with hunters, and (3) morning calling counts. Rabbit population indices are determined by (1) track counts, (2) sight counts, and (3) interviews with hunters. Waterfowl indices are indicated by (1) aerial observation, (2) ground viewing, and (3) interviews with hunters. Bear population indices are derived through track counts and sight counts by observers in the wildlife units.

Each wildlife unit was inventoried during 1973 and will be re-inventoried thereafter at two year intervals to make habitat evaluations. Partial population indices are determined during these inventories and compiled with other data collected through the year to arrive at annual population estimates. All present species will be censused in each wildlife unit as completely and expeditiously as possible. The wildlife units contain many forest compartments which are indicated on the basic map in aerial photograph flight line sequence for easy reference. The inventory team surveys each compartment within the wildlife unit. Present wildlife population and trend data are indicated on Forest-Wide Habitat Survey Data Sheets for the entire wildlife unit. These data will be used to implement the Annual Operational Plan and this Long Range Management Plan.

#### N. MANAGEMENT PLAN

1. Deer Management. Deer is the featured species in Wildlife Units 1, 2, 3, 11, 13, and 14 in habitat which includes all forest management types. They will be considered in other wildlife units which also have good deer range.

Deer are widely distributed and heavily hunted throughout the entire area. Their home range seldom covers more than 300 acres during the year except for temporary range shifts to escape hunters or dogs.

The condition of the range is generally good with an abundant supply of browse, succulent herbage, fruits, fungi and agriculture plantings available for deer. There is an adequate supply of summer-fall foods to enhance the physical and reproductive condition of deer. Evergreen browse is readily available during the winter months and is a main stay during years of short mast crops. Food quality is more limited than quantity. Natural deer foods are low in phosphorous, nitrogen, or protein except in spring due to the low mineral content of the soil. Special

consideration will be given evergreens due to their approach to adequate levels of protein even in winter. Plantings in food plots, forest access roads and improved areas supplement the nutrient intake of deer and improve their physical well being.

Summer growth of dense foliage provides a wider cover dispersal for deer than other seasons. Evergreen vegetation provides good escape cover for protection during winter. An abundant supply of fresh water is available during all seasons and is widely dispersed throughout the range.

Mast trees are in fair supply but good hardwood sites either of stand size or as inclusions are relatively scarce. All bottomland hardwoods, hardwoods on slopes and in key areas will be retained through management to reach the recommended 20% hardwood goal of the United States Forest Service. All suitable drains regardless of size will be managed for hardwoods and wildlife.

In establishing key areas for deer consider bottomland hardwoods, evergreen thickets, oak hammocks, live oak clumps and all water areas. Select these key areas prior to harvesting and protect key areas during all silviculture operations.

Regeneration of pine timber through partial cuttings and frequent cutting cycle intervals will maintain continuous high quality deer habitat conditions. Shelterwood cuts, seed-tree cuts, and small clearcuts with consideration for good regeneration dispersal of even-aged stands are good methods for maintaining balanced deer habitat. Seed-tree cuts will be well dispersed and large enough to insure regeneration of desirable species yet not so large as to waste the valuable browse resources. Clearcuts in all units will be no more than twice the normal 600 to 800 feet which deer will move from the forest edge. Clearcuts are useful in providing semi-open fawning areas and places to loaf or play. Forbs and grasses are available in spring within clearcuts before forest browse species begin growth.

Prescribed burning through all units at five year intervals will increase deer food and cover. This interval permits excellent plant response, keeps browse plants within reach and never injures deer as the forest receives low burn. Areas burned will be well distributed throughout the units and key areas will be protected from fire as necessary.

The population objective is to obtain 1 deer per 30-40 acres and the harvest objective is 1 deer per 125-175 acres in the fall. The area deer population objective is 3,166 animals with an annual harvest of 316 animals. It takes 20 man-days of hunting to harvest one deer so this resource furnishes 6,320 man-days of hunting.

#### Recommended Management Goals for the Deer Resource

1. Increase the hardwood component of the wildlife units to 20% or more.
2. Lightly thin hardwood stands or inclusions for desired composition and to increase growth and mast production.
3. Use forest access roads for perennial plantings and establish one mile of these per 640 acres of forest land.
4. Retain portions of clearcuts as permanent openings as needed.
5. Protect all established key areas.
6. Control free running dogs when the hunting season is closed by live box trapping.

2. Black Bear Management. Bear are not featured in any one wildlife unit but will be considered in all units. There is approximately 13,700 acres of excellent bear habitat available throughout the wildlife units. This prime habitat consists of bays, pocosines, and bottomland swamps located in existing coastal forests.

Bear hunting has been prohibited since 1969 when a Bear Sanctuary was established throughout all wildlife units. The population at that time was from 16-20 individual animals. The population has since increased until there are now 40-50 animals present.

A research study was conducted during 1973 by the state and base authorities to determine local home ranges and population density. Eight bear were captured, tagged, and released during this study. One female bear was equipped with radio transmitter to determine movements of that individual specimen. Home range of the bear was determined to be about 640 acres.

Bear require habitat which is relatively inaccessible from human interference. They are very unadaptable to human populations and habitat destruction. Present habitat should be protected from forest access road construction, drainage or other land use which would greatly alter the existing wetland habitat which is required by bear.

Timber management practices largely determine habitat quality because the bear diet consists mainly of fruits and mast. Favored foods are black gum berries beechnuts and acorn in the fall. Cherry, dogwood, crabapple, thornapple, grape, and greenbrier are also important foods during the fall and early winter. Primary plant foods in spring and summer are dewberries, blackberries, huckleberries, persimmons and the inner bark from young poplar and sweet bay. Animal foods are also very important foods of the bear.

Hardwood sawtimber will be rotated at a minimum of 80 years in all key areas or inclusions where bear are featured. Pond pine, pond pine-hardwood, sweet gum, water oak, sweet bay, swamp black gum, and red maple are the types which afford prime opportunity for bear management.

Population objective is two bear per square mile. Plans are to open a season for bear hunting in the future provided the bear population continues to increase to the point that an open season is necessary. Bear provide only a very small percentage of potential use for the consumptive or non-consumptive user. Considerable public use, however, is provided by associated wildlife species which greatly depend on the same habitat which the black bear requires for its existence.

#### Recommended Management Goals for the Black Bear

1. Protect bear habitat from road construction, drainage, and human interference.
2. Manage hardwood sawtimber for long rotations.
3. Open season for hunting when there is a sufficient surplus of animals present.

3. Turkey Management. Turkey is the featured species in wildlife units 4, 7, 9, 10, and 12. Wild turkey will be considered in other units as well.

The home range of turkey has been established as about 640 acres through telemetry studies and is irregular in shape. Vast timberlands are necessary to support good populations of wild turkey. Present conditions of the turkey habitat throughout the range are considered good. Good habitat for turkey consists of mixed hardwoods and groups of conifers with open understories, scattered openings, well distributed water, and freedom from frequent disturbance.

Hardwood composition of numerous species is necessary to compensate for the variable nature of mast production. Conifers afford protection during adverse weather and prime roosting sites. Grassy openings provide insects, fruits, grass seeds, and forage which are very important for breeding, nesting, and brooding. Food plots planted to winter grains provide quality foraging especially during years of mast failures.

At least 200 acres of mast producing hardwoods per square mile in mixed stands, inclusions, or in key areas will be available in meeting food requirements. Sites suitable for quality hardwoods will be managed for turkey with at least half the basal area maintained in oaks, hickory, or beech. In mixed stands of pine hardwood, age classes will be distributed in small stand sizes of 20 to 50 acres with no more than 200 acres per compartment regenerated in any 20 year period. Mast production of hardwood trees usually begins at about 25 years of age and is greatest in stands 50 years or older. Shortening the length of rotation from 80 to 60 years where there is a balance of age classes will reduce the yields of mast available. Key areas such as hardwood stands or inclusions will be of utmost importance; thereby, requiring very intensive management. Long timber rotations are favored over short rotations because sapling and young pole stands are of little value except for escape cover. Clearcuts are favored nesting and brooding areas for about 5 years after regeneration but will be restricted to a maximum size of 50 acres or less of uneven shape where turkey are featured. Clearcuts will be well dispersed through units managed for turkey.

Prescribed burning offers an excellent opportunity in improving the palatability and the nutritional value of understory plants. Turkeys quickly move into burned areas in search of insects in the unburned litter especially around decaying logs. Later in winter and early spring, forbs, grasses, and tender browse which are used by turkey appear in the burned areas. Burning creates open understories where the birds can see for great distances in pine stands and increases the available food supply during summer. Key hardwood areas will be protected from fire by plowing or back firing.

Openings in the longleaf and loblolly pine types are very important for nest and brood sites, forage, starchy food, and fruiting shrubs. Natural openings will be maintained by mowing or disking at three year intervals. Forest access roads will be planted to perennial grasses such as Wilmington bahia grass, Kentucky 31 fescue, and ryegrass. Food plots will be planted to legumes and millets during spring and summer and for fall use by turkey. Fall plantings of rye and wheat will be established for green browsing through winter. Openings will be maintained within clearcuts after regeneration as necessary. Clearcuts offer a good opportunity for rotating openings which could very well be a factor in reducing the spread of disease.

The optimum is to establish and maintain 10% of the compartments in openings to include roadways, food plots, strips, and non-agricultural types. Water is not a limiting factor overall as there are permanent water sources within each square mile. Some natural ponds dry up during extended periods of light rainfall but other water resources are usually available within one-half mile. The minimum population objective is ten birds per square mile. This population density could furnish 350 man-days of hunting per 5000 acres. Approximately 10% of the birds could be harvested during spring gobbler hunts. Thus, the area turkey population objective is 1468 birds with an annual harvest of 146. The turkey resources can furnish approximately 6650 man-days of hunting each year. The range provides quality turkey hunting opportunity but hunting success has been very low due to inexperienced hunters. Hunter success is expected to improve during spring hunts until at least 10% of the birds are annually harvested. The overall future of the natural resources management program will center and be measured upon how successful the local habitat of the wild turkey is conserved.

#### Recommended Management Goals for the Wild Turkey Resource

1. Management of sawtimber employing long cutting cycle.
- \* 2. Management for open understories and even distribution of age classes of trees.
- \* 3. Retain or establish a 20% composition of mast bearing hardwoods within all wildlife units.
4. Establish 10% of area in clearings to include food plots, roadways, and drop zones.
5. Restrict clearcuts to an average of 50 acres.
6. Establish permanent openings where feasible within clearcuts until minimal requirements for openings has been met.
7. Apply good dispersion of areas selected for regeneration.
8. Rotate grain plantings within food plots from year to year.
9. Encourage utilization of turkey resources through consumptive uses.



*Wild gobblers utilize a food plot during winter when natural foods are scarce. Grassy openings are valuable for brood production during late spring and early summer.*

4. Grey Squirrel Management. Grey squirrels are not featured in any wildlife unit but will be managed throughout all units. Squirrels will be featured in all mixed stands or inclusions of pine hardwood over 5 acres in size.

Grey squirrels are widely dispersed and are the most popular small game mammal in the area. The home range of grey squirrel varies from 2 to 10 chains in diameter and from 1.5 to 8 acres depending upon age or sex and population density.

Grey squirrel range is relatively good and intermittent tracts of hardwood-pine types afford stable populations. Mixed stands provide a greater variety of food materials through the year. Large trees form an essential element of the habitat. Without them few suitable breeding places would be present and food materials would be less abundant. Timber stands below 50 years of age are rarely productive sites unless interspersed with den trees retained during previous cutting operations. Again, timber must be managed on long rotations for good mast production in order to feature and support squirrel.

In units featuring squirrel, den trees must be left when possible to retain grey squirrel. At least two den trees per acre will be retained in upland types and when hardwood stands or inclusions are regenerated.

In loblolly pine-hardwood types favor water, willow, laurel, southern red, and cherrybark oak. In oak gum-cypress types favor water, willow, southern red and chestnut oaks. In all the hardwood types favor as many den trees as are possible because this area has the greatest carrying capacity of all the local types.

When selecting key areas for squirrel consider den trees, small inclusions of ash-elm-maple, stands of beech, and grape tangles, in stands or in hardwood inclusions. Forest access roads enhance squirrel hunting and are very well dispersed through squirrel habitat. Prescribed burning has little effect on grey squirrels provided that fire is retained from key hardwood areas.

The population objective is a fall population of one squirrel per acre in hardwood and mixed pine-hardwood stands. This population could provide 3200 man-days of hunting and a harvest of 1800 squirrels.

#### Recommended Management Goals for the Grey Squirrel Resource

1. Leave two or more den trees per acre in regeneration of hardwoods.
2. Manage all five acres or larger inclusions for squirrel.
3. Retain or promote best mast composition in inclusions or hardwood stands.
4. Use long cutting rotations of hardwood timberlands.
5. Protect all established key areas for squirrel.
6. Reach a population of one squirrel per two acres in squirrel habitat.

5. Fox Squirrel Management. Fox squirrel are not featured in any one unit, but will be considered in all units.

The longleaf-slash pine types afford the best opportunity for managing fox squirrel. This habitat is preferred due to its savannah or natural prairie like characteristics. The fox squirrel tends to occupy range which seldom intermingles with the grey squirrel.

Home range of fox squirrels is normally from 5-10 acres depending upon sex and age of the animal. Daily movement seldom is more than 300 yards in diameter.

Habitat needs for fox squirrel will be met through retention and improvement of key hardwood areas in pine stands. Hardwood fringes of natural ponds provides good feeding and denning sites which will be retained as key areas. Clumps of willow and turkey oaks will be retained as key areas in the pine stands.

Prescribed burning provides a park-like understory which fox squirrel prefer. Cool winter burns, at five year intervals are employed to improve this habitat. Establish nesting boxes when economically feasible on sites lacking den trees. Fire will be excluded from hardwood den trees and mast trees.

The population objective is one squirrel per five acres in upland pine and pine-hardwood types. The fox squirrel resource can support an established 3-5 hunter trips per 100 acres in pine types.

#### Recommended Management Goals for Fox Squirrel Resources

1. Retain den trees throughout the habitat.
2. Manage all five acres or larger hardwood inclusions.
3. Protect established key areas.
4. Prescribe burn habitat for open understory.
5. Establish nesting boxes when feasible.
6. Reach population of one squirrel per five acres.



*Proper dispersal of hardwoods are essential to maintain squirrel populations.*

6. Quail Management. Quail is the featured species in wildlife unit 5 and will be considered in all units. Quail are well dispersed through the entire area and are a favorite small game bird. Limiting factor for quality quail hunting is that many units are not conducive to hunting due to thick pocosins, bays and swamps.

The upland pine types afford the best opportunity for quail management. Longleaf pine stands provide good quail populations and this type is well dispersed in unit 5. The open growing habitat of longleaf pine and this species tolerance to fire favors the growth of low vegetation.

Home range of quail covers about 40 acres. Quail live their entire life spans in a range of less than  $\frac{1}{2}$  mile. Young quail will seek suitable unoccupied range in the fall outside their brooding range but seldom move more than  $\frac{1}{4}$  mile.

Interspersed woodlands, brush, grass and cultivated plots furnish good cover. Native grasses, shrubs and brush of open-canopy pine stands furnish spring and summer cover. Brushy thickets of gallberry, huckleberry, blackberry and plum provide winter cover.

Forest composition of wider interspersed and distribution of age classes provides good quail habitat under the even-aged concept. Rotation will be for sawtimber. Thinning will be to lower limits of basal area within the quail management unit in pine stands.

Prescribed burning is very important in managing quail. Quail respond well to the open understory of pine stands through burning. Burning will be at three-year intervals in portions of unit 5. Legumes and grasses respond and are found in much higher quantity than in comparable areas which are burned at five year intervals. Fire will be excluded from drains, hardwoods stands or inclusions. Burns will be well distributed.

In considering key areas select drains, hardwood conclusions and fruit and nut produced by shrubs and promote the growth of a variety of seed producers to insure increased productivity.

Establish permanent plantings of annual seed mixtures in clearings and food plots. Make perennial grass plantings on forest access roads. Establish shrub lespedeza plantings in corners or edges of clearings or food plots.

The raising and releasing of pen-raised quail is not recommended and is locally prohibited by regulation. Pen-raised quail released in the wild fail to improve the overall population. The possibility of transmitting poultry diseases to wild quail and other wildlife will always be the factor considered most important in considering any attempt to release pen-raised birds. Quail population objective is one bird per four acres in longleaf pine habitat. The overall population objective is about one bird per ten acres for a total of 9,500 birds. The harvest objective is 20% of the total population or 1,850 birds.

#### Recommended Management Goals for the Quail Resource

1. Prescribe burn portions of the unit at three year intervals.
2. Retain openings, food plots, shrub plantings and forest access roads.
3. Keep well scattered dispersal of woodland regeneration.
4. Increase production of natural foods by discing travel lanes throughout the unit.



7. Waterfowl Management. Waterfowl will not be featured in any unit but will be considered in all wildlife units where wetland habitat occurs.

Waterfowl usage of the local habitats during the year is mainly migratory with the exception of wood duck. The New River watershed and the Coastal marshlands along the Intracoastal Waterway provide good feeding and resting grounds for both diving and puddle ducks. These marshlands are well dispersed with small potholes and abundance of open water.

Adjacent brackish waters of tidal creeks, bays, swamps, and fresh water ponds provide additional areas which are quite productive for waterfowl. In excess of 1600 diving duck were banded by base and state wildlife personnel in 1960. This was the largest number of duck that had been banded up until that time in North America and indicates the importance of the local waterfowl habitat.

Waterfowl management for most species primarily will be the retention of all wetland habitat. Such projects as channelization, marshland ditching, and land filling over tidelands or swamps are very detrimental to wetland habitat and will be discouraged.

The Town Point Waterfowl Impoundment is managed as a green tree impoundment for wood duck, mallards, black duck, and green-winged teal. This area covers a bottomland swamp with dense growth of mast producing hardwoods and an abundant plant supply. The fifteen acre impoundment is flooded in mid-October. This system maintains proper plant growth and provides surface water which increases puddle duck utilization of this particular area. Twelve nesting boxes for wood duck are erected in the impoundment and have received up to 60% nesting utilization.

The Sallier's Bay Waterfowl Impoundment which is adjacent to the Intracoastal Waterway is managed for wood duck, green-winged teal, lesser scaup, and mergansers. This impoundment is 40 acres in size and remains permanently flooded. Pondweeds and duckweeds have been introduced into this impoundment. Six nesting boxes for wood duck have been established within the impoundment to increase nesting activity.

Seventy-five nesting boxes for wood duck are established in fresh water ponds, marshes, swamps, and along fresh water streams. Annual nest box maintenance consists of clearing old nesting debris from boxes and placing new nesting material of sawdust and wood shavings. Boxes are inspected during and after the nesting season to determine nesting utilization.

Wood duck nesting boxes will be constructed of one inch rough cypress boards. Specifications for constructing the boxes are as follows:

Inside measurements - 24x10x10 inches, Hole - 3x4 inch oblong hole, 4 inches from the top, Top - two strips of wood on the underside to make snug fit in top of box. Install a screw-hook-eye to attach top to box on both sides of top. Bottom - 5 small drainage holes. Backboard - extend several inches above and below for nailing to post.

Erect nest boxes 5 feet above the water away from trees or brush and attach to a 4 inch cedar post. Attach a 24 inch galvanized metal cone to the post for protection from nest predators such as raccoons or snakes. Select sites to erect nest boxes that will receive little human interference during the nesting season.

The various species of migratory waterfowl which utilize these wetland areas are highly favored by the consumptive and non-consumptive user. Hunting for waterfowl in New River, the coastal bays, tributaries, and ponds is usually quite productive. Viewing waterfowl along the New River Shoreline is available for non-consumptive users during the winter months. The availability of viewing, studying, and photographing waterfowl will be promoted through management personnel contacts with the non-consumptive user.

#### Recommended Management Goals

1. Retain all wetlands from major changes that would adversely affect their physical and chemical well being.
2. Manage impoundments to improve their productivity of mast producing hardwoods and available plant composition.
3. Continue the erection of nesting boxes for wood duck.
4. Promote non-consumptive uses of waterfowl.

8. Rare and Endangered Species Management. The management of rare and endangered species will be comprised of (1) identifying and determining density of local populations, (2) habitat preservation, (3) species protection, and (4) management. The local management goal is to protect and preserve rare and endangered species in their native environment. The goal is not to prevent the use of wildlife by the public, but rather to prevent the extinction of those species which can be saved and encourage their management and conservation. Concurrent with identifying the species for their plight and the measures needed to improve their existing situation. Applicable habitat improvement for rare and endangered species will be implemented to protect these diminishing resources.

Benefits and value of wildlife go far beyond the market values of the individual fish, bird, or animal. An environment with many species is far more interesting than one that has only a few species present. A world inhabited only by domestic species could not compare favorably with the interest of the natural world and its variety. The value of threatened wildlife exceeds any tangible market price. Local wildlife users are finding more and more satisfaction in knowing that there are local populations of alligators, ospreys, and red cockaded woodpeckers present in the area.

#### Red Cockaded Woodpecker

The red cockaded woodpecker is present within pine forests of the area. This small woodpecker subsists on insects which attack pine trees and is very important in controlling these tree predators. Nesting cavities utilized by these birds are always in over mature pine trees with red heart disease. Individual nesting trees and small belts of mature pines for future nesting will be protected along the periphery of active nesting sites. Sites will be mapped, marked, and recorded for management reference and protection.

#### Alligator

Alligators are present within wetland areas and have increased in number as poaching has decreased. Local protection to prohibit the taking of alligators began in 1958. Wetland areas

are receiving protection from drainage and channelization which will insure favorable habitat for the alligator. A more precise inventory of alligator is planned for the near future.

#### Osprey

The osprey is a fairly common summer visitor to the area. Thirty-two active nests were observed during the spring of 1973. Eight artificial nesting platforms were established in 1973 to provide nesting sites to replace nesting trees that had been previously blown down by strong winds. The artificial nesting sites will be protected, mapped, and recorded for management planning.

#### Bald Eagle

A depleted species. Occasional sightings have been made during the last several years. These sightings are thought to be those of two known nesting pairs in a nearby National Forest. All sightings will be recorded of eagles in the future.

#### Carolina Cougar

A depleted species which formerly was very common. Very rare and infrequent sightings have been made in the past five years. The retention of pocosins, bays, and inaccessible swamps provide acceptable habitat for this large predator.

#### Dusky Seaside Sparrow

This bird is a regular migrant along coastal salt marshes during the winter. Some birds probably over-winter in the salt marshes during winters of milder temperatures. The salt marsh habitat of these birds has been protected from drainage and channelization.



*Unique habitat of endangered species such as this red-cockaded woodpecker is protected and preserved.*

O. HABITAT TYPES AND ASSOCIATED WILDLIFE

Type: Longleaf

Acreage: 9,600

Percent: 12

1. Description. The principle tree species of this type is longleaf pine. Turkey, blue-jack, blackjack, post, and willow oaks along with red bay, holly, and black gum are the associated species while gallberry, yaupon, low bush huckleberry, titi and chinquapin make up the lesser vegetation. Associated upland weeds and herbs are teaberry, fern and sawgrass.

2. Value of Wildlife. Wildlife value is usually low for overall population within this type. The grassy understory of this type is quite inducive to several species which require open park-like timber stands. Longleaf stands are usually in association with thick bays and pocosins which provide for good escape cover.

3. Suitable Game Species. Quail and fox squirrel will be featured in this type. An important associated species is wild turkey which finds longleaf stands quite inducive for nesting and brooding range.

Type: Loblolly Pine

Acreage: 33,721

Percent: 42.6

1. Description. This type represents the main timber stand composition of the area. Many loblolly stands now grow on sites which were once old farm homesteads. Persimmon, black cherry, red cedar, holly, dogwood and scrub oak are the associated species, while high bush huckleberry, chinquapin, gallberry, beauty-berry and wax myrtle make up the understory. Associated upland weeds and herbs are pokeweed, ragweed, smartweed, beggarweed and partridge pea.

2. Value to Wildlife. Young stands of loblolly pine are relatively low in wildlife value. Value for wildlife increases after timber operations and usually supports high densities of animal life. Pine mast is a fairly important food for many species. Young pine makes good all year cover for game birds and animals. Larger trees are favorite roosting and nesting sites for some game birds and songbirds.

3. Suitable Game Species. Deer, turkey, grey squirrel and quail will be featured in this type. Hardwood inclusions and key areas within this type produces much of the food necessary for featured wildlife species. Associated clearings in these types are very important due to the year-long canopy of loblolly pine. Prescribed burning of loblolly stands is also an excellent way to improving food and cover for featured species.

Type: Pond Pine

Acreage: 6,940

Percent: 8.8

1. Description. This group is composed of what is commonly known as "pocosins" or upland swamps. This group occurs on the poorly drained peat soils which are underlain with hardpan marine sands. Red maple, black gum, sweet bay and red bay are the associated species, while greenbrier, cyrilla, fetter bush and sheep laurel make up the understory. Associated marsh and aquatic plants are moss, fern, pitcher plant, venus fly trap and sundew.

2. Value to Wildlife. This type maintains a bountiful supply of evergreen vegetation which is available throughout the year for wildlife. Surface water is available and pocosins are seldom disturbed by human travel. This type is second in importance to wildlife when compared to the other timber types of the area.

3. Suitable Game Species. Black bear and deer will be featured in this type. Pocosins provide excellent escape cover for bear from human interference and is primarily responsible for the continued existence of black bear in the area. The extensive titi and gallberry bays afford good quantities of deer and bear foods even though these plants are low in nutrients. Bobcat, an important predator in the food chain, is also afforded prime habitat within this type for escape cover, feeding and lounging area.

Type: Loblolly Pine-Hardwood                      Acreage: 2,307                      Percent: 2.9

1. Description. This type occurs above the hardwood slopes and just below the pure stands of loblolly pine on higher upland sites. Sweet gum, black cherry, red cedar, holly, sweet bay and dogwood are the associated species, while high bush huckleberry, gallberry and wax myrtle make up the understory. Associated upland weeds and herbs are panicgrass, broomsedge, pokeweed, partridge pea and beggarweed.

2. Value to Wildlife. Mixed stands of loblolly-hardwood can be very productive for wildlife when stands are prescribed for long cutting rotations and are properly composed of mast producing hardwoods. Mixed stands add diversity to the overall habitat.

3. Suitable Game Species. Grey squirrel, wild turkey and deer will be featured in this type. There is also an abundance of fur-bearing animals within this type. These mixed stands of loblolly-hardwood should be managed to favor wildlife.

Type: Oak-Hickory                                      Acreage: 1,659                                      Percent: 2

1. Description. This type occurs on the slopes below the mixed stands of loblolly-hardwood and above bottomland hardwoods. Principle species are white oak and southern red oak. Black, post, chestnut and scrub oak, yellow poplar, sweet gum, black gum, persimmon, black cherry, maple and dogwood are the associated species, while blueberry, chinquapin and beauty-berry make up the understory. Associated plants and herbs are ferns, teaberry, paspalums and sedges.

2. Value to Wildlife. Hardwood stands on the slopes are very productive for wildlife when managed under long cutting rotation. Mast producing capability is increased when stands are comprised of a variety of mast producing hardwoods both in the understory and overstory. Wildlife should always be favored in all hardwood stands or inclusions on slopes.

3. Suitable Game Species. Grey squirrel, wild turkey, deer and wood duck will be featured in this type. Hardwood stands adjacent to streams and creeks provide excellent potential for mast production for native wildlife species. Important associated species in this type are furbearers and black bears.

Type: Sweet Gum/Water Oak/Cypress                      Acreage: 1,676                                      Percent: 2  
and Tupelo

1. Description. This type group occupies the rich moist bottomlands below the slopes and extends to the marine shoreline. Maple, black gum, hawthorn, sweet bay, red bay and elm along with hornbeam, holly, and mulberry are the associated species, while huckleberry, grape, muscadine and palmetto make up the understory. Associated aquatic plants are coontail, arrow cowlily, common duckweed, horned-pondweed and burreeds.

2. Value to Wildlife. Wildlife value of this type is very high and one of the most produc-

tive. A maze of foods is available throughout the year and excellent escape cover abounds within this type.

3. Suitable Game Species. Waterfowl, deer, bear, turkey and woodcock will be featured in this type. Excellent management potential exists for all these species due to wide dispersal of evergreen cover and available food supply. This timber type will be primarily managed for wildlife.

Type: Sweet Bay/Swamp Black Gum                      Acreage: 4,865                      Percent: 6.0  
          and Red Maple

1. Description. The flood plain of streams, creeks and swamps are sites where this type group occurs. Swamp tupelo, ash and elm are the associated species, while greenbrier, rattan-vine, grape and rose make up the lesser vegetation. Associated aquatic plants are wild millet, coontail, swamp smartweed and arrowhead.

2. Value to Wildlife. This type group is one of the most productive for wildlife. A good intermixture of evergreen shrubs, mast producing trees and excellent escape cover provides for high intensity management.

3. Suitable Game Species. Waterfowl, mink, otter, raccoon, deer, bear, woodcock and grey squirrel will be featured in this type. This type group will also be managed primarily for wildlife. Drainage or channelization projects should not be planned in the future within this type.

Type: Wildlife Food Plots                                      Acreage: 285                                      Percent: .36

1. Description. There are 56 wildlife food plots well dispersed throughout all units which average approximately five acres in size. Some of these were old fields which were kept open through the years, but most were cleared for cultivation during FY 62. Annual grains such as rye, wheat, brown top millet, proso millet, milo, soybean and cowpeas are seeded in wildlife food plots. Perennials such as sericea lespedeza, bahia and Kentucky 31 fescue are also seeded for wildlife utilization. Crabgrass, panicgrass, bristlegass and fox-tail grass are some of the more important wild grasses along with partridge pea and beggarweed which naturally occur within food plots.

2. Value to Wildlife. Wildlife food plots provide food and cover diversity within woodlands for wildlife which are very high in value. Natural foods are supplemented through agricultural plantings throughout the year, particularly during the late winter and early spring.

3. Suitable Wildlife Species. Wild turkey, deer, quail, dove and rabbit are featured within this type. Songbirds and insect eating birds will also be considered.

Type: Small Game Strips                                      Acreage: 15                                      Percent: .02

1. Description. Average size of small game strips in the Quail Management Unit is from  $\frac{1}{4}$  to  $\frac{1}{2}$  acre. There are 48 of these which are well dispersed throughout the unit. These strips are annually planted to seed mixtures during mid to late May. Associated vegetative species are brown top millet, proso millet and milo along with Korean and common lespedeza.

2. Value to Wildlife. Small strips are very useful in various pine types to supplement natural foods, and draw game populations for both the consumptive and non-consumptive user.

3. Suitable Game Species. Quail, rabbit and wild turkey will be featured in this type. Many songbirds are present through the year as this type is quite inducive to them.

Type: Wildlife Openings                      Acreage: 64                      Percent: .06

1. Description. There are 35 openings which vary from  $\frac{1}{2}$  to  $\frac{1}{4}$  acre in size. Edge effects are maintained through mowing or discing at three year intervals. This promotes grasses and prevents woody succession which maintain optimum plant production. Associated grasses are crabgrass, fox-tail grass, pannicgrass and bristlegrass along with sericea and common lespedeza, partridge pea, beggarweed and broomsedge.

2. Value to Wildlife. Small openings within timberlands are very important for enhancing the needs of forest wildlife. Grassy openings provide nesting, feeding and lounging areas for many species of forest wildlife. Insects are more dense in and adjacent to openings. Openings provide opportunity for increased contact between various species and the wildlife user.

3. Suitable Game Species. Wild turkey, quail, rabbit and deer will be featured in this type. Wildlife openings also contain a variety of nongame birds and animals throughout the year.

Type: Tactical Landing Zones                      Acreage: 380                      Percent: .4

1. Description. This type is used for helicopter landing sites and various troop training exercises. These types are mowed each year with rotary mowers to prevent woody succession. There are twelve locations which vary from 6 to 90 acres in size. Associated vegetative species are perennial grasses, bristlegrass, pannicgrass, pasapalum, crabgrass, beachgrass, broomsedge along with goosefoot, pigweed, chickweed, partridge pea, common and sericea lespedeza and ragweed.

2. Value to Wildlife. Wildlife value is high around the edges of these types but decreases further away from the woodline in the larger sites.

3. Suitable Game Species. Dove, quail, rabbit, deer and wild turkey are featured in this type. Dove plantings will be made in strips on some of these type for more intensive dove management.

Type: Firing Ranges                      Acreage: 757                      Percent: 8

1. Description. Firing ranges are utilized for small areas and artillery firing. These types are semi-improved areas in varying degrees of plant succession. Associated vegetative species are trees (loblolly pine, longleaf pine, the oaks, holly and dogwood), woody shrubs (chinquapin, crabapple, beauty-berry), upland weeds and herbs (ferns, partridge pea, pokeweed, beggarweed and greenbrier).

2. Value to Wildlife. This type provides excellent cover for mast game species. Succulent fruit and browse are abundant during much of the year. Nesting cover is provided by maintaining these ranges in semi-open condition.

3. Suitable Game Species. Deer, quail, rabbit and turkey will be featured in this type. Live firing seldom restricts game use of these areas with the possible exception of occasional accidental deer mortality. Turkey nesting has been observed within live firing ranges.

Type: Explosive Ordnance Impact Areas Acreage: 5,342

Percent: 6.7

1. Description. These types are used for impact of heavy ordnance from artillery aircraft. The sites are burned often to reduce the fire danger to adjacent woodlands. Human travel is prohibited within these types. Associated vegetative species are trees (pond and loblolly pine, the oaks, the maples and the bays), woody plants (fetter bush, cyrilla, sheep laurel, greenbrier, beauty-berry, sumar and huckleberry) and marsh and aquatic plants ( ferns, pitcher plant, mosses, fly traps and sundew).

2. Value to Wildlife. Impact areas are of high value to many wildlife species due to the available evergreen cover and food production potential along with protection from human travel. These sites provide excellent protection and good escape cover.

3. Suitable Game Species. Deer, bear, and wild turkey are featured in this type. Wildlife as well as the wildlife user can benefit from these types which serve as protected refuges for many wildlife species.

Type: Tidal Marsh

Acreage: 3,326

Percent: 4

1. Description. The local tidal marshland is one of the few remaining areas along the coastline of North Carolina which have been kept relatively free from filling or other man-made changes. Associated vegetative species are marsh and aquatic plants, algae, cattails, saltgrass, cordgrass, bulrush and spikerrush.

2. Value to Wildlife. Wildlife value in this type is very high. Migratory waterfowl, shorebirds and marine resources are greatly dependent upon this type for survival. These marshes, in association with salt water ponds and creeks, provide a maze of food and cover. Tidal flooding of these types provides the nutrient organisms for shellfish and other aquatic species of marine life.

3. Suitable Game Species. Marsh hen and diving ducks will be featured within these tidelands. Associated wildlife such as alligator, shorebirds, raccoon and river otter will be considered within this type. This is a critical environment which should not be altered in the future.

Type: Coastal Beaches

Acreage: 1,645

Percent: 2

1. Description. This type is relatively unspoiled from man-made change. A small portion of this type is used for bathing and for recreational activities. A small portion is also built up to house a small military command unit on the beach. Associated vegetative species are trees (live oak and red cedar), woody plants (greenbrier, yaupon, wax myrtle and palmetto) and weeds and herbs (sea oats, beachgrass, butterfly pen, Virginia creeper, swamp mallow and passion flower).

2. Value to Wildlife. This type is of low value to most game species in comparison to some other types. Live oak-cedar-yaupon thickets provide excellent evergreen cover along with good quantities of herbage.

3. Suitable Game Species. Deer will be featured within this type. Associated wildlife such as many species of shorebirds and several furbearing animals will also be considered in this type.



Type: Housing - Industrial

Acreage: 6,730

Percent: 8.5

1. Description. This type includes housing, residential areas, built-up areas, industrial areas and recreational areas.

2. Value to Wildlife. Wildlife value in this type is generally low overall. Value increases when these areas are in association with small woodlots, streams and grassy areas.

3. Suitable Game Species. Game species will not be featured within this type. These areas are more suited for songbirds although such game species as deer, squirrel, quail, rabbit and dove commonly frequent this type.



*Habitat evaluation is a continuing part of fish and wildlife management. This visual indicator measures impact of deer browse on a yellow crab-apple planting.*

P. INVENTORY PRESENT GAME SPECIES

A forest wide inventory of present game species was conducted in FY 73. Fourteen wildlife units were established for the purpose of formulating management area designation for featuring game species. Each wildlife unit was inventoried and these data were recorded on the 1 - 14 data sheets which follow the inventory of game species.

1. BIG GAME ANIMALS

a. Black Bear

(1) Habitat Factors and Conditions. This species favors remote timberlands in extensive tracts where human travel is low. Bottomland swamps, bays and pocosins afford the best habitat. These areas have been retained from drainage or road construction in the past. The entire base is established as a sanctuary for bear. Present bear habitat totals 15,140 acres.

(2) Population Status. Present number is estimated to be about 40-50 animals.

(3) Availability. Seldom observed by most humans due to the thick terrain which this species inhabits.

(4) Present Use. None for sporting purposes. Population and telemetry studies were conducted through live trapping during FY 73 and 74.

(5) Harvest or Control. None. Resources will likely be hunted as population allows in the future.

b. White-tailed Deer

(1) Habitat Factors and Conditions. The white-tail is the favorite game animal and occurs in all woodland habitat types. These animals are usually found in the forests but frequents glades or woodland openings while feeding. Deer are extremely adaptable animals to present conditions and to human populations. Overall deer range is good with a bountiful quantity of food and cover available. Present habitat totals 75,986 acres.

(2) Population Status. Deer are estimated to number 3,300 animals. The herd has steadily improved in quality since FY 59 when the first either-sex hunts were conducted.

(3) Availability. The species is abundant and are often viewed along the roadways and openings near timberlands. Easy to view.

(4) Present Use. 1,500 hunters, 6,320 man-days hunting

(5) Harvest or Control. 300 - 400 bucks, spike horned or more and 150 - 200 antlerless deer of either-sex every two years.

2. UPLAND GAME BIRDS

a. Bobwhite Quail

(1) Habitat Factors and Conditions. Favors margins where two distinct vegetative types meet and form an edge. This bird thrives best where an abundance of insects and plant seeds are present. Best timber types for quail of the area is longleaf pine. Natural and planted clearings are available to also enhance this species. Quail habitat totals 47,129 acres.

(2) Population Status. Present estimate is about one bird per ten acres.

(3) Availability. Commonly seen throughout the range.

(4) Present Use. Quail hunting is quite popular with the public but hunting is difficult due to the thick escape cover in most wildlife units.

(5) Harvest or Control. Hunters bag about 400 - 500 birds annually.

b. Morning Dove

(1) Habitat Factors and Conditions. Found in virtually all habitat types throughout the year. Favored forest habitat is longleaf and loblolly pine. Wildlife openings, agricultural crop plantings and forest clearcuts are favored by dove. Favorite feeding places are in open areas where seeds can be gleaned readily. Dove fields are planted annually. Total area of dove habitat available is 69,256 acres.

(2) Population Status. This species is relatively abundant. Number of birds using the area has been somewhat lower for the past several years than in proceeding years.

(3) Availability. Usually found in greatest numbers near plantings and openings.

(4) Present Use. 150 hunters, 300 man-days of hunting

(5) Harvest or Control. 400 - 500 birds harvested annually. Most birds are harvested almost entirely in agriculture plantings.

c. Wild Turkey

(1) Habitat Factors and Conditions. Native wild turkey inhabit most habitat types and is the favorite upland game bird in the area. This bird must have extensive tracts of wild and wooded country consisting of mast producing trees to survive. Forest openings are very important and are available to supplement brooding requirements. Existing habitat is good and should receive high priority for retention from adverse interference. Wild turkey habitat totals 59,914 acres.

(2) Population Status. Present estimates are about 800 - 900 birds. The flocks have increased from about 500 - 600 birds present in FY 66. Establishment of key openings, retention of key areas, better enforcement of regulations and spring gobbler hunting have enhanced the wild turkey.

(3) Availability. Rarely seen by the public. Excessive human interference can adversely effect wild turkey.

(4) Present Use. 400 hunters, 1,200 man-days of hunting. Live trapping and restocking state areas.

(5) Harvest or Control. 14 birds taken in FY 73. Hunter success is low but is expected to increase in the future as spring hunting becomes more popular. More birds should be harvested.

3. UPLAND GAME MAMMALS

a. Cotton-tailed Rabbit

(1) Habitat Factors and Conditions. Favors habitat near the edge of grassy openings and wooded uplands, but local habitat exists near forest clearcuts, openings and food plots, loblolly pine and loblolly pine-hardwood types. Habitat for this species totals 39,188 acres.

(2) Population Status. This species is widely distributed over the area but are not really abundant. Rabbit require habitat similar to that of bobwhite quail which is not

overly available where forest game such as squirrel, deer and wild turkey are featured.

(3) Availability. Not readily available.

(4) Present Use. Very light hunting occurs for this species. Less than 200 hunters seek cottontails.

(5) Harvest or Control. Less than 200 harvested annually.

b. Marsh Rabbit

(1) Habitat Factors and Conditions. Favors the lower timber zones of coastal forests near creeks, swamps and both fresh and salt water marshes. These animals require wetlands with thick brush cover and a good supply of herbaceous plants. Habitat conditions are ideal in these local lowlands for marsh rabbit. Habitat available for this species is 9,867 acres.

(2) Population Status. This species is very abundant.

(3) Availability. Marsh rabbit are not readily available for the average user due to difficult access to this wetland habitat.

(4) Present Use. Few hunters actively seek this species. Hunting can be quite productive using dogs on many of the islands located in some of the estuarine areas.

(5) Harvest or Control. Less than 300 harvested annually.

c. Grey Squirrel

(1) Habitat Factors and Conditions. This species is the favorite small game mammal with local wildlife users. Hardwood timberlands consisting of the oaks, hickory, beech, maples and dogwood are favored habitat. Mature hardwoods provide mast in the way of acorns, hickory nuts and beechnuts during winter. Hardwood stands should be intensively managed for maximum mast production. Grey squirrel habitat totals 44,228 acres.

(2) Population Status. Estimated population is about one squirrel per five acres in mixed stands of pine and hardwood.

(3) Availability. The grey squirrel is readily available to the wildlife user. These animals are easily viewed within housing-industrial areas and throughout most other habitat types.

(4) Present Use. They are heavily hunted each year. About 2,500 man-days are expended by hunters while seeking grey squirrel.

(5) Harvest or Control. Approximately 1,800 are taken annually.

d. Fox Squirrel

(1) Habitat Factors and Conditions. Favors upland forest zones consisting of open understories. Best habitat types consists of longleaf pine and loblolly pine-hardwood. Prime habitat occurs where mature longleaf pine and turkey oak are present. Existing fox squirrel habitat is in good condition. There are about 11,907 acres available for this species.

(2) Population Status. Present population is about one fox squirrel per five acres.

(3) Availability. These animals are plentiful and are often seen throughout their habitat. Few hunters seek them because they are difficult to hunt in the open habitat which

they occupy.

(4) Present Use. No hunting during the 1973 - 74 season when a state-wide regulation prohibited taking this species was established.

(5) Approximately 250 - 300 animals taken annually prior to 1973-74 hunting season.

#### 4. SHOREBIRDS AND MARSH BIRDS

##### a. Wilson's Snipe

(1) Habitat Factors and Conditions. Favors fresh water wetlands in open boggy margins of small streams and marshes. It is characteristic of coastal flats covered with low vegetation.

(2) Population Status. This winter migrant along the coast is relatively abundant.

(3) Availability. Difficult to hunt due to the wet habitat frequented by these birds.

(4) Present Use. Snipe are taken incidental to waterfowl or woodcock hunting.

(5) Harvest or Control. Present harvest is about 50 - 100 birds annually.

##### b. Clapper Rail

(1) Habitat Factors and Conditions. This species is locally referred to as the "marsh hen" and favors the marshes that occur along the Intracoastal Waterway and the margins of tidal streams. There are 3,326 acres of rail habitat available.

(2) Population Status. Rail are very abundant each year throughout the tidal marshes. It is quite common to see them throughout the year.

(3) Availability. Birds are plentiful but are difficult to hunt. Some hunters walk through the marshes. Hunter success increases, however, when boats are used during periods when marshlands are flooded during high tide.

(4) Present Use. Approximately 25 hunters expend 100 man-days each year.

(5) Harvest or Control. Current harvest is 300 birds. More birds could be harvested to utilize the resource.

##### c. Coots

(1) Habitat Factors and Conditions. Favors all wetland types along the various creeks, bays and the river. Prefers streams with relatively open understories along the shoreline. Approximately 10,000 acres of habitat are available for these birds.

(2) Population Status. Previous winter estimate tallied 1,200 birds.

(3) Availability. Easily viewed along New River and its tributaries by bird-watchers.

(4) Present Use. Hunter take this species incidental to hunting for waterfowl.

(5) Harvest or Control. Less than 200 are taken annually.

##### d. Gallinule

(1) Habitat Factors and Conditions. This species favors thick brushy areas along the margins of lowland swamps and marshes. Local habitat for gallinule is excellent and

consists of about 9,867 total acres.

(2) Population Status. Gallinule are common through much of the year with the exception of the cooler winter months. These birds breed within the tidal marshes of the area.

(3) Availability. Birds are commonly seen.

(4) Present Use. Very light as this bird is not a popular sporting bird. Most gallinule are taken by rail hunters.

(5) Harvest or Control. Probably less than 50 birds are taken annually.

e. Woodcock

(1) Habitat Factors and Conditions. Favors woodland swamps and leafy thickets along streams and fresh water marshes. This popular game bird inhabits grassy fields and meadows as well as lowland woods where a plentiful supply of earthworms exist. There is a total of 10,507 acres of prime habitat for these birds.

(2) Population Status. Woodcock are quite abundant. These birds are commonly seen throughout the year with breeding populations in spring and migrating birds passing through in winter.

(3) Availability. These birds are easily viewed around housing-industrial types during wet periods in winter. Hunters who seek them have no trouble flushing woodcock in winter.

(4) Present Use. Light hunting pressure but expected to increase.

(5) Harvest or Control. Less than 100 birds taken annually.

5. WATERFOWL

a. Ducks, Geese and Mergansers

(1) Habitat Factors and Conditions. The New River Watershed was once one of the most popular waterfowl areas in Southeastern North Carolina. Old-timers remember when ducks and geese "blotted out the sun" as they made their flight over the river. Waterfowl declined steadily through the years since the dredging of the Intracoastal Waterway. Puddle duck decline has been much greater than that of the diving duck. Great "rafts" of diving ducks are still commonly observed on the river. Salt marshes, small creeks, ponds and fresh water marshes are available for feeding and resting areas. There are about 11,526 acres of wetland habitat available.

(2) Population Status. Winter inventory of all the waterfowl area tallied approximately 20,000 birds.

(3) Availability. Birdwatchers enjoy observing diving duck along New River in winter. Hunters enjoy gunning the marshes, bays and river in season.

(4) Present Use. Waterfowl are hunted by jump shooting the small watercourses from small boats and the various shorelines. Hunters hunt the larger bodies of water from blinds using decoys and trained retrievers.

(5) Harvest or Control. Waterfowl gunners bag is estimated at about 3,500 birds annually.

b. Baldpate

(1) Population Status. Baldpate are fairly common migrants that resemble coots in concentrating on the vegetative parts of aquatic plants. They feed near diving ducks on plant particles which the diving ducks bring to the surface.

(2) Present Use. Hunters bag baldpate incidental to primarily seeking other species of waterfowl.

c. Black Duck

(1) Population Status. This favored migratory game bird has declined in recent years. Present number is estimated to total about 3,500 birds.

(2) Present Use. Hunters seek to bag this bird along small tidal creeks and coastal marshes. Estimated harvest is about 500 birds.

d. Bufflehead

(1) Population Status. This diving species is wide spread over the area on the river, bays and ponds. Approximately 2,000 birds are taken annually.

(2) Present Use. Waterfowl hunters do not usually actively seek this species. Present estimates indicate 400 - 500 birds are taken annually. High use opportunity available for birdwatching.

e. Canvasback

(1) Population Status. Many rafts of canvasback are commonly observed offshore along the river bays and larger creeks. Recent estimates tallied 4,500 birds.

(2) Present Use. Birdwatchers along New River and Northeast Creek from French Creek to the scout area have viewing opportunity to use this species. At present season is closed.

f. Goldeneye

(1) Population Status. The goldeneye is wide spread but is one of the less abundant species. This diving duck is usually found on open water with other diving ducks. Less than 200 birds were tallied during the inventory.

(2) Present Use. Birds bagged by hunters are incidental to other waterfowl hunting.

g. Mallard

(1) Population Status. Approximately 1,000 mallards were present on Wallace and Southwest Creeks. This species has declined more than others in recent years.

(2) Present Use. Hunting success is low. Probably less than 200 birds are bagged annually.

h. Pintail

(1) Population Status. This is an uncommon species throughout the area at present. Occasional sightings are made in the lower reaches of New River during migration.

(2) Present Use. Very light. A few birds are bagged by waterfowl hunters from blinds in New River.

i. Redhead

(1) Population Status. This is not a common species. Small rafts are observed near New River and Brown's Inlet each year.

(2) Present Use. Protected by closed season at present.

j. Ring-necked Duck

(1) Population Status. This species is very difficult to inventory due to its similarity to the scaup. About 400 - 500 birds are estimated to be present.

(2) Present Use. Probably less than 50 birds taken annually by hunters while primarily seeking lesser scaup.

k. Ruddy Duck

(1) Population Status. A common species that is one of the smaller diving ducks. This duck is equally at home in the river and bays along the coast. Estimated population is 3,000 birds.

(2) Present Use. Good opportunity exists for viewing these birds as they form rafts between the Hospital Point and Paradise Point areas of New River. Hunters take less than 400 birds annually.

l. Lesser Scaup

(1) Population Status. Lesser scaup are more numerous than any other duck in the local area. The most recent inventory tallied about 6,000 birds.

(2) Present Use. Favored by local hunters who annually bag about 2,000 birds. Provide easy viewing for many persons along New River.

m. American Scoter

(1) Population Status. This species is very common offshore bird of open water. Small rafts are often seen during winter at Brown's, Bear and New River Inlets.

(2) Present Use. Very light. Rarely taken by the hunters and receive minimum use from birdwatchers. The scoter is a third rate game bird.

n. Surf Scoter

(1) Population Status. This species is large offshore sea duck which is abundant around the inlets.

(2) Present Use. It is not a popular game bird and is rarely taken by hunters. Low value for wildlife viewing.

o. Green-winged Teal

(1) Population Status. This species is abundant along the tidal creeks and ponds, particularly the ones on Onslow Beach. This is the smallest species in the duck family.

(2) Present Use. This bird is a favorite species with local hunters. No other member of the duck family can change direction with such lightning precision, which makes it an elusive target for the hunter.

p. Wood Duck



(1) Population Status. This species is popular and abundant in the upper reaches of all the tidal creeks, ponds and fresh water marshes. The wood duck continues to increase in number.

(2) Present Use. One of the favorite ducks with local hunters. There are about 300 birds bagged annually. Birdwatchers find difficulty in viewing this bird of the woods which inhabits bottomland hardwood areas.

q. Hooded Merganser

(1) Population Status. This fish-eating duck is abundant and is commonly observed along the Intracoastal Waterway, bays and tidal streams during migration.

(2) Present Use. Not a popular sporting species although some birds are taken by hunters while seeking other waterfowl. Not expected to become a popular sporting species.

r. Red-breasted Merganser

(1) Population Status. Abundant. A bird of the coastal salt marshes, bays and sounds during winter.

(2) Present Use. These birds are lightly hunted. The species have poor eating qualities for the table and are not very desirable with hunters.

6. FURBEARERS AND PREDATORS

a. Raccoon

(1) Habitat Factors and Conditions. These animals occur in all habitat types but are partial to open woodlands. They favor riparian habitat where they like to feed and explore. Abundant water is necessary for raccoon habitation where much of their food comes from the water habitat. Prime raccoon habitat totals 79,312 acres.

(2) Population Status. Overly abundant. Competes with other species for food and cover. Pest in housing-industrial areas.

(3) Availability. Quite available. Easily located in all parts of the habitat.

(4) Present Use. Trapping and hunting. First trapping season was established in FY 73. Trapping had not been allowed since the Base was established. Trapping is utilized to control the population and wisely use the resource.

(5) Harvest or Control. Cooperating with the State Wildlife Commission in moving live-trapped raccoon to Western North Carolina to help control population.

b. Opossum

(1) Habitat Factors and Conditions. A very adaptable species. This animal occurs in every habitat type preferring bottomlands near branches and creeks. Equally at home almost any place as it will eat almost any kind of animal food or fleshy fruit. There is a total of 79,300 acres of habitat.

(2) Population Status. Over abundant. Pests around garbage cans and housing areas.

(3) Availability. Can be found almost any place and are very available.

(4) Present Use. Low use. Trapping is about the only use and that is very light.

(5) Harvest or Control. More animals should be harvested because they are known to compete with other wildlife. Hopefully, trappers can be induced to take more opossum.

c. Striped Skunk

(1) Habitat Factors and Conditions. This species favors habitat where an available supply of invertebrate and vertebrate organisms are present. They are present in the higher uplands. The habitat of this species totals about 43,321 acres.

(2) Population Status. Difficult to inventory but these animals are quite numerous.

(3) Availability. Not commonly seen even though they are present in good numbers.

(4) Present Use. None. Not used to any degree for obvious reasons.

(5) Harvest or Control. None, with the exception of few occasions when animals were trapped and removed from around buildings or are road killed.

d. Mink

(1) Habitat Factors and Conditions. This species is definitely aquatic, but spends a lot of time on creek banks and traveling across country from one stream to another. Mink habitat totals about 7,541 acres.

(2) Population Status. Mink are abundant throughout all wetland habitats.

(3) Availability. Available but seldom seen.

(4) Present Use. None. May receive light trapping in the future.

(5) Harvest or Control. None harvested at present. The resource should be wisely utilized in the future by trapping.

e. Weasel

(1) Habitat Factors and Conditions. This animal favors upland types as well as bottomland types and is widely distributed. They like both wet and dry situations where they can find a bountiful supply of small mammals for food. Total weasel habitat totals about 63,000 acres.

(2) Population Status. Very difficult to inventory, but they are observed to be present over the entire area.

(3) Availability. Seldom seen even though they are wide spread.

(4) Present Use. None at present.

(5) Harvest or Control. Some animals may be harvested in the future by trapping but is not expected to receive much use.

f. River Otter

(1) Habitat Factors and Conditions. This interesting furbearer favors the habitat of creeks, bays and salt marshes where it finds protective cover and a bountiful food supply. It also inhabits fresh water ponds and waterfowl impoundments which have been constructed in past years. Total habitat acreage for this species is about 10,867 acres.

(2) Population Status. Otter is numerous in the local habitat. Few animals have been locally taken from this habitat for the last 30 years.

(3) Availability. Not readily available for viewing.

(4) Present Use. These animals are not easily observed by wildlife viewers. Occasional observations are made from occupants of boats of some of the creeks and sounds.

(5) Harvest or Control. None at present. Animal will probably continue to be numerous for years to come.

g. Muskrat

(1) Habitat Factors and Conditions. Confined to wetlands through the upper reaches of Southwest Creek. High raccoon populations are responsible for limiting the spread of muskrat.

(2) Population Status. Very low number present.

(3) Availability. Very rarely seen.

(4) Present Use. None.

(5) Harvest or Control. None. Could become an important furbearer when raccoon population is reduced.

h. Grey Fox

(1) Habitat Factors and Conditions. This species favors upland habitat where an abundance of small mammals are present for food with dense escape cover nearby. Likes to travel while hunting on roadways and trails. Total grey fox habitat totals 79,312 acres.

(2) Population Status. Grey fox are numerous and valuable predators throughout the habitat. They help control small rodents in the area.

(3) Availability. These animals are available but are difficult to view. Most animals are seen at night.

(4) Present Use. Fox are hunted during open gun seasons for other animals when they may also be taken.

(5) Harvest or Control. Less than 25 animals taken by hunters each year. Not actually hunted.

i. Red Fox

(1) Habitat Factors and Conditions. Favors higher upland habitat where it can find good denning sites. Red fox are native to this lower coastal zone and were first positively identified on the area in FY 66. Total habitat totals 47,129 acres.

(2) Population Status. The number of red fox is low although they have steadily increased since moving into the area.

(3) Availability. Not common and probably will not be very common in this particular habitat in the future.

(4) Present Use. Rarely are they taken by hunters.

(5) Harvest or Control. Only a few taken annually.

j. Bobcat

(1) Habitat Factors and Conditions. This second largest predator of the area favors secluded forest habitat where human travel is relatively low. They are well distributed

over the area and even enter the industrial-housing types at night. This secretive animal requires thick vegetative cover. About 69,312 acres of habitat are available.

(2) Population Status. This predator is a common resident and maintains a good predator-prey relationship with other wildlife of the area.

(3) Availability. Good number present but rarely observed. Tracks and scats indicate their presence in the area.

(4) Present Use. A hunting season is established and these cats may be taken by hunters. No primary hunting for this species at present.

(5) Harvest or Control. Only a few are taken by hunters while hunting other game.



*Predators are important in the natural food chain for their sanitizing effect on the environment by controlling sick, weak, and injured animals.*

Q. INVENTORY PRESENT NONGAME SPECIES

Nongame wildlife species comprises the largest amount of our valuable wildlife resources. They receive less interest from the general public. However, their great involvement in the physical well being of the total environment is of no less importance than that of game species. Management, care and protection of these valuable nongame resources are planned now and for the future. Present nongame mammals are not detailed in this plan as are the more popular nongame avian species.

MAMMALS

(Other than game and furbearers)

	<u>SPECIES</u>
Shrews	3
Moles	2
Bats	10
Flying Squirrels	1
Harvest Mice	1
White-Footed Mice	1
Wood Rats	1
Rice Rats	1
Cotton Rats	1
Lemmings	1
Voles	1
Old World Rats	2
Jumping Mice	1
Armadillo	1

<u>BIRDS</u>	<u>FAMILY</u>	<u>SPECIES</u>	<u>CHARACTERISTICS</u>
Grosbeaks Finches Sparrows Buntings	Fringillidae	24	Birds with short bills for seed-cracking. Beautiful birds which are both colorful and provide some of the most pleasing outdoor sounds.

<u>BIRDS</u>	<u>FAMILY</u>	<u>SPECIES</u>	<u>CHARACTERISTICS</u>
Loons	Gaviidae	2	Winter migrants. Large submarine like birds of large bodies of water which frequent the three inlets and New River. Feed entirely on animal matter.
Grebes	Colymbidae	3	Pied-billed breeds here and the other two species are winter migrants. Grebes are poor fliers but champion divers. Very similar to the Loons subsisting mainly on crustaceans, mollusk and aquatic insects.
Shearwaters Fulmars	Procellariidae	4	These are offshore oceanic birds. Flights of Shearwaters can be viewed with field glasses off Onslow Beach.
Storm Petrels	Hydrobatidae	2	Birds of the open ocean. Can be seen following fishing boats offshore. Little black birds with white rump patches.
Tropic Birds	Phaethontidae	1	Oceanic birds which are seldom seen from land spending most of their life at sea.
Pelicans	Pelecanidae	1	The species has large throat pouches and are still observed around the three inlets in summer. Large, bulky, fish eating birds.
Gannets	Sulidae	1	Oceanic birds which migrate offshore. These are very large birds about the size of geese. They resemble the Kingfisher when fishing offshore.
Cormorants	Phalacrocoracidae	1	Dark birds which can often be seen flying in single file very low to the water a short distance offshore. They seem to challenge the waves as they maneuver near the water. These birds feed on fish, crustaceans and marine worms.
Darters	Anhingidae	1	This species is popularly known as the water turkey. Water turkey seem to swim like a snake or submarine in water. Usually observed in lowland swamps along watercourses of the area. Eats about any nongame fish or other aquatic animal life of the water.
Hérons Bitterns	Ardeidae	8	Wading birds with long legs and necks and pointed bills. Foods consists of fish, crustaceans, amphibians and insects. Most fish are the slow-swimming nongame variety. The American Egret of this family is becoming quite common locally.
Swans	Cygninae	1	Rare migrants along the coastal zone. Large bodied and beautiful birds that resemble geese in flight. Feeds on vegetable matter.
Geese	Anserinae	1	The snow geese is a rare migrant here and is protected by law. This bird also feeds on vegetable matter.
Vultures	Cathartidae	2	Eagle like birds very dark in color which are common to everyone as carrion eaters. Excellent natural garbage collectors.

<u>BIRDS</u>	<u>FAMILY</u>	<u>SPECIES</u>	<u>CHARACTERISTICS</u>
Short-Winged Hawks	Accipitrinae	2	These species are less desirable than others due to the fact that they tend to feed on game birds, songbirds and to a lesser degree on rodents.
Buteos	Buteoninae	4	These hawks are large birds of prey with large broad wings and tails. These birds subsist on many various rodents some of which can be destructive. Small game, snakes, lizards and insects are also eaten by this family. Very useful in food chain.
Eagles	Buteoninae	1	Rare birds. Occasionally observed migrating through the area. Hopefully we await possible local nesting of this bird again in the future.
Harriers	Circinae	1	Commonly known as the marsh hawk which is easily identified by its white rump patch. It subsists on rodents, amphibians, reptiles and other birds.
Ospreys	Pandionidae	1	Locally known as a fish hawk. The local habitat is an important nesting area for these birds of prey.
Falcons	Falconinae	2	Streamlined hawks with slim wings which provides great speed.
Oystercatchers	Haematopodidae	1	Large shorebirds with white wing patches and a large red bill.
Plovers Turnstones	Charadriidae	6	Medium size shorebirds which are found in small flocks along the beach, mud flats and water margins. Their food consists almost entirely of animal matter.
Sandpipers	Scolopacidae	16	This family consists of a diversity among the many species. These birds are very common along the beach and lake margins and are familiar to many people. These birds feed on mollusks, crustaceans and marine worms. Only a few species feed on plant food.
Phalaroper	Phalaropodidae	2	These are birds of the open water which resemble the sandpipers but prefer the water habitat. They occur as winter migrants passing through the area. These birds feed on insects and aquatic animal matter.
Jaegers	Stercorariidae	2	Oceanic birds that resemble falcon or hawk-like birds. They occasionally are sighted inshore but usually remain out to sea.
Gulls	Larinae	5	These birds are great fliers. Gulls spend most of their time onshore, but their main feeding is done in the water. They are sometimes referred to as "buzzards of the sea" as they scavenge for food. The gulls help clean up marine garbage and other waste.
Terns	Sterninae	8	This species is one of the most graceful fliers and are especially plentiful along the coastal zone. These birds feed almost entirely on aquatic animals.

<u>BIRDS</u>	<u>FAMILY</u>	<u>SPECIES</u>	<u>CHARACTERISTICS</u>
Skimmers	Rynchopidae	1	Black skimmers can be observed flying just offshore where it effectively catches fish and shrimp which comprise most of its animal diet.
Owls	Tytonidae Strigidae	4	The owls are very common in this area. These nocturnal birds of prey fly about silently feeding on small mammals, birds, frogs and large insects.
Goatsuckers	Caprimulgidae	3	These bewhiskered nocturnal birds are seldom seen but often heard because they rest in the daytime and feed on insects at night.
Swifts	Apodidae	1	This swallow-like bird is a very agile flier that flies about through the day feeding on insects. Their diet consists of insect matter.
Humming Birds	Trochilidae	1	Humming birds are the smallest birds in the world. They are the most versatile flyers and have exceptional flight ability. These birds feed on nectar and insects from flowers.
Kingfishers	Alcedinidae	1	A common bird throughout the area. It feeds mainly on fish but also eats lizards, frogs, crayfish and other aquatic animal matter.
Woodpeckers	Picidae	7	Some woodpeckers feed on insects while others feed on nuts, seeds and fleshy fruits. Most woodpeckers are very useful to man.
Flycatchers	Tyrannidae	5	Flies and other winged insects furnish food for these birds. Many insect pests are consumed around the urban and forest areas by these birds.
Larks	Alaudidae	1	This is an abundant species around large openings and housing areas. They are shy, quiet, ground-dwelling birds that feed on grass and weed seeds.
Swallows	Hirundinidae	5	Insectivorous birds which capture their food on the wing. These birds are very beneficial in controlling beetles, wasps, flies, bugs, moths and winged ants. The purple martin is a well known species of this family.
Crows Jays	Corvidae	4	These birds are saucy opportunists that prefers acorns, grains, pine seeds, fruits and insects as its chief foods. Some species are professional robbers of the foods that other birds have gathered.
Titmice	Paridae	2	These small birds are easily found exploring the woods, calling and feeding. Foods consist of seeds and insects.
Nuthatches	Sittidae	2	These small chubby birds have a peculiar habit of creeping with head downward on branches and tree trunks. Pine seeds supply good portions of their diet. Insects are also important food.
Wrens	Troglodytidae	4	These active birds are adapted to a diversity of environments. They can be found throughout woodlands, in marshes and garden shrubbery.



<u>BIRDS</u>	<u>FAMILY</u>	<u>SPECIES</u>	<u>CHARACTERISTICS</u>
Wrens (continued)	Troglodytidae	4	Insects and spiders are the main foods of Wrens. The Carolina Wren will readily nest in bird houses.
Mockingbirds Thrashers	Mimidae	3	Very common birds locally. Enjoyable songbirds that nest in shrubbery and fruit trees. Fruits and insects provide foods for these birds.
Thrushes Robins Bluebirds	Turdidae	6	Very common and enjoyable birds of the area. These birds have adapted themselves very well to civilization. These birds are partial to a diet of fleshy fruits for their subsistence.
Gnatcatchers Kinglets	Sylviidae	2	Except for humming birds, these birds are about the smallest birds. They are entirely insectivorous and feed upon very small delicate species. Very active and cheerful birds.
Pipits	Motacillidae	1	Winter migrants which feed on weed seeds in fall and winter.
Waxwings	Bombycillidae	1	Easily identified by its long top crest which no other brown colored bird possess. Very fast feeder which rapidly gobbles up its food. Main foods consists almost entirely of fleshy fruits.
Shrikes	Laniidae	1	These birds have an odd habit of hanging their prey on vines, thrones of bushes and barbed wire which has earned them the name of "butcherbirds." Their food consists of insects, rodents or birds.
Starlings	Sturnidae	1	An introduced species native to Europe which has proved to be a regrettable and uncorrectable mistake. A grand example of why game managers advocate through studies before any exotic is introduced into any habitat.
Vireos	Vireonidae	6	Vireos are small tropical birds which are found throughout the woodlands and are difficult to identify. Their calls are very distinct. Insects and spiders are commonly eaten by Vireos.
Wood Warblers	Parulidae	24	Warblers are insectivorous woodland birds. These birds consume an enormous amount of forest insects and may be valuable in containing insect attacks in our forests. Very colorful songsters and favorites with nature lovers.
Weaver Finches	Ploceidae	1	Another introduction from the old world that has become a pest and competes with native birds for food and nesting areas.
Meadowlarks Blackbirds Orioles	Icteridae	9	These birds feed on seeds, grains, fruits and usually in open or semi-open areas.
Tanagers	Thraupidae	1	These brightly colored birds are primarily insect eaters. Some fleshy fruits are also eaten.

R. FISH MANAGEMENT

Eleven fresh water ponds totaling 33 acres are under management to provide public fishing which supplements fishing use of existing fresh water streams. Eight of these ponds are natural and the remaining three were constructed. Those ponds or any which may be constructed in the future must be properly stocked and managed to provide sustained fishing with satisfactory annual yields of fish and a reasonable cost for maximum public use.

A suitable pond site must contain three characteristics, (1) a topography that may be converted into a pond economically, (2) a subsoil that contains an adequate water holding capacity and (3) a water supply that will maintain a full pool but not excessive runoff. Ponds will be built in natural hollows or draws by constructing the dam across a narrow neck to impound the water. This reduces construction costs since use is made of the natural features on three sides of the pond. The water depth should be from 8 to 20 feet along the dam and the water depth along the shoreline should be a minimum of  $1\frac{1}{2}$  feet to reduce emergence of aquatic vegetation at full pool. Borrow pits providing fill for construction of the dam should be made on the upstream side and located so that the site will be covered with water at full pool.

Native fish which might be present will be eliminated with five percent rotenone at the rate of 5 to 10 ppm after the drain valves are closed at the new pond site. This will be accomplished in the total watershed area above the dam four weeks prior to stocking. Small portable sprayers will be used to apply the rotenone.

New ponds will be limed with 2,000 pounds of agricultural limestone per acre prior to flooding the pond bottom. This will reduce the acidity of the soil and will be continued as necessary to maintain the acidity-alkalinity rate near the neutral level.

Stock new or reclaimed ponds with 1,500 bluegills, redear sunfish per acre in the fall and with 400 largemouth bass the following May. Stock 600 channel catfish per acre in bluegills, redear or largemouth bass ponds in the fall. Stock 1,000 channel catfish per acre in ponds that have single channel catfish populations which are on feeding schedules.

Fertilize all ponds beginning in February and continue to October at intervals necessary to maintain growth of plankton dense enough that a submerged white object can not be seen deeper than about 12 inches. Fertilize with 40 pounds of 20-20-5 per acre at each application. Make first application during mid-February, the second application 15 days later, the third and subsequent applications necessary thereafter at 30 day intervals. Broadcasting is not necessary and each bag of fertilizer may be simply dumped into the pond, preferably at an upstream location above the dam. In addition to providing a high production of fish, proper fertilization will give good control of submerged aquatic plants which can become a nuisance without control. Lime at the rate of 100 pounds of agricultural limestone per acre until neutral water pH is reached. Maintain water chemistry at neutral level.

Chemical makeup of pond waters will be maintained at proper levels for maximum productivity. Management personnel will make regular checks with testing kits to determine adjustments necessary in managing pond waters. Each pond will be checked monthly from May through October by the seining technique to determine fish population density. Creel data and seining records will be reviewed periodically to determine changes occurring within fish populations. Corrective

restocking of fingerling largemouth bass and seining will be accomplished to prevent overcrowded forage fish populations which could result in serious management problems.

Aquatic waterweeds are undesirable in ponds and will be controlled through the application of aquatic herbicides. Pond shorelines will be eventually deepened to a minimum of  $1\frac{1}{2}$  feet to eliminate the growth of waterweeds. The shorelines of ponds will be cleared of brush to a minimum of 10 feet from the water to provide access for fishing and management purposes. Exposed areas along shorelines where the soil has been disturbed will be grassed in with bermudagrass, ryegrass or Kentucky fescue.



*Productivity of fish is measured to aid in proper distribution of age classes.*

S. FISHERY HABITAT AND ASSOCIATED FISH RESOURCES

HICKORY POND - 5.5 acres; pH - 6.6; O<sub>2</sub> - 6 ppm; TH - 34 ppm;  
866422                      Temperature - 89°F; Average width - 75 feet;  
Average depth - 5 feet; Bloom - 30 inches

This pond was constructed in 1968 and stocked with bass, bluegill and redear sunfish. The pond did not fill with water until 1970 and then after a short time the water dropped to six feet below normal pool. The pond filled in 1971 and remained full until the summer of 1973 when the water level again dropped below normal pool. Inspection has revealed that swimmers diving and swimming from the water control pipe caused the pipe connection to loosen resulting in reduction of normal pool. This problem has since been corrected. Numerous small and intermediate bluegill were present in 1971. Seine samples in 1972 revealed no reproduction from bass and bluegill and only adult bass and bluegill up to one pound. Seine sample analysis in 1973 revealed good bass and bluegill reproduction. The pond apparently suffered an overpopulation of bass in 1971 which resulted in abnormal reproduction in 1972. The population has corrected itself at present as indicated by an optimum population of both bass and bluegill.

Recommendations

1. Maintain proper water chemistry.
2. Continue fertilization program.
3. Check annual reproduction.

HENDERSON POND - 14 acres; pH - 7.0; O<sub>2</sub> - 7 ppm; TH - 34 ppm;  
868422                      CO<sub>2</sub> - 5 ppm; Temperature - 82°F; Average width -  
150 feet; Average depth - 9 feet; Bloom - 14 inches

This pond was completed and stocked with bluegill, redear sunfish and channel catfish in 1971. The dam washed out and the fish were lost, however, repairs were made and the pond was restocked in December 1971. Bass were stocked in the summer 1972. Bluegill reproduction was not present until late August 1972 due to the late stocking of bluegill in 1971. The Commanding General dedicated the pond in July to Mr. W. N. HENDERSON, Base Game Protector 1945 - 1966. Mr. HENDERSON is deceased and the dedication ceremonies were attended by his surviving relatives and friends. The pond was officially opened to fishing during the dedication by Mrs. HENDERSON who made the first cast. HENDERSON POND is now providing quality fishing to the public.

Recommendations

1. Continue fertilization programs.
2. Maintain proper water chemistry.
3. Stabilize shoreline near dam on each side of pond.
4. Limit vehicle traffic on dam to prevent erosion.

PRINCE POND - 1.0 acre; pH - 6.4; O<sub>2</sub> - 3 ppm; CO<sub>2</sub> - 50 ppm;  
899310 TH - 51 ppm; Temperature - 84°F; Average depth -  
3 feet; Bloom - 24 inches

This pond was renovated with rotenone in 1967 and restocked with 2,000 channel catfish. The pond is restocked annually with channel catfish. The catfish are fed commercial pellets daily to increase growth. Aquatic duckweed is a problem in this pond which requires spraying with herbicides for control. Weights of channel catfish in this pond vary from one to ten pounds. Bass fingerlings were introduced in this pond to control mosquito fish in 1971. Fishing for channel catfish is very productive.

#### Recommendations

1. Continue feeding program.
2. Control weeds with aquatic herbicides.
3. Increase bloom to assist in controlling aquatic vegetation.
4. Stock with 1,000 channel catfish annually.

HOG PEN POND - 1.0 acre; pH - 6.4; O<sub>2</sub> - 3 ppm; CO<sub>2</sub> - 50 ppm;  
884301 Total hardness - 51 ppm; Temperature - 88°F;  
Average depth - 3 feet; Bloom - 30 inches

This pond was renovated in 1967, restocked with 2,000 channel catfish and opened to fishing in 1968. The pond is stocked with 1,000 channel catfish annually. The catfish are fed daily with commercial pellets to increase growth. The fish range in size from 10 to 32 inches and the pond provides good fishing. The bass do not appear to be seriously affecting the catfish population but are utilizing the mosquito fish.

#### Recommendations

1. Continue feeding program.
2. Fertilize as needed to maintain bloom.
3. Maintain creel records.
4. Restock annually with 1,000 channel catfish.
5. Check for bass production on catfish.

MILE HAMMOCK POND - 1.5 acres; pH - 7.3; O<sub>2</sub> - 7 ppm;  
874279 CO<sub>2</sub> - 15 ppm; Total hardness - 34 ppm;  
Temperature - 84°F; Average depth - 3.5 feet;  
Bloom - 20 inches

This pond was renovated in 1965 and stocked with bass, bluegill and redear sunfish. Ten to twelve inch channel catfish were stocked in this pond in 1970. This pond has remained in good condition since it was renovated. Seine samples have revealed bass and sunfish reproduction each summer since renovation. This is a very productive pond and produces some nice catches.

WARD POND - 1.5 acres; pH - 6.5; O<sub>2</sub> - 8 ppm; CO<sub>2</sub> - 10 ppm;  
872286 Total hardness - 34 ppm; Temperature - 85°F;  
Average depth - 5 feet; Bloom - 35 inches

This pond was renovated in 1965 and restocked. It was opened to fishing in 1967. Fishing was good until aquatic weeds covered the pond in 1972. These aquatic weeds are gradually being controlled and this pond should again provide good angling. Bass, bluegill and redear have reproduced in this pond each year since renovation.

Recommendations

1. Continue weed control.
2. Continue fertilization program in conjunction with weed control.
3. Brush out shoreline with ten foot strip from water to woodline.

CEDAR POINT - 2.0 acres; pH - 6.8; O<sub>2</sub> - 8 ppm; CO<sub>2</sub> - 10 ppm;  
871281  
Total hardness - 34.2; Temperature - 85°F;  
Average depth - 5 feet; Bloom - 35 inches

This pond was renovated in 1965, restocked with bass, bluegill and redear sunfish. Ten to twelve channel catfish were stocked in 1970. The pond was opened to fishing in 1967 and angling pressure is heavy and success has been good. The pond has been brushed around the edges for fishing and management access. Artificial spawning boxes have been placed on the bottom of the pond for reproduction of channel catfish.

Recommendations

1. Continue to fertilize and lime to continue bloom.
2. Continue present management practices.
3. Maintain artificial spawning boxes for channel catfish reproduction.

POWERLINE POND - 2.0 acres; pH - 6.5; O<sub>2</sub> - 8 ppm; CO<sub>2</sub> - 10 ppm;  
844290  
Total hardness - 51 ppm; Temperature - 85°F;  
Average depth - 3.0 feet; Bloom - 24 inches

This pond was renovated and restocked in 1968. The pond was opened in 1969 and has produced good bluegill fishing since that time. Aquatic weeds have been a problem in this pond but was corrected in 1973. Bass and bluegill have affected reproduction each year since this pond was renovated. Channel catfish were introduced in 1970 and artificial spawning boxes have been placed on the bottom of this pond.

Recommendations

1. Maintain proper water chemistry levels.
2. Continue fertilization and liming program.
3. Maintain spawning boxes for channel catfish.

COURTHOUSE BAY POND - 1.0 acres; pH - 6.5; O<sub>2</sub> - 4.0 ppm; CO<sub>2</sub> - 11 ppm;  
843291  
Total hardness - 51 ppm; Temperature - 80°F;  
Average depth - 3.5 feet; Bloom - Clear

This pond was renovated and restocked in 1968. The pond was opened to fishing in 1969 and produced good bluegill fishing until 1970. The pond is adjacent to an area used for training personnel in operating heavy equipment. These operators disturbed soil too close to the pond shoreline which has caused a serious erosion problem.

Recommendations

1. Continue liming and fertilization program.
2. Continue to reduce soil erosion.
3. If erosion control is not maintained, discontinue pond management.

OAK POND - .5 acres; pH - 6.4; O<sub>2</sub> - 2 ppm; CO<sub>2</sub> - 8 ppm;  
 888287 Total hardness - 34 ppm; Temperature - 85°F;  
 Average depth - 4 feet; Bloom - Clear

This pond was renovated in 1968 and stocked with channel catfish. This stocking was not successful and channel catfish were restocked in this pond in 1969. The pond was opened for fishing in 1970 and has produced fair angling since that time.

Recommendations

1. Continue fertilization and liming program.
2. Brush ten foot wide vista between water and woodline.
3. Maintain proper water chemistry levels.

NEW POND - 3.0 acres; pH - 8.5; O<sub>2</sub> - 6.0 ppm; CO<sub>2</sub> - 12 ppm;  
 856366 Total hardness - 34 - 51 ppm; Temperature - 84°F;  
 Average depth - 8 feet; Bloom - 0 - 12 inches

This pond was constructed during 1972 on the site of the open burning trash disposal area which was replaced with the New Sanitary Landfill. The pond is a part of the reclamation and beautification project at the old disposal site. NEW POND was stocked with 6 months - 2 years old bluegill and redear sunfish in March of 1973. Bass were stocked in June of 1973 and this pond was opened for fishing in September 1974 after the bass reproduced. Channel catfish were stocked in September 1973. Natural reproduction of channel catfish will be promoted through the placement of artificial spawning boxes.

Recommendations

1. Continue fertilization program.
2. Stock with 5,400 channel catfish.
3. Maintain proper water chemistry levels.
4. Open for fishing when bass reproduction is present.

NEW RIVER - pH -7.4; O<sub>2</sub> - 6.0 ppm; CO<sub>2</sub> - 11.0 ppm; Total Alkalinity  
 85 ppm; Temperature - 81°F; Average width - 3,675 feet;  
 Average depth - 2.1 feet; Mileage - 18; Bottom Type - Sand

This estuary is an important fishery area for salt water fish and shellfish in its lower reaches near the Atlantic Ocean. This estuarine area is also important as a nursery area for salt water species. The river is used for commercial fishing, crabbing oystering, clamming, shrimping and sports fishing. Water sports such as boating, water skiing and sailing are enjoyed by many people. The ecological classification of this river is tidal.

GAME FISH

Spot  
 Pigfish  
 Croaker

NONGAME FISH

Atlantic Menhaden  
 Bay Anchovy  
 Atlantic Silverside

AQUATIC VEGETATION

Bush  
 Marsh Grasses

GAME FISH

Southern Flounder  
Weakfish  
Bluefish

NONGAME FISH

Pinfish  
Stripped Killifish  
Stripped Mullet  
Green Goby  
Atlantic Needlefish

AQUATIC VEGETATION

SOUTHWEST CREEK - pH - 6.6; O<sub>2</sub> - 6.0 ppm; CO<sub>2</sub> - 12.0 ppm;  
Total Alkalinity - 28 ppm; Temperature - 80°F;  
Average width - 58 feet; Average depth - 7 feet;  
Mileage - 5.8; Bottom type - Sand

This creek supports an excellent population of fresh water game fishes. This stream receives heavy fishing pressure throughout the year. Local anglers enjoy fishing for spotted weakfish during fall and winter in the lower reaches. Further upstream waters provide good catches of redbreast, redear, bluegill and largemouth bass. Public access is available where roads cross the creek or at Maple and Marsden Landings. The ecological classification of this stream is largemouth - pickerel.

GAME FISH

Warmouth  
Redbreast  
Redear Sunfish  
Bluegill  
Pumpkinseed  
Chain Pickerel  
Redfin Pickerel  
Largemouth Bass  
Yellow Perch

NONGAME FISH

Yellow Bullhead  
Dusky Shinner  
Johnny Darter  
Comely Shiver  
Pirates Perch  
Banded Perch  
Lake Chubsucker  
Mosquito Fish  
American Eel

AQUATIC VEGETATION

Pickerelweed  
Waterweed  
Smartweed  
Coontail

NORTHEAST CREEK - pH - 6.5; O<sub>2</sub> - 4.4 ppm; CO<sub>2</sub> - 12.0 ppm;  
Total Alkalinity - 28 ppm; Temperature - 84°F;  
Average depth - 1.5 feet; Average width - 2,750 feet;  
Mileage - 3.6; Bottom type - Muck

This creek is a large tidal salt water bay. It is an unproductive fresh water fishing area although some fresh water species are present in the upper bay. This creek is an important nursery area for brackish water species. Much of this creek is shallow and is hazardous to navigation due to sand shoals. Boating access is from NC - 24 bridge or from New River by boat. Ecological classification is tidal.

GAME FISH

Pumpkinseed  
Chain Pickerel  
Redfin Pickerel  
Southern Flounder

NONGAME FISH

Atlantic Menhaden  
Tidewater Silverside  
Stripped Mullet  
Mosquito Fish  
Pinfish  
Green Goby  
Naked Goby  
Longnose Gar

AQUATIC VEGETATION

Rush  
Cattail  
Burred



GAME FISH

Southern Flounder  
Spot  
Croaker

NONGAME FISH

Atlantic Silverside  
Atlantic Menhaden  
Stripped Killifish  
Pigfish  
Stripped Mullet

AQUATIC VEGETATION

Rush  
Marsh Grasses  
Cattail  
Pickerelweed

BEAR CREEK - pH - 7.3; O<sub>2</sub> - 4.4 ppm; CO<sub>2</sub> - 10 ppm;  
Total Alkalinity - 98 ppm; Temperature - 76°F;  
Average width - 135 feet; Average depth - 2.5 feet;  
Mileage - 10.0; Bottom type - Muck - Shell

This creek is an important fishing and shell fishing stream. Boating access is from the Intracoastal Waterway. This stream between the Intracoastal Waterway and Bear Inlet is very productive for angling and shell fishing. The ecological classification is tidal.

GAME FISH

Southern Flounder  
Spot  
Croaker  
Black Sea Bass  
Bluefish  
Red Drum  
Black Drum  
Pigfish  
Pompano

NONGAME FISH

Tidewater Silverside  
Atlantic Mehaden  
Stripped Mullet  
Sand Perch  
Bay Anchovy  
Inshore Lizardfish  
Stripped Killifish  
Oyster Toadfish  
Northern Puffer

AQUATIC VEGETATION

Cattail  
Rush  
Marsh Grasses  
Kelp

DUCK CREEK - pH - 6.5; O<sub>2</sub> - 4.6 ppm; CO<sub>2</sub> - 13 ppm;  
Total Alkalinity - 85 ppm; Temperature - 85°F;  
Average width - 30 feet; Average depth - 1.5 feet;  
Mileage - 3.0; Bottom type - Muck

This creek is not a very productive fresh water fishing stream. Pumpkinseed and pickerel are caught in quantity periodically but fresh water fishing is sporadic. Weakfish and yearling red drum are taken in the fall but fishing is very light on this stream. Boating access is almost non-existent except by boat from New River. The classification of this stream is pickerel - pumpkinseed.

GAME FISH

Pumpkinseed  
Chain Pickerel  
Redfin Pickerel  
Spotted Weakfish  
Red Drum  
Southern Flounder

NONGAME FISH

Atlantic Silverside  
Pinfish  
Bay Anchovy  
Mosquito Fish  
Stripped Mullet  
American Eel

AQUATIC VEGETATION

Pondweed  
Cattail  
Marsh Grasses

GAME FISH

Southern Flounder  
Spot  
Black Sea Bass

NONGAME FISH

Atlantic Silverside  
Oyster Toadfish  
Inshore Lizardfish  
Atlantic Needlefish  
Northern Puffer  
Hogchoker

AQUATIC VEGETATION

Marsh Grasses  
Rush

GILLETTS CREEK - pH - 6.5; O<sub>2</sub> - 6.0 ppm; CO<sub>2</sub> - 11 ppm;  
Total Alkalinity - 91 ppm; Temperature - 82°F;  
Average width - 20 feet; Average depth - 1.2 feet;  
Mileage - 2.6; Bottom type - Muck

This creek is a small tidal stream which drains into the Intracoastal Waterway. It is not an important angling stream but is a good nursery area for salt water species. Clamming is productive in this stream. Access is by boat from the Intracoastal Waterway.

GAME FISH

Spot  
Croaker

NONGAME FISH

Atlantic Menhaden  
Bay Anchovy  
Tidewater Silverside  
Atlantic Silverside  
Stripped Mullet  
Mosquito Fish

AQUATIC VEGETATION

Marsh Grasses  
Rush

FREEMAN CREEK - pH - 7.4; O<sub>2</sub> - 6.0; CO<sub>2</sub> - 1.0 ppm;  
Total Alkalinity - 62 ppm; Temperature - 84°F;  
Average width - 50 feet; Average depth - 2.5 feet;  
Mileage - 3.0; Bottom type - Muck - Shell

This creek is a very important fishing and shell fishing creek. Boating access is from the Intracoastal Waterway or from Freeman Creek Landing. This creek receives heavy fishing pressure. Ecological classification is tidal.

GAME FISH

Southern Flounder  
Bluefish  
Croaker  
Spot  
Red Drum  
Weakfish  
Pigfish

NONGAME FISH

Northern Pipefish  
Northern Searobin  
Inshore Lizardfish  
Oyster Toadfish  
Northern Puffer

AQUATIC VEGETATION

Cattail  
Marsh Grasses  
Rush

BROWNS CREEK - pH - 6.9; O<sub>2</sub> - 2.0 ppm; CO<sub>2</sub> - 10 ppm;  
Total Alkalinity - 65 ppm; Temperature - 81°F;  
Average width - 75 feet; Average depth - 1.0 feet;  
Mileage - 1.2; Bottom type - Muck

This creek is an unimportant fishing stream as it lies between two live firing ranges which restricts boat traffic. This creek has an abundance of clam and oyster beds. The ecological classification is tidal.

GAME FISH

Pickereel  
Pumpkinseed  
Flounder  
Croaker  
Spot

NONGAME FISH

Atlantic Silverside  
Bay Anchovy  
Stripped Killifish  
Mosquito Fish  
Longnose Gar

AQUATIC VEGETATION

Pickereelweed  
Cattail  
Rush

SNEADS CREEK - pH - 7.9; O<sub>2</sub> - 7.0 ppm; CO<sub>2</sub> - 12.0 ppm;  
Total Alkalinity - 31 ppm; Temperature - 84°F;  
Average width - 225 feet; Average depth - 2.8 feet;  
Mileage - .7; Bottom type - Muck

This creek is an important commercial fishing creek. This creek also provides good angling for salt water species. Giggling of flounder is very productive in this creek. SNEADS CREEK can best be fished by boat from several landings at Sneads Ferry or from Courthouse Bay Boat-house. Ecological classification is tidal.

GAME FISH

Weakfish  
Southern Flounder  
Spot  
Croaker

NONGAME FISH

Atlantic Silverside  
Atlantic Menhaden  
Bay Anchovy  
Stripped Mullet  
Pinfish

AQUATIC VEGETATION

Marsh Grasses

TRAPS CREEK - pH - 6.5; O<sub>2</sub> - 6.0 ppm; CO<sub>2</sub> - 13 ppm;  
Total Alkalinity - 113 ppm; Temperature - 85°F;  
Average width - 40 feet; Average depth - 1.3;  
Mileage - 1.5; Bottom type - Muck - Shell

This creek is not an important angling stream except near its lower reaches. This creek empties into Traps Bay which is an important commercial fishing and shell fishing area. The creek produces good catches of flounder by angling and giggling. Small boats can be launched from natural launching sites at the mouth of the creek.

GAME FISH

Southern Flounder  
Spot  
Croaker

NONGAME FISH

Atlantic Silverside  
Stripped Mullet  
Atlantic Menhaden  
Bay Anchovy  
Pinfish  
Mosquito Fish

AQUATIC VEGETATION

Rush  
Marsh Grasses

HOLOVER CREEK - pH - 7.3; O<sub>2</sub> - 4.0 ppm; CO<sub>2</sub> - 12.0 ppm;  
Total Alkalinity - 85 ppm; Temperature - 78°F;  
Average width - 30 feet; Average depth - 1.0 feet;  
Mileage - 1.7; Bottom type - Muck

This creek is a small tidal stream which drains into Sallier's Bay. This stream is relatively unimportant as a fishing stream except near its mouth. Clamming and oystering is productive in this creek.

MILL CREEK - pH - 7.2; O<sub>2</sub> - 6.0 ppm; CO<sub>2</sub> - 8 ppm;  
 Total Alkalinity - 31 ppm; Temperature - 74°F;  
 Average width - 65 feet; Average depth - 1.3 feet;  
 Mileage - 2.5; Bottom type - Muck

This creek is an important nursery area for salt water species. This creek provides a good area for gigging flounder at night. This creek is only accessible by boat from New River.

<u>GAME FISH</u>	<u>NONGAME FISH</u>	<u>AQUATIC VEGETATION</u>
Chain Pickerel	Bay Anchovy	Pickerelweed
Southern Flounder	Pinfish	Cattail
Spotted Weakfish	Stripped Mullet	Marsh Grasses
Spot	American Eel	Rush

WHITEHURST CREEK - pH - 7.8; O<sub>2</sub> - 3.2; CO<sub>2</sub> - 16.0 ppm;  
 Total Alkalinity - 75 ppm; Temperature - 86°F;  
 Average width - 20 feet; Average depth - 1.5 feet;  
 Mileage - 2.0; Bottom type - Muck

This creek is not an important fishing stream as it receives little pressure because it drains a live firing area which usually prohibits fishermen from using this creek.

<u>GAME FISH</u>	<u>NONGAME FISH</u>	<u>AQUATIC VEGETATION</u>
Southern Flounder	Atlantic Silverside	Pickerelweed
Spot	Pinfish	Cattail
		Rush

TOWN CREEK - pH - 6.8; O<sub>2</sub> - 3.2; CO<sub>2</sub> - 8.0 ppm;  
 Total Alkalinity - 85 ppm; Temperature - 86°F;  
 Average width - 30 feet; Average depth - 1.8 feet;  
 Mileage - 2.0; Bottom type - Muck

This creek is a relatively unimportant creek for fishing. This creek is more useful as a nursery area for salt water species. This stream is historically significant because it is the site of the first permanent settlement of the area. This settlement was established near the mouth of the creek in 1752. Ecological classification is tidal.

<u>GAME FISH</u>	<u>NONGAME FISH</u>	<u>AQUATIC VEGETATION</u>
Spotted Weakfish	Atlantic Silverside	Cattail
Spot	Atlantic Needlefish	Rush
Croaker	Mosquito Fish	
	Longnose Gar	

LEWIS CREEK - pH - 6.2; O<sub>2</sub> - 3.1 ppm; CO<sub>2</sub> - 18.0 ppm;  
 Total Alkalinity - 28 ppm; Temperature - 79°F;  
 Average width - 40 feet; Average depth - 1.5 feet;  
 Mileage - 2.5; Bottom type - Muck

This creek is inaccessible except by boat from New River. Fishing for salt water game fish is productive near its influx with New River. Croaker fishing is very good in this area and some weakfish are taken in the fall. The ecological classification is pickerel - pumpkinseed.

GAME FISH

Spotted Weakfish  
Southern Flounder

NONGAME FISH

Atlantic Menhaden  
Tidewater Silverside  
Stripped Mullet  
Mosquito Fish  
Pinfish

AQUATIC VEGETATION

Rush  
Marsh Grasses

STONE CREEK - pH - 6.4; O<sub>2</sub> - 4.2 ppm; CO<sub>2</sub> - 11 ppm;  
Total Alkalinity - 80 ppm; Temperature - 79°F;  
Average depth - 2.5 feet; Average width - 65 feet;  
Mileage - 5.3; Bottom type - Muck

This creek is a black water creek that drains a large pocosin area. The water has a turbid appearance from the suspension of peat particles caused from run off over soils with high organic content. Pickerel is the only fresh water species in this creek. Weakfish and flounder fishing is very good during the fall. Boating access is from a ramp at the Rifle Range.

GAME FISH

Redfin  
Spotted Weakfish  
Southern Flounder

NONGAME FISH

Coastal Shinner  
Atlantic Menhaden  
Mosquito Fish  
Atlantic Needlefish

AQUATIC VEGETATION

Rush  
Marsh Grasses

MILLSTONE CREEK - pH - 7.2; O<sub>2</sub> - 4.4 ppm; CO<sub>2</sub> - 10.0 ppm;  
Total Alkalinity - 22 ppm; Temperature - 77°F;  
Average width - 15 feet; Average depth - 1-5 feet;  
Mileage - 1.8; Bottom type - Muck

This creek is an unimportant fishing stream. Seasonal sports fishing is confined to salt water species. Ecological classification is tidal.

GAME FISH

Southern Flounder  
Spot

NONGAME FISH

Bay Anchovy  
Atlantic Silverside  
Atlantic Menhaden  
Mosquito Fish

AQUATIC VEGETATION

Rush  
Marsh Grasses

MUDDY CREEK - pH - 7.7; O<sub>2</sub> - 5 ppm; CO<sub>2</sub> - 13 ppm;  
Total Alkalinity - 78 ppm; Temperature - 85°F;  
Average width - 20 feet; Average depth - 1.6 feet

This creek is a good fishing stream for salt water fish. Flounder fishing is very productive using live bait or by giggering at night. This creek is an important nursery area for salt water fish. Access is from New River by boat. The ecological classification is tidal.

GAME FISH

Chain Pickerel  
Southern Flounder  
Spotted Weakfish  
Spot

NONGAME FISH

Bay Anchovy  
Pinfish  
Stripped Mullet  
American Eel

AQUATIC VEGETATION

Pickerelweed  
Cattail  
Marsh Grasses  
Rush

WALLACE CREEK - pH - 7.8; O<sub>2</sub> - 4.2 ppm; CO<sub>2</sub> - 12.0 ppm;  
 Total Alkalinity - 75 ppm; Temperature - 78°F;  
 Average depth - 3 feet; Average width - 85 feet;  
 Mileage - 7.0; Bottom type - Silt - Muck

This creek is a productive stream for fresh water fishing above Holcomb Boulevard. The lower reaches of the stream provides the angler with the opportunity to catch pumpkinseed and weakfish during certain periods of the year. This stream is very important as a recreation area for canoeing and boating. Boating access is provided through the Wallace Creek Boathouse or from New River. Ecological classification is largemouth - pickerel.

<u>GAME FISH</u>	<u>NONGAME FISH</u>	<u>AQUATIC VEGETATION</u>
Chain Pickerel	Atlantic Menhaden	Cattail
Redbreast	Stripped Mullet	Coontail
Largemouth Bass	Pinfish	Pickerelweed
Redfin Pickerel	Dusky Shinner	Waterweed
	Yellow Bullhead	
	Mosquito Fish	

FRENCH CREEK - pH - 6.8; O<sub>2</sub> - 5.8 ppm; CO<sub>2</sub> - 18.0 ppm;  
 Total Alkalinity - 48 ppm; Temperature - 83°F;  
 Average depth - 2.5 feet; Average width - 550 feet;  
 Mileage - 3.3; Bottom type -

This creek is a relatively unproductive fishing stream for fresh water species. Fishing for pumpkinseed is productive and pickerel fishing is productive further upstream. Local anglers fish the stream in fall and winter when fishing for weakfish is very productive. A small pier has been constructed in one of the best locations in the stream for anglers. Boating access is from a natural boat landing near the pier. The ecological classification of this stream is pickerel - pumpkinseed.

<u>GAME FISH</u>	<u>NONGAME FISH</u>	<u>AQUATIC VEGETATION</u>
Pumpkinseed	Atlantic Mehaden	Rush
Chain Pickerel	Tidewater Silverside	Marsh Grasses
Redfin Pickerel	Pinfish	
Spotted Weakfish	Bluespotted Sunfish	
Red Drum	Bay Anchovy	
	Yellow Jack	

EVERETT CREEK - pH - 7.2; O<sub>2</sub> - 6.0 ppm; CO<sub>2</sub> - 10 ppm;  
 Total Alkalinity - 80 ppm; Temperature - 84°F;  
 Average width - 55 feet; Average depth - 1.5 feet;  
 Mileage - 2.3; Bottom type - Muck - Shell

This creek is a small salt water stream which is important as shell fishing area. Angling for flounder with live bait is very productive. There is no boating access on this stream except by boat from New River. The ecological classification of this stream is tidal.

T.

## FOREST-WIDE WILDLIFE HABITAT INVENTORY DATA SHEET

Wildlife Unit Number 1

1. Base Forest Montford Point	2. State North Carolina	3. County Onslow	4. Date of Invntry 7 May 1974	5. Invntry Team Wildlife Management Personnel
6. Aerial Photo Nos. 4-6, 189-190, 212-213 235-237, 322-323		7. Annual Work Projects: Continuing - C, Planned - P, Estimated Costs C-Seed one wildlife food plot to annual winter grains. Est. Cost \$100.00 annually. P-Seed one mile of forest access road to perennial grasses. Est. Cost \$210.00		
8. <u>Land Use</u>	<u>Acres</u>	9. Present Wildlife Populations - Trends (Pop.: High-H, Medium-M, Low-L Trend: Increase-I, Stationary-S, Decreasing-D)		
A. Military	<u>3,385</u>			
B. Hunting	<u>1,915</u>			
C. Fishing	<u>      </u>			
D. Forest Mgmt.	<u>1,915</u>			
E.	<u>      </u>			
F.	<u>      </u>			
G.	<u>      </u>			
Total Acres	<u>3,385</u>			
		<u>Pop.</u>	<u>Trend</u>	<u>Pop.</u>
		A. Deer	M S	G. Woodcock
		B. Turkey	L D	H. Rail
		C. Bear		I. Rabbit
		D. Squirrel	M S	J. Wood duck
		E. Quail	L I	K.
		F. Dove	M S	L.

10. Summarize Timber Conditions. Consider forest types, stand age, classes, including interpersions, mast conditions, sites, past timber mgmt, trend based on timber. Summarize other habitat types. Consider quality, use, crop rotation, etc.

<u>Forest Types</u>	<u>Acreage</u>	<u>No./Stands</u>	<u>Other Habitat Types</u>	<u>Acreage</u>
A. Longleaf Pine	<u>      </u>	<u>      </u>	H. Wildlife Food Plots	<u>6.2</u>
B. Loblolly Pine	<u>1,289</u>	<u>14</u>	I. Small Game Strips	<u>0</u>
C. Loblolly Pine-Hardwood	<u>184</u>	<u>3</u>	J. Wildlife Openings	<u>0</u>
D. Pond Pine	<u>      </u>	<u>      </u>	K. Tactical Landing Zones	<u>0</u>
E. Oak-Hickory	<u>      </u>	<u>      </u>	L. Explosive Ord. Impact Area	<u>      </u>
F. Cypress-Tupelo	<u>      </u>	<u>      </u>	M. Marsh	<u>      </u>
G. Bottomland Hardwoods	<u>442</u>	<u>5</u>	N. Tidelands	<u>      </u>
			O. Housing-Industrial	<u>555</u>

11. Summarize Understory Vegetative Conditions. List major vegetative species, browse availability, abundance of fruit and mast producers, browse utilized, cover and other data for wildlife species.

<u>Fruit/Mast Trees</u>	<u>Shrubs/Vines</u>	<u>Herbaceous Plants</u>	<u>Evergreen Cover</u>	<u>Available Browse</u>
Poor <u>      </u>	Poor <u>      </u>	Scarce <u>      </u>	Poor <u>      </u>	Poor <u>      </u>
Fair <u>X</u>	Fair <u>      </u>	Moderate <u>      </u>	Fair <u>      </u>	Fair <u>      </u>
Good <u>      </u>	Good <u>X</u>	Abundant <u>X</u>	Good <u>X</u>	Good <u>X</u>

Browse Utilization

Light         
Moderate X  
Heavy       

COMMENTS:

Timber operations during FY 70-71 has improved availability of understory vegetation.

12. Featured Wildlife Species of Wildlife Unit by priority. Select by (1) - Habitat and User Demand.

Deer will be featured within this unit.

13. Present Improvements:

A. Openings	No.	Acreage/ Mileage
1. Sod		
2. Planted	1	7.7 a
3. Access Roads	21	9.9 mi
4. Seed-tree Cuts	2	125.0 a
5. Clear Cuts	3	7.7 a
6. Old Homesites	3	1.5 a
B. Shrub Plantings		
C. Power Lines	1	2.25mi
D. Firing Ranges		

14. Ponds, Impoundments, Wetlands  
(Existing - E) (Proposed - P)

Name	Acreage	Fish	Waterfowl
_____	_____	_____	_____
_____	_____	_____	_____
_____	_____	_____	_____
_____	_____	_____	_____
_____	_____	_____	_____
_____	_____	_____	_____
_____	_____	_____	_____
_____	_____	_____	_____
_____	_____	_____	_____
_____	_____	_____	_____

15. Streams. (Length - L) (Average Width - W)

Name	L	W	Fresh	Salt	Species
Northeast	3.6	2.750 ft.	_____	X	Sf-Ng
_____	_____	_____	_____	_____	_____
_____	_____	_____	_____	_____	_____
_____	_____	_____	_____	_____	_____
_____	_____	_____	_____	_____	_____
_____	_____	_____	_____	_____	_____

16. Limiting Factors:

	Deer	Turkey	Squirrel	Bear	Quail	Dove	Rabbit	Wood Duck
1. Openings	X	_____	_____	_____	_____	_____	_____	_____
2. Food	_____	_____	_____	_____	_____	_____	_____	_____
3. Cover	_____	_____	_____	_____	_____	_____	_____	_____
4. Dogs	_____	_____	_____	_____	_____	_____	_____	_____
5. Poaching	_____	_____	_____	_____	_____	_____	_____	_____
6. Under Harvest	_____	_____	_____	_____	_____	_____	_____	_____

17. Recommendations to improve limiting factors. Work plans, est. costs, mileage, acreage, etc., needed. Emphasize key areas.

Clear one additional wildlife food plot. Establish to winter grains. Est. Cost - \$185.00

18. Summarize Acres of Habit by Species.

Species	Acres	Species	Acres
1. Deer	2,230	6. Dove	2,028
2. Turkey	_____	7. Woodcock	1,915
3. Bear	624	8. Rail	_____
4. Squirrel	1,473	9. Wood Duck	626
5. Quail	2,028		



FOREST-WIDE WILDLIFE HABITAT INVENTORY DATA SHEET

Wildlife Unit Number 2

1. Base Forest Paradise Point	2. State North Carolina	3. County Onslow	4. Date of Invntry 8 May 1974	5. Invntry Team Wildlife Management Personnel																																																												
6. Aerial Photo Nos. 145-147, 163-171, 191-197 214-216		7. Annual Work Projects: Continuing - C, Planned - P, Estimated Costs C-Seed three food plots to winter grains. Est. Cost annually \$300.00. P-Seed two miles of forest access roads. Est. Cost - \$420.00.																																																														
8. Land Use		9. Present Wildlife Populations - Trends (Pop.: High-H, Medium-M, Low-L Trend: Increase-I, Stationary-S, Decreasing-D)																																																														
<table border="1"> <thead> <tr> <th>Land Use</th> <th>Acres</th> </tr> </thead> <tbody> <tr><td>A. Military</td><td>3,157</td></tr> <tr><td>B. Hunting</td><td>2,634</td></tr> <tr><td>C. Fishing</td><td></td></tr> <tr><td>D. Forest Mgmt.</td><td>2,634</td></tr> <tr><td>E. Nature Study</td><td>280</td></tr> <tr><td>F. Scouting</td><td>396</td></tr> <tr><td>G. Golfing</td><td>483</td></tr> <tr><td>Total Acres</td><td>3,157</td></tr> </tbody> </table>		Land Use	Acres	A. Military	3,157	B. Hunting	2,634	C. Fishing		D. Forest Mgmt.	2,634	E. Nature Study	280	F. Scouting	396	G. Golfing	483	Total Acres	3,157	<table border="1"> <thead> <tr> <th></th> <th>Pop.</th> <th>Trend</th> <th></th> <th>Pop.</th> <th>Trend</th> </tr> </thead> <tbody> <tr><td>A. Deer</td><td>H</td><td>T</td><td>G. Woodcock</td><td>H</td><td>S</td></tr> <tr><td>B. Turkey</td><td>L</td><td>S</td><td>H. Rail</td><td></td><td></td></tr> <tr><td>C. Bear</td><td>L</td><td>S</td><td>I. Rabbit</td><td>M</td><td>S</td></tr> <tr><td>D. Squirrel</td><td>H</td><td>S</td><td>J. Wood duck</td><td>M</td><td>I</td></tr> <tr><td>E. Quail</td><td>M</td><td>S</td><td>K.</td><td></td><td></td></tr> <tr><td>F. Dove</td><td>M</td><td>S</td><td>L.</td><td></td><td></td></tr> </tbody> </table>				Pop.	Trend		Pop.	Trend	A. Deer	H	T	G. Woodcock	H	S	B. Turkey	L	S	H. Rail			C. Bear	L	S	I. Rabbit	M	S	D. Squirrel	H	S	J. Wood duck	M	I	E. Quail	M	S	K.			F. Dove	M	S	L.		
Land Use	Acres																																																															
A. Military	3,157																																																															
B. Hunting	2,634																																																															
C. Fishing																																																																
D. Forest Mgmt.	2,634																																																															
E. Nature Study	280																																																															
F. Scouting	396																																																															
G. Golfing	483																																																															
Total Acres	3,157																																																															
	Pop.	Trend		Pop.	Trend																																																											
A. Deer	H	T	G. Woodcock	H	S																																																											
B. Turkey	L	S	H. Rail																																																													
C. Bear	L	S	I. Rabbit	M	S																																																											
D. Squirrel	H	S	J. Wood duck	M	I																																																											
E. Quail	M	S	K.																																																													
F. Dove	M	S	L.																																																													

10. Summarize Timber Conditions. Consider forest types, stand age, classes, including inter-spersion, mast conditions, sites, past timber mgmt, trend based on timber. Summarize other habitat types. Consider quality, use, crop rotation, etc.

Forest Types	Acreeage	No./Stands	Other Habitat Types	Acreeage
A. Longleaf Pine			H. Wildlife Food Plots	15.5
B. Loblolly Pine	1,954	17	I. Small Game Strips	0
C. Loblolly Pine-Hardwood	448	8	J. Wildlife Openings	2
D. Pond Pine			K. Tactical Landing Zones	4
E. Oak-Hickory	52	1	L. Explosive Ord. Impact Area	
F. Cypress-Tupelo			M. Marsh	
G. Bottomland Hardwoods	180	4	N. Tidelands	
			O. Housing-Industrial	776

11. Summarize Understory Vegetative Conditions. List major vegetative species, browse availability, abundance of fruit and mast producers, browse utilized, cover and other data for wild-life species.

Fruit/Mast Trees	Shrubs/Vines	Herbaceous Plants	Evergreen Cover	Available Browse
Poor _____	Poor <u>X</u>	Scarce <u>X</u>	Poor _____	Poor <u>X</u>
Fair <u>X</u>	Fair _____	Moderate _____	Fair _____	Fair _____
Good _____	Good _____	Abundant _____	Good <u>X</u>	Good _____

Browse Utilization

Light \_\_\_\_\_

Moderate \_\_\_\_\_

Heavy X

COMMENTS:

Timber operations during FY 72-73 improved understory vegetative conditions. Either sex deer hunts were conducted during FY 74 to improve herd productivity.

12. Featured Wildlife Species of Wildlife Unit by priority. Select by (1) - Habitat and User Demand.

Deer will be featured in this unit.

13. Present Improvements:

A. Openings	No.	Acreage/ Mileage
1. Sod	2	1.5
2. Planted	3	8.0
3. Access Roads	20	9.6 mi
4. Seed-tree Cuts	1	.45
5. Clear Cuts		
6. Old Homesites	3	1.5
B. Shrub Plantings	1	.4
C. Power Lines	1	.75 mi
D. Firing Ranges		

14. Ponds, Impoundments, Wetlands  
(Existing - E) (Proposed - P)

Name	Acreage	Fish	Waterfowl
_____	_____	_____	_____
_____	_____	_____	_____
_____	_____	_____	_____
_____	_____	_____	_____
_____	_____	_____	_____
_____	_____	_____	_____
_____	_____	_____	_____
_____	_____	_____	_____
_____	_____	_____	_____
_____	_____	_____	_____

15. Streams. (Length - L) (Average Width - W)

Name	L	W	Fresh	Salt	Species
Wallace	3.0 mi	85 ft.	X		Im-df-Cp
Northeast	3.6 mi	2,750 ft.		X	Sf-Ng
_____	_____	_____	_____	_____	_____
_____	_____	_____	_____	_____	_____
_____	_____	_____	_____	_____	_____
_____	_____	_____	_____	_____	_____

16. Limiting Factors: Deer Turkey Squirrel Bear Quail Dove Rabbit Wood Duck

1. Openings	_____	_____	_____	_____	_____	_____	_____	_____
2. Food	_____	_____	_____	_____	_____	_____	_____	_____
3. Cover	_____	_____	_____	_____	_____	_____	_____	_____
4. Dogs	_____	_____	_____	_____	_____	_____	_____	_____
5. Poaching	_____	_____	_____	_____	_____	_____	_____	_____
6. Under Harvest	X	_____	_____	_____	_____	_____	_____	_____

17. Recommendations to improve limiting factors. Work plans, est. costs, mileage, acreage, etc., needed. Emphasize key areas.

Harvest of deer in this unit will be increased and will be accomplished through organized hunts at no cost.

18. Summarize Acres of Habit by Species.

Species	Acres	Species	Acres
1. Deer	2,634	6. Dove	2,454
2. Turkey	2,454	7. Woodcock	2,634
3. Bear	680	8. Rail	_____
4. Squirrel	2,454	9. Wood Duck	680
5. Quail	2,454		

FOREST-WIDE WILDLIFE HABITAT INVENTORY DATA SHEET

Wildlife Unit Number 3

1. Base Forest Hadnot Point	2. State North Carolina	3. County Onslow	4. Date of Invnry 28 May 1974	5. Invnry Team Wildlife Management Personnel
--------------------------------	----------------------------	---------------------	----------------------------------	---

6. Aerial Photo Nos.  
145-147, 167-170, 195-196

7. Annual Work Projects: Continuing - C, Planned - P, Estimated Costs  
 C-Seed two wildlife food plots to winter grains. Est. Cost \$200.00  
 P-Plant one mile of forest access road to perennial grasses. Estimated Cost - \$210.00.

8. <u>Land Use</u>	<u>Acres</u>	9. Present Wildlife Populations - Trends (Pop.: High-H, Medium-M, Low-L Trend: Increase-I, Stationary-S, Decreasing-D)			
A. Military	<u>4,603</u>				
B. Hunting	<u>2,342</u>				
C. Fishing	<u>18</u>				
D. Forest Mgmt.	<u>2,342</u>				
E.	_____				
F.	_____				
G.	_____				
Total Acres	<u>4,603</u>				

	Pop.	Trend		Pop.	Trend
A. Deer	H	I	G. Woodcock	H	S
B. Turkey	L	S	H. Rail	_____	_____
C. Bear	L	S	I. Rabbit	L	S
D. Squirrel	H	S	J. Wood duck	M	I
E. Quail	M	S	K. Raccoon	H	I
F. Dove	M	S	L. Otter	M	S

10. Summarize Timber Conditions. Consider forest types, stand age, classes, including interpersions, mast conditions, sites, past timber mgmt, trend based on timber. Summarize other habitat types. Consider quality, use, crop rotation, etc.

<u>Forest Types</u>	<u>Acreege</u>	<u>No./Stands</u>	<u>Other Habitat Types</u>	<u>Acreege</u>
A. Longleaf Pine	_____	_____	H. Wildlife Food Plots	<u>12.4</u>
B. Loblolly Pine	<u>1,431</u>	<u>8</u>	I. Small Game Strips	_____
C. Loblolly Pine-Hardwood	<u>584</u>	<u>6</u>	J. Wildlife Openings	_____
D. Pond Pine	_____	_____	K. Tactical Landing Zones	_____
E. Oak-Hickory	<u>37</u>	<u>1</u>	L. Explosive Ord. Impact Area	_____
F. Cypress-Tupelo	_____	_____	M. Marsh	_____
G. Bottomland Hardwoods	<u>290</u>	<u>4</u>	N. Tidelands	_____
			O. Housing-Industrial	<u>2,015</u>

11. Summarize Understory Vegetative Conditions. List major vegetative species, browse availability, abundance of fruit and mast producers, browse utilized, cover and other data for wildlife species.

<u>Fruit/Mast Trees</u>	<u>Shrubs/Vines</u>	<u>Herbaceous Plants</u>	<u>Evergreen Cover</u>	<u>Available Browse</u>
Poor _____	Poor _____	Scarce _____	Poor _____	Poor _____
Fair <u>X</u> _____	Fair _____	Moderate <u>X</u> _____	Fair _____	Fair _____
Good _____	Good <u>X</u> _____	Abundant _____	Good <u>X</u> _____	Good <u>X</u> _____

Browse Utilization

Light \_\_\_\_\_

Moderate \_\_\_\_\_

Heavy X \_\_\_\_\_

COMMENTS:

Timber operations during FY 71-72 improved browse in understory. Either sex hunt was conducted during FY-74 to improve herd productivity.

12. Featured Wildlife Species of Wildlife Unit by priority. Select by (1) - Habitat and User Demand.

Deer will be featured in this unit. Osprey nesting sites in this unit will receive prime consideration.

13. Present Improvements:

A. Openings	No.	Acreage/ Mileage
1. Sod	1	2.0 a
2. Planted	2	5.0 a
3. Access Roads	18	5.4 mi
4. Seed-tree Cuts		
5. Clear Cuts		
6. Old Homesites	4	2.0 a
B. Shrub Plantings	1	.25 a
C. Power Lines	1	.85 mi
D. Firing Ranges		

14. Ponds, Impoundments, Wetlands  
(Existing - E) (Proposed - P)

Name	Acreage	Fish	Waterfowl
New Pond	3.0	LB-BG	

15. Streams. (Length - L) (Average Width - W)

Name	L	W	Fresh	Salt	Species
Frenchs Ck.	3.3 mi	550 ft.	X	X	Pf-Cp
Wallace Ck.	3.0 mi	2,750 ft.	X		Im-Pf-Cp

16. Limiting Factors: Deer Turkey Squirrel Bear Quail Dove Rabbit Wood Duck

1. Openings								
2. Food								
3. Cover								
4. Dogs								
5. Poaching								
6. Under Harvest	X							

17. Recommendations to improve limiting factors. Work plans, est. costs, mileage, acreage, etc., needed. Emphasize key areas.

The deer population should reduce through hunting which can be accomplished at no cost. Manage fresh water fish in the pond in this unit. Est. Cost \$226.00.

18. Summarize Acres of Habit by Species.

Species	Acres	Species	Acres
1. Deer	2,342	6. Dove	2,052
2. Turkey	2,052	7. Woodcock	2,342
3. Bear	911	8. Rail	
4. Squirrel	2,052	9. Wood Duck	911
5. Quail	2,052		

FOREST-WIDE WILDLIFE HABITAT INVENTORY DATA SHEET

Wildlife Unit Number 4

1. Base Forest Starrets Meadow	2. State North Carolina	3. County Onslow	4. Date of Invntry 29 May 1974	5. Invntry Team Wildlife Management Personnel			
6. Aerial Photo Nos. 74-77, 113-117, 140-144, 289-293		7. Annual Work Projects: Continuing - C, Planned - P, Estimated Costs C-Seed twelve food plots to winter grains. Est. Cost \$1,200.00. Seed one mile of forest access road to perennial grasses. \$210.00.					
8. Land Use	Acres	9. Present Wildlife Populations - Trends (Pop.: High-H, Medium-M, Low-L Trend: Increase-I, Stationary-S, Decreasing-D)					
A. Military	<u>10,399</u>	Pop.	Trend	Pop.	Trend		
B. Hunting	<u>10,136</u>	A. Deer	M	I	G. Woodcock	M	S
C. Fishing	<u>18</u>	B. Turkey	H	S	H. Rail		
D. Forest Mgmt.	<u>10,093</u>	C. Bear	M	I	I. Rabbit	L	S
E.		D. Squirrel	M	S	J. Wood duck	M	I
F.		E. Quail	M	S	K. Raccoon	H	I
G.		F. Dove	M	S	L. Otter	M	S
Total Acres	<u>10,899</u>						

10. Summarize Timber Conditions. Consider forest types, stand age, classes, including interspersion, mast conditions, sites, past timber mgmt, trend based on timber. Summarize other habitat types. Consider quality, use, crop rotation, etc.

Forest Types	Acreeage	No./Stands	Other Habitat Types	Acreeage
A. Longleaf Pine	<u>1,391</u>	<u>20</u>	H. Wildlife Food Plots	<u>82.5</u>
B. Loblolly Pine	<u>6,043</u>	<u>68</u>	I. Small Game Strips	<u>7.8</u>
C. Loblolly Pine-Hardwood	<u>54</u>	<u>2</u>	J. Wildlife Openings	<u>34.5</u>
D. Pond Pine	<u>1,118</u>	<u>19</u>	K. Tactical Landing Zones	<u>102.7</u>
E. Oak-Hickory	<u>112</u>	<u>3</u>	L. Explosive Ord. Impact Area	
F. Cypress-Tupelo			M. Marsh	
G. Bottomland Hardwoods	<u>1,375</u>	<u>22</u>	N. Tidelands	
			O. Housing-Industrial	<u>163</u>

11. Summarize Understory Vegetative Conditions. List major vegetative species, browse availability, abundance of fruit and mast producers, browse utilized, cover and other data for wildlife species.

Fruit/Mast Trees	Shrubs/Vines	Herbaceous Plants	Evergreen Cover	Available Browse
Poor _____	Poor _____	Scarce _____	Poor _____	Poor _____
Fair _____	Fair _____	Moderate _____	Fair _____	Fair _____
Good <u>X</u>	Good <u>X</u>	Abundant <u>X</u>	Good <u>X</u>	Good <u>X</u>

Browse Utilization

Light \_\_\_\_\_  
 Moderate \_\_\_\_\_  
 Heavy X

COMMENTS:

Availability of understory vegetation is very good. Recent timber operations improved understory conditions.

12. Featured Wildlife Species of Wildlife Unit by priority. Select by (1) - Habitat and User Demand. Wild turkey will be featured in this unit. Nesting sites of osprey will receive special protection in this unit. The red-cockaded woodpecker & American alligator inhabits this unit.

13. Present Improvements:

A. Openings	No.	Acreage/ Mileage
1. Sod	17	8.5 a
2. Planted	11	33.0 a
3. Access Roads	26	25.4 mi
4. Seed-tree Cuts	3	125.0 a
5. Clear Cuts	1	40.0 a
6. Old Homesites	8	4.0 a
B. Shrub Plantings	4	.5 a
C. Power Lines		
D. Firing Ranges	8	154.0

14. Ponds, Impoundments, Wetlands  
(Existing - E) (Proposed - P)

Name	Acreage	Fish	Waterfowl
Hickory	3.0	Lm-Pf	
Henderson	15.0	Lm-Pf	

15. Streams. (Length - L) (Average Width - W)

Name	L	W	Fresh	Salt	Species
Wallace Ck.	4.0	4 ft	X		Lm-Pf-Cp

16. Limiting Factors: Deer Turkey Squirrel Bear Quail Dove Rabbit Wood Duck

1. Openings								
2. Food								
3. Cover								
4. Dogs								
5. Poaching	x							
6. Under Harvest								

17. Recommendations to improve limiting factors. Work plans, est. costs, mileage, acreage, etc., needed. Emphasize key areas.

Some poaching exist along roadways in this unit. Increased patrolling of the area by protection units should correct this limiting factor.

18. Summarize Acres of Habit by Species.

Species	Acres	Species	Acres
1. Deer	10,093	6. Dove	7,600
2. Turkey	7,600	7. Woodcock	7,584
3. Bear	2,659	8. Rail	
4. Squirrel	7,600	9. Wood Duck	1,541
5. Quail	7,600		

FOREST-WIDE WILDLIFE HABITAT INVENTORY DATA SHEET

Wildlife Unit Number 5

1. Base Forest Mossy Pond Pocosin	2. State North Carolina	3. County Onslow	4. Date of Invntry 30 May 1974	5. Invntry Team Wildlife Management Personnel
---	-------------------------------	---------------------	-----------------------------------	---

6. Aerial Photo Nos. 78-80, 99-107, 117-125, 294-298, 259-261	7. Annual Work Projects: Continuing - C, Planned - P, Estimated Costs C-Plant twelve food plots to winter grains. Est. Cost \$1,200.00. P-Plant forty-eight small game strips to annual grains. Est. Cost \$1,150.00.
---	--

8. <u>Land Use</u>	<u>Acres</u>	9. Present Wildlife Populations - Trends (Pop.: High-H, Medium-M, Low-L Trend: Increase-I, Stationary-S, De- creasing-D)			
A. Military	<u>10,689</u>				
B. Hunting	<u>9,088</u>				
C. Fishing	_____				
D. Forest Mgmt.	<u>8,842</u>				
E.	_____				
F.	_____				
G.	_____				
Total Acres	<u>10,689</u>				

	<u>Pop.</u>	<u>Trend</u>		<u>Pop.</u>	<u>Trend</u>
A. Deer	<u>M</u>	<u>I</u>	G. Woodcock	<u>L</u>	<u>S</u>
B. Turkey	<u>H</u>	<u>S</u>	H. Rail	_____	_____
C. Bear	<u>M</u>	<u>I</u>	I. Rabbit	<u>L</u>	<u>S</u>
D. Squirrel	<u>M</u>	<u>S</u>	J. Wood duck	<u>L</u>	<u>I</u>
E. Quail	<u>M</u>	<u>I</u>	K. Otter	<u>M</u>	<u>S</u>
F. Dove	<u>M</u>	<u>I</u>	L.	_____	_____

10. Summarize Timber Conditions. Consider forest types, stand age, classes, including inter-  
spersion, mast conditions, sites, past timber mgmt, trend based on timber. Summarize other  
habitat types. Consider quality, use, crop rotation, etc.

<u>Forest Types</u>	<u>Acreege</u>	<u>No./Stands</u>	<u>Other Habitat Types</u>	<u>Acreege</u>
A. Longleaf Pine	<u>3,106</u>	<u>35</u>	H. Wildlife Food Plots	<u>52.9</u>
B. Loblolly Pine	<u>3,542</u>	<u>43</u>	I. Small Game Strips	<u>12</u>
C. Loblolly Pine-Hardwood	<u>564</u>	<u>7</u>	J. Wildlife Openings	<u>12</u>
D. Pond Pine	<u>1,065</u>	<u>18</u>	K. Tactical Landing Zones	<u>133.8</u>
E. Oak-Hickory	_____	_____	L. Explosive Ord. Impact Area	<u>2,184</u>
F. Cypress-Tupelo	_____	_____	M. Marsh	<u>342</u>
G. Bottomland Hardwoods	<u>565</u>	<u>15</u>	N. Tidelands	<u>916</u>
			O. Housing-Industrial	<u>42</u>

11. Summarize Understory Vegetative Conditions. List major vegetative species, browse avail-  
ability, abundance of fruit and mast producers, browse utilized, cover and other data for wild-  
life species.

<u>Fruit/Mast Trees</u>	<u>Shrubs/Vines</u>	<u>Herbaceous Plants</u>	<u>Evergreen Cover</u>	<u>Available Browse</u>
Poor _____	Poor _____	Scarce _____	Poor _____	Poor _____
Fair <u>X</u>	Fair _____	Moderate _____	Fair _____	Fair _____
Good _____	Good <u>X</u>	Abundant <u>X</u>	Good <u>X</u>	Good <u>X</u>

Browse Utilization

Light \_\_\_\_\_  
Moderate X  
Heavy \_\_\_\_\_

COMMENTS:

Prescribed burning in this unit is improving  
understory plant production and tends to im-  
prove available quail habitat.

12. Featured Wildlife Species of Wildlife Unit by priority. Select by (1) - Habitat and User Demand. Bobwhite quail will be featured in this unit. The endangered red-cockaded woodpecker and American alligator inhabits this unit.

13. Present Improvements:

A. Openings	No.	Acreage/ Mileage
1. Sod	24	6. a
2. Planted	33	61. a
3. Access Roads	33	25.5 mi
4. Seed-tree Cuts	1	25. a
5. Clear Cuts	1	45.0 a
6. Old Homesites	7	3.5 a
B. Shrub Plantings	8	1.2 a
C. Power Lines		
D. Firing Ranges	5	273.9

14. Ponds, Impoundments, Wetlands  
(Existing - E) (Proposed - P)

Name	Acreage	Fish	Waterfowl
Mossy	9.3		Wood duck

15. Streams. (Length - L) (Average Width - W)

Name	L	W	Fresh	Salt	Species
Freeman	3.0	2.5		X	Sf-St-Bf
Browns				X	Sf-Ng

16. Limiting Factors: Deer Turkey Squirrel Bear Quail Dove Rabbit Wood Duck

1. Openings								
2. Food								
3. Cover								
4. Dogs								
5. Poaching	x							
6. Under Harvest								

17. Recommendations to improve limiting factors. Work plans, est. costs, mileage, acreage, etc., needed. Emphasize key areas.

Poaching is a problem at times along some roadways in this area. Increased patrolling will improve this limiting factor.

18. Summarize Acres of Habit by Species.

Species	Acres	Species	Acres
1. Deer	10,189	6. Dove	7,212
2. Turkey	7,812	7. Woodcock	1,129
3. Bear	4,378	8. Rail	
4. Squirrel	7,812	9. Wood Duck	1,129
5. Quail	7,212		



FOREST-WIDE WILDLIFE HABITAT INVENTORY DATA SHEET

Wildlife Unit Number 6

1. Base Forest Onslow Beach	2. State North Carolina	3. County Onslow	4. Date of Invntry 3 June 1974	5. Invntry Team Wildlife Management Personnel
--------------------------------	----------------------------	---------------------	-----------------------------------	--

6. Aerial Photo Nos.  
90, 108, 125, 156-157, 181-182, 263, 307-308, 363

7. Annual Work Projects: Continuing - C, Planned - P, Estimated Costs

8. <u>Land Use</u>	<u>Acres</u>	9. Present Wildlife Populations - Trends (Pop.: High-H, Medium-M, Low-L Trend: Increase-I, Stationary-S, Decreasing-D)			
A. Military	<u>4,985</u>				
B. Hunting	<u>1,985</u>				
C. Fishing	_____				
D. Forest Mgmt.	_____				
E.	_____				
F.	_____				
G.	_____				
Total Acres	<u>4,985</u>				
		<u>Pop.</u>	<u>Trend</u>	<u>Pop.</u>	<u>Trend</u>
		A. Deer	M	S	
		B. Turkey	_____	_____	
		C. Bear	_____	_____	
		D. Squirrel	_____	_____	
		E. Quail	M	S	
		F. Dove	M	S	
		G. Woodcock	_____	_____	
		H. Rail	H	S	
		I. Rabbit	H	S	
		J. Wood duck	L	S	
		K. Waterfowl	M	S	
		L. Pheasant	L	Unknown	
		M. Otter	M	S	

10. Summarize Timber Conditions. Consider forest types, stand age, classes, including inter-spersion, mast conditions, sites, past timber mgmt, trend based on timber. Summarize other habitat types. Consider quality, use, crop rotation, etc.

<u>Forest Types</u>	<u>Acreege</u>	<u>No./Stands</u>	<u>Other Habitat Types</u>	<u>Acreege</u>
A. Longleaf Pine	_____	_____	H. Wildlife Food Plots	0
B. Loblolly Pine	_____	_____	I. Small Game Strips	0
C. Loblolly Pine-Hardwood	_____	_____	J. Wildlife Openings	0
D. Pond Pine	_____	_____	K. Tactical Landing Zones	0
E. Oak-Hickory	_____	_____	L. Explosive Ord. Impact Area	<u>2,265</u>
F. Cypress-Tupelo	_____	_____	M. Marsh	_____
G. Bottomland Hardwoods	_____	_____	N. Tidelands	<u>2,469</u>
			O. Housing-Industrial	<u>61</u>

11. Summarize Understory Vegetative Conditions. List major vegetative species, browse availability, abundance of fruit and mast producers, browse utilized, cover and other data for wild-life species.

<u>Fruit/Mast Trees</u>	<u>Shrubs/Vines</u>	<u>Herbaceous Plants</u>	<u>Evergreen Cover</u>	<u>Available Browse</u>
Poor _____	Poor _____	Scarce _____	Poor _____	Poor _____
Fair <u>X</u>	Fair _____	Moderate <u>X</u>	Fair _____	Fair _____
Good _____	Good <u>X</u>	Abundant _____	Good <u>X</u>	Good <u>X</u>

Browse Utilization

Light \_\_\_\_\_

Moderate X

Heavy \_\_\_\_\_

COMMENTS:

The coastal beach habitat within this unit is relatively undisturbed except for the small acreage of the Housing-Industrial types.

12. Featured Wildlife Species of Wildlife Unit by priority. Select by (1) - Habitat and User Demand. No particular species will be featured within this unit; however, all species will be considered. Wild trapped ring-necked pheasant were introduced to the unit during FY 74. Numerous sighting of adult birds have been recorded since the release, but no reproduction as yet. American alligators inhabits this unit.

13. Present Improvements:

	<u>No.</u>	<u>Acreage/ Mileage</u>
A. Openings		
1. Sod		
2. Planted		
3. Access Roads	4	9.3 mi
4. Seed-tree Cuts		
5. Clear Cuts		
6. Old Homesites		
B. Shrub Plantings		
C. Power Lines		
D. Firing Ranges		

14. Ponds, Impoundments, Wetlands  
(Existing - E) (Proposed - P)

<u>Name</u>	<u>Acreage</u>	<u>Fish</u>	<u>Waterfowl</u>
_____	_____	_____	_____
_____	_____	_____	_____
_____	_____	_____	_____
_____	_____	_____	_____
_____	_____	_____	_____
_____	_____	_____	_____
_____	_____	_____	_____
_____	_____	_____	_____

15. Streams. (Length - L) (Average Width - W)

<u>Name</u>	<u>L</u>	<u>W</u>	<u>Fresh</u>	<u>Salt</u>	<u>Species</u>
_____	_____	_____	_____	_____	_____
_____	_____	_____	_____	_____	_____
_____	_____	_____	_____	_____	_____
_____	_____	_____	_____	_____	_____
_____	_____	_____	_____	_____	_____

16. Limiting Factors: Deer Turkey Squirrel Bear Quail Dove Rabbit Wood Duck

1. Openings	_____	_____	_____	_____	_____	_____	_____	_____
2. Food	_____	_____	_____	_____	_____	_____	_____	_____
3. Cover	_____	_____	_____	_____	_____	_____	_____	_____
4. Dogs	_____	_____	_____	_____	_____	_____	_____	_____
5. Poaching	_____	_____	_____	_____	_____	_____	_____	_____
6. Under Harvest	_____	_____	_____	_____	_____	_____	_____	_____

17. Recommendations to improve limiting factors. Work plans, est. costs, mileage, acreage, etc., needed. Emphasize key areas. The coastal beach in this unit should receive maximum protection. Increased emphasis on protecting this area will be accomplished through proper coordination.

18. Summarize Acres of Habit by Species.

<u>Species</u>	<u>Acres</u>	<u>Species</u>	<u>Acres</u>
1. Deer	2,400	6. Dove	_____
2. Turkey	_____	7. Woodcock	_____
3. Bear	_____	8. Rail	1,249
4. Squirrel	_____	9. Wood Duck	1,188
5. Quail	1,188		

FOREST-WIDE WILDLIFE HABITAT INVENTORY DATA SHEET

Wildlife Unit Number 7

1. Base Forest Mile Hammock	2. State North Carolina	3. County Onslow	4. Date of Invntry 3 May 1974	5. Invntry Team Wildlife Management Personnel
--------------------------------	----------------------------	---------------------	----------------------------------	--

6. Aerial Photo Nos.  
88-89, 154-156, 178-179, 205-206, 227, 250-251, 361-362

7. Annual Work Projects: Continuing - C, Planned - P, Estimated Costs C-Plant six wildlife food plots to winter grains. Est. Cost \$600.00 P-Plant two miles of forest access roads to perennial grasses. Est. Cost \$420.00

8. Land Use	Acres
A. Military	6,838
B. Hunting	6,269
C. Fishing	7
D. Forest Mgmt.	4,598
E.	_____
F.	_____
G.	_____
Total Acres	6,838

9. Present Wildlife Populations - Trends (Pop.: High-H, Medium-M, Low-L Trend: Increase-I, Stationary-S, Decreasing-D)

	Pop.	Trend		Pop.	Trend
A. Deer	M	I	G. Woodcock	L	S
B. Turkey	H	S	H. Rail	H	S
C. Bear	M	I	I. Rabbit	M	S
D. Squirrel	M	S	J. Wood duck	L	I
E. Quail	M	S	K. Raccoon	H	I
F. Dove	M	S	L. Otter	M	S

10. Summarize Timber Conditions. Consider forest types, stand age, classes, including inter-spersion, mast conditions, sites, past timber mgmt, trend based on timber. Summarize other habitat types. Consider quality, use, crop rotation, etc.

Forest Types	Acreeage	No./Stands	Other Habitat Types	Acreeage
A. Longleaf Pine	345	3	H. Wildlife Food Plots	34.2
B. Loblolly Pine	3,082	25	I. Small Game Strips	9.3
C. Loblolly Pine-Hardwood	451	8	J. Wildlife Openings	14.0
D. Pond Pine	_____	_____	K. Tactical Landing Zones	79.4
E. Oak-Hickory	277	6	L. Explosive Ord. Impact Area	15
F. Cypress-Tupelo	_____	_____	M. Marsh	242
G. Bottomland Hardwoods	493	9	N. Tidelands	595
			O. Housing-Industrial	269

11. Summarize Understory Vegetative Conditions. List major vegetative species, browse availability, abundance of fruit and mast producers, browse utilized, cover and other data for wild-life species.

Fruit/Mast Trees	Shrubs/Vines	Herbaceous Plants	Evergreen Cover	Available Browse
Poor _____	Poor _____	Scarce _____	Poor _____	Poor _____
Fair <u>X</u>	Fair _____	Moderate _____	Fair _____	Fair _____
Good _____	Good <u>X</u>	Abundant <u>X</u>	Good <u>X</u>	Good <u>X</u>

Browse Utilization

Light \_\_\_\_\_

Moderate X

Heavy \_\_\_\_\_

COMMENTS:

The understory of this unit provides an abundance of graze and browse plants.

12. Featured Wildlife Species of Wildlife Unit by priority. Select by (1) - Habitat and User Demand.

Wild turkey will be featured in this unit. American alligator and red-cockaded woodpecker are endangered species inhabiting this unit.

13. Present Improvements:

A.	Openings	No.	Acreage/ Mileage
1.	Sod	6	12 a
2.	Planted	42	17.4 mi
3.	Access Roads		
4.	Seed-tree Cuts		
5.	Clear Cuts		
6.	Old Homesites		
B.	Shrub Plantings		
C.	Power Lines		.85 mi
D.	Firing Ranges		

14. Ponds, Impoundments, Wetlands  
(Existing - E) (Proposed - P)

Name	Acreage	Fish	Waterfowl
Mile Hammock	1.5	Lm-Pf	Lesser Scaup
Ward	1.5	Lm-Pf	Wood Duck
Cedar Point	2.0	Lm-Pf	Lesser Scaup
Powerline	2.0	Lm-Pf	Wood Duck
Courthouse	1.0	Lm-Pf	Wood Duck
Salliers Bay	8.0	Lm-Pf	Wood Duck

15. Streams. (Length - L) (Average Width - W)

Name	L	W	Fresh	Salt	Species
Gillets	2.6	20 ft.		X	Sf-Ng
Traps	1.5	40 ft.		X	Sf-Ng
Holover	1.7	30 ft.		X	Sf-Ng

16. Limiting Factors: Deer Turkey Squirrel Bear Quail Dove Rabbit Wood Duck

1. Openings								
2. Food								
3. Cover								
4. Dogs								
5. Poaching								
6. Under Harvest								

17. Recommendations to improve limiting factors. Work plans, est. costs, mileage, acreage, etc., needed. Emphasize key areas. Fish management consisting of liming, fertilization and maintenance will be done to improve fish production in the five ponds in the unit. Estimated cost is \$378. Establish an additional wildlife food plot. Estimated Cost \$185.

18. Summarize Acres of Habit by Species.

Species	Acres	Species	Acres
1. Deer	6,269	6. Dove	4,105
2. Turkey	4,105	7. Woodcock	4,253
3. Bear	1,171	8. Rail	267
4. Squirrel	4,105	9. Wood Duck	1,171
5. Quail	4,105		

FOREST-WIDE WILDLIFE HABITAT INVENTORY DATA SHEET

Wildlife Unit Number 8

1. Base Forest Bear Garden	2. State North Carolina	3. County Onslow	4. Date of Invntry 3 June 1974	5. Invntry Team Wildlife Management Personnel
-------------------------------	----------------------------	---------------------	-----------------------------------	--

6. Aerial Photo Nos. 83-87, 150-153, 176-177, 359-360	7. Annual Work Projects: Continuing - C, Planned - P, Estimated Costs C-Plant four wildlife food plots to winter grains. Est. Cost \$400. P-Establish two miles of forest access roads to perennial grasses. Est. Cost \$220.
--	---

8. <u>Land Use</u>	<u>Acres</u>	9. Present Wildlife Populations - Trends (Pop.: High-H, Medium-M, Low-L Trend: Increase-I, Stationary-S, Decreasing-D)			
A. Military	<u>4,173</u>				
B. Hunting	_____				
C. Fishing	<u>2.5</u>				
D. Forest Mgmt.	<u>3,360</u>				
E.	_____				
F.	_____				
G.	_____				
Total Acres	<u>4,173</u>				

	Pop.	Trend		Pop.	Trend
A. Deer	M	S	G. Woodcock	L	S
B. Turkey	M	S	H. Rail	_____	_____
C. Bear	H	I	I. Rabbit	L	S
D. Squirrel	M	S	J. Wood duck	M	I
E. Quail	L	S	K.	_____	_____
F. Dove	L	S	L.	_____	_____

10. Summarize Timber Conditions. Consider forest types, stand age, classes, including interpersions, mast conditions, sites, past timber mgmt, trend based on timber. Summarize other habitat types. Consider quality, use, crop rotation, etc.

Forest Types	Acreeage	No./Stands	Other Habitat Types	Acreeage
A. Longleaf Pine	<u>1,159</u>	<u>18</u>	H. Wildlife Food Plots	<u>32.6</u>
B. Loblolly Pine	<u>1,076</u>	<u>15</u>	I. Small Game Strips	<u>3.1</u>
C. Loblolly Pine-Hardwood	<u>120</u>	<u>2</u>	J. Wildlife Openings	<u>6.2</u>
D. Pond Pine	<u>667</u>	<u>4</u>	K. Tactical Landing Zones	<u>23.3</u>
E. Oak-Hickory	_____	_____	L. Explosive Ord. Impact Area	_____
F. Cypress-Tupelo	_____	_____	M. Marsh	_____
G. Bottomland Hardwoods	<u>338</u>	<u>3</u>	N. Tidelands	_____
			O. Housing-Industrial	_____

11. Summarize Understory Vegetative Conditions. List major vegetative species, browse availability, abundance of fruit and mast producers, browse utilized, cover and other data for wildlife species.

Fruit/Mast Trees	Shrubs/Vines	Herbaceous Plants	Evergreen Cover	Available Browse
Poor <u>X</u>	Poor _____	Scarce _____	Poor _____	Poor _____
Fair _____	Fair _____	Moderate _____	Fair _____	Fair _____
Good _____	Good <u>X</u>	Abundant <u>X</u>	Good <u>X</u>	Good <u>X</u>

Browse Utilization  
 Light \_\_\_\_\_  
 Moderate X  
 Heavy \_\_\_\_\_

COMMENTS:

12. Featured Wildlife Species of Wildlife Unit by priority. Select by (1) - Habitat and User Demand.

Black bear will be featured within this unit. The endangered red-cockaded woodpecker inhabits this unit.

13. Present Improvements:

	No.	Acreage/ Mileage
A. Openings		
1. Sod		
2. Planted	4	8
3. Access Roads		
4. Seed-tree Cuts		
5. Clear Cuts		
6. Old Homesites		
B. Shrub Plantings		
C. Power Lines		
D. Firing Ranges		

14. Ponds, Impoundments, Wetlands  
(Existing - E) (Proposed - P)

Name	Acreage	Fish	Waterfowl
Prince	1.0	Im-Cc	Wood Duck
Hog Pen	1.0	Im-Cc	Wood Duck
Oak	.5	Im-Cc	- - -

15. Streams. (Length - L) (Average Width - W)

Name	L	W	Fresh	Salt	Species

16. Limiting Factors: Deer Turkey Squirrel Bear Quail Dove Rabbit Wood Duck

1. Openings	X	X			X		X	
2. Food								
3. Cover								
4. Dogs								
5. Poaching								
6. Under Harvest								

17. Recommendations to improve limiting factors. Work plans, est. costs, mileage, acreage, etc., needed. Emphasize key areas. Clear and establish two additional food plots to winter grains. Estimated Cost \$390. Conduct fish management of three fresh water ponds in the unit. Estimated Cost \$105.

18. Summarize Acres of Habit by Species.

Species	Acres	Species	Acres
1. Deer	4,173	6. Dove	2,355
2. Turkey	2,355	7. Woodcock	458
3. Bear	3,813	8. Rail	
4. Squirrel		9. Wood Duck	458
5. Quail	2,355		

FOREST-WIDE WILDLIFE HABITAT INVENTORY DATA SHEET

Wildlife Unit Number 9

1. Base Forest Goose Creek	2. State North Carolina	3. County Onslow	4. Date of Invntry 4 June 1974	5. Invntry Team Wildlife Management Personnel
-------------------------------	----------------------------	---------------------	-----------------------------------	--

6. Aerial Photo Nos.  
80-87, 148-153, 174-177, 201-204, 226-227, 250-251

7. Annual Work Projects: Continuing - C, Planned - P, Estimated Costs  
C-Plant five wildlife food plots to winter grains. Est. Cost \$500. P-Plant two miles of forest access roads to perennial grasses. Est. Cost \$220.

8. <u>Land Use</u>	<u>Acres</u>	9. Present Wildlife Populations - Trends (Pop.: High-H, Medium-M, Low-L Trend: Increase-I, Stationary-S, Decreasing-D)			
A. Military	<u>4,470</u>				
B. Hunting	<u>3,775</u>				
C. Fishing	<u>      </u>				
D. Forest Mgmt.	<u>4,074</u>				
E.	<u>      </u>				
F.	<u>      </u>				
G.	<u>      </u>				
Total Acres	<u>4,470</u>				

	Pop.	Trend		Pop.	Trend
A. Deer	M	S	G. Woodcock	H	S
B. Turkey	H	S	H. Rail		
C. Bear	M	I	I. Rabbit	M	S
D. Squirrel	M	S	J. Wood duck	M	I
E. Quail	M	S	K. Raccoon	H	I
F. Dove	M	S	L. Otter	M	S

10. Summarize Timber Conditions. Consider forest types, stand age, classes, including interpersions, mast conditions, sites, past timber mgmt, trend based on timber. Summarize other habitat types. Consider quality, use, crop rotation, etc.

<u>Forest Types</u>	<u>Acreage</u>	<u>No./Stands</u>	<u>Other Habitat Types</u>	<u>Acreage</u>
A. Longleaf Pine	<u>266</u>	<u>4</u>	H. Wildlife Food Plots	<u>26.5</u>
B. Loblolly Pine	<u>2,716</u>	<u>21</u>	I. Small Game Strips	<u>4.7</u>
C. Loblolly Pine-Hardwood	<u>599</u>	<u>5</u>	J. Wildlife Openings	<u>1.5</u>
D. Pond Pine	<u>144</u>	<u>1</u>	K. Tactical Landing Zones	<u>6.2</u>
E. Oak-Hickory	<u>56</u>	<u>1</u>	L. Explosive Ord. Impact Area	<u>      </u>
F. Cypress-Tupelo	<u>      </u>	<u>      </u>	M. Marsh	<u>74</u>
G. Bottomland Hardwoods	<u>293</u>	<u>5</u>	N. Tidelands	<u>318</u>
			O. Housing-Industrial	<u>      </u>

11. Summarize Understory Vegetative Conditions. List major vegetative species, browse availability, abundance of fruit and mast producers, browse utilized, cover and other data for wildlife species.

<u>Fruit/Mast Trees</u>	<u>Shrubs/Vines</u>	<u>Herbaceous Plants</u>	<u>Evergreen Cover</u>	<u>Available Browse</u>
Poor <u>      </u>	Poor <u>      </u>	Scarce <u>      </u>	Poor <u>      </u>	Poor <u>      </u>
Fair <u>      </u>	Fair <u>      </u>	Moderate <u>      </u>	Fair <u>      </u>	Fair <u>      </u>
Good <u>  X  </u>	Good <u>  X  </u>	Abundant <u>  X  </u>	Good <u>  X  </u>	Good <u>  X  </u>

Browse Utilization

Light       

Moderate   X  

Heavy       

COMMENTS:

12. Featured Wildlife Species of Wildlife Unit by priority. Select by (1) - Habitat and User Demand. Wild turkey will be featured within this unit. The thirteen active osprey nesting trees and surrounding habitat will receive maximum consideration. Endangered American alligators and red-cockaded woodpeckers inhabit this unit.

13. Present Improvements:

A. Openings	No.	Acreage/ Mileage
1. Sod		
2. Planted	4	12
3. Access Roads	21	16.3 mi
4. Seed-tree Cuts		
5. Clear Cuts	3	218 a
6. Old Homesites	15	7 a
B. Shrub Plantings	1	1.0 a
C. Power Lines		
D. Firing Ranges		

14. Ponds, Impoundments, Wetlands  
(Existing - E) (Proposed - P)

Name	Acreage	Fish	Waterfowl
_____	_____	_____	_____
_____	_____	_____	_____
_____	_____	_____	_____
_____	_____	_____	_____
_____	_____	_____	_____
_____	_____	_____	_____
_____	_____	_____	_____
_____	_____	_____	_____
_____	_____	_____	_____
_____	_____	_____	_____

15. Streams. (Length - L) (Average Width - W)

Name	L	W	Fresh	Salt	Species
Duck Creek	2 $\frac{1}{2}$	10	X	X	Cp-Ng
Goose Creek	1	6	X	X	Cp-Ng
_____	_____	_____	_____	_____	_____
_____	_____	_____	_____	_____	_____
_____	_____	_____	_____	_____	_____

16. Limiting Factors: Deer Turkey Squirrel Bear Quail Dove Rabbit Wood Duck

1. Openings		X			X	X	X	
2. Food								
3. Cover								
4. Dogs								
5. Poaching								
6. Under Harvest								

17. Recommendations to improve limiting factors. Work plans, est. costs, mileage, acreage, etc., needed. Emphasize key areas.

Establish three new openings to perennial grasses. Estimated Cost \$150.

18. Summarize Acres of Habit by Species.

Species	Acres	Species	Acres
1. Deer	4,370	6. Dove	3,271
2. Turkey	3,271	7. Woodcock	3,664
3. Bear	1,092	8. Rail	
4. Squirrel	3,271	9. Wood Duck	948
5. Quail	3,271		



FOREST-WIDE WILDLIFE HABITAT INVENTORY DATA SHEET

Wildlife Unit Number 10

1. Base Forest Stones Creek	2. State North Carolina	3. County Onslow	4. Date of Invntry 5 June 1974	5. Invntry Team Wildlife Management Personnel
--------------------------------	----------------------------	---------------------	-----------------------------------	--

6. Aerial Photo Nos. 15-16, 20-21, 39-47, 64-68	7. Annual Work Projects: Continuing - C, Planned - P, Estimated Costs C-Plant six wildlife plots to winter grains. Est. Cost \$600. P-Establish two miles of forest access roads to perennial grasses. Est. Cost \$220.
--	---

8. <u>Land Use</u>	<u>Acres</u>	9. Present Wildlife Populations - Trends ( <u>Pop.</u> : High-H, Medium-M, Low-L Trend: Increase-I, Stationary-S, Decreasing-D)
A. Military	<u>9,161</u>	
B. Hunting	<u>      </u>	
C. Fishing	<u>      </u>	
D. Forest Mgmt.	<u>7,878</u>	
E.	<u>      </u>	
F.	<u>      </u>	
G.	<u>      </u>	
Total Acres	<u>9,161</u>	

	<u>Pop.</u>	<u>Trend</u>		<u>Pop.</u>	<u>Trend</u>
A. Deer	<u>M</u>	<u>S</u>	G. Woodcock	<u>H</u>	<u>S</u>
B. Turkey	<u>M</u>	<u>I</u>	H. Rail	<u>      </u>	<u>      </u>
C. Bear	<u>M</u>	<u>I</u>	I. Rabbit	<u>M</u>	<u>S</u>
D. Squirrel	<u>M</u>	<u>S</u>	J. Wood duck	<u>M</u>	<u>S</u>
E. Quail	<u>M</u>	<u>S</u>	K. Otter	<u>M</u>	<u>S</u>
F. Dove	<u>M</u>	<u>S</u>	L.	<u>      </u>	<u>      </u>

10. Summarize Timber Conditions. Consider forest types, stand age, classes, including interspersion, mast conditions, sites, past timber mgmt, trend based on timber. Summarize other habitat types. Consider quality, use, crop rotation, etc.

<u>Forest Types</u>	<u>Acreage</u>	<u>No./Stands</u>	<u>Other Habitat Types</u>	<u>Acreage</u>
A. Longleaf Pine	<u>1,036</u>	<u>9</u>	H. Wildlife Food Plots	<u>25.0</u>
B. Loblolly Pine	<u>3,076</u>	<u>35</u>	I. Small Game Strips	<u>3.1</u>
C. Loblolly Pine-Hardwood	<u>1,528</u>	<u>19</u>	J. Wildlife Openings	<u>0</u>
D. Pond Pine	<u>433</u>	<u>9</u>	K. Tactical Landing Zones	<u>0</u>
E. Oak-Hickory	<u>1,576</u>	<u>20</u>	L. Explosive Ord. Impact Area	<u>      </u>
F. Cypress-Tupelo	<u>      </u>	<u>      </u>	M. Marsh	<u>50</u>
G. Bottomland Hardwoods	<u>229</u>	<u>5</u>	N. Tidelands	<u>225</u>
			O. Housing-Industrial	<u>1,936</u>

11. Summarize Understory Vegetative Conditions. List major vegetative species, browse availability, abundance of fruit and mast producers, browse utilized, cover and other data for wildlife species.

<u>Fruit/Mast Trees</u>	<u>Shrubs/Vines</u>	<u>Herbaceous Plants</u>	<u>Evergreen Cover</u>	<u>Available Browse</u>
Poor <u>      </u>	Poor <u>      </u>	Scarce <u>      </u>	Poor <u>      </u>	Poor <u>      </u>
Fair <u>  X  </u>	Fair <u>      </u>	Moderate <u>      </u>	Fair <u>      </u>	Fair <u>      </u>
Good <u>      </u>	Good <u>  X  </u>	Abundant <u>  X  </u>	Good <u>  X  </u>	Good <u>  X  </u>

Browse Utilization  
 Light         
 Moderate   X    
 Heavy       

COMMENTS:

12. Featured Wildlife Species of Wildlife Unit by priority. Select by (1) - Habitat and User Demand. Wild turkey will be featured in this unit. The three active osprey nesting sites and surrounding habitat will receive maximum consideration. The endangered American alligator and red-cockaded woodpecker inhabit this unit.

13. Present Improvements:

	No.	Acreage/ Mileage
A. Openings		
1. Sod	2	2.0 a
2. Planted	5	15.0 a
3. Access Roads	16	14.3 mi
4. Seed-tree Cuts	3	125. a
5. Clear Cuts		
6. Old Homesites	12	6.0 a
B. Shrub Plantings	1	25 a
C. Power Lines	1	4.0 mi
D. Firing Ranges	2	131.0 a

14. Ponds, Impoundments, Wetlands  
(Existing - E) (Proposed - P)

Name	Acreage	Fish	Waterfowl
_____	_____	_____	_____
_____	_____	_____	_____
_____	_____	_____	_____
_____	_____	_____	_____
_____	_____	_____	_____
_____	_____	_____	_____
_____	_____	_____	_____
_____	_____	_____	_____
_____	_____	_____	_____
_____	_____	_____	_____

15. Streams. (Length - L) (Average Width - W)

Name	L	W	Fresh	Salt	Species
Stone Creek	5.3	65 ft.	X	X	Cp-Sf
Everett Creek	2.3	55 ft.		X	Sf-Ng
_____	_____	_____	_____	_____	_____
_____	_____	_____	_____	_____	_____
_____	_____	_____	_____	_____	_____

16. Limiting Factors: Deer Turkey Squirrel Bear Quail Dove Rabbit Wood Duck

1. Openings	_____	_____	_____	_____	_____	_____	_____
2. Food	_____	_____	_____	_____	_____	_____	_____
3. Cover	_____	_____	_____	_____	_____	_____	_____
4. Dogs	_____	_____	_____	_____	_____	_____	_____
5. Poaching	_____	_____	_____	_____	_____	_____	_____
6. Under Harvest	_____	_____	_____	_____	_____	_____	_____

17. Recommendations to improve limiting factors. Work plans, est. costs, mileage, acreage, etc., needed. Emphasize key areas.

18. Summarize Acres of Habit by Species.

Species	Acres	Species	Acres
1. Deer	7,878	6. Dove	6,180
2. Turkey	6,409	7. Woodcock	6,409
3. Bear	3,766	8. Rail	_____
4. Squirrel	6,409	9. Wood Duck	3,333
5. Quail	7,212		

FOREST-WIDE WILDLIFE HABITAT INVENTORY DATA SHEET

Wildlife Unit Number 11

1. Base Forest Hickory Point	2. State North Carolina	3. County Onslow	4. Date of Invntry 6 June 1974	5. Invntry Team Wildlife Management Personnel
6. Aerial Photo Nos. 222-223, 245-248, 333-325		7. Annual Work Projects: Continuing - C, Planned - P, Estimated Costs		
8. Land Use		9. Present Wildlife Populations - Trends (Pop.: High-H, Medium-M, Low-L Trend: Increase-I, Stationary-S, Decreasing-D)		
	<u>Acres</u>		<u>Pop.</u>	<u>Trend</u>
A. Military	3,921			
B. Hunting	425			
C. Fishing	_____			
D. Forest Mgmt.	659			
E.	_____			
F.	_____			
G.	_____			
Total Acres	3,921			
			<u>Pop.</u>	<u>Trend</u>
		A. Deer	H	I
		B. Turkey	M	S
		C. Bear	M	S
		D. Squirrel	M	S
		E. Quail	H	S
		F. Dove	M	S
		G. Woodcock	H	S
		H. Rail	_____	_____
		I. Rabbit	H	S
		J. Wood duck	M	S
		K.	_____	_____
		L.	_____	_____

10. Summarize Timber Conditions. Consider forest types, stand age, classes, including inter-spersion, mast conditions, sites, past timber mgmt, trend based on timber. Summarize other habitat types. Consider quality, use, crop rotation, etc.

<u>Forest Types</u>	<u>Acreege</u>	<u>No./Stands</u>	<u>Other Habitat Types</u>	<u>Acreege</u>
A. Longleaf Pine	_____	_____	H. Wildlife Food Plots	0
B. Loblolly Pine	144	1	I. Small Game Strips	0
C. Loblolly Pine-Hardwood	399	2	J. Wildlife Openings	0
D. Pond Pine	_____	_____	K. Tactical Landing Zones	0
E. Oak-Hickory	_____	_____	L. Explosive Ord. Impact Area	2,335
F. Cypress-Tupelo	_____	_____	M. Marsh	_____
G. Bottomland Hardwoods	116	1	N. Tidelands	_____
			O. Housing-Industrial	_____

11. Summarize Understory Vegetative Conditions. List major vegetative species, browse availability, abundance of fruit and mast producers, browse utilized, cover and other data for wild-life species.

<u>Fruit/Mast Trees</u>	<u>Shrubs/Vines</u>	<u>Herbaceous Plants</u>	<u>Evergreen Cover</u>	<u>Available Browse</u>
Poor _____	Poor _____	Scarce _____	Poor _____	Poor _____
Fair _____	Fair _____	Moderate _____	Fair _____	Fair _____
Good <u>X</u>	Good <u>X</u>	Abundant <u>X</u>	Good <u>X</u>	Good <u>X</u>

Browse Utilization

Light \_\_\_\_\_  
 Moderate \_\_\_\_\_  
 Heavy X

COMMENTS:

Understory vegetation condition for small game is very abundant due to frequent burning.

12. Featured Wildlife Species of Wildlife Unit by priority. Select by (1) - Habitat and User Demand. Deer will be featured within this unit. One osprey nesting site and adjacent habitat will be retained as naturally as possible. The American alligator inhabit this unit.

13. Present Improvements:

A. Openings	No.	Acreage/ Mileage
1. Sod	_____	_____
2. Planted	_____	_____
3. Access Roads	_____	_____
4. Seed-tree Cuts	_____	_____
5. Clear Cuts	_____	_____
6. Old Homesites	_____	_____
B. Shrub Plantings	_____	_____
C. Power Lines	_____	_____
D. Firing Ranges	18	206

14. Ponds, Impoundments, Wetlands  
(Existing - E) (Proposed - P)

Name	Acreage	Fish	Waterfowl
_____	_____	_____	_____
_____	_____	_____	_____
_____	_____	_____	_____
_____	_____	_____	_____
_____	_____	_____	_____
_____	_____	_____	_____

15. Streams. (Length - L) (Average Width - W)

Name	L	W	Fresh	Salt	Species
Mill Creek	2.5 mi	65 ft.	_____	X	Sf
_____	_____	_____	_____	_____	_____
_____	_____	_____	_____	_____	_____
_____	_____	_____	_____	_____	_____
_____	_____	_____	_____	_____	_____

16. Limiting Factors: Deer Turkey Squirrel Bear Quail Dove Rabbit Wood Duck

1. Openings	_____	_____	_____	_____	_____	_____	_____	_____
2. Food	_____	_____	_____	_____	_____	_____	_____	_____
3. Cover	_____	_____	_____	_____	_____	_____	_____	_____
4. Dogs	_____	_____	_____	_____	_____	_____	_____	_____
5. Poaching	_____	_____	_____	_____	_____	_____	_____	_____
6. Under Harvest	X	_____	_____	_____	_____	_____	_____	_____

17. Recommendations to improve limiting factors. Work plans, est. costs, mileage, acreage, etc., needed. Emphasize key areas. Density of deer in this area is quite high. Much of the acreage is used as impact area and hunting limited to the outer edges. Dogs must be used to drive the deer out past hunters.

18. Summarize Acres of Habit by Species.

Species	Acres	Species	Acres
1. Deer	3,921	6. Dove	2,800
2. Turkey	800	7. Woodcock	1,400
3. Bear	818	8. Rail	_____
4. Squirrel	800	9. Wood Duck	818
5. Quail	2,800		

FOREST-WIDE WILDLIFE HABITAT INVENTORY DATA SHEET

Wildlife Unit Number 12

1. Base Forest Town Point	2. State North Carolina	3. County Onslow	4. Date of Invntry 10 June 1974	5. Invntry Team Wildlife Management Personnel
------------------------------	----------------------------	---------------------	------------------------------------	--

6. Aerial Photo Nos. 12-13, 222, 242-244, 328-332	7. Annual Work Projects: Continuing - C, Planned - P, Estimated Costs C-Plant four wildlife food plots to winter grains. Est. Cost \$400. P-Establish two miles of forest access roads to perennial grasses. Est. Cost \$220.
---	--

8. Land Use	Acres	9. Present Wildlife Populations - Trends (Pop.: High-H, Medium-M, Low-L Trend: Increase-I, Stationary-S, Decreasing-D)			
A. Military	<u>3,687</u>				
B. Hunting	<u>3,687</u>				
C. Fishing					
D. Forest Mgmt.	<u>3,551</u>				
E.					
F.					
G.					
Total Acres	<u>3,687</u>				

	Pop.	Trend		Pop.	Trend
A. Deer	H	I	G. Woodcock	H	S
B. Turkey	M	S	H. Rail		
C. Bear	M	I	I. Rabbit	L	S
D. Squirrel	M	S	J. Wood duck	H	I
E. Quail	M	S	K. Raccoon	H	I
F. Dove	M	S	L. Otter	M	S

10. Summarize Timber Conditions. Consider forest types, stand age, classes, including interpersions, mast conditions, sites, past timber mgmt, trend based on timber. Summarize other habitat types. Consider quality, use, crop rotation, etc.

Forest Types	Acreage	No./Stands	Other Habitat Types	Acreage
A. Longleaf Pine			H. Wildlife Food Plots	<u>32.7</u>
B. Loblolly Pine	<u>2,147</u>	<u>16</u>	I. Small Game Strips	<u>0</u>
C. Loblolly Pine-Hardwood	<u>457</u>	<u>7</u>	J. Wildlife Openings	<u>0</u>
D. Pond Pine	<u>421</u>	<u>7</u>	K. Tactical Landing Zones	<u>0</u>
E. Oak-Hickory	<u>306</u>	<u>3</u>	L. Explosive Ord. Impact Area	
F. Cypress-Tupelo			M. Marsh	
G. Bottomland Hardwoods	<u>220</u>	<u>7</u>	N. Tidelands	
			O. Housing-Industrial	

11. Summarize Understory Vegetative Conditions. List major vegetative species, browse availability, abundance of fruit and mast producers, browse utilized, cover and other data for wildlife species.

Fruit/Mast Trees	Shrubs/Vines	Herbaceous Plants	Evergreen Cover	Available Browse
Poor _____	Poor _____	Scarce _____	Poor _____	Poor _____
Fair _____	Fair _____	Moderate _____	Fair _____	Fair _____
Good <u>X</u>	Good <u>X</u>	Abundant <u>X</u>	Good <u>X</u>	Good <u>X</u>

Browse Utilization  
 Light \_\_\_\_\_  
 Moderate \_\_\_\_\_  
 Heavy X

COMMENTS:

Either sex hunts conducted during FY 74 to improve herd productivity.

12. Featured Wildlife Species of Wildlife Unit by priority. Select by (1) - Habitat and User Demand. Wild turkey will be featured within this area. The osprey nesting habitat along Town Creek will be protected. American alligator and red-cockaded woodpecker inhabit this unit.

13. Present Improvements:

A. Openings	No.	Acreage/ Mileage
1. Sod	2	2.0 mi
2. Planted	5	23 a
3. Access Roads	10	12.6 mi
4. Seed-tree Cuts		
5. Clear Cuts	3	75 a
6. Old Homesites	19	9.5 a
B. Shrub Plantings		
C. Power Lines		
D. Firing Ranges		

14. Ponds, Impoundments, Wetlands  
(Existing - E) (Proposed - P)

Name	Acreage	Fish	Waterfowl
Town Creek	15.0		X
Impoundment			

15. Streams. (Length - L) (Average Width - W)

Name	L	W	Fresh	Salt	Species
Town Creek	2.0 mi	30 ft.		X	Sf-Ng

16. Limiting Factors: Deer Turkey Squirrel Bear Quail Dove Rabbit Wood Duck

1. Openings								
2. Food								
3. Cover								
4. Dogs								
5. Poaching								
6. Under Harvest								

17. Recommendations to improve limiting factors. Work plans, est. costs, mileage, acreage, etc., needed. Emphasize key areas.

18. Summarize Acres of Habit by Species.

Species	Acres	Species	Acres
1. Deer	3,687	6. Dove	2,190
2. Turkey	2,910	7. Woodcock	3,130
3. Bear	1,404	8. Rail	
4. Squirrel	2,190	9. Wood Duck	983
5. Quail	2,190		

FOREST-WIDE WILDLIFE HABITAT INVENTORY DATA SHEET

Wildlife Unit Number 13

1. Base Forest Lewis Creek	2. State North Carolina	3. County Onslow	4. Date of Invntry 11 June 1974	5. Invntry Team Wildlife Management Personnel
-------------------------------	----------------------------	---------------------	------------------------------------	--

6. Aerial Photo Nos. 14, 35-38, 61-63	7. Annual Work Projects: Continuing - C, Planned - P, Estimated Costs C-Plant four wildlife plots to winter grains. Estimated Cost \$400. P-Seed two miles of forest access roads to perennial grasses. Est. Cost \$210.
--	---

8. <u>Land Use</u>	<u>Acres</u>	9. Present Wildlife Populations - Trends (Pop.: High-H, Medium-M, Low-L Trend: Increase-I, Stationary-S, Decreasing-D)			
A. Military	<u>4,457</u>				
B. Hunting	<u>4,457</u>				
C. Fishing					
D. Forest Mgmt.	<u>4,171</u>				
E.					
F.					
G.					
Total Acres	<u>4,457</u>				

	Pop.	Trend		Pop.	Trend
A. Deer	M	I	G. Woodcock	M	S
B. Turkey	M	S	H. Rail		
C. Bear	M	I	I. Rabbit	L	S
D. Squirrel	M	I	J. Wood duck	M	S
E. Quail	M	S	K. Raccoon	H	I
F. Dove	M	S	L. Otter	M	S

10. Summarize Timber Conditions. Consider forest types, stand age, classes, including inter-spersion, mast conditions, sites, past timber mgmt, trend based on timber. Summarize other habitat types. Consider quality, use, crop rotation, etc.

Forest Types	Acreeage	No./Stands	Other Habitat Types	Acreeage
A. Longleaf Pine	<u>926</u>	<u>12</u>	H. Wildlife Food Plots	<u>24.9</u>
B. Loblolly Pine	<u>1,529</u>	<u>14</u>	I. Small Game Strips	<u>0</u>
C. Loblolly Pine-Hardwood	<u>588</u>	<u>6</u>	J. Wildlife Openings	<u>0</u>
D. Pond Pine	<u>966</u>	<u>14</u>	K. Tactical Landing Zones	<u>62.2</u>
E. Oak-Hickory	<u>33</u>	<u>1</u>	L. Explosive Ord. Impact Area	
F. Cypress-Tupelo			M. Marsh	
G. Bottomland Hardwoods	<u>96</u>	<u>4</u>	N. Tidelands	
			O. Housing-Industrial	

11. Summarize Understory Vegetative Conditions. List major vegetative species, browse availability, abundance of fruit and mast producers, browse utilized, cover and other data for wildlife species.

Fruit/Mast Trees	Shrubs/Vines	Herbaceous Plants	Evergreen Cover	Available Browse
Poor _____	Poor _____	Scarce _____	Poor _____	Poor _____
Fair _____	Fair _____	Moderate _____	Fair _____	Fair _____
Good <u>X</u>	Good <u>X</u>	Abundant <u>X</u>	Good <u>X</u>	Good <u>X</u>

Browse Utilization

Light \_\_\_\_\_  
Moderate \_\_\_\_\_  
Heavy X

COMMENTS:

12. Featured Wildlife Species of Wildlife Unit by priority. Select by (1) - Habitat and User Demand. Deer will be featured in this unit. The osprey nesting habitat along Southwest Creek will be protected. American alligator inhabit this unit.

13. Present Improvements:

A. Openings	No.	Acreage/ Mileage
1. Sod	1	1 mi
2. Planted	2	12 a
3. Access Roads	10	13.0 mi
4. Seed-tree Cuts		
5. Clear Cuts		
6. Old Homesites		
B. Shrub Plantings		
C. Power Lines		
D. Firing Ranges		

14. Ponds, Impoundments, Wetlands  
(Existing - E) (Proposed - P)

Name	Acreage	Fish	Waterfowl
_____	_____	_____	_____
_____	_____	_____	_____
_____	_____	_____	_____
_____	_____	_____	_____
_____	_____	_____	_____
_____	_____	_____	_____
_____	_____	_____	_____
_____	_____	_____	_____

15. Streams. (Length - L) (Average Width - W)

Name	L	W	Fresh	Salt	Species
Lewis Creek	2.5	30 ft.		X	Sf-Ng
_____	_____	_____	_____	_____	_____
_____	_____	_____	_____	_____	_____
_____	_____	_____	_____	_____	_____
_____	_____	_____	_____	_____	_____

16. Limiting Factors: Deer Turkey Squirrel Bear Quail Dove Rabbit Wood Duck

1. Openings		X			X	X	X	
2. Food								
3. Cover								
4. Dogs								
5. Poaching								
6. Under Harvest								

17. Recommendations to improve limiting factors. Work plans, est. costs, mileage, acreage, etc., needed. Emphasize key areas.

Establish an additional wildlife food plot in this unit. Estimated Cost \$275.

18. Summarize Acres of Habit by Species.

Species	Acres	Species	Acres
1. Deer	4,458	6. Dove	3,076
2. Turkey	2,246	7. Woodcock	717
3. Bear	1,095	8. Rail	
4. Squirrel	2,246	9. Wood Duck	717
5. Quail	3,076		



FOREST-WIDE WILDLIFE HABITAT INVENTORY DATA SHEET

Wildlife Unit Number 14

1. Base Forest Southwest Creek	2. State North Carolina	3. County Onslow	4. Date of Invntry 13 June 1974	5. Invntry Team Wildlife Management Personnel
-----------------------------------	----------------------------	---------------------	------------------------------------	--

6. Aerial Photo Nos.  
7-10, 27-34, 55-59

7. Annual Work Projects: Continuing - C, Planned - P, Estimated Costs C-Plant three wildlife food plots to winter grains. Est. Cost \$300. P-Plant two miles of forest access roads to perennial grasses.

8. Land Use	Acres	9. Present Wildlife Populations - Trends (Pop.: High-H, Medium-M, Low-L Trend: Increase-I, Stationary-S, Decreasing-D)			
A. Military	<u>9,546</u>				
B. Hunting	<u>4,482</u>				
C. Fishing	_____				
D. Forest Mgmt.	<u>4,574</u>				
E.	_____				
F.	_____				
G.	_____				
Total Acres	<u>9,546</u>				
		Pop.	Trend	Pop.	Trend
		A. Deer	H I	G. Woodcock	H S
		B. Turkey	L I	H. Rail	_____
		C. Bear	L S	I. Rabbit	L S
		D. Squirrel	H S	J. Wood duck	H I
		E. Quail	M S	K. Raccoon	H I
		F. Dove	M S	L. Otter	M S

10. Summarize Timber Conditions. Consider forest types, stand age, classes, including inter-spersion, mast conditions, sites, past timber mgmt, trend based on timber. Summarize other habitat types. Consider quality, use, crop rotation, etc.

Forest Types	Acreage	No./Stands	Other Habitat Types	Acreage
A. Longleaf Pine	_____	_____	H. Wildlife Food Plots	<u>20.2</u>
B. Loblolly Pine	<u>2,500</u>	<u>29</u>	I. Small Game Strips	_____
C. Loblolly Pine-Hardwood	<u>793</u>	<u>8</u>	J. Wildlife Openings	_____
D. Pond Pine	_____	_____	K. Tactical Landing Zones	_____
E. Oak-Hickory	_____	_____	L. Explosive Ord. Impact Area	_____
F. Cypress-Tupelo	_____	_____	M. Marsh	_____
G. Bottomland Hardwoods	<u>1,128</u>	<u>11</u>	N. Tidelands	<u>282</u>
			O. Housing-Industrial	<u>743</u>

11. Summarize Understory Vegetative Conditions. List major vegetative species, browse availability, abundance of fruit and mast producers, browse utilized, cover and other data for wildlife species.

Fruit/Mast Trees	Shrubs/Vines	Herbaceous Plants	Evergreen Cover	Available Browse
Poor _____	Poor _____	Scarce _____	Poor _____	Poor _____
Fair <u>X</u>	Fair _____	Moderate _____	Fair _____	Fair <u>X</u>
Good _____	Good <u>X</u>	Abundant <u>X</u>	Good <u>X</u>	Good _____

Browse Utilization

Light \_\_\_\_\_  
 Moderate X  
 Heavy \_\_\_\_\_

COMMENTS:

One of the best areas for fish wildlife exist along Southwest Creek in this unit. Maximum habitat retention is emphasized here.

12. Featured Wildlife Species of Wildlife Unit by priority. Select by (1) - Habitat and User Demand.

Deer are featured for this unit. The American alligator inhabits this area.

13. Present Improvements:

A. Openings	No.	Acreage/ Mileage
1. Sod		
2. Planted	3	5.0 a
3. Access Roads	16	11.4 mi
4. Seed-tree Cuts	1	40 a
5. Clear Cuts		
6. Old Homesites	12	6.0 a
B. Shrub Plantings		
C. Power Lines		
D. Firing Ranges		

14. Ponds, Impoundments, Wetlands  
(Existing - E) (Proposed - P)

Name	Acreage	Fish	Waterfowl
_____	_____	_____	_____
_____	_____	_____	_____
_____	_____	_____	_____
_____	_____	_____	_____
_____	_____	_____	_____
_____	_____	_____	_____

15. Streams. (Length - L) (Average Width - W)

Name	L	W	Fresh	Salt	Species
Southwest Creek	5.8 mi	58 ft.	X	_____	_____
_____	_____	_____	_____	_____	_____
_____	_____	_____	_____	_____	_____
_____	_____	_____	_____	_____	_____
_____	_____	_____	_____	_____	_____

16. Limiting Factors: Deer Turkey Squirrel Bear Quail Dove Rabbit Wood Duck

1. Openings	_____	X	_____	_____	X	X	X	_____
2. Food	_____	_____	_____	_____	_____	_____	_____	_____
3. Cover	_____	_____	_____	_____	_____	_____	_____	_____
4. Dogs	X	_____	_____	_____	_____	_____	_____	_____
5. Poaching	X	_____	_____	_____	_____	_____	_____	_____
6. Under Harvest	_____	_____	_____	_____	_____	_____	_____	_____

17. Recommendations to improve limiting factors. Work plans, est. costs, mileage, acreage, etc., needed. Emphasize key areas.

Establish additional wildlife food plot in this unit. Estimated Cost \$180. Establish another hunter check station near Verona entrance to the area.

18. Summarize Acres of Habit by Species.

Species	Acres	Species	Acres
1. Deer	4,525	6. Dove	2,542
2. Turkey	2,818	7. Woodcock	3,403
3. Bear	1,557	8. Rail	_____
4. Squirrel	2,542	9. Wood Duck	1,063
5. Quail	2,542		

U.  
COOPERATIVE PLAN  
CONSERVATION OF FISH AND WILDLIFE RESOURCES  
U. S. MARINE CORPS BASE, CAMP LEJEUNE, NORTH CAROLINA

I. Authority

A. In accordance with the authority contained in Public Law 85-337 (approved 28 February 1958) and in Public Law 86-797 (approved 15 September 1960), the Department of Defense, the Department of the Interior, and the state of North Carolina, through their duly designated representatives whose signatures appear below, approved the following cooperative plan for the protection, development and management of fish and wildlife resources on Marine Corps Base, Camp Lejeune.

B. Under the authority delegated to him by higher echelons of command, the Commander, Marine Corps Base, hereinafter referred to as the Commanding General, is recognized as the official representative of the Commandant of the Marine Corps.

C. Under the authority vested in him, the Regional Director, Bureau of Sports Fisheries and Wildlife, hereinafter referred to as the Regional Director, is recognized as the official representative of Sports Fisheries and Wildlife.

D. Under the authority vested in him, by the state of North Carolina, the Executive Director, North Carolina Wildlife Resources Commission, hereinafter referred to as the Executive Director, is recognized as the official representative of the state of North Carolina.

E. By definition, action by and to the Marine Corps shall be understood to refer specifically to the U. S. Marine Corps Base, Camp Lejeune, North Carolina.

II. Forest - Wide Wildlife Habitat Inventory

An inventory of fish and wildlife resources was completed in 1973 and included in the updated Management Plan for the Base. The inventory was accomplished through the cooperation of field personnel of all three representatives to this agreement. The inventory was planned to identify and describe habitat conditions of all present species regardless of the degree of public use.

III. Base - Fish and Wildlife Management Plan

The plan for the management of fish and wildlife was updated in 1973. This plan, primarily, involves management techniques for fresh water game fish, upland game animals, upland game birds, fur-bearing animals, migratory waterfowl and endangered species. Consideration will be given to all other fish and wildlife species present in all aspects of management.

IV. The Cooperative Plan

The Marine Corps Base, the Bureau of Sports Fisheries and Wildlife, and the North Carolina Wildlife Resources Commission agree to assist together in preparing and implementing a progressive program of fish and wildlife conservation for the Base. Meetings may be called as necessary by the three parties to review the fish and wildlife management program.

A. Cooperative Responsibility

1. Marine Corps Base will execute the Fish and Wildlife Management Plan, provide labor, equipment, and materials for habitat improvement and development, work effectively and in harmony with local, state and federal conservation officials, provide within manageable quotas for controlled public access for the purpose of hunting, fishing and trapping, and regulate the taking of fish and wildlife in accordance with applicable local, state and federal laws and regulations. Marine Corps Base will retain and protect all wildlife habitat to the fullest extent possible for all numerous and unique species. The Base will promote an educational program of Wildlife Conservation to increase public awareness of wise use of these natural resources.

2. The Bureau of Sports Fisheries and Wildlife will render technical advice and professional assistance through the Regional Director, Atlanta, Georgia, concerning management of fish and wildlife. The Bureau will assist in censusing of birds and mammals through its field personnel who visits the Base. Fish for restocking ponds and lakes will be provided through the Bureau's Federal Hatchery at Edenton, North Carolina.

3. The North Carolina Wildlife Resources Commission will provide technical assistance and professional advice, through its Executive Director, Raleigh, North Carolina, concerning the management of fish and wildlife. Assistance for censusing fish and wildlife will be provided through biologists who call upon Base Conservation Personnel. The commission will provide seed mixtures and plants as needed and as available for upland game and migratory species. Fresh water fish will be provided by the Wildlife Resources Commission through its state Hatchery at Fayetteville, North Carolina.

#### B. Development and Improvement of Habitat

Present habitat conditions are good to excellent for both game and nongame species. White-tailed Deer, Wild Turkey, Squirrel, Rabbit, Quail and Waterfowl are the featured game. Other game and nongame species will be considered in all phases of management. Additional grassy openings are needed in some wildlife units and will be established in the near future. Forest access roads will be utilized for wildlife enhancement by establishing many of these in perennial grass plantings. Wetlands, bottomlands, hardwoods and hardwood stands on slopes or inclusions will be managed for wildlife. The Forester and Wildlife Manager will coordinate management activities to conform to the "Multiple Use" concept.

#### C. Restoration or Restocking of Desired Species

Restocking practices on the Base will normally be limited to releasing fresh water game fish into ponds, lakes and streams. The introduction of exotic species of fish and wildlife is prohibited. Only wild trapped birds and animals which are native may be released on the Base at such times that might warrant restocking efforts in the future. Preliminary studies will be required by the three parties before any restocking is permitted in the future.

#### D. Control of Plant and Animal Species

1. All game species will be controlled through hunting to keep populations from reaching high densities which could limit essential requirements for food and cover.

2. Raccoon will be controlled through opening a trapping season to reduce the dense population that now exists.

3. Aquatic weeds will be controlled in ponds and lakes through the application of aquatic herbicides by management personnel as necessary.

#### E. Protection of Fish and Wildlife

The taking of fish and wildlife will be within the manner and limits prescribed by local, state and federal laws and regulations. All hunting and fishing access is controlled through a centrally located checking station. Game kills are reported in at the checking station where they are inspected and management data are collected.

#### F. Public Use of Fish and Wildlife Resources

Consumptive use of fish and wildlife resources by the public is through hunting, fishing, and trapping. Non-consumptive use of fish and wildlife includes nature study, viewing and photographing wildlife. Plans are to make non-consumptive use more available to the public. The present civilian guest use of fish and wildlife resources comprises twenty-seven percent of the total number of trips for fishing and hunting. The following persons are authorized to hunt, fish and trap on Base:

1. Military personnel, including retired, and their dependents.

2. Civilians assigned to or employed on the Base or living in Base housing and their dependents to include Civil Service employees retired from Marine Corps Base.

3. All civilians (other than employees) when accompanied by a military or civilian employee sponsor. Sponsors of such persons are responsible for their proper conduct. A sponsor may take with him no more than two guests on an individual hunt without special permission.

4. Public access to hunting, fishing and trapping will be on a first-come, first-served basis within manageable quotas.

G. Permit Requirements and Use of Funds

1. All persons authorized to hunt, fish and trap shall have in their possession a valid North Carolina or Onslow County hunting, fishing and/or trapping license. A big game permit is required to hunt deer and turkey. Persons hunting migratory waterfowl shall have in their possession a valid Federal Migratory Bird Stamp.

2. All persons must, additionally, apply for a Base Permit to meet the requirements for hunting, fishing and trapping on Base.

3. Types of Permits, Fees and Effective Dates

- a. Combination Hunting/Fishing - to military personnel, civilian employees and their dependents:  
1 August - 31 July \$ 2
- b. Fishing Permits - to military personnel, civilian employees, their dependents:  
1 January - 31 December \$ 1
- c. Special Combination Hunting/Fishing - to civilian guests:  
1 August - 31 July \$10
- d. Daily Hunting/Fishing Permits - to civilian guests:  
\$ 2
- e. Trapping Permits - to military personnel, civilian employees, and their dependents:  
1 August - 31 July \$ 3

4. Fees for Base permits will be collected by an appointed collection agent. The collection agent is accountable for all fees and is responsible for depositing fees with the Base Comptroller to a special non-appropriated project fund.

5. This project fund will be expended against an Annual Operational Plan for fish and wildlife management.

H. Technical Advice and Assistance

1. The Regional Director, Bureau of Sports Fisheries and Wildlife through his state Field Supervisor, Raleigh, North Carolina, and his Field Supervisor, Gatlinburg, Tennessee, will provide fish and wildlife management services and assistance to the Base.

2. The Executive Director, North Carolina Wildlife Resources Commission will provide through his Eastern Game Lands Supervisor, New Bern, North Carolina, big game management services; through his Wildlife Biologist, Kinston, North Carolina, small game management services; through his Wildlife Biologist, Milton, North Carolina, wild turkey management services; through his Wildlife Biologist, Washington, North Carolina, waterfowl management services; and through his Wildlife Patrolman, Jacksonville, North Carolina, wildlife law enforcement services.

This Cooperative Plan, upon its adoption as witnessed by its execution will be in full force and effect for an indefinite period. The plan is subject to amendment or revision as may be agreed upon by all parties represented. A request for an amendment or revision of the Cooperative Plan may originate with anyone of the represented parties. This plan supersedes the Cooperative Plan of February 10, 1969.

FOR THE DEPARTMENT OF DEFENSE  
BY /s/ R. D. BOHN  
TITLE Commanding General  
MARINE CORPS BASE, CAMP LEJEUNE  
NORTH CAROLINA 28542  
DATE 11/27/73

FOR THE STATE OF NORTH CAROLINA  
BY /s/ CLYDE P. PATTON  
TITLE Executive Director

WILDLIFE RESOURCES COMMISSION, DEPARTMENT OF NATURAL AND ECONOMIC RESOURCES  
RALEIGH, NORTH CAROLINA 27611 DATE 11/14/73

FOR THE DEPARTMENT OF THE INTERIOR  
BY /s/ C. EDWARD CARLSON  
TITLE Regional Director  
DEPARTMENT OF INTERIOR, FISH AND  
WILDLIFE SERVICE, BUREAU OF SPORTS  
FISHERIES AND WILDLIFE  
17 EXECUTIVE PARK DRIVE, N. E.  
ATLANTA, GEORGIA 30309  
DATE 10/30/73



R  
E  
C  
R  
E  
A  
T  
I  
O  
N

RECREATION

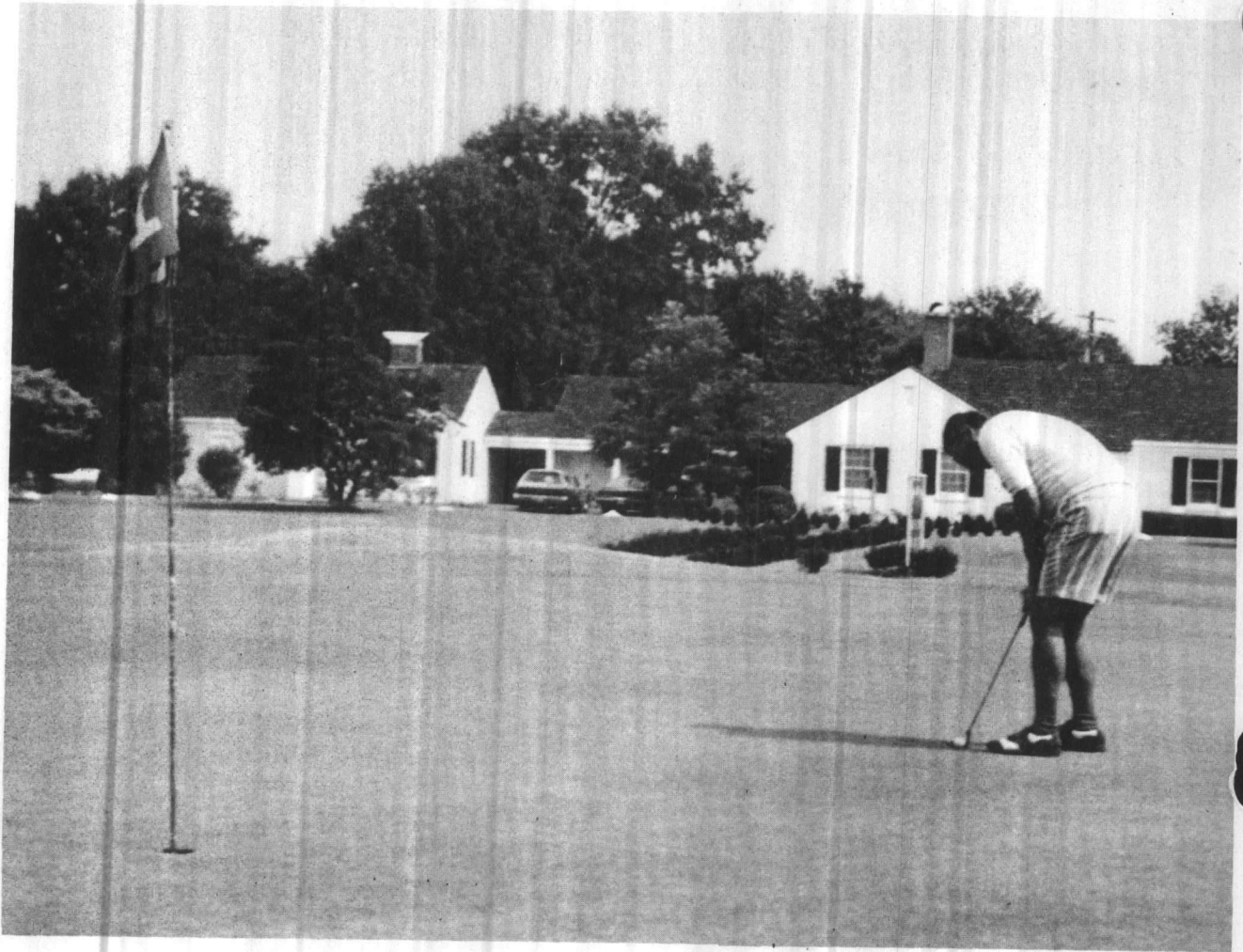

# RECREATION AREAS MAINTENANCE PROGRAM

The maintenance of natural resource oriented recreational areas is the responsibility of Special Services Maintenance, a separate operation from Base Maintenance, although the two work closely together. This plan establishes a management program for the development and maintenance of the recreational areas.

The objective of this program is to provide a quality recreational environment that will be attractive to the users of these areas. The plan sets forth specific treatment needs and maintenance of the natural resource-oriented areas.

## A. ATHLETIC FIELDS

Providing a good ground cover using adapted lawn grasses is the primary objective in planning for maintenance of the athletic fields. The following treatment will be carried out according to the species of grass selected for each specific site.

Bermuda 328 or 419 will be established on Liversedge field, Harry Agganis field, the intramural field and the football field at Tarawa Terrace. Lime will be applied to these fields in accordance with recommendations from soil tests. These tests will be made every three years. Annually, the fields will be aerified in two directions in April and July. Fertilization will be with 400 pounds of 16-4-8 per acre per month during the growing season. Verti-cutting of these fields will be scheduled twice yearly. The first verti-cutting will be done in the spring when the grass becomes green and the second verti-cutting will be done in July. Verti-cutting will be done in two directions at a depth of  $\frac{1}{4}$  inch. Mowing will be scheduled so as not to remove more than  $\frac{1}{2}$  of the total leaf surface per mowing with the mowers set at a height of  $\frac{3}{4}$  of an inch. Herbicides will be applied annually in June and August to control weeds.

Carpetgrass is the predominant grass on the baseball field adjacent to the field house. Management of this area will be in accordance with the management of carpetgrass as described in Improved Grounds Management - A. Lawns of this plan.

Common bermudagrass is established on the baseball fields at Tarawa Terrace, Midway Park and the Stone Street Little League baseball and football fields. Most of these areas have good stands of grass which can be retained with good management. Those areas needing re-establishment will be seeded using two pounds of common bermudagrass per 1,000 square foot. Apply 400 pounds of 16-4-8 fertilizer per acre per month during the growing season. These areas will be limed in accordance with recommendations of a soil test. Aerification will be done twice annually in April and July. Aerifying will be done in two directions at right angles. Mowing height for the common bermudagrass will be one inch with no more than  $\frac{1}{2}$  of the total leaf surface removed per mowing.

There are several areas on the athletic fields needing drainage. The Tarawa Terrace football field will be drained using three lines of drain tile. One line will be installed on each sideline and a third line will be installed through the center of the field. Catch basins will be installed along the sidelines to outlet surface water into the tile lines. This field and the football field on Stone Street will be regraded to an 18-inch crown turtle back from the center to the sidelines. The Stone Street baseball fields will have the infields turtle-backed



by filling and grading to a 1% slope from the edge of the mound to the base path. All re-graded areas will be seeded or sprigged to the planned grasses as soon after grading as possible.

B. SKEET RANGE

This area has a good stand of carpetgrass in most places and will be maintained in accordance with guidelines for carpetgrass lawns. The skeet range will be aerified twice annually in April and July.

C. CAMPSITES

A camping area for base personnel has been set up on Onslow Beach north of the bridge. This area will be seeded to bahiagrass in the spring of 1975. The area will be disked and a good seedbed prepared. Lime and fertilizer will be applied as recommended by a soil test of the area. Seeding will be at a rate of 2 pounds per 1,000 square foot. The area will be irrigated as necessary to assure seed germination and survival of seedlings. Maintenance will be carried out annually in accordance with guidelines for bahiagrass lawns. A shrub border of Japanese privet (3 to 4 ft. spacing), northern bayberry (2 to 3 ft. spacing), oleander (3 to 4 ft. spacing) or shrubby yew podocarpus (3 to 4 ft. spacing) will be planted around the campsite. This will provide campers with some privacy and protection from wind blown sand.

D. ONSLow BEACH

Maintenance of the trailer rental units on the beach is the responsibility of Special Services. Trailer sites will be covered with topsoil to a depth of five inches. A bermudagrass lawn will be established and the sites landscaped with adapted shrubbery. The book Seacoast Plants of the Carolinas will be used as a reference in developing the landscape plans.

E. PICNIC AREA

The picnic area at Gottschalk Marina is eroding in many areas. This area will be covered with topsoil and seeded to Kentucky bluegrass and pennlawn red fescue. The mixture will be 80 percent bluegrass and 20 percent fescue seeded at the rate of 3 pounds per 1,000 square feet. Seeding will be done in early fall and lime and fertilizer will be applied according to recommendations of a soil test. The area will be mulched and foot traffic kept off until after the second mowing. Annually apply <sup>2.5</sup>~~2~~ pounds of 10-10-10 per <sup>1,000</sup> square foot in September and early March. Mowing will be no lower than two inches. Aerification will be done twice annually in March and September.

F. GRAZED AREAS

The base stables have approximately 28 acres of openland on which to produce forage. A ten acre wooded area adjoining the present pastureland is scheduled to be cleared and established in adapted forages in 1975.

Forage plants - coastal bermudagrass, clover and fescue will be established and managed to provide maximum grazing throughout the year. The coastal bermudagrass pastures will be overseeded with small grain to broaden distribution of forage production. Using high management

practices for maintaining plant stands and for maximum yields, the potential forage production of this 38 acres of pastureland is 365 animal unit months of grazing per year or 12 months grazing for 30 horses. Care will be exercised to maintain only the number of horses sufficient to utilize forage produced without overgrazing and subsequently damaging plant stand and reducing yields. The two large pastures immediately behind the stables and riding rings, approximately  $12\frac{1}{2}$  acres, will be sprigged with coastal bermudagrass in the spring of 1974. The remaining pasture fields, approximately 15 acres, will be seeded in ladino clover and fescue in the fall of 1974. The wooded area scheduled to be cleared will be seeded in ladino clover and fescue in the fall of 1975.

1. Coastal bermudagrass establishment and management will be carried out in accordance with the following guidelines. Lime and fertilizer will be applied according to soil test recommendations and disked into the soil. A good seedbed will be prepared and 50 bushels of sprigs will be broadcast per acre. The sprigs will be kept moist before planting and will be planted the same day they are dug. They will be protected with a tarpaulin while they are being hauled to the planting site. The sprigs will be covered with a disk harrow. When the new growth starts, topdressing will be applied at the rate of 50 units of nitrogen per acre. All stock will be kept off the pasture until the plants are six to ten inches high. The pasture will then be grazed back to a height of three inches and the stock removed. Fifty units of nitrogen per acre will be applied following the removal of the stock. Grazing will be resumed when plants are six to ten inches high. Annual fertilization for maintenance will be 1,000 pounds of 8-8-8 or its equivalent in March and fifty units of nitrogen after each grazing (monthly). Lime requirements will be checked every three years and lime applied according to the soil's needs. After a good stand of coastal bermudagrass is established, overseeding with annual rye maybe accomplished with a grain drill. Checks for damage to the coastal bermudagrass stand will be made annually before overseeding. If the competition from the previous years overseeding has weakened the stand of coastal bermudagrass, then overseeding will be deferred until the following year. This will allow the coastal bermudagrass to maintain a healthy, virgorous stand.

2. Ladino clover and fescue pasture will be established and maintained in accordance with the following guidelines. Seeding will be done in September. The seedbed will be prepared using a disk harrow. Lime and fertilizer will be applied in accordance with a soil test recommendation. Seed 15 pounds of fescue and 6 pounds of inoculated ladino clover per acre. The seed will be covered approximately  $\frac{1}{2}$  inch deep. Stock is to be kept off the area until the plants are six to eight inches tall. Move the stock from pasture to pasture so that areas will be grazed no lower than three inches. Annual fertilization for maintenance will be with 800 pounds of 0-14-14 per acre and 200 units of nitrogen in split applications during the growing season. These pastures will be renovated when less than 20% of the stand is clover.

Experiences indicate that pregnant mares may abort when grazing on poorly limed old fescue pastures. This is due to a magnesium deficiency. To reduce this problem a mineral ration containing magnesium will be available for the horses at all times and optimum pH levels will be maintained by applying dolomitic lime. Lime will be applied eight to ten months in advance of putting pregnant mares on old fescue pastures needing lime. The present fencing arrangement is an excellent one for rotating grazing stock. Past pasture plantings have failed due to

overgrazing. This has resulted in higher hay and feed bills and poor utilization of the pasture areas. During and following establishment of this new pasture program, stock will be rotated to assure full benefits from the pasture area.

#### G. GOLF COURSES

The Camp Lejeune complex includes two 18-hole golf courses involving 420 acres of cleared, highly improved land. In addition to the two courses, there are four putting greens and two driving ranges. The Base Maintenance Department has the responsibility for maintaining the courses, utilizing Special Services personnel and funds. The two courses were constructed during the early 1940's using the grasses available at the time. The courses have been gradually renovated over the years as new and better materials became available. The courses are maintained under the guidance of the United States Golf Association, Turf and Grass Section of the Mid-Atlantic Region which inspects the courses and the maintenance operation each year and makes recommendations for improvement.

This plan presents essential management data needed for annual maintenance of the golf course area. New materials and grass varieties maybe injected into the plan as they are tested and cleared for usage on golf course areas.

1. Greens. The grass used for greens is Tifton 328 bermuda. These areas will be fertilized monthly using a 4-1-3 ratio fertilizer during the bermudagrass growing season. A 45-0-0 nitrogen fertilizer will be used during these months as needed to maintain a lush growth. A mixture of Manhattan ryegrass and pennlawn fescue will be used for overseeding the greens in winter. Winter fertilization will be monthly, using 24-0-0 nitrogen fertilizer. This will maintain a good growth of the overseeded grass, but will not produce a vigorous growth that would damage the bermuda.

Grass cutting is an important part of management. Greens will be cut daily at a height of  $\frac{1}{4}$  inch and all clipping will be caught and removed from the area. The greens will be verticut each week and aerified twice each year. Cup and pin locations will be changed three times each week. Watering of the greens will be scheduled as required to provide ample moisture for maintaining a quality turf.

Insect control on the greens will be a regular part of management. Greens will be treated five times per year with Sevin (80%). Control methods for any special insect problems will be discussed with the base pest control section or local extension agent.

Fungus control for the greens will be carried out through a preventative spray program - applying Daconil 2787 once every three weeks. Weeds will be controlled by applying Dol-E-Rad in a spray mixture three times per year.

2. Tees. The tees of the two golf courses are established in Tifton 419 bermudagrass. These areas will be fertilized annually using the same fertilization rates as the greens. The tees will be overseeded with common ryegrass.

Insect weed and disease control for tee areas will be the same as stated previously for green areas.

3. Other Grassed Areas. Fairways, roughs, driving ranges and the clubhouse lawn have stands of carpetgrass or common bermudagrass. These areas will receive a 4-1-3 ratio fertilizer three times per year. The first application will be in April, the second application will be in July and the third application will be in September. Fairways, roughs, and driving ranges will not be overseeded. The clubhouse lawn will be overseeded to annual ryegrass. This area will be fertilized monthly with a 24-0-0 nitrogen fertilizer.

Cutting heights will vary on these areas depending on their use. Fairways, driving ranges and the clubhouse lawn will be mowed as needed to maintain the grass at a height of one inch. The rough areas will be mowed to maintain grass at a height of four inches. Mowing will be scheduled so as not to remove more than one-half of the leaf surface at any one mowing.

Weed control on these areas will be accomplished through an annual spray program using Paraquat and 2-4-D. Spraying will be done in April each year.

4. Sand Traps. Sand traps on the courses will be raked daily. Reworking of individual traps will be scheduled as the need arises. Edges of the traps will be trimmed regularly to assure a neat appearance.

5. Drainage. Drainage is an important part of the golf course maintenance. To assure good playing conditions throughout the year, drains will be cleaned out and checked for maintenance needs on a monthly basis. Needed maintenance will be scheduled and accomplished as soon as possible.

6. Trees and Shrubs. The trees and shrubs growing on the golf courses enhance the beauty of the areas when properly maintained. Low tree limbs will be trimmed annually. Roots growing into the fairway will be cut each year. Shrubs will be trimmed as needed to maintain a neat appearance and uniform shape.

7. Special projects to be undertaken on the golf course area over the next ten years are as follows:

- a. Clear underbrush in wooded areas adjacent to the courses.
- b. Renovate the drainage system.
- c. Install improved watering system on the Scarlet course.

#### H. SOILS FOR RECREATIONAL DEVELOPMENT

Knowledge of soils is necessary in planning, developing and maintaining areas used for recreation. In the following tables the soils are rated according to limitations that affect their suitability for camp areas, playgrounds, picnic areas and paths and trails.

The table rates the soil as having slight, moderate, or severe limitations for the specified uses. For all of these ratings, it is assumed that a good cover of vegetation can be established and maintained. A limitation of slight means that soil properties are generally favorable and limitations are so minor that they easily can be overcome. A moderate limitation can be overcome or modified by planning, by design, or by special maintenance. A severe limitation means that costly soil reclamation, special design, intense maintenance, or a combination of

these, are required.

Camp areas are used intensively for tents and small camp trailers and the accompanying activities of outdoor living. Little preparation of the site is required, other than shaping and leveling for tent and parking areas. Camp areas are subject to heavy foot traffic and limited vehicular traffic. The best soils have mild slopes, good drainage, a surface free of rocks and coarse fragments, freedom from flooding during periods of heavy use, and a surface that is firm after rains but not dusty when dry.

Picnic areas are attractive natural or landscaped tracts used primarily for preparing meals and eating outdoors. These areas are subject to heavy foot traffic. Most of the vehicular traffic, however, is confined to access roads. The best soils are firm when wet but not dusty when dry; are free of flooding during the season of use; do not have slopes or stoniness that greatly increase cost of leveling sites or of building access roads.

Playgrounds are areas used intensively for baseball, football, badminton and similar organized games. Soils suitable for this use need to withstand intensive foot traffic. The best soils have a nearly level surface free of coarse fragments and rock outcrops, good drainage, freedom from flooding during periods of heavy use, and a surface that is firm after rains but not dusty when dry. If grading and leveling are required, depth to rock is important.

Paths and trails are used for local and cross-country travel by foot or horseback. Design and layout should require little or no cutting and filling. The best soils are at least moderately well drained, are firm when wet but not dusty when dry; are flooded not more than once during the season of use, have slopes of less than 15 percent, and have few or no rocks or stones on the surface.



*Soil properties which influence recreational developments are provided through soil survey interpretations.*

Table 6 .

## Interpretations for Selected Recreational Uses

Soil Series and Map Symbols	Degree of Limitations for Recreation			
	Camp Areas	Picnic Areas	Playgrounds	Paths and Trails
Baymeade 739 BA	Moderate- too sandy	Moderate - too sandy	Moderate - too sandy	Moderate - too sandy
Bibb BJ	Severe - flooding, wetness	Severe - flooding, wetness	Severe - flooding, wetness	Severe - flooding, wetness
Bladen 853	Severe— seasonal high water table, ponding	Severe - seasonal high water table, ponding	Severe - seasonal high water table, ponding	Severe - seasonal high water table, ponding
Capers CA	Severe - tidal flooding, high water table	Severe - tidal flooding, high water table	Severe - tidal flooding, high water table	Severe - tidal flooding, high water table
Corolla CD	Severe - seasonal high water table, too sandy	Severe - seasonal high water table, too sandy	Severe - seasonal high water table, too sandy	Severe - too sandy
Craven 558B 558C	Moderate - slow perme- ability	Slight - 0-3% slopes Moderate - 8-12% slopes	Slight - 0-6% slopes Moderate - 6-12% slopes	Slight
Duckston CD	Severe - high water table, too sandy	Severe - high water table, too sandy	Severe - high water table, too sandy	Severe - high water table, too sandy
Johnston BJ	Severe - flooding, wetness	Severe - flooding, wetness	Severe - flooding, wetness	Severe - flooding, wetness
Kureb 704 KL	Severe - too sandy	Severe - too sandy	Severe - too sandy	Severe - too sandy
Lakeland KL	Severe - too sandy	Severe - too sandy	Severe - too sandy	Severe - too sandy
Leon 582 LN	Severe - too sandy, seasonal high water table	Severe - too sandy, seasonal high water table	Severe - too sandy, seasonal high water table	Severe - too sandy, seasonal high water table
Lynchburg RL	Severe - seasonal high water table	Moderate - seasonal high water table	Severe - seasonal high water table	Moderate - seasonal high water table

Table 6 .

## Interpretations for Selected Recreational Uses

Soil Series and Map Symbols	Degree of Limitations for Recreation			
	Camp Areas	Picnic Areas	Playgrounds	Paths and Trails
Lynn Haven LM	Severe - seasonal high water table, ponding	Severe - seasonal high water table, ponding	Severe - seasonal high water table, too sandy, ponding	Severe - seasonal high water table, ponding
Murville LM	Severe - seasonal high water table, ponding	Severe - seasonal high water table, ponding	Severe - seasonal high water table, ponding	Severe - seasonal high water table, ponding
Newhan 708	Severe - too sandy	Severe - too sandy	Severe - too sandy, Severe where slopes > 6%	Severe - too sandy
Norfolk ON 365C	Slight - 0-8% slopes Moderate - 8-10% slopes	Slight - 0-6% slopes Moderate - 6-10% slopes	Slight - 0-2% slopes Moderate - 2-6% slopes Severe - > 6% slopes	Slight
Onslow ON 415	Moderate - seasonal high water table	Moderate - seasonal high water table	Moderate - seasonal high water table	Slight
Pactolus 460	Moderate - seasonal high water table, too sandy	Moderate - seasonal high water table, too sandy	Moderate - seasonal high water table, too sandy	Moderate - too sandy
Pamlico PM	Severe - wet, ponding	Severe - wet, ponding	Severe - wet ponding	Severe - wet, ponding
Pantego TP	Severe - seasonal high water table, ponding	Severe - seasonal high water table, ponding	Severe - seasonal high water table, ponding	Severe - seasonal high table water, ponding
Rains RL	Severe - seasonal high water table, ponding	Severe - seasonal high water table, ponding	Severe - seasonal high water table, ponding	Severe - seasonal high water table, ponding
Seabrook WA	Moderate - seasonal high water table, too sandy	Moderate - seasonal high water table, too sandy	Moderate - seasonal high water table, too sandy	Slight

Table 6

## Interpretations for Selected Recreational Uses

Soil Series and Map Symbols	Degree of Limitations for Recreation			
	Camp Areas	Picnic Areas	Playgrounds	Paths and Trails
Torhunta 870 TP	Severe - seasonal high water table, ponding	Severe - seasonal high water table, ponding	Severe - seasonal high water table, ponding	Severe - seasonal high water table, ponding
Wando WA 722	Moderate - too sandy	Moderate - too sandy	Moderate - too sandy	Moderate - too sandy
Woodington 833	Severe - seasonal high water table, ponding	Severe - seasonal high water table, ponding	Severe - seasonal high water table, ponding	Severe - seasonal high water table, ponding

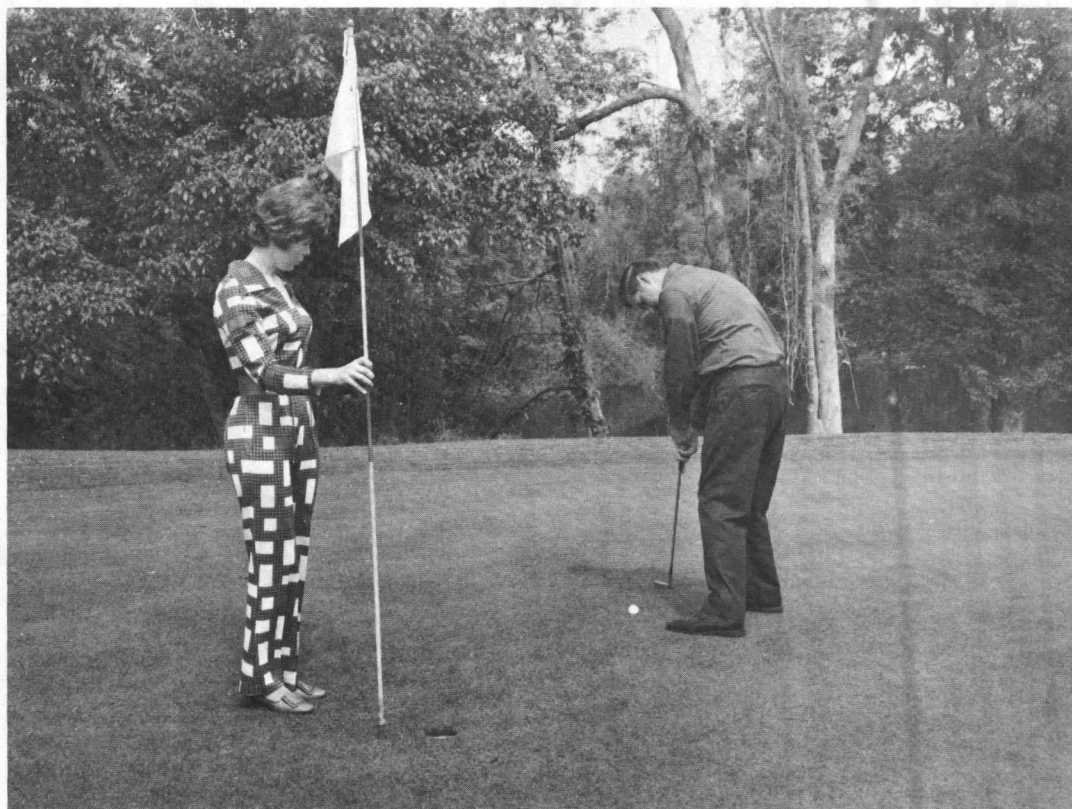

*Soil interpretations aid in plant selection and management on golf courses and other recreational facilities throughout the base.*







# FORESTRY

4-34552

FORESTRY

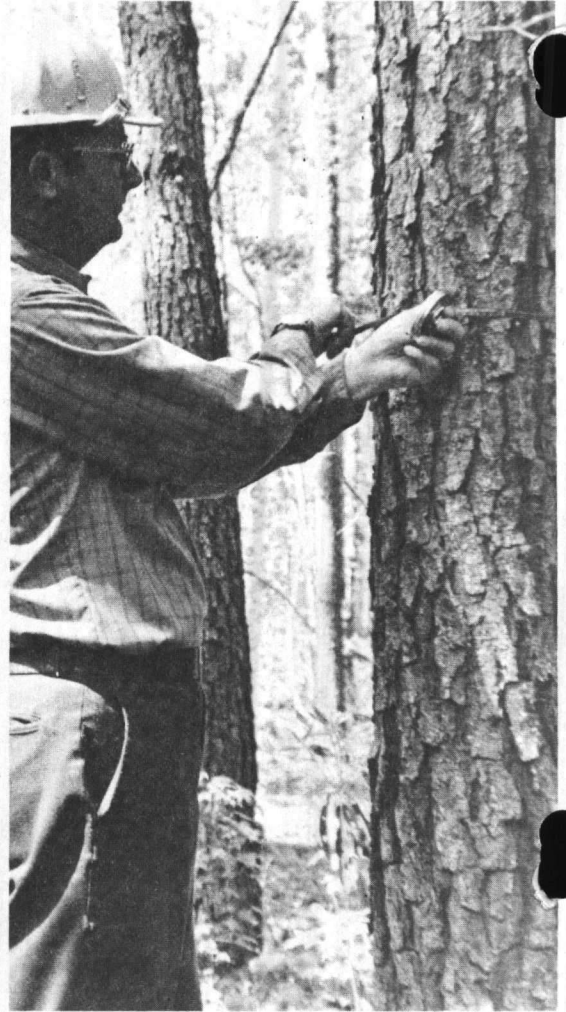

# FORESTRY MANAGEMENT PROGRAM

## A. INTRODUCTION

This forest management program has been designed to serve not only as a guide for professional land managers for the Marine Corps Base, Camp Lejeune, the New River Marine Corps Air Station (H), and the Marine Corps Helicopter Outlying Landing Field at Oak Grove but for others who are also concerned with the management of this vital, renewable natural resource. The program contains the necessary guiding principles for the orderly management of a multiple use forest. It is a ten-year plan of guidance with the necessary flexibility built in to cope with such unplanned events as insect epidemics, depressed lumber markets and military land use which would necessarily alter planned harvesting schedules. The forests at Camp Lejeune exist primarily to support the military mission's, field training and secondarily to provide for timber production, erosion control, wildlife habitat and a variety of recreational activities. This then, is multiple-use as managed.

## B. FOREST DESCRIPTION

1. Area. The total gross forest acreage is <sup>69,040</sup> 69,140 of which <sup>57,929</sup> 58,029 acres comprise the productive or net forest acreage. Streams, roads, ranges, permanent wildlife openings, food plots and roadside zones account for the difference between gross and net acreage.

2. Volume. The following volumes were obtained in 1973-74 by the use of a unique forest inventory method called the STX system. Its use was a military forestry "first" and involved the use of the STX computer program and an optical dendrometer, an instrument for measuring out-of-reach stem dimensions on standing trees. The STX method is more accurate, more efficient, more flexible and more consistent than earlier methods. Thus, the forest manager is furnished information and accuracy heretofore unobtainable at about one-third the cost of conventional methods. A statement of the present volume of timber in two different units of measure follows:

Present Cubic Foot Volume	-	91,083,945	<i>3.147</i>
Present Volume in MBF	-	286,700,301	<i>BF/CU.FT.</i>

The following tables give the forest manager more detailed information on the forest volume that is available. This facilitates the prescription of annual cuts and the prediction of work loads over a ten-year period.

TABLE #7

## VOLUME TABLE BY GROUP SPECIES IN CUBIC FEET, BOARD FEET AND BASAL AREA

Species Group	Cubic Foot Volume	Cubic Foot <i>PULP</i> wood Volume	Board Foot Volume	Basal Area
Southern Pine	58,887,113	18,144,063	246,948,295	2,097,270
Other Softwoods	219,918	—	—	—
Sweet Gum	4,375,931	2,710,304	7,468,176	61,167
Black & Tupelo Gum	5,707,615	3,638,916	9,668,653	91,550
Other Soft-Textured Hardwoods	4,209,759	2,075,099	9,884,606	85,873
Red Oaks	3,719,685	2,340,160	4,759,971	48,024
White Oaks	2,161,984	532,692	6,763,415	63,704
Other Firm-Textured Hardwoods	1,801,940	1,025,221	1,207,176	16,463
Non-Commercial Species	—	—	—	—
<b>TOTAL</b>	<b>91,083,945</b>	<b>30,466,455</b>	<b>286,700,292</b>	<b>2,464,051</b>

12,322.39 HOW  
1246 units/yr

39,752.00  
795,000  
MBF/yr

TABLE #8

## ACRES OF FOREST TYPES BY SIZE AND CLASS

Forest Type	Saw- Timber	Pole- Timber	Seedling Sapling	Non- Stocked	Total
Longleaf Pine	5,100	2,736	737	—	8,573
Slash Pine	14	—	464	—	478
Loblolly Pine	20,617	3,931	2,826	—	27,374
Pond Pine	2,589	1,481	1,264	—	5,334
Loblolly-Hardwood	6,387	627	41	—	7,055
Pond Pine-Hardwood	131	—	—	—	131
Scrub Oak	—	63	—	—	63
Sweet Gum-Water Oak	2,306	158	—	106	2,570
Elm-Ash	—	19	—	—	19
White Oak-Red Oak	1,207	24	—	—	1,231
Cypress-Tupelo	153	—	—	—	153
Black Gum-Red Maple	1,501	1,697	104	—	3,302
Non-Forested	—	—	—	1,746	1,746
<b>TOTAL</b>	<b>40,005</b>	<b>10,736</b>	<b>5,436</b>	<b>1,852</b>	<b>58,029</b>

TABLE 9

VOLUME & BASAL AREA BY DIAMETER CLASS OF EACH SPECIES GROUP

- Sawtimber in Board Feet -

DBH CLASS	SOUTHERN PINE		SWEET GUM		BLACK & TUPELO GUM	
	Volume Bd. Ft.	B A	Volume Bd. Ft.	B A	Volume Bd. Ft.	B A
10	12,202,957	252,800				
11	14,727,981	247,054				
12	8,144,873	215,454	1,186,686	14,364		
13	22,240,829	261,418			926,351	8,618
14	32,740,995	215,454			1,416,989	25,855
15	43,399,280	247,054	1,129,627	5,745	2,371,362	11,491
16	11,772,085	186,726	2,749,349	14,364		
17	45,721,408	166,618			1,089,197	8,618
18	17,998,835	106,291	544,149	11,491		
19	20,370,080	123,527	840,509	5,745	1,216,972	14,364
21	6,732,898	63,200	1,017,857	5,745	1,590,401	5,745
22	7,618,888	40,218				
23	3,277,245	8,618				
34					1,057,380	
TOTAL	246,948,350	2,134,432	7,468,176✓	57,454	9,688,653✓	74,691

DBH CLASS	OTHER SOFT TEXTURED HARDWOODS		RED OAKS		WHITE OAKS		OTHER FIRM TEXTURED HARDWOODS	
	Volume Bd. Ft.	B A	Volume Bd. Ft.	B A	Volume Bd. Ft.	B A	Volume Bd. Ft.	B A
12							198,606	5,745
13			237,263	11,491			433,649	8,618
14	309,736	17,237	453,318	20,109	1,012,156	5,745		
15	535,550	14,364						
16	619,698	5,745			884,144	5,745		
17			687,620	5,745				
18	1,790,964	8,618	1,120,176	8,618	1,775,621	11,491		
19	858,869	20,109	612,460	5,745	629,642	5,745	348,023	5,745
20	2,582,722	8,618					226,898	2,873
21					1,119,899	2,873		
22	1,013,206	2,873						
23					1,341,954	2,873		
25	2,173,861	5,745	796,600	8,618				
27			417,004	2,873				
32			435,531	2,873				
TOTAL	9,884,606✓	83,309	4,759,971✓	66,072	6,763,415✓	34,472	1,207,176✓	22,981

TABLE 9

## VOLUME &amp; BASAL AREA BY DIAMETER CLASS OF EACH SPECIES GROUP

- Pulpwood in Cubic Feet -

DBH CLASS	BLACK & TUPELO GUM		OTHER SOFTWOODS		SWEET GUM		SOUTHERN PINE	
	Volume Cu. Ft.	B A	Volume Cu. Ft.	B A	Volume Cu. Ft.	B A	Volume Cu. Ft.	B A
6							916,589	163,725
7	453,518	11,491	33,047	2,873	340,629	37,345	1,681,594	183,854
8	989,307	17,236					4,941,939	180,982
9	715,228	20,109			435,459	20,109	3,824,028	235,563
10							2,100,525	252,800
11	329,458	11,491	58,076	2,873	1,047,922	25,854	1,317,475	247,054
12			60,976	2,873	402,261	14,364	268,071	215,454
13	117,038	8,618					916,765	261,418
14	260,057	25,855			196,363	17,236	627,037	215,454
15	89,931	11,491	48,526	2,873	85,932	5,745	681,571	247,054
16					107,623	14,364	148,661	186,726
17	47,360	8,618					337,811	166,618
18					28,534	11,491	180,383	106,291
19	185,342	14,364			48,822	5,745	99,920	123,527
21	392,218	5,745			16,761	5,745	71,384	63,200
22							30,319	40,218
34	59,460	2,873						
TOTAL	3,638,917	137,891	200,626	11,492	2,710,305	157,998	18,144,072	2,889,938

DBH CLASS	OTHER SOFT TEXTURED HARDWOODS		RED OAKS		WHITE OAKS		OTHER FIRM TEXTURED HARDWOODS	
	Volume Cu. Ft.	B A	Volume Cu. Ft.	B A	Volume Cu. Ft.	B A	Volume Cu. Ft.	B A
7	257,301	40,218	347,861	25,854	192,375	14,363		
8	1,118,816	40,218						
9			946,685	40,218			133,243	11,491
10			153,323	2,873				
11							263,207	8,618
12	216,235	14,364	243,622	14,364			127,087	5,745
13			90,963	11,491			475,734	8,618
14	128,027	17,237	378,234	20,109	57,155	5,745		
15	67,326	14,364						
16	67,555	5,745			39,773	5,745		
17			13,250	5,745				
18	25,697	8,618	79,081	8,618	172,518	11,491		
19	24,263	20,109	19,951	5,745	16,925	5,745	7,985	5,745
20	55,326	8,618					17,964	2,873

(continued)

DBH CLASS	OTHER SOFT TEXTURED HARDWOODS		RED OAKS		WHITE OAKS		OTHER FIRM TEXTURED HARDWOODS	
	Volume Cu. Ft.	B A	Volume Cu. Ft.	B A	Volume Cu. Ft.	B A	Volume Cu. Ft.	B A
21					53,947	2,873		
22	16,847	2,873						
23	72,710	8,618						
25	24,995	5,745	11,389	8,618				
27			24,533	2,873				
32			31,268	2,873				
TOTAL	2,075,099	186,727	2,340,161	149,381	532,692	45,962	1,025,220	43,090



*Annual growth measurements of commercial species of trees are mandatory in forest management.*



3. Growth. The ultimate objective of a managed forest is sustained yield or simply, growth equals cut. Growth was determined from samples taken from 219 trees and calculated by the STX computer. The following computations show the forest growth rate over the past five years.

Present cubic foot growth	91,083,945
Past five years cubic foot growth	<u>70,202,805</u>
Cubic foot growth in five years	20,881,140
Percent growth in five years	22.93%
Percent growth in one year	4.58%
Present board foot growth	286,700,292
Past five years board foot growth	<u>215,646,200</u>
Board foot growth in five years	71,054,092
Percent growth in five years	24.78%
Percent growth in one year	4.95%

These statistics indicate that the growth harvest rate is well balanced and a continuation of such is expected unless emergencies such as insect infestations, diseases or salvage of fire damaged timber render an offset.

4. Annual Allowable Cut. The annual allowable cut is an estimated volume that may be harvested through sustained yield management based on the present inventory volume and growth rates. In computing the annual allowable cut Von Mantel's method was used. It is as follows:

$$\text{Allowable Cut} = \frac{\text{Inventory Growing Stock}}{\text{Average Rotation}/2}$$

The annual allowable cut is estimated at 8,200 MBF Scribner log rule and 20,300 cords of pole sized products including sawtimber topwood. The allowable cut usually is not fully attained within Marine Corps policy of restoring and improving forests to their maximum level of productivity and timber quality due to the following reasons:

- a. Meet the necessary needs of providing adequate habitat for the various species of wildlife, deer, grey squirrel, fox squirrel, quail, black bear, turkey and other game and non-game species when hundreds of acres must be involved in this type of management.
- b. Meet the military obligations when sites have to be reduced in stocking or cleared for structural or training purposes.
- c. Support recreation and aesthetic areas at various locations on the base. Included in this would be streamside zones where hardwood species receive a planned light harvest so that soil erosion and pollution may be reduced.

C. MANAGEMENT CHANGES

*EVEN-AGED  
SUSTAINABLE YIELD  
MULTIPLE USE  
SYSTEM*

1. Forest Management System. Definite changes are being made in the base even-age forest management system. Not only is the forest being managed to produce a maximum growth of pine fibre, but management is being carried out to produce more hardwoods on branches, streamside areas and intermingled with pine species where soil site index will permit sufficient growth. This encouragement in hardwood growth is not only to increase hardwood forest products but also to assist in establishing a better wildlife habitat, and to reduce the monoculture pine type that exists on much of the area. This hopefully will reduce the southern pine beetle that has continually plagued this forest since 1967. Areas that are very low in site productivity varying in size from 5-8 acres and stocked with scrub oak are being left in scattered patterns through the woods. This is for the promotion of dusting areas, bugging areas, natural openings and food production areas for various wildlife species. The continuous forest inventory program has changed to the 3-P Forest Inventory System which is computerized, very accurate and reduces the time of inventory by at least two thirds. (This method was previously described in Section B, 2.) Management of timber stands is also being changed due to logging methods now being applied. The intermediate cut is still used in old field and thickly stocked open pine forest stands; clearcuts (averaging approximately 50 acres in size) are being employed in sparsely stocked pine stands, mature and over mature pine stands; seed-tree cuts are becoming more prevalent (averaging approximately 50 acres) where the existing seed source is acceptable by phenotype characteristics of standing trees, especially in mature and over mature pine stands. Hardwood stands are being managed to become more balanced in species or forest types and eventually even-age management. No clearcuttings and seed-tree cuttings are planned during this cycle for hardwoods except under emergency conditions.

In keeping with the base pollution policies, contract loggers are required by contract to bury or remove all debris to the sanitary landfill. All oil changing is required to be covered and definitely not allowed to drain into streams or creeks. Camping areas for recreational facilities are being constructed throughout the forest, particularly along the Inter-coastal Waterway and creeks large enough for fishing. Buffer zones of approximately 150 feet will be left around these areas. Bridal paths for horseback riding on timber access roads are favored by staggering timber cutting around the base stables. Endangered species habitat that would be affected by timber harvests (e.g. red-cockaded woodpecker nesting trees, trees containing osprey nests and trees serving as beehives) is being managed for the protection of these species. With the changes being made in the management system, it can be definitely stated that this is truly a multiple-use forestry program.

2. Logging Methods. Since the tree length logging method began and mechanized high-speed logging equipment has been brought into use, various changes have been made in logging methods. In intermediate cuts some damage has been rendered to remaining growing stock by skidding equipment through circular movements in the standing growing stock. Also, no definite patterns or skid lanes have been followed. This will be prohibited through a restrictive clause in the timber sale contract. Also, bunching and loading decks will be located for the logger and situated off the roadside so as to leave roads and ditches free of debris. No skidding of cut timber will be allowed in access drain ditches, across and down gravel roads, nor

across intermittent or live streams. No tops will be left in streams. Timber access roads will be maintained and left open for use in as good or better condition than before the logging operation commenced. All bunching and loading sites for clearcut and seed-tree areas will be located as in intermediate cut areas. In seed-tree areas, skidding of felled timber will be kept away from seed-trees as much as possible as to insure a minimum of trunk and root system damage.

D. OBJECTIVES

The objective of the forest management plan is to eventually reach and maintain an even-aged system of pine and hardwood species through which the maximum amount of fibre is produced and multiple-use management is strengthened in all phases so that the forest meets all the needs for military training as well as phases required by environmental requirements.

E. MANAGEMENT PLAN

1. Compartment Examination. Compartment examinations will normally be made once during this ten-year cutting cycle. This will be during the fiscal year as prescribed in the Work Schedule, Section H of this plan unless an emergency occurs; e.g., insect attacks, disease damage, fire damage or military requirements. If the compartment examinations are detained for any reason other than planned, an amendment to the Work Schedule will be prepared and all parties concerned will receive a copy of the amendment.

2. Annual Cut. The annual cut is a flexible figure which is influenced by stand prescription for stands in compartments to be examined that fiscal year for harvest and or emergency situations that may arise, e.g., insect infestations, disease damage, wildfire damage and military requirements.

3. Modified Cut Areas. Areas that will receive modified cutting are located in the following categories:

a. Roadside (aesthetic) zones along major transportation arteries - 200 foot zone on either side of Holcomb and Brewster Boulevards; 50 foot zone along either side of Sneads Ferry Road from Holcomb Boulevard to Main Service Road; 50 foot zone on either side of Lyman Road to TLZ Penguin; 50 foot zone north of Industrial Area along developed area to Wallace Creek; 50 foot zone on either side of Stone and Charles Streets; 50 foot zone on either side of Montford Point Road around the building complex; 50 foot zone between Highway 24 and railroad from Northeast Creek to Camp Knox Road; 100 foot zone between Highway 24 and compartment one or powerline on northeast end; 50 foot zone around schools or athletic fields; 50 foot zone on either side of Curtis (MCAS) Road; 50 foot zone around Force Troops Complex; 50 foot zone around Rifle Range Complex including Correctional Custody Complex at Rifle Range; 50 foot zone around Courthouse Bay and Boat Basin (Amtrac Area) where applicable.

b. Streamside zones along all live streams usually not lower than middle to upper slope. No tops allowed to remain in streams along New River, leaving a 50 foot zone from edge of bank.

200 ft.  
ROADZONE  
ON ALL  
HARD-  
SURFACE  
ROADS.

- c. Recreational Area zones 150 foot zone around all camping areas. This zone may be thinned if basal area is above 80.
- d. Industrial and Housing Area zones usually are 50 foot zones and will be maintained around subject areas; however, zone boundary lines may vary due to location and stand type.
- e. Fish Pond zones 100 foot zones will be maintained around natural and man-made fish ponds. This zone boundary may vary depending upon timber type.
- f. Golf Course zones 150 foot zone will be maintained behind and around Course #1. Course #2 has no timber to give zone affect.
- g. School zones 50 foot zone will be around shcool areas or athletic areas adjoining the schools.

Modified cuttings such as removal of overmature timber, insect or disease infected timber, lightning strikes and fire damaged timber may be removed from these zones when deemed necessary.

4. Reforestation. Areas as needed will be reforested by natural (seed-tree method) or artificial (planting by dibble or machine). Reforestation will normally be done during the winter months immediately following site preparation, but planting will not be done any earlier than one year after harvest due to pales weevil (*hylobius pales*) damage to seedlings. Natural regeneration may not occur until the second year after site-preparation, depending upon the quantity of seed produced during the first year. All areas that have been stripped for borrow pits, former ranges and training sites that are abandoned and old dumps that have been closed will be planted in pine. Planting will normally be done by contract labor each year; this contract should begin on or about 1 December (just after site preparation is completed) and end in April of the following year depending upon the amount of seedlings to be planted and weather conditions. Pine seedlings will normally be 1 - 0 year stock and will be purchased from the North Carolina State Forest Service Nursery, Goldsboro, North Carolina. A contract for the amount and species of seedlings to be planted should be submitted to the nursery in August preceding the year on which planting is to be done. Seedlings will be picked up from the nursery at intervals depending upon how fast planting operations proceed and will be stored in the base Cold Storage Section. Seed-trees will be removed from the seed-tree cut areas as soon as the area is considered adequately stocked so that damage to the young growing stock will be kept to a minimum.

5. Timber Stand Improvement. Timber stand improvement is normally carried out in the two following ways:

- a. Prescribed Burning - Prescribed burning is done mainly for these four reasons:
  - (1) Reduce litter build-up in pine stands so that the occurrence and damage of wildfires will be reduced.
  - (2) Control undesirable species that are weed species in the forest crop and of little or no value to wildlife.

(3) Improve wildlife habitat by opening the forest floor for better foraging and browsing and so that wildlife can move about more freely.

(4) Control brown-spot fungus that attacks longleaf pine while it is in the "grass stage." This is the only known control.

The prescribed burning plan is shown under Work Schedule, Section H of this plan.

b. Site Preparation - This operation is carried out after either a seed-tree or clearcut has been made, or as former areas used for military training or other areas of use are released for forest management. This work is done by use of a KG blade. The blade shears off almost all undesired species and stumps at ground level. The debris on sale areas is windrowed and later burned if time and weather permit. Windrows are staggered around seed-trees so that fire damage to the seed-trees are reduced and later removal of trees are more easily accomplished. Disking (single or double cutting) with a  $2\frac{1}{2}$ -4 ton tandem disk is sometimes done to improve site preparation particularly, on those areas having a thick organic surface layer or on open field areas. Windrow burning will be done during summer months before seed fall or planting has begun. Site preparation will begin after the timber has been harvested so that the build up of hardwood sprouts will be controlled or eliminated. The work schedule, section H of this plan gives the site preparation plan for each compartment. In the event a change should arise, the scheduled work will be adjusted accordingly. Site preparation will be commercially contracted each year unless the acreage is considered to be small enough that the Heavy Equipment Branch of the Maintenance Repair Division can accomplish the work in time to meet the schedule of work. Other mechanical methods of site preparation may be used if justified.

6. Insect and Disease Prevention and Control. There has been little or no problem with forest tree diseases other than an endemic stage of root rot (*Fomes annosus*) in old field loblolly pine stands. In the event a disease should begin and identification methods of control cannot be determined by base foresters, the North Carolina State Forest Service, Raleigh, North Carolina will be asked to assist. The same procedure will be followed for insect infestations. There have been prolonged attacks from epidemic to endemic proportions by the southern pine beetle (*Dendroctonus frontalis*) and endemic problems with the black turpentine beetle (*Dendroctonus terebrans*). The best recommended control method for the southern pine beetle is to salvage all infested timber as soon as possible including a 100 foot wide boundary around the infested area.

Salvage authorization will be given in the timber sales contract. If a negotiation is needed for salvaging isolated attacked areas, the timber sale contract will stipulate such a need. In the event southern pine beetle attacks occur in nonmerchantable stands, the trees will be felled, cut up, piled and burned as soon as possible to prevent further spreading. If trees become weakened with black turpentine beetle attack, they will be treated in the same manner as southern pine beetles. With an increase in seed-tree and clearcutting operations it is important that bordering stands be kept under observation after the harvesting begins. If means of detecting beetle outbreaks are needed from time to time, a request will be made through the Director of the Natural Resources and Environmental Affairs Division for helicopter flights to assist in the location of the attacked areas.

7. Fire Control. The Forestry Branch coordinates with the Base Fire Department for fire protection and control through Base Order 11320.1E as amended. All necessary procedures for fire control are given in this Base Order. A prescribed burning program has been previously described under Timber Stand Improvement, Subsection 5 a.

#### F. REGULATIONS

1. Control. Marine Corps Order P11000.8, dated 17 April 1972, Marine Corps Order 6240.4, dated 26 May 1971 and NAVFAC Instructions 11015.9A, dated 23 January 1973 as amended, contains the regulations under which this plan is developed and carried out.

2. Silviculture. This plan is written as a guideline for eventually bringing the forest under even-aged management on a multiple-use basis. The end product of each operable stand at the end of the species' rotation age is sawtimber with the exception of roadside aesthetic areas and zones, streamside zones, golf course boundaries, school and housing areas and ponds. When trees in these areas begin to show maturity and/or over maturity, they shall be removed at intervals so as to insure the aesthetic value. Hardwood mast producing trees for wildlife will also be left throughout all adaptable areas after attaining the species' rotation ages.

3. Rotation Age. The rotation age for pine is 60 years and 80 years for hardwoods. The rotation will be divided into six cutting cycles covering a ten-year period.

#### G. USE OF SOIL INTERPRETATIONS IN WOODLAND PROGRAMS

Good stands of commercial trees are produced in the woodlands of the base. Needleleaf forest types occur most frequently on upland and terrace and broadleaf types generally predominate on the bottoms along the rivers and creeks.

The value of the wood products is substantial. Other values include wildlife, recreation, natural beauty and conservation of soil and water. This section has been provided to explain how soils affect tree growth and forest management. In table 10 potential productivity and management problems of the soils at Camp Lejeune are listed.

The first column list the mapping unit symbol for the soils. The second column list the class determining phases of the mapping unit.

The next column gives the woodland ordination group. Each group is made up of soils that are suited to the same kinds of trees that need about the same kind of management to produce these trees and that have about the same potential productivity.

Each woodland ordination group is identified by a three part symbol. The first part of the symbol indicates the relative productivity of the soils: 1 - very high; 2 - high; 3 - moderately high; 4 - moderate and 5 - low. The second part of the symbol, a letter, indicates the important soil property that imposes a moderate or severe hazard or limitation in managing the soils for wood production. The letter w shows that excessive water in or on the soil is the chief limitation; s shows the soils are sandy; and o shows that the soils have no significant restrictions or limitations for woodland use or management. The third element of the symbol indicates the general suitability of the soils for certain kinds of trees.

The management problems evaluated in columns 5, 6 and 7 are erosion hazard, equipment limitations and seedling mortality. Erosion hazard measures the risk of soil losses in well-managed woodland. Erosion hazard is slight if expected soil loss is small, moderate if some measures to control erosion are needed in logging and construction and severe if intensive treatment or special equipment and methods are needed to prevent excessive soil losses.

Equipment limitation ratings reflect the soil conditions that restrict the use of equipment normally used in woodland management or harvesting. Slight ratings indicate equipment use is not limited to kind or time of year. A rating of moderate indicates a seasonal limitation or need for modification in methods or equipment. Severe limitations indicate the need for specialized equipment or operations.

Seedling mortality ratings indicate the degree of expected mortality of planted seedlings when plant competition is not a limiting factor, Normal rainfall, good planting stock and proper planting are assumed. A slight rating indicates expected mortality is less than 25 percent. Moderate rating indicates a 25 to 50 percent loss; and severe indicates over 50 percent loss of seedling.

In the eighth column is a list of some of the commercially important trees which are adapted to the soil. These are the trees which woodland managers will generally favor in intermediate or improvement cuttings. Also given is the potential productivity of these trees in terms of site index. The site index is the average height of dominant trees, in feet, at age 30 for cottonwood; at age 35 for sycamore; at age 25 for planted pines; and at age 50 for all other species or types.

In the last column is a list of trees suitable to plant for commercial wood production.



*Special wide-tired equipment is required for tree harvest on sites having certain soil restrictions.*

Table 10

## WOODLAND SUITABILITY INTERPRETATIONS

1. 25 yrs. PLANTED Pine
2. 30 yrs. COTTONWOOD
3. 35 yrs. SYCAMORE
4. 50 yrs. ALL other species.

Soil Series and Map Symbols	MANAGEMENT PROBLEMS					POTENTIAL PRODUCTIVITY		
	Class Determining Phase	Ordination Symbol	Erosion Hazard	Equipment Limitations	Seedling Mortality	Important Trees	Site Index	Trees to Plant
Baymeade BA 739	All	3s2	Slight Small SOIL LOSS	Moderate SEASON LIMITATION	Moderate	Loblolly Pine Slash Pine Longleaf Pine	80 80 65	Loblolly Pine Slash Pine Longleaf Pine
Bibb BJ	All	2w9	Slight	Severe need SPECIALIZED EQUIPMENT	Severe 75% SEEDLING LOSS	Loblolly Pine Sweetgum	92 <sup>+</sup> 7 90 <sup>+</sup> 9	Loblolly Pine Sweetgum Sycamore
Bladen 853	0-2% (Un- drained)	2w9	Slight	Severe	Moderate 25% TO 50% SEEDLING LOSS	Loblolly Pine Slash Pine Sweetgum Tupelos Red Oaks White Oaks	90 90 90	Loblolly Pine Slash Pine Sycamore
Capers CA	All					Unsuited for trees		
Corolla CD						None		
Craven 558B 558C	All	3w2	Slight	Moderate	Slight 225% SEEDLING LOSS	Loblolly Pine Longleaf Pine Water Oak	81 67 80	Loblolly Pine Slash Pine
Duckston CD						None		
Johnston BJ	All	1w9	Slight	Severe	Severe	Loblolly Pine Sweetgum Water Oak	97 111 103	Loblolly Pine Slash Pine Bald Cypress Yellow Poplar Sweetgum Green Ash Water Tupelo
Kureb KL 704	All	5s3	Slight	Severe	Severe	Longleaf Pine Slash Pine	50 60	Longleaf Pine Slash Pine
Lakeland KL	All	4s2	Slight	Moderate	Moderate	Slash Pine Loblolly Pine Longleaf Pine	80 80 70	Slash Pine Loblolly Pine
Leon LN 582	0-5%	4w2	None	Moderate	Moderate	Loblolly Pine Slash Pine Longleaf Pine	75 75 60	Loblolly Pine Slash Pine



Table 10

## WOODLAND SUITABILITY INTERPRETATIONS

Soil Series and Map Symbols	MANAGEMENT PROBLEMS					POTENTIAL PRODUCTIVITY		
	Class Determining Phase	Ordination Symbol	Erosion Hazard	Equipment Limitations	Seedling Mortality	Important Trees	Site Index	Trees to Plant
Lynchburg RL	All	2w8	Slight	Moderate	Slight	Slash Pine Loblolly Pine Longleaf Pine Yellow Poplar Sweetgum Red Oaks White Oaks Blackgum	91 <sup>+</sup> <sub>4</sub> 86 <sup>+</sup> <sub>4</sub> 75 <sup>+</sup> <sub>5</sub> 92 90	Slash Pine Loblolly Pine Yellow Pine
Lynn Haven LM	0-2%	3w2	None	Moderate	Moderate	Slash Pine Loblolly Pine Longleaf Pine	80 80 70	Slash Pine Loblolly Pine
Murville LM	All	2w2	Slight	Severe	Severe	Loblolly Pine Slash Pine	90 90	Loblolly Pine Slash Pine
Newhan 708						None		
Norfolk ON 365C	All	2o 1 No	Slight	Slight	Slight	Loblolly Pine Longleaf Pine Slash Pine	86 68 86	Slash Pine Loblolly Pine
Onslow ON 415	All	2w8	Slight	Slight	Slight	Loblolly Pine Slash Pine Longleaf Pine	76 80 67	Slash Pine Loblolly Pine
Pactolus 460	All	3w2	Slight	Moderate	Moderate	Loblolly Pine Longleaf Pine Slash Pine	84 70 83	Loblolly Pine Slash Pine
Pamlico PM	All	4w3	Slight	Severe	Severe	Slash Pine Pond Pine Bald Cypress Water Tupelo	70 55	Slash Pine
Pantego TP	All	1w9	Slight	Severe	Severe	Loblolly Pine Slash Pine Pond Pine Bald Cypress Water Tupelo Water Oak	98 95 73	Loblolly Pine Slash Pine Sweetgum Sycamore Water Tupelo
Rains RL	All	2w3	Slight	Severe	Severe	Loblolly Pine Slash Pine Sweetgum	94 91 90	Loblolly Pine Slash Pine Sweetgum Sycamore
Seabrook WA	All	2w8	Moderate <i>Some measure of control needed</i>	Moderate	Moderate	Loblolly Pine Slash Pine Longleaf Pine	90 90 69	Loblolly Pine Slash Pine

Table 10

## WOODLAND SUITABILITY INTERPRETATIONS

Soil Series and Map Symbols	MANAGEMENT PROBLEMS					POTENTIAL PRODUCTIVITY		
	Class Determining Phase	Ordination Symbol	Erosion Hazard	Equipment Limitations	Seedling Mortality	Important Trees	Site Index	Trees to Plant
Torhunta TP	All	2w9	Slight	Severe	Severe	Loblolly Pine Slash Pine Sweetgum Water Tupelo	90 86 90	Loblolly Pine Sweetgum Slash Pine Sycamore Shumard Oak
Wando WA 722	1-4%	3s2	Slight	Moderate	Moderate	Longleaf Pine Loblolly Pine	70 <sup>±</sup> 1 79	Loblolly Pine Slash Pine Longleaf Pine
Woodington 833	All	2w9	Slight	Severe	Severe	Slash Pine Loblolly Pine Sweetgum Water Oak Longleaf Pine Tupelos	93 <sup>±</sup> 5 90 90 90 71 <sup>±</sup> 1	Slash Pine Loblolly Pine Sycamore Water Tupelo



*Soil qualities and topography influence timber stand types. Drainageways are usually at higher elevations.*

H. WORK SCHEDULE FROM 1975 - 1984

The following work schedules were prepared as a continuation of treatment to compartment stands as prescribed in the initial ten-year management plan. Compartments 13, 15, 31, 45, 33 and 60 were not treated as prescribed in the first management plan due to a southern pine beetle infestation from 1967 - 1970 throughout the base. Therefore, they are placed for treatment during the first year of this plan. The schedule below is adequate for long range planning since in this area of fast timber growth and land use changes compartment prescriptions made now may not be applicable during scheduled treatment year. For this reason compartment stand prescriptions will be general and are to be represcribed prior to treatment. The following schedules are projected and will be subject to changes as prescriptions indicate changes are needed.

<u>FISCAL YEAR</u>	<u>COMP'T</u>	<u>STAND</u>	<u>ACRES</u>	<u>DATES</u>
1975	13 complete	1,2,3,4,5,6,7,8,9	821	MAY 79 July 1974 (US)
		10, 11		June 1975
	15 complete	1,3,4,6	623	AUGUST 78 (TT CONTRACT)
	31 MARKED	2,3,5,6,7,8,10	881	Sold
	45 MARKED	1,2,3,4,5,6,7,9,10		
		14, 16	1,055	Sold
	33 MARKED	1,2,7,11	190	Sold
	60 MARKED	2,4,5,6,7,8,11	644	Sold
	34 COMPLETE			
			4,214	
	<u>Acres to Cut</u>			
	<u>Prescribed Burning</u>	3,5,16,21,22		
		23,26,39,40		
		42,44,49,61	8,878	December 1974
		all ranges		February 1975
	<u>Site Preparation</u>	2,15,17,18,20		
		39,45,47	419	June 1975
		21, 42, 43, 44, 47, 50, 56, 58, 459	800 AC.	September 1975
	<u>Reforestation</u>			
	(Natural & Artificial)			
		2,15,17,18,20		
		39,45,47	419	October 1974
				March 1975
	<u>Erosion Control and/or Wildlife Betterment</u>			
		19,28,36,41,46	8	Spring 1975

*1977 Timber purchase only*

*IN RESEARCH AREA MOVE to FY 78*

*PRESCRIBED*

*18 Sold*

*SOLD FY-76*

*Summer 78*

*THIS IS THE ONLY THING WE HAVE KEPT UP WITH SINCE THE S.P.B. OUTBREAK*

*SOUTHERN PINE BEETLE ACREAGE*

*NOT BURNED*

*441 DISCED by HEAVY EQUIP. ADDAC. 800 AC.*

*Completed FY-75*

FISCAL YEAR

1976

1978  $\rightarrow$  Prescription  
prespos only

37 FROM  
MARKED  
FY-85

CONTRACT  
C-30  
CONTRACT  
C-69

#61

TO F.Y. 85  
59  
61  
37

COMP'T

STAND

ACRES

DATES

Summer 77

✓6 COMPLETE

3,4,5,7,9,10,11,12

425 MAY 78 (U.S.)

14,15,16

July 1975

1,2,4,5,9,10,12,13

577 JUNE 78 (77 CONTRACT)

1,4,5,8,10,14

672 FEB 79 (77 CONTRACT)

1,2,3,5,6,7,8,10

950 NOV 79 (78 CONTRACT)

11,12,13,14,15,16

433 Sept. 78 (77 CONTRACT)

1,3,4,8,13,14

913 APRIL 79 (78 CONTRACT)

1,2,3,4,5,6,7,8,9

765 TO F.Y. 85

1,2,3,4,5,6,7,9

10,12,13,14,15

Oct. 79 (U.S.) Summer 78

Acres to Cut

4,735

Prescribed Burning

2,7,11,17,20

50 MILES PLOWED

24,29,34,35

37,47,57,61

all ranges

December 1975

Site Preparation

1,4 and other

all other  
S.P.B. spots

cut areas nec-  
essary

7,994

February 1976

682

7,312

(17,11,24)

284

June 1975

October 1975

Reforestation

(Natural & Artificial)

1, 4 areas at Montford Point  
areas at TT & Camp Knox and  
other cut areas necessary

318

October 1975

March 1976

Erosion Control and/or Wildlife Betterment

12,30,48,50,59

9

Spring 1975

CHECK F.Y. '75  
planting &  
F.Y. '75 SEED TREE  
AREAS IN C1 + C4  
FOR SURVIVAL.

DISCING  
CHOPPING

FISCAL YEAR

1977 1979

Contract 16 + 49

35  
FROM FY. 88  
BECAUSE OF  
QUALITY  
MANAGEMENT  
Complete  
6/22  
6/21  
80

Not burned FY. 76  
Ac.  
Compt. → 350  
11 → 311  
17 → 21  
24 → 682

#1

Acres to Cut

Prescribed Burning

85 MILES

NOT BURNED  
BECAUSE  
OF TREE  
SALE

Site Preparation

REMAINING  
S.P.B. ACCRAGE

15.18

60 WAS  
DROPPED BECAUSE OF  
NATURAL REGENERATION

Reforestation

(Natural & Artificial)

Erosion Control and/or Wildlife Betterment

COMP'T	STAND
5	1,5,7,8,9,10,12,14
16	15,16
21	2,3,4,5,6,7,8,9
23	2,4,5,7,8,9,11
26	2,3,4,5,6,8,10,11
27	12,15,17
49	1,2,4,5,7,9,10
35	1,3,4,5,6,7,8,9,10
35	11,12,13

ACRES

DATES

751	TO FY. 78 July 1976
	June 1977
793	MARCH 77 (CONTRACT 78)
392	CONTRACT 78
907	FEB 80 (US) Summer 79
804	July 79 (CONTRACT 79)
809	JAN. 79 (CONTRACT 78)
	July 78 (CONTRACT 77)

4,456

7,729

456

456

8

December 1976  
February 1977

June 1977  
October 1977

October 1977  
March 1978

Spring 1977

FISCAL YEAR

1978 1980

CONTRACT C-11

Comp 4. 5

FROM FY-79

THE NORTHERN SECTION IS QUARK MANAGEMENT AREA BUT IT WAS ALREADY SCHEDULED FOR THIS YEAR SO NO ARRANGEMENTS WERE NECESSARY.

COMP'T

MARK F-245  
7 ★

CONTRACT (11)  
MARK F-1224 ★  
77 (34)  
70 FY. '78 (34)

STAND

ACRES

DATES

1,3,4,5,6,7,8

842 AUG 79 July 1977 (CONTRACT 79)

1,2,3,4,5,6,7,8

956 DEC-79 June 1978 (CONTRACT 78)

1,4,6,7,9,10,11

700 SEPT. 79 (CONTRACT 79)

1,4,5,6,7,8,10

462 SOLD FY-78 (AS. SUMMER 77)

4,5,6,7,9,11,12

783

13,14,15

57 ★ 1,2,3,4,5,6,7,8

637 OCT. 80 (CONTRACT 79)

9,10,11

NOV. 80 (CONTRACT 79)

Acres to Cut

4,300

Prescribed Burning

13,15,19,28

31,43,33,36

41,46,54,60

all ranges

7,833

December 1977

February 1978

Site Preparation

6,12,48,59

area behind Salvage Lot 18,  
old dump in 55, near Courthouse  
Bay area, west of Mile Hammock  
Ramp and 61 and other cut areas  
necessary

415

June 1978

October 1978

Reforestation

(Natural & Artificial)

6,12,48,59,61 areas behind  
Salvage Lot 18, old dump at  
Courthouse Bay area, west of Mile  
Hammock Bay and other cut areas  
necessary

415

October 1977

March 1978

Erosion Control and/or Wildlife Betterment

7,24,34,35,57

8

Spring 1978

NOT BURNED FY-77  
Comp. AC.  
18 76t

① 18  
② 1

76 MILES  
T&K SALES  
MOVE TO  
FY-79

③ 4

10 STDS 8-10  
1158

SEED TREES IN  
31,33,6

NOT BURNED  
FY-77 BECAUSE  
OF THE SALE  
BURN C-30  
35 BECAUSE MAIL  
MAY BE 57 BUT WE SHOULD MARK

SOME OF THIS COULD BE  
DONE IN 79 BUT WE  
WANT WHAT 1980 PRESCRIPTIONS  
SAY.



<u>FISCAL YEAR</u>	<u>COMP'T</u>	<u>STAND</u>	<u>ACRES</u>	<u>DATES</u>	
1980	PM 19	2,3,6,7,8,12,15 17, 19	632	July 1979 June 1980	Summer 79 U.S. CONTRACT 80
	PM 28 ★	1,2,3,4,5,7,9,10 11,12,13,14,16	908	OCT. 28	CONTRACT 80
	PM 36	2,3,4,5,6,7,8,9 11,12,13	904	MAY 80	U.S. Summer 79
	H/ 41 ★	1,2,3,4,5,6,7,8	972	NOV. 80	CONTRACT 80
	H/ 46	1,2,3,4,5,6,7,9 10,11,12,15	1,314	DEC 80	U.S. Summer 80
	54	1,3,4,7,8,14,15	631	JAN-80	U.S. Summer 80
	<u>Acres to Cut</u>		5,361		
	<u>Prescribed Burning</u>	3, 5, 16, 21, 22, 15 23, 26, 39, 40, 42, 48 44, 49, 61, all ranges		December 1979 February 1980	
	<u>Site Preparation</u>	7, 24, 34, 35, 57 and any cut areas necessary	300	June 1980 September 1980	
	<u>Reforestation</u> (Natural & Artificial)	7, 24, 35, 57, 34 and any cut areas necessary	300	October 1979 March 1980	
	<u>Erosion Control and/or Wildlife Betterment</u>	13, 15, 45, 33, 60	8	Spring 1980	

6, 21, 22, 15  
23, 26, 39, 40, 42  
44, 48, 49, 61, 12

TO FY-79 54  
FROM FY-79  
TO FY-79  
FROM FY-79  
FROM FY-78



FISCAL YEARCOMP'TSTANDACRESDATES

1981

14 ★ 2,4,6,7,8,9,12  
 27 ★ 1,3,4,6,7,8,9  
 11,12  
 38 1,4,6,7,8,9,10  
 11,13,14  
 PIC 43 ★ 1,4,5,6,8  
 P 51 2,9,10  
 PM 53 ★ 2,3,4,5,6,8,9  
 11,13

932 MARCH 81 July 1980 CONTRACT 81  
 998 APRIL 81 June 1981 CONTRACT 81  
 752 SEPT. 81 U.S. (Summer 81)  
 592 MAY 81 CONTRACT 81  
 350 FEB. 81 U.S. (Summer 80)  
 806 JUNE 81 CONTRACT 81

Acres to Cut

4,430

Prescribed Burning 2,7,11,17,20

TO FROM  
 FROM 24, 29, 34, 35  
 37,47,57, and all ranges

7,766

December 1980  
March 1981

Site Preparation 25,62 and necessary cut areas

200

June 1980  
October 1980

Reforestation

(Natural &amp; Artificial)

25, 62 and other areas needed

200

December 1980  
March 1981

Erosion Control and/or Wildlife Betterment

14,27,38,43,51,53

10

Spring 1981

<u>FISCAL YEAR</u>	<u>COMP'T</u>	<u>STAND</u>	<u>ACRES</u>	<u>DATES</u>
1982	3	3,4,5,6,7,8,9,10	840	NOV. 82 July 1981 Summer 81
		11		June 1982
	22 ★	1,3,4,5,6,8,9,10	698	FEB. 82 (CONTRACT 82)
		12,13,14,15,16,17		
	39	6,7,8,9,10,11,13	887	JAN. 82 Summer 81
		14,15,16		
	40 ★	1,2,3,5,6,8	702	MARCH 82 (CONTRACT 82)
	42 ★	2,3,4,7,8	634	MAY 82 (CONTRACT 82)
	J-2 44 ★	1,2,4,6,8,9,12,13		
		14	1,036	JULY 82 (CONTRACT 82)
<u>Acres to Cut</u>			4,797	
<u>Prescribed Burning</u>				
	1,4,8,9,10,18			
	25,32,52,55,56			
	58,62 and all ranges	7,919	December 1981 March 1982	
<u>Site Preparation</u>				
	19,28,36,41 and other needed cut areas	300	June 1982 October 1982	
<u>Reforestation</u> (Natural & Artificial)				
	19,28,36,41 and other needed cut areas	300	December 1982 March 1983	
<u>Erosion Control and/or Wildlife Betterment</u>				
	3,22,39,40,42,44	9	Spring 1982	

<u>FISCAL YEAR</u>	<u>COMP'T</u>	<u>STAND</u>	<u>ACRES</u>	<u>DATES</u>
1983	★ 2	3,4,5,6,9	506	→ July 1982 <i>CONTRACT 83</i>
	★ 17	1,2,4,5,7,8	802	→ June 1983 <i>CONTRACT 83</i>
	20	1,6,7,8,10,11	883	<i>SUMMER 82</i>
	★ 29	1,2,3,4,5,6,8,9	968	→ <i>CONTRACT 83</i>
		11,12,13,14		
	③ 37	1,2,4,5,6,9,10,11	755	
	★ 47	1,2,3,4,5,6,7,9,10	946	<i>L-S BUFFER CONTRACT 83</i>
		12,13,14		
	<i>FROM F.Y. '79</i> → ⑥ 61			→ <i>SUMMER 82</i>
	<u>Acres to Cut</u>		4,860	
	<u>Prescribed Burning</u>	13,15,19,28,31 33,36,41,45,46 54,60 and all ranges	8,394	December 1982 March 1983
	<u>Site Preparation</u>	38,43 and other necessary cut areas	225	June 1983 October 1983
	<u>Reforestation</u> (Natural & Artificial)	38,43 and other necessary cut areas	225	December 1983 March 1984
	<u>Erosion Control and/or Wildlife Betterment</u>	2,17,20,29,37,47	8	Spring 1983

*QUAK. MANAGEMENT TO F.Y. 78* → ③ 37

*FROM F.Y. '79* → ⑥ 61 → *SUMMER 82*

<u>FISCAL YEAR</u>	<u>COMP'T</u>	<u>STAND</u>	<u>ACRES</u>	<u>DATES</u>
1984	1 ★	1,2,3,4,5,6,8,9 10,11,12	762 →	July 1983 <i>CONTRACT 84</i> June 1984
	4 ★	2,8	100 →	<i>CONTRACT 84</i>
	10 ★	1,2,4,7,8,9,10	593 →	<i>CONTRACT 84</i>
	18	4, 1/2 of 5,7,8 1/3 of 13,14,6	386	<i>Summer 83</i>
	32	3,4,5,6,7,8,9,10	849	<i>Summer 83</i>
	56 ★	1, 1/2 of 2,5,6,9 North 1/2 of 10,12 13,14	→	<i>CONTRACT 84</i>
			<u>443</u>	
	<u>Acres to Cut</u>		3,133	
	<u>Prescribed Burning</u>	6,12,14,27,30 38,43,48,50,51 53,59 and all ranges	7,293	December 1983 March 1984
	<u>Site Preparation</u>	3,39,44 and other necessary cut areas	526	June 1984 October 1984
	<u>Reforestation</u> (Natural & Artificial)	3,39,44 and other necessary cut areas	526	December 1983 March 1984
	<u>Erosion Control and/or Wildlife Betterment</u>	1,4,18,32,56	8	Spring 1984

Projection of site preparation and reforestation for compartments harvested in Fiscal Year 1983 - 1984 respectively. Additional areas cut may be included as necessary.

	<u>COMP'T</u>	<u>ACRES</u>	<u>DATES</u>
<u>Site Preparation</u>	2,17,29,37 and other cut areas as necessary	408	June 1984 October 1984
<u>Reforestation</u> (Natural and Artificial)	2,17,29,37 and other cut areas necessary	408	December 1984 March 1985
<u>Site Preparation</u>	1,18,32,56 and all cut areas necessary	271	June 1985 October 1985
<u>Reforestation</u> (Natural and Artificial)	1,18,32,56 and all cut areas necessary	271	December 1985 March 1986

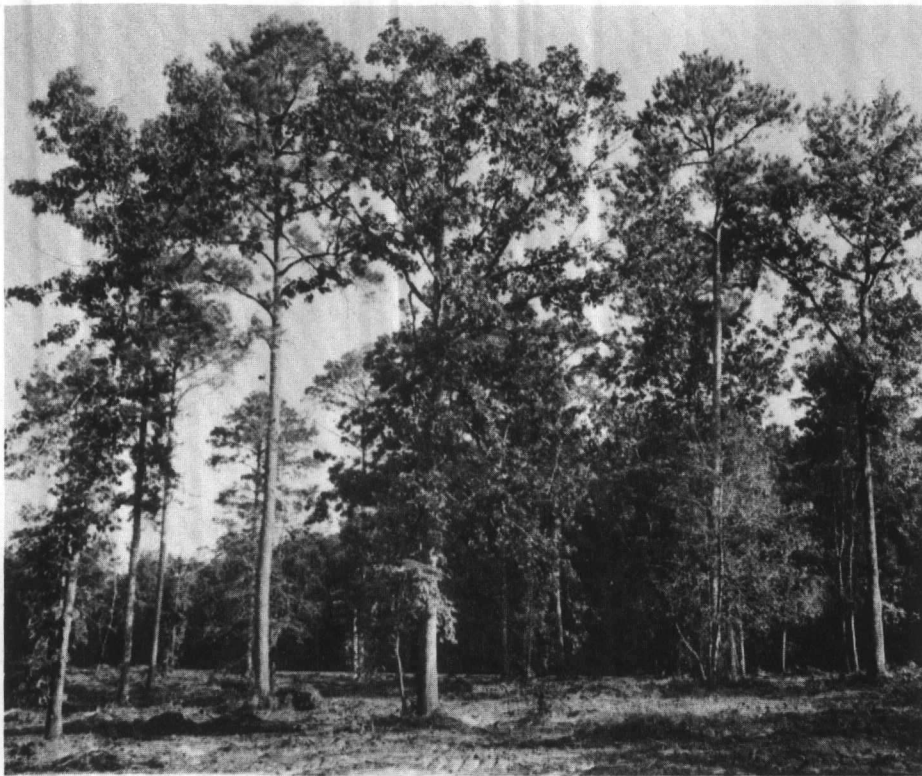

*Site preparation of seed-tree cut areas is necessary for natural regeneration. Hardwood species are left for wildlife food and cover.*

J. STAND PRESCRIPTIONS

No detailed stand prescriptions will be prepared in this plan. Only basic stand data and general stand history are presented. The detailed prescription of stand treatment in each compartment will be prepared by the forester when he enters the respective compartments each Fiscal Year.

STAND PRESCRIPTION  
COMPARTMENT 1

<u>Stand No.</u>	<u>Acres</u>	<u>Type and Size Class</u>	<u>Prescription</u>
1	274	Loblolly Pine Sawtimber	Enter FY-84 for possible regeneration cut in parts of stand. Thinned in FY-75.
2	61	Loblolly Pine Poletimber	Enter FY-84 for more detailed prescription. Young growing stock. Thinned in FY-75.
3	77	Loblolly Pine Poletimber	Enter FY-84 for more detailed prescription. Young growing stock mixed with scattered hardwood. Thinned in FY-75.
4	57	Black Gum Red Maple Sawtimber	Inoperable.
5	52	Loblolly Pine Poletimber	Enter in FY-84 for further detailed prescription. Housing expansion planned in FY-75 on or about 15 acres. Good growing stock. Thinned in FY-75.
6	24	Loblolly Pine Sawtimber	Enter FY-84 for more detailed prescription. Mixed hardwoods in stand. Thinned in FY-75.
7	109	Loblolly-Hardwood Sawtimber	Enter FY-84 for more detailed prescription. East portion seed-treed in FY-75. Good growth; probably thin west portion.
8	24	Loblolly Pine Poletimber	Enter FY-84 for more detailed prescription. Thinned in FY-75.
9	89	Black Gum Red Maple Sawtimber	Enter FY-84 for further prescription. Some portions thinned in FY-75. Some mature pine in stand.
10	44	Sweet Gum Water Oak Sawtimber	Inoperable.
11	18	Loblolly Pine Sawtimber	Enter FY-84 for prescription. Thinning in FY-75. Some hardwoods mixed in stand. Encourage mixed stands on good site.
12	30	Loblolly Pine Poletimber	Enter FY-84 for prescription. Thinning needed. Leave zone along river.

STAND PRESCRIPTION  
 COMPARTMENT 2

<u>Stand No.</u>	<u>Acres</u>	<u>Type and Size Class</u>	<u>Prescription</u>
1	23	Loblolly Pine Seedling-Sapling	Inoperable. Planted in FY-75. <i>LOBLOLLY PINE</i>
2	11	Black Gum Red Maple Sawtimber	Inoperable. Thinned in FY-72 with loblolly pine.
3	292	Loblolly Pine Sawtimber	Enter FY-83 for prescription. Thinned FY-72. Encourage hardwoods on better sites for mixed stands.
4	9	White Oak Red Oak Sawtimber	Enter FY-83 for prescription. Thin only for sanitation and salvage.
5	50	Loblolly-Hardwood Sawtimber	Enter FY-83 for prescription. Thinned in FY-72. Encourage mixed stand.
6	81	Black Gum Red Maple Sawtimber	Enter FY-83 for prescription. Thinned in spots FY-72. Encourage pine to mix in stand where possible.
7	35	Slash Pine Seedling-Sapling	Inoperable. Planted FY-75 with slash pine.
8	116	Loblolly Pine Seedling-Sapling	Inoperable. Seed-tree cut in FY-72 and site prepared in FY-75.
9	74	Loblolly Pine Sawtimber	Enter FY-83 for prescription. Thinned in FY-72. Encourage hardwoods in better sites.
10	10	Loblolly Pine Seedling-Sapling	Inoperable. Planted to loblolly pine in FY-75.

STAND PRESCRIPTION  
 COMPARTMENT 3

<u>Stand No.</u>	<u>Acres</u>	<u>Type and Size Class</u>	<u>Prescription</u>
1	48	Loblolly Pine Sawtimber	Enter FY-82 for prescription. Thinned in FY-71. Encourage hardwoods where site is good.
2	22	Loblolly Pine Seedling-Sapling	Inoperable. Planted with loblolly seedlings in FY-73.
3	39	Loblolly Pine Sawtimber	Enter FY-82 for prescription. Stand in young sawtimber size.
4	162	Loblolly-Hardwood Sawtimber	Enter FY-82 for prescription. Stand thinned in FY-71. Encourage growth of mixed stand - pine hardwoods.
5	403	Loblolly Pine Sawtimber	Enter FY-82 for prescription stand thinned in FY-71. Encourage hardwoods on better sites through stand.
6	36	Loblolly-Hardwood Sawtimber	Enter FY-82 for prescription. Encourage mixture of hardwood-pines when prescribing.
7	64	Pond Pine Poletimber	Enter FY-82 for prescription. Was not treated in FY-71.
8	16	Sweet Gum Water Oak Sawtimber	Enter FY-82 for prescription. Was not treated in FY-71. If prescribed for thinning, do not fill stream or ditch.
9	14	Loblolly Pine Sawtimber	Enter FY-82 for prescription. Was not treated in FY-71. Consider zone around developed areas.
10	65	Loblolly-Hardwood Sawtimber	Enter FY-82 for prescription. Thinned in FY-71. Encourage pine-hardwood mixture.
11	41	Sweet Gum Water Oak Sawtimber	Enter FY-82 for prescription. Not treated in FY-71. Favor mast producing trees if thinned.
12	153	Black Gum Red Maple Poletimber	Inoperable. Not treated in FY-71.
13	35	Loblolly Pine Seedling-Sapling	Inoperable. Planted to slash pine in FY-75.



STAND PRESCRIPTION  
 COMPARTMENT 4

<u>Stand No.</u>	<u>Acres</u>	<u>Type and Size Class</u>	<u>Prescription</u>
1	24	Longleaf Pine Sawtimber	Enter FY-84 for prescription. Partly thinned in FY-75.
2	344	Loblolly Pine Sawtimber	Enter FY-84 for prescription. Two portions of stand between stands 1 and 3 were seed-tree cut in FY-75; other portions thinned.
3	51	White Oak Red Oak Sawtimber	Enter FY-84 for prescription. Thinning treatment in FY-75.
4	7	Loblolly-Hardwood Sawtimber	Inoperable. Stand thinned FY-75.
5	56	Loblolly Pine Sawtimber	Inoperable. Seed-tree cut in FY-75.
6	4	Loblolly-Hardwood Sawtimber	Inoperable. Seed-tree cut in FY-75
7	15	Sweet Gum Water Oak Sawtimber	Inoperable. Maintained for aesthetic value along Golf Course.
8	28	Loblolly Pine Sawtimber	Enter FY-84 for prescription. East portion heavily thinned in FY-73 for aesthetic value for Golf Course.

STAND PRESCRIPTION  
COMPARTMENT 5

<u>Stand No.</u>	<u>Acres</u>	<u>Type and Size Class</u>	<u>Prescription</u>
1	126	Black Gum Red Maple Sawtimber	Enter FY-77 for prescription. Thinned in FY-66. Maintain streamside zone if cut is prescribed.
2	116	Loblolly Pine Seedling-Sapling	Inoperable. Seed-tree cut in FY-66. <i>SEEDTREES REMOVED FY-76</i>
3	36	Black Gum Red Maple Poletimber	Inoperable. No treatment in FY-66.
4	18	Loblolly Pine Seedling-Sapling	Inoperable. Area partially planted with loblolly in FY-74.
5	129	Loblolly Pine Sawtimber	Enter FY-77 for prescription. Area partially thinned in FY-66.
6	19	Pond Pine Poletimber	Enter FY-77 for prescription. Not treated in FY-66.
7	78	Pond Pine Sawtimber	Enter FY-77 for prescription. Most of stand not treated in FY-66.
8	52	Pond Pine Sawtimber	Enter FY-77 for prescription. Not treated in FY-66.
9	193	Loblolly Pine Sawtimber	Enter FY-77 for prescription. Not treated in FY-66.
10	30	Loblolly Pine Poletimber	Enter FY-77 for prescription. Not treated in FY-66.
11	27	Loblolly-Hardwood Sawtimber	Enter FY-77 for prescription. Thinned in FY-66. Encourage mixed pine-hardwood growth where site permits.
12	70	Loblolly Pine Poletimber	Enter FY-77 for prescription. West portion of stand thinned in FY-66.
13	11	Loblolly Pine Seedling-Sapling	Inoperable. <i>SEEDTREES CUT FY-70.</i> <i>SEEDTREES REMOVED FY-76</i>
14	36	Longleaf Pine Sawtimber	Enter FY-77 for prescription. Stand scattered longleaf entering sawtimber size.
15	20	Loblolly Pine Sawtimber	Enter FY-77 for prescription. Stand partially treated in FY-66. Encourage pine-hardwood mixture where site permits.
16	17	Longleaf Pine Sawtimber	Enter FY-77 for prescription. Stand thinned in FY-66.

STAND PRESCRIPTION  
COMPARTMENT 6

<u>Stand No.</u>	<u>Acres</u>	<u>Type and Size Class</u>	<u>Prescription</u>
1	170	Non-Forested	Inoperable. Pocosin area.
2	101	Loblolly Pine Seedling-Sapling	Inoperable. Partially planted to loblolly in FY-74.
3	52	Longleaf Pine Sawtimber	Enter FY-76 for prescription. No treatment in FY-65.
4	50	Longleaf Pine Poletimber	Enter FY-76 for prescription. No treatment in FY-65.
5	26	Pond Pine Sawtimber	Enter FY-76 for prescription. No treatment in FY-65.
6	35	Pond Pine Poletimber	Enter FY-76 for prescription. Thinned in FY-65.
7	132	Longleaf Pine Sawtimber	Enter FY-76 for prescription. Thinned in FY-65.
8	35	Non-Forested	Inoperable. Pocosin area.
9	23	Pond Pine Sawtimber	Enter FY-76 for prescription. No treatment in FY-65.
10	24	Loblolly Pine Sawtimber	Enter FY-76 for prescription. No treatment in FY-65. Encourage hardwood when site index permits.
11	14	Slash Pine Sawtimber	Enter FY-76 for prescription. Thinned in FY-65.
12	10	Loblolly Pine Sawtimber	Enter FY-76 for prescription. No treatment in FY-65.
13	57	Pond Pine Poletimber	Inoperable during this cutting cycle. Bullet damage in south west half of stand.
14	62	Sweet Gum Water Oak Sawtimber	Enter FY-76 for prescription. Thinning in FY-66 was heavy.
15	16	Loblolly Pine Poletimber	Enter FY-76 for prescription. No treatment in FY-65.
16	16	Loblolly Pine Sawtimber	Enter FY-76 for prescription. Thinned in FY-65.
17	34	Black Gum Red Maple Poletimber	Inoperable this cutting cycle.

STAND PRESCRIPTION  
 COMPARTMENT 7

<u>Stand No.</u>	<u>Acres</u>	<u>Type and Size Class</u>	<u>Prescription</u>
1	59	Loblolly Pine Poletimber	Enter FY-78 for prescription. No treatment in FY-67.
2	172	Black Gum Red Maple Sawtimber	Enter FY-78 for prescription. No treatment in FY-67. If cutting is prescribed, maintain streamside zone.
3	43	White Oak Red Oak Sawtimber	Enter FY-78 for prescription. No treatment in FY-67. If cutting prescribed, use sanitation and salvage cut.
4	66	Pond Pine Sawtimber	Enter FY-78 for prescription. No treatment in FY-67. Leave 50 foot roadside if prescribed for cutting.
5	141	Loblolly Pine Sawtimber	Enter FY-78 for prescription. Removal cut in FY-67.
6	42	Loblolly Seedling-Sapling	Inoperable. Seed-tree cut in FY-67. <i>SEEDTREES REMOVED IN FY-76.</i>
7	345	Longleaf Pine Sawtimber	Enter FY-78 for prescription. No treatment in FY-67.
8	140	Loblolly Pine Sawtimber	Enter FY-78 for prescription. No treatment in FY-67.
9	48	Black Gum Red Maple Sawtimber	Enter FY-78 for prescription. No treatment in FY-67.

STAND PRESCRIPTION  
 COMPARTMENT 8

<u>Stand No.</u>	<u>Acres</u>	<u>Type and Size Class</u>	<u>Prescription</u>
1	127	Loblolly Pine Sawtimber	Enter FY-79 for prescription. Thinning in FY-68 to Basal Area Factor - 70.
2	98	Sweet Gum Water Oak Sawtimber	Enter FY-79 for prescription. No treatment in FY-68. If cutting prescribed, maintain streamside zone.
3	335	Loblolly Pine Sawtimber	Enter FY-79 for prescription. Thinned to Basal Area Factor - 70 in FY-68.
4	17	Loblolly Pine Seedling-Sapling	Inoperable. Removal cut in FY-68.
5	66	Loblolly-Hardwood Sawtimber	Enter FY-79 for prescription. Northern portion of stand removal cut FY-68. Encourage mixed pine-hardwood type if site index allows.
6	16	Longleaf Pine Sawtimber	Enter FY-79 for prescription. Stand partially thinned in FY-68.

STAND PRESCRIPTION  
 COMPARTMENT 9

<u>Stand No.</u>	<u>Acres</u>	<u>Type and Size Class</u>	<u>Prescription</u>
1	60	Loblolly Pine Seedling-Sapling	Inoperable. Seed-tree cut in FY-68. <i>Seedtrees Removed F.Y. -76</i>
2	610	Loblolly Pine Sawtimber	Enter FY-79 for prescription. Thinning to Basal Area Factor - 70 made in FY-68.
3	29	Loblolly Pine Seedling-Sapling	Inoperable. Thinned heavily in FY-68; also bay area.
4	28	Black Gum Red Maple Poletimber	Inoperable. Swampy area.
5	16	White Oak Red Oak Sawtimber	Enter FY-79 for prescription. If prescribed, keep in mind area is watershed for pond dams. Sanitation and salvage only.
6	70	Loblolly-Hardwood Sawtimber	Enter FY-79 for prescription. Thinned in FY-68. Encourage mixture of pine-hardwoods if site permits.

STAND PRESCRIPTION  
 COMPARTMENT 10

<u>Stand No.</u>	<u>Acres</u>	<u>Type and Size Class</u>	<u>Prescription</u>
1	94	Loblolly Pine Sawtimber	Enter FY-84 for prescription. No treatment recorded except southern pine beetle salvage. Maintain 200 foot zone along Brewster Blvd. and 200 foot zone along Holcomb Blvd.
2	38	Loblolly Pine Poletimber	Enter FY-84 for prescription. No previous treatment recorded. Area thick with underbrush. Poor site index.
3	21	Loblolly Pine Sawtimber	Inoperable. Seed-tree cut in whole stand in FY-75.
4	110	Loblolly-Hardwood Sawtimber	Inoperable. Seed-tree cut in northern half of stand; ending at ditch west of borrow bit and east to branch and 200 foot roadside zone. Leave bottom half until next cycle.
5	15	Loblolly Pine Seedling-Sapling	Inoperable.
6	52	Loblolly Pine Poletimber	Inoperable. Stand thinned to Basal Area Factor - 70 in FY-75. Encourage hardwood-pine mixture where possible.
7	17	Loblolly-Hardwood Sawtimber	Inoperable. Stand thinned in FY-75. Encourage pine-hardwood mixture where possible.
8	158	Loblolly Pine Sawtimber	Enter FY-84 for prescription. Stand not treated in FY-75. Encourage pine-hardwood mixture where possible.
9	63	Loblolly-Hardwood Sawtimber	Enter FY-84 for prescription. No treatment made in FY-75.
10	113	Loblolly Pine Sawtimber	Enter FY-84 for prescription. No treatment made in FY-75 east and south of stable and pastures. West side of stand prescribed in FY-75 to Basal Area Factor - 70.
11	65	Black Gum Red Maple Poletimber	Inoperable.

STAND PRESCRIPTION  
 COMPARTMENT 11

<u>Stand No.</u>	<u>Acres</u>	<u>Type and Size Class</u>	<u>Prescription</u>
1	91	Loblolly Pine Sawtimber	Enter FY-68 for prescription. Thinning in FY-67. Encourage hardwood mixture when possible. Leave 200 foot zone on Brewster Blvd.
2	151	Loblolly-Hardwood Sawtimber	Enter FY-78 for prescription. Heavy thinning in FY-67. Encourage pine-hardwood mixture when possible. Leave 200 foot zone along Brewster Blvd.
3	544	Loblolly Pine Sawtimber	Enter FY-78 for prescription. Thinning made in FY-67. Encourage pine-hardwood mixture where possible. Leave 50 foot zone along Stone Street and around Camp Lejeune Senior High School Complex.
4	46	Sweet Gum Water Oak Sawtimber	Inoperable.
5	22	Loblolly-Hardwood Poletimber	Inoperable. Heavy cut made in FY-67.
6	45	Loblolly-Hardwood Sawtimber	Enter FY-78 for prescription. No previous treatment recorded. Encourage pine-hardwood mixture.
7	37	Loblolly Pine Sawtimber	Enter FY-78 for prescription. Thinned in FY-67.
8	20	Loblolly Pine Poletimber	Enter FY-78 for prescription. No previous treatment recorded.



STAND PRESCRIPTION  
 COMPARTMENT 12

<u>Stand No.</u>	<u>Acres</u>	<u>Type and Size Class</u>	<u>Prescription</u>
1	23	Loblolly Pine Poletimber	Enter FY-76 for prescription. Thinned to Basal Area Factor - 75 in FY-65.
2	119	Sweet Gum Water Oak Sawtimber	Inoperable.
3	22	Loblolly Pine Poletimber	Enter FY-76 for prescription. Thinned to Basal Area Factor - 75 in FY-65.
4	15	Loblolly Pine Poletimber	Enter FY-76 for prescription. Thinned in FY-65.
5	144	Loblolly-Hardwood Sawtimber	Enter FY-76 for prescription. Thinned in FY-65. Encourage pine-hardwood mixture when possible.
6	28	Loblolly Pine Poletimber	Enter FY-76 for prescription. Thinned to Basal Area Factor - 70 in FY-65.
7	81	Black Gum Red Maple Poletimber	Inoperable.
8	62	Loblolly Pine Sawtimber	Enter FY-76 for prescription. Thinned to Basal Area Factor - 90 in FY-65.
9	89	Sweet Gum Water Oak Sawtimber	Enter FY-76 for prescription. No former treatment recorded.
10	64	Loblolly Pine Sawtimber	Enter FY-76 for prescription. Thinned to Basal Area Factor - 90 in FY-65.
11	29	Loblolly Pine Poletimber	Enter FY-76 for prescription. No former treatment recorded.
12	81	Loblolly Pine Sawtimber	Enter FY-76 for prescription. Thinned to Basal Area Factor - 70 in FY-65.
13	42	Loblolly Pine Sawtimber	Enter FY-76 for prescription. Thinned to Basal Area Factor - 90 in FY-65.

STAND PRESCRIPTION  
COMPARTMENT 13

<u>Stand No.</u>	<u>Acres</u>	<u>Type and Size Class</u>	<u>Prescription</u>
1	221	Black Gum Red Maple Poletimber	Inoperable.
2	63	White Oak Red Oak Sawtimber	Enter FY-75 for prescription. No former treatment recorded.
<del>3</del>	<del>47</del>	<del>Loblolly Pine Poletimber</del> <i>Hardwood Sawtimber</i>	Enter FY-75 for prescription. No former treatment recorded.
4	<del>64</del> 111	Loblolly-Hardwood Sawtimber	Enter FY-75 for prescription. No former treatment recorded.
5	197	Loblolly Pine Sawtimber	Enter FY-75 for prescription. Portion of stand south of Race Track Road thinned to Basal Area Factor - 80 in FY-65. No other treatment recorded.
6	19	Loblolly Pine Sawtimber	Enter FY-75 for prescription. Thinned to Basal Factor - 80 in FY-65.
7	9	Loblolly Pine <del>Poletimber</del> <i>SAWTIMBER</i>	Enter FY-75 for prescription. No former treatment recorded.
8	119	Sweet Gum Water Oak Sawtimber	Enter FY-75 for prescription. No former treatment recorded. If prescribed for cut, maintain streamside zone.
9	88	White Oak Red Oak Sawtimber	Enter FY-75 for prescription. No former treatment recorded. If prescribed to thin, use sanitation salvage cut and maintain streamside zone.
10	21	Loblolly Pine Poletimber	Enter FY-75 for prescription. No former record of treatment. Encourage hardwoods when possible.
11	108	Loblolly Pine Sawtimber	Enter FY-75 for prescription. Thinned in FY-65. Encourage hardwoods when possible.
12	73	Loblolly Pine Seedling-Sapling	Inoperable. Seed-tree cut in FY-65.
13	25	Loblolly Pine Seedling-Sapling	Inoperable. Seed-tree cut in FY-65.

STAND PRESCRIPTION  
COMPARTMENT 14

<u>Stand No.</u>	<u>Acres</u>	<u>Type and Size Class</u>	<u>Prescription</u>
1	80	Black Gum Red Maple Poletimber	Inoperable. Swamp
2	187	Loblolly-Hardwood Sawtimber	Enter FY-81 for prescription. No former treatment recorded. Encourage pine-hardwood mixture when possible.
3	71	Loblolly Pine Seedling-Sapling	Inoperable. Removal cut FY-70.
4	317	Loblolly Pine Sawtimber	Enter FY-81 for prescription. No former treatment recorded.
5	2	Loblolly Pine Seedling-Sapling	Inoperable. Old dump planted in FY-73.
6	29	Loblolly-Hardwood Sawtimber	Enter FY-81 for prescription. No former treatment recorded. Encourage this type of stand when prescribing.
7	82	Loblolly-Hardwood Sawtimber	Enter FY-81 for prescription. No former treatment recorded. Encourage this type of stand when prescribing.
8	113	Sweet Gum Water Oak Sawtimber	Enter FY-81 for prescription. No former treatment recorded.
9	98	Loblolly Pine Sawtimber	Enter FY-81 for prescription. Thinned in FY-70. Encourage hardwoods in stand when possible.
10	59	Loblolly Pine Seedling-Sapling	Inoperable. 42-acre seed-tree cut in FY-70. <i>SEEDTREES REMOVED F.Y.-76</i>
11	14	Black Gum Red Maple Poletimber	Inoperable.
12	106	Loblolly Pine Sawtimber	Enter FY-81 prescription. No former treatment recorded. Encourage hardwoods when possible in stand.
13	22	Loblolly Pine Seedling-Sapling	Inoperable. 34 AC. seedtree cut in FY-70 <i>SEEDTREES REMOVED IN F.Y.-76</i>

STAND PRESCRIPTION  
COMPARTMENT 15

Stand No.	Acres	Type and Size Class	Prescription
1	21	<i>Immature</i> Loblolly-Hardwood Sawtimber	Enter FY-75 for prescription. Encourage this type of stand when prescribing. <i>F.Y. 76 prescription is a pine only thinning.</i>
2	27	Loblolly Pine Sawtimber <i>in Regeneration</i>	Enter FY-75 for prescription. This stand was salvaged from southern pine beetle attack in FY-74. <i>PLANTED F.Y. 75 TO LOBLOLLY PINE</i>
3	<del>419</del> 356	<i>IMMATURE</i> Loblolly Pine Sawtimber	Enter FY-75 for prescription. Approximately 15 acres salvaged from southern pine beetle attack in FY-74. No further treatment recorded. Encourage hardwoods when possible. <i>F.Y. 76 prescribed as a thinning. 150 acres lost to S.P.B. infestation in F.Y. 74 &amp; 75.</i>
4	161	<i>IMMATURE</i> White Oak Red Oak Sawtimber	Enter FY-75 for prescription. No former treatment recorded. If prescribed, cut should be sanitation salvage method.
5	27	<i>IMMATURE</i> Black Gum Red Maple Poletimber	Inoperable.
6	22	<i>IMMATURE</i> Pond Pine Poletimber	Enter FY-75 for prescription. No former treatment recorded. <i>F.Y. 76 prescription for thinning. Approximately 5 acres lost to S.P.B. in F.Y. 74 &amp; 75.</i>
3A	10 app.	LOBLOLLY PINE IN REGENERATION	PLANTED F.Y. 75 TO LOBLOLLY PINE
3B	10 app.	S.P.B. SALVAGE	SALVAGED F.Y. 75.
7	63		S.P.B. SALVAGE. SITE Prep F.Y. 76 PLANTED F.Y. 77

STAND PRESCRIPTION  
COMPARTMENT 16

<u>Stand No.</u>	<u>Acres</u>	<u>Type and Size Class</u>	<u>Prescription</u>
1	18	Black Gum Red Maple Poletimber	Inoperable.
2	<del>213</del> 202	Loblolly Pine Sawtimber	Enter FY-77 for prescription. No former treatment recorded. Encourage hardwoods when possible.
3	35	Loblolly-Hardwood Sawtimber	Enter FY-77 for prescription. No former treatment recorded. Encourage this type of stand when prescribing.
4	83	Loblolly Pine Sawtimber	Enter FY-77 for prescription. Thinned to Basal Area Factor - 90 in FY-66. Encourage hardwoods when possible.
5	118	White Oak Red Oak Sawtimber	Enter FY-77 for prescription. Thinned to Basal Area Factor - 65 in FY-66 in most of this stand.
6	66	Loblolly Pine Sawtimber	Enter FY-77 for prescription. Thinned to Basal Area Factor - 90 in FY-66 and also had southern pine beetle salvage.
7	214	Loblolly Pine Sawtimber	Enter FY-77 for prescription. Most of stand thinned to Basal Area Factor - 90 in FY-66 except for young mature pine in north west corner of stand.
8	45	Loblolly-Hardwood Sawtimber	Enter FY-77 for prescription. Thinned to Basal Area Factor - 90 in FY-66. Encourage this type stand when prescribing.
9	19	Pond Pine Poletimber	Enter FY-77 for prescription. Thinned to Basal Area Factor - 75 in FY-66.
10	11		<i>S.P.B. Salvage. No Site Pref because of location. Reenter FY 77.</i>

STAND PRESCRIPTION  
 COMPARTMENT 17

<u>Stand No.</u>	<u>Acres</u>	<u>Type and Size Class</u>	<u>Prescription</u>
1	106	Loblolly-Hardwood Sawtimber	Enter FY-83 for prescription. Thinned in FY-72. Encourage this type of stand when prescribing.
2	201	Loblolly Pine Sawtimber	Enter FY-83 for prescription. Thinned in FY-72. Encourage hardwoods when possible.
3	90	Black Gum Red Maple Poletimber	Inoperable.
4	185	Loblolly-Hardwood Sawtimber	Enter FY-83 for prescription. Thinned in FY-72. Encourage this type of stand when prescribing.
5	230	Loblolly Pine Sawtimber	Enter FY-83 for prescription. Thinned in FY-72. Encourage hardwood when possible throughout stand.
6	11	Loblolly Pine Seedling-Sapling	Inoperable. Seed-tree cut FY-72. <i>SEEDBED preparation FY-75.</i>
7	37	White Oak Red Oak Sawtimber	Enter FY-83 for prescription. Light thinning of pine in FY-72.
8	43	Loblolly Pine Sawtimber	Entered FY-83 for prescription. Thinned in FY-72. Encourage hardwood mixture when possible when prescribing.
9	25	Black Gum Red Maple Poletimber	Inoperable.

STAND PRESCRIPTION  
COMPARTMENT 18

<u>Stand No.</u>	<u>Acres</u>	<u>Type and Size Class</u>	<u>Prescription</u>
1	27	Sweet Gum Water Oak Poletimber	Enter FY-84 for prescription. Thinned in FY-72 on east side of stand.
2	11	Loblolly Pine Sawtimber	Enter FY-84 for prescription. Thinned in FY-72. Encourage hardwoods when possible.
3	15	Loblolly Pine Poletimber	Enter FY-84 for prescription. Thinned in FY-72. Encourage hardwoods when possible.
4	50	Loblolly Pine Poletimber	Enter FY-84 for prescription. No treatment in FY-72.
5	169	Loblolly Pine Sawtimber	Enter FY-84 for prescription. North half of stand clear-cut in FY-75.
6	12	Loblolly Pine Sawtimber	Enter FY-84 for prescription. Thinned in FY-75. <i>S.P.B. Salvage, Site Prep F.Y. 76 Reanted F.Y. 77</i>
7	106	Sweet Gum Water Oak Sawtimber	Enter FY-84 for prescription. No treatment in FY-75.
8	<del>90</del> <u>35</u>	Loblolly Pine Sawtimber	Enter FY-84 for prescription. Old field area thinned and scattered pine from east boundary to old field stand <del>clear-cut in FY-75.</del>
9	102	Loblolly Pine Poletimber	Enter FY-84 for prescription. Thinned in FY-75 except ahead of F-18 Range. Encourage hardwoods when possible.
10	53	Loblolly Pine Sawtimber	Enter FY-84 for prescription. Removal cut in FY-75. Encourage hardwoods when possible.
11	15	Black Gum Red Maple Poletimber	Inoperable. Bullet damage.
12	43	Black Gum Red Maple Poletimber	Inoperable.
13	38	Loblolly Pine Sawtimber	Enter FY-84 for prescription. North west side of stand clear-cut in FY-75.
14	30	Longleaf Pine Sawtimber	Enter FY-84 for prescription. Thinned in FY-75.
9	57		<i>S.P.B. Salvage, Site Prep F.Y. 76 Reanted F.Y. 77.</i>

Record  
the sale of  
timber in  
this comp't.  
when spec. return

ALSO  
LANDFILL  
&  
Gum St.





STAND PRESCRIPTION  
COMPARTMENT 19

<u>Stand No.</u>	<u>Acres</u>	<u>Type and Size Class</u>	<u>Prescription</u>
1	13	Slash Pine Seedling-Sapling	Inoperable.
2	64	Longleaf Pine Sawtimber	Enter FY-80 for prescription. No former treatment recorded.
3	18	Longleaf Pine Poletimber	Enter FY-80 for prescription. No former treatment recorded.
4	21	Black Gum Red Maple Poletimber	Inoperable.
5	160	Pond Pine Seedling-Sapling	Inoperable.
6	19	Longleaf Pine Poletimber	Enter FY-80 for prescription. No former treatment recorded.
7	39	Loblolly Pine Poletimber	Enter FY-80 for prescription. No former treatment recorded.
8	256	Pond Pine Sawtimber	Enter FY-80 for prescription. Thinned in FY-69.
9	52	Sweet Gum Water Oak Sawtimber	Enter FY-80 for prescription. No former treatment recorded.
10	23	Longleaf Pine Sawtimber	Enter FY-80 for prescription. Thinned in FY-69.
11	23	Loblolly Pine Sawtimber	Enter FY-80 for prescription. Thinned in FY-69.
12	81	Longleaf Pine Poletimber	Enter FY-80 for prescription. Thinned in FY-69.
13	11	Slash Pine Seedling-Sapling	Inoperable. Slash planted in FY-72.
14	6	Black Gum Red Maple Seedlings	Inoperable.
15	<del>49</del> 26	Loblolly Pine Sawtimber	Enter FY-80 for prescription. Thinned in FY-69.
16	74	Loblolly Pine Seedling-Sapling	Inoperable.
17	42	Longleaf Pine Sawtimber	Enter FY-80 for prescription. Thinned in FY-69.
18	11	Black Gum Red Maple Poletimber	Inoperable.
19	64	Loblolly Pine Sawtimber	Enter FY-80 for prescription. No treatment recorded.

20

13

STAND PRESCRIPTION  
COMPARTMENT 20

<u>Stand No.</u>	<u>Acres</u>	<u>Type and Size Class</u>	<u>Prescription</u>
1	220	Sweet Gum Water Oak Sawtimber	Enter FY-83 for prescription. No former treatment recorded. If prescribed, maintain streamside zone.
2	15	Loblolly Pine Seedling-Sapling	Inoperable. Planted in FY-75. <i>LOBLOLLY PINE.</i>
3	16	Loblolly Pine Seedling-Sapling	Inoperable. Planted in FY-75. <i>LOBLOLLY PINE.</i>
4	42	Loblolly Pine Seedling-Sapling	Inoperable. Seed-tree cut in FY-73. <i>SEED TREES REMOVED F.Y. 76.</i>
5	12	Loblolly Pine Seedling-Sapling	Inoperable. Seed-tree cut in FY-73. <i>PLANTED TO LOBLOLLY F.Y. 75.</i>
6	150	Loblolly Pine Poletimber	Enter FY-83 for prescription. Removal cut FY-73 up to stand adjoining food plot on east boundary. Encourage hardwoods when possible.
7	354	Loblolly Pine Sawtimber	Enter FY-83 for prescription. Timber on west and central portions of stand bullet damaged do to firing on F-12 Range. Not treated in FY-73.
8	75	Pond Pine Sawtimber	Enter FY-83 for prescription. Stand prescribed but not treated in FY-73.
9	8	Loblolly Pine Seedling-Sapling	Inoperable. Seed-tree cut in FY-73. <i>SEED TREES REMOVED F.Y. 76.</i>
10	75	Loblolly Pine Poletimber	Enter FY-83 for prescription. No treatment in FY-73.
11	9	Loblolly Pine Poletimber	Enter FY-83 for prescription. No treatment in FY-73.

STAND PRESCRIPTION  
COMPARTMENT 21

<u>Stand No.</u>	<u>Acres</u>	<u>Type and Size Class</u>	<u>Prescription</u>
1	16	Loblolly Pine Poletimber	Enter FY-77 for prescription. No treatment in FY-66. Encourage hardwoods when possible.
2	<i>Retained FY-77 22/19 → 22 → 3A</i>	Loblolly Pine Sawtimber	Enter FY-77 for prescription. No treatment in FY-66. Encourage hardwoods when possible.
3	18	Loblolly Pine Seedling-Sapling	<i>LOBLOLLY PINE IN REGENERATION PLANTED TO LOBLOLLY PINE F.Y.-76. SPB SALVAGE F.Y.-74. TOO SMALL TO MANAGE.</i> Inoperable.
4	139	Longleaf Pine Sawtimber	Enter FY-77 for prescription. No treatment in FY-66. Encourage hardwoods when possible for wildlife.
5	18	Pond Pine Sawtimber	Enter FY-77 for prescription. No treatment in FY-66. Encourage hardwoods when possible.
6	70	Black Gum Red Maple Poletimber	Inoperable.
7	86	Pond Pine Poletimber	Enter FY-77 for prescription. No treatment in FY-66. Encourage hardwoods when possible.
8	26	Loblolly Pine Sawtimber	Enter FY-77 for prescription. Removal cut in FY-66. Encourage cypress and hardwoods when possible.
9	60	Pond Pine Sawtimber	Enter FY-77 for prescription. No treatment in FY-66.
10	<del>153</del> 142	Loblolly Pine Poletimber	Enter FY-77 for prescription. No treatment in FY-66.
10A	110	<i>LOBLOLLY PINE IN REGENERATION</i>	<i>PLANTED F.Y.-76 TO LOBLOLLY PINE. SPB SALVAGE F.Y.-74</i>
11	39	Loblolly Pine Sawtimber	Enter FY-77 for prescription. No treatment in FY-66.
12	14	Non-Forested	Inoperable.

STAND PRESCRIPTION  
COMPARTMENT 22

<u>Stand No.</u>	<u>Acres</u>	<u>Type and Size Class</u>	<u>Prescription</u>
1	90	Loblolly Pine Sawtimber	Enter FY-82 for prescription. No former treatment recorded.
2	26	Slash Pine Seedling-Sapling	Inoperable. Clear-cut FY-71. Planted in FY-73.
3	40	Pond Pine Sawtimber	Enter FY-82 for prescription. Thinning in FY-71.
4	67	Sweet Gum Water Oak Sawtimber	Enter FY-82 for prescription. No former treatment recorded.
5	84	Loblolly Pine Sawtimber	Enter FY-82 for prescription. No former cutting recorded in FY-71. Encourage hardwoods when possible.
6	69	Loblolly Pine Sawtimber	Enter FY-82 for prescription. Thinned in northern half of stand in FY-71. Encourage hardwoods when possible.
7	38	Loblolly Pine Seedling-Sapling	Inoperable. Planted in FY-73.
8	29	Black Gum Red Maple Sawtimber	Enter FY-82 for prescription. Light thinning in FY-71.
9	48	Loblolly Pine Sawtimber	Enter FY-82 for prescription. No treatment recorded in FY-71.
10	31	Longleaf Pine Sawtimber	Enter FY-82 for prescription. Thinned in FY-71.
11	57	Loblolly Pine Seedling-Sapling	Enter FY-82 for prescription. Removal cut in FY-71.
12	57	Loblolly Pine Poletimber	Enter FY-82 for prescription. Thinned in FY-71.
13	45	Pond Pine Poletimber	Enter FY-82 for prescription. No treatment in FY-71.
14	18	Loblolly Pine Sawtimber	Enter FY-82 for prescription. No treatment in FY-71 recorded.
15	48	Pond Pine Sawtimber	Enter FY-82 for prescription. No treatment in FY-71 recorded.
16	28	Loblolly-Hardwood Sawtimber	Enter FY-82 for prescription. No treatment in FY-71 recorded. If prescribed, maintain a mixture of pine-hardwoods.
17	44	Longleaf Pine Sawtimber	Enter FY-82 for prescription. No treatment in FY-71 recorded. Encourage hardwoods if possible for wildlife.

STAND PRESCRIPTION  
COMPARTMENT 23

<u>Stand No.</u>	<u>Acres</u>	<u>Type and Size Class</u>	<u>Prescription</u>
1	29	Loblolly Pine Seedling-Sapling	Inoperable. Removal cut in FY-66.
2	89	Loblolly Pine Sawtimber	Enter FY-77 for prescription. South east part of stand thinned to Basal Area Factor - 75 in FY-66. South west part not prescribed. Encourage hardwoods when possible.
3	68	Loblolly Pine Poletimber	Enter FY-77 for prescription. Removal cut in FY-66.
4	51	Black Gum Red Maple Sawtimber	Enter FY-77 for prescription. No treatment in FY-66 recorded.
5	326	Loblolly Pine Sawtimber	Enter FY-77 for prescription. Area in east of stand thinned in FY-66. No other treatment recorded. Encourage hardwoods when possible.
6	113	Loblolly Pine Poletimber	Enter FY-77 for prescription. East portion of stand thinned in FY-66. No other treatment recorded. Encourage hardwoods when possible.
7	30	Black Gum Red Maple Poletimber	Inoperable.
8	15	Longleaf Pine Sawtimber	Enter FY-77 for prescription. No treatment in FY-66 recorded.
9	94	Pond Pine Poletimber	Enter FY-77 for prescription. No treatment in FY-66 recorded. Encourage hardwoods when possible.
10	53	Longleaf Pine Poletimber	Enter FY-77 for prescription. No treatment in FY-66 recorded. Encourage hardwoods when possible.
11	105	Pond Pine Sawtimber	Enter FY-77 for prescription. East portion thinned in FY-66. No treatment recorded for other part of stand.
12	21	Longleaf Pine Sawtimber	Enter FY-77 for prescription. No treatment recorded in FY-66. Encourage hardwoods when possible.
13	80	Pond Pine Seedling-Sapling	Inoperable.
14	88	Pond Pine Poletimber	Enter FY-77 for prescription. No treatment recorded in FY-66.
15	37	Loblolly Pine Poletimber	Enter FY-77 for prescription. No treatment recorded in FY-66. Encourage hardwoods when possible.
16	27	Black Gum Red Maple Poletimber	Inoperable.
17	29	Loblolly Pine Poletimber	Enter FY-77 for prescription. No treatment recorded in FY-66.

STAND PRESCRIPTION  
 COMPARTMENT 24

<u>Stand No.</u>	<u>Acres</u>	<u>Type and Size Class</u>	<u>Prescription</u>
1	101	Loblolly Pine Sawtimber	Enter FY-78 for prescription. North part thinned in FY-67; south part not prescribed at that time. Encourage hardwoods when possible.
2	23	Black Gum Red Maple Poletimber	Inoperable.
3	30	Sweet Gum Water Oak Sawtimber	Inoperable.
4	327	Loblolly Pine Poletimber	Enter FY-78 for prescription. Removal cut in FY-67.
5	6	Black Gum Red Maple Poletimber	Inoperable.
6	84	Pond Pine Poletimber	Enter FY-78 for prescription. No treatment prescribed in FY-67.
7	49	Longleaf Pine Poletimber	Enter FY-78 for prescription. Removal cut in FY-67.
8	32	Black Gum Red Maple Poletimber	Inoperable.
9	109	Longleaf Pine Poletimber	Enter FY-78 for prescription. Thinned in FY-67.
10	15	Pond Pine Poletimber	Enter FY-78 for prescription. No treatment prescribed in FY-67.
11	15	Cypress-Tupelo Sawtimber	Inoperable.

STAND PRESCRIPTION  
 COMPARTMENT 25

<u>Stand No.</u>	<u>Acres</u>	<u>Type and Size Class</u>	<u>Prescription</u>
1	46	Longleaf Pine Seedling-Sapling	Inoperable. Old range seeding in to longleaf.
2	191	Longleaf Pine Poletimber	Enter FY-79 for prescription. No treatment prescribed in FY-68.
3	45	Loblolly Pine Poletimber	Enter FY-79 for prescription. No treatment prescribed in FY-68. Encourage hardwoods when possible.
4	69	Loblolly-Hardwood Sawtimber	Enter FY-79 for prescription. Heavy cut made in FY-68. Encourage this type of stand when prescribing,
5	30	Loblolly Pine Poletimber	Enter FY-79 for prescription. No treatment prescribed in FY-68. Encourage hardwoods when possible.
6	24	White Oak Red Oak Poletimber	Enter FY-79 for prescription. No treatment prescribed in FY-68.
7	28	Loblolly Pine Poletimber	Enter FY-79 for prescription. Thinning light in FY-68. Encourage hardwoods when possible.
8	409	Loblolly Pine Sawtimber	Enter FY-79 for prescription. Light thinning in FY-68. Encourage hardwoods when possible.
9	12	Loblolly-Hardwood Poletimber	Inoperable. Heavily cut in FY-68.
10	109	Sweet Gum Water Oak Sawtimber	Enter FY-79 for prescription. Heavily cut in FY-68.
11	56	Pond Pine Poletimber	Enter FY-79 for prescription. Light thinning in FY-68.
12	66	Loblolly Pine Seedling-Sapling	Inoperable.
13	36	Pond Pine Poletimber	Enter FY-79 for prescription. No treatment prescribed in FY-68.



STAND PRESCRIPTION  
 COMPARTMENT 26

<u>Stand No.</u>	<u>Acres</u>	<u>Type and Size Class</u>	<u>Prescription</u>
1	108	Loblolly-Hardwood Sawtimber	Enter FY-77 for prescription. Hardwood thinned in FY-66. When prescribing, maintain this type stand.
2	365	Loblolly Pine Sawtimber	Enter FY-77 for prescription. No treatment prescribed in FY-66.
3	16	Pond Pine Seedling-Sapling	Enter FY-77 for prescription. Thinned in FY-66. Area needs regenerating to loblolly pine.
4	78	Loblolly Pine Poletimber	Enter FY-77 for prescription. No treatment other than southern pine beetle salvage. Encourage hardwoods when possible.
5	74	Longleaf Pine Poletimber	Enter FY-77 for prescription. No treatment prescribed in FY-66.
6	48	Pond Pine Poletimber	Enter FY-77 for prescription. No treatment prescribed in FY-66.
7	38	Pond Pine Poletimber	Enter FY-77 for prescription. No treatment prescribed in FY-66.
8	92	Pond Pine Seedling-Sapling	Inoperable.
9	78	Longleaf Pine Sawtimber	Enter FY-77 for prescription. No treatment prescribed in FY-66.
10	64	Loblolly Pine Sawtimber	Enter FY-77 for prescription. Other than southern pine beetle salvage, no treatment prescribed in FY-66. Encourage hardwoods when possible.

STAND PRESCRIPTION  
 COMPARTMENT 27

<u>Stand No.</u>	<u>Acres</u>	<u>Type and Size Class</u>	<u>Prescription</u>
1	368	Loblolly Pine Sawtimber	Enter FY-81 for prescription. Pulp thinning in FY-68.
2	34	Loblolly Pine Seedling-Sapling	Inoperable. Planted to loblolly in FY-73.
3	19	Loblolly Pine Sawtimber	Enter FY-81 for prescription. Thinning in FY-68. Encourage hardwoods when possible.
4	23	Loblolly Pine Sawtimber	Enter FY-81 for prescription. Pulp thinning in FY-68.
5	19	Loblolly Pine Sawtimber	Enter FY-81 for prescription. Pulp thinning in FY-68. Encourage hardwoods when possible.
6	174	Loblolly-Hardwood Sawtimber	Enter FY-81 for prescription. No treatment prescribed in FY-68. Encourage this type of stand when prescribing.
7	149	Longleaf Pine Sawtimber	Enter FY-81 for prescription. Thinning in FY-68 and southern pine beetle salvage.
8	15	Pond Pine Sawtimber	Enter FY-81 for prescription. Thinning in FY-68.
9	33	White Oak Red Oak Sawtimber	Enter FY-81 for prescription. Removal cut of pine in FY-68. If prescribed, encourage pine hardwood mixture.
10	32	Black Gum Red Maple Poletimber	Enter FY-81 for prescription. Removal cut of pine in FY-68.

STAND PRESCRIPTION  
 COMPARTMENT 28

<u>Stand No.</u>	<u>Acres</u>	<u>Type and Size Class</u>	<u>Prescription</u>
1	22	Longleaf Pine Sawtimber	Enter FY-80 for prescription. Thinned in FY-69.
2	13	Loblolly-Hardwood Sawtimber	Enter FY-80 for prescription. No treatment in FY-69. Encourage this type stand when prescribing.
3	15	Loblolly-Hardwood Sawtimber	Enter FY-80 for prescription. No treatment in FY-69. Encourage this type stand when prescribing.
4	41	Loblolly Pine Sawtimber	Enter FY-80 for prescription. Thinned in FY-69. Encourage hardwoods when possible.
5	173	Pond Pine Sawtimber	Enter FY-80 for prescription. Thinned in FY-69.
6	8	Black Gum Red Maple Poletimber	Inoperable.
7	34	Pond Pine Sawtimber	Enter FY-80 for prescription. No treatment in FY-69.
8	31	Pond Pine Seedling-Sapling	Inoperable.
9	13	Loblolly Pine Sawtimber	Enter FY-80 for prescription. No treatment in FY-69. Encourage hardwoods when possible.
10	77	Longleaf Pine Sawtimber	Enter FY-80 for prescription. Southern pine beetle salvage; no treatment in FY-69.
11	243	Pond Pine Sawtimber	Enter FY-80 for prescription. No treatment in FY-69.
12	102	Longleaf Pine Sawtimber	Enter FY-80 for prescription. No treatment in FY-69.
13	110	Longleaf Pine Poletimber	Enter FY-80 for prescription. No treatment in FY-69.
14	25	Pond Pine Sawtimber	Enter FY-80 for prescription. No treatment
15	41	Black Gum Red Maple Poletimber	Inoperable.
16	40	Pond Pine Sawtimber	Enter FY-80 for prescription. No treatment in FY-69.

STAND PRESCRIPTION  
COMPARTMENT 29

<u>Stand No.</u>	<u>Acres</u>	<u>Type and Size Class</u>	<u>Prescription</u>
1	31	Pond Pine Poletimber	Enter FY-83 for prescription. Thinned in FY-73. Encourage hardwoods when possible.
2	121	Pond Pine Seedling-Sapling	Inoperable except to site prepare for planting. Removal cut in FY-73.
3	64	Loblolly-Hardwood Sawtimber	Enter FY-83 for prescription. No treatment in FY-73. Encourage this type of stand.
4	<del>37</del> 17	Longleaf Pine Poletimber	Enter FY-83 for prescription. No treatment in FY-73.
5	30	Loblolly-Hardwood Poletimber	Enter FY-83 for prescription. No treatment in FY-73. Encourage this type of stand.
6	61	Longleaf Pine Poletimber	Enter FY-83 for prescription. Heavy thinning in FY-73. Encourage hardwoods when possible.
7	14	Loblolly Pine Seedling-Sapling	Inoperable.
8	31	Pond Pine Sawtimber	Enter FY-83 for prescription. Treatment in FY-73.
9	71	Longleaf Pine Poletimber	Enter FY-83 for prescription. Treated in FY-73 by heavy cut. Encourage hardwoods where possible.
10	79	Slash Pine Seedling-Sapling	Inoperable. Planted in FY-74.
11	189	Loblolly-Hardwood Sawtimber	Enter FY-83 for prescription. Possibly treated in areas in FY-73. Encourage this type of stand.
12	<del>197</del> <sup>36</sup> 161	Loblolly Pine Sawtimber	Enter FY-83 for prescription. North east part of stand treated in FY-73. Encourage hardwoods when possible.
13	220	Loblolly Pine Sawtimber	Enter FY-83 for prescription. Treatment in FY-73 recorded for all of stand except north west corner. Encourage hardwood timber growth.
14	37	Loblolly Pine Sawtimber	Enter FY-73 for prescription. Treatment in FY-73 recorded. Encourage hardwood timber when possible.
15	20	—————	S.P.B. Salvage. Site Prep FY. '76 Planted F.Y. '77.
16	10	—————	Same
17	26	—————	Same

STAND PRESCRIPTION  
COMPARTMENT 30

<u>Stand No.</u>	<u>Acres</u>	<u>Type and Size Class</u>	<u>Prescription</u>
1	47	Pond Pine Sawtimber	Enter FY-76 for prescription. No treatment prescribed in FY-65.
2	180	Pond Pine Seedling-Sapling	Inoperable. May check for stump wood and regeneration by planting.
3	11	Black Gum Red Maple Poletimber	Inoperable.
4	205	Loblolly-Hardwood Sawtimber	Enter FY-76 for prescription. Thinned in FY-65 for removal of hardwood pulp. Encourage this type stand.
5	319 307	Loblolly Pine Sawtimber	Enter FY-76 for prescription. All stand thinned in FY-65 except for south east portion. Encourage hardwood timber growth.
6	49	Loblolly-Hardwood Sawtimber	Enter FY-76 for prescription. No treatment recorded in FY-65. Encourage this type of stand.
7	26	Loblolly-Hardwood Poletimber	Enter FY-76 for prescription. Thinned in FY-65. Encourage this type stand.
8	58	Loblolly Pine Sawtimber	Enter FY-76 for prescription. Thinned in FY-65. Encourage hardwood timber growth.
9	22	Sweet Gum Water Oak Sawtimber	Enter FY-76 for prescription. Removal of hardwood pulpwood in FY-65.
10	25	Loblolly Pine Sawtimber	Enter FY-76 for prescription. Thinned in FY-65. Encourage hardwood timber growth.
11	36	Loblolly Pine Poletimber	Enter FY-76 for prescription. No treatment in FY-65 recorded. Encourage hardwood growth when possible.
12	18	Black Gum Red Maple Poletimber	Inoperable.
13	32	Pond Pine Poletimber	Enter FY-76 for prescription. No treatment in FY-65 recorded. May be stump wood area.
14	18	Loblolly Pine Poletimber	Enter FY-76 for prescription. No treatment in FY-65 recorded.
15	12		S.P.B. SALVAGED. Site Prep F.Y. 76 PLANTED F.Y. 77

## STAND PRESCRIPTION

COMPARTMENT 31: 70 RE-enter IN F.Y. 80.

Stand No.	Acres	Type and Size Class	Prescription
1	68	<i>Mature Sawtimber</i> Black Gum Red Maple Sawtimber	Enter in FY-75 for prescription. No former treatment recorded. <i>No treatment F.Y. 76. Enter IN F.Y. 80</i>
2	<del>89</del> 185	Loblolly-Hardwood Poletimber <i>SPACE Sawtimber</i>	Enter FY-75 for prescription. No former treatment recorded. <i>ENTERED F.Y. 76. Removal CUTTING prescribed. INCLUDE that portion of stand 3 north of Main Service Rd. in this stand. Approximately 60 ac lost to</i>
3	<del>529</del> 433	Loblolly Pine <i>MATURE</i> Sawtimber	Enter FY-75 for prescription. No treatment recorded except for clearances for Force Troops Complex in late 1960's and FY-74. <i>S.P.B. SALVAGE</i> Encourage hardwood timber.
4	79	Black Gum Red Maple Seedling-Sapling	Inoperable. <i>F.Y. 76 - No treatment.</i>
5	27	Loblolly Pine Poletimber <i>Immature Sawtimber</i>	Enter FY-75 for prescription. No treatment recorded of former treatment. <i>F.Y. 76 prescription is for thinning from below.</i>
6	67	Loblolly Pine Sawtimber <i>Low Quality Poletimber</i>	Enter FY-75 for prescription. No former treatment recorded. Encourage hardwood timber when possible. <i>F.Y. 76 prescription is for Seedtree of PINE only</i>
7	68	<i>MATURE</i> Loblolly-Hardwood Sawtimber	Enter FY-75 for prescription. No former treatment recorded. Encourage this type of stand. <i>F.Y. 76 prescription is for a deferred removal of pine only.</i>
8	62	Loblolly-Hardwood Poletimber <i>Immature Sawtimber</i>	Enter FY-75 for prescription. No former treatment recorded. Encourage this type of stand.
9	11	Loblolly Pine Seedling-Sapling	Inoperable. Planted FY-73. <i>ADEQUATELY STOCKED</i>
10	39	<i>MATURE</i> Loblolly-Hardwood Sawtimber	Enter FY-75 for prescription. No former treatment recorded. Encourage this type stand. <i>F.Y. 76 prescription calls for deferred removal of pine only. This stand has special treatment because of training area in western portion.</i>

STAND PRESCRIPTION  
 COMPARTMENT 32

<u>Stand No.</u>	<u>Acres</u>	<u>Type and Size Class</u>	<u>Prescription</u>
1	52	Loblolly Pine Seedling-Sapling	Enter FY-84 for prescription. No treatment prescribed in FY-73. Encourage hardwoods when possible.
2	15	Sweet Gum Water Oak Sawtimber	Enter FY-84 for prescription. No treatment prescribed in FY-73.
3	64	Pond Pine Sawtimber	Enter FY-84 for prescription. No treatment prescribed in FY-73. This is mostly mature timber. Beware of duds from G-10 Range.
4	206	Longleaf Pine Sawtimber	Enter FY-84 for prescription. No treatment prescribed in FY-73. Some salvage in south end in FY-74 due to fire. Beware of duds from G-10 Range.
5	52	Loblolly Pine Poletimber	Enter FY-84 for prescription. No treatment prescribed in FY-73. Encourage hardwoods when possible.
6	106	Sweet Gum Water Oak Sawtimber	Enter FY-84 for prescription. No treatment prescribed in FY-73.
7	93	Loblolly Pine Sawtimber	Enter FY-84 for prescription. No treatment prescribed in FY-73. Probably removal cut will do. Encourage hardwoods when possible.
8	108	Loblolly Pine Poletimber	Enter FY-84 for prescription. No treatment prescribed in FY-73. Just entering poletimber size. Encourage hardwoods when possible.
9	28	Loblolly Pine Sawtimber	Enter FY-84 for prescription. No treatment prescribed in FY-73. Probably removal cut. Encourage hardwoods when possible.
10	192	Longleaf Pine Poletimber	Enter FY-84 for prescription. No treatment prescribed in FY-73. Beware duds from G-10 Range.

STAND PRESCRIPTION  
 COMPARTMENT

33 : 70 Re-enter in F.Y. 80

Stand No.	Acres	Type and Size Class	Prescription
1 STANDS 1+2 COMBINED	<del>59</del> 97	LOW QUALITY LONGLEAF POLETIMBER <del>Longleaf Pine</del> <del>Sawtimber</del>	Enter FY-75 for prescription. No former treatment recorded. Beware of duds on east and west sides of G-8 and G-9 Ranges. <i>Combined STANDS 1+2. No treatment prescribed F.Y. 75</i>
<del>2</del>	<del>38</del>	<del>Longleaf Pine</del> <del>Poletimber</del>	<del>Enter FY-75 for prescription. No former treatment recorded.</del>
3	26	Longleaf Pine Seedling-Sapling	Inoperable. Beware duds from OP-2 if stand is entered for any reason.
4	37	Pond Pine Poletimber	Inoperable. Beware of duds from G-8 and G-9 Ranges.
5	430	Non-Forested	Inoperable. Beware of duds from OP-2 if entered for any reason.
6	40	Longleaf Pine Seedling-Sapling	Inoperable. Beware of duds from OP-2 if entered for any reason.
7	<del>70</del> 22	LOBLOLLY PINE Longleaf Pine Poletimber Immature Poletimber	Enter FY-75 for prescription. No former treatment prescribed. <i>SHELTERWOOD Prescribed</i>
8	22	SEEDLING-SAPLING ADEQUATELY SACKED Non-Forested POND PINE	Inoperable.
9	38	Longleaf Pine Seedling-Sapling	Inoperable. Beware of duds from G-10 Range if entered for any reason.
10	14	Black Gum Red Maple Sawtimber <i>LOW QUALITY Poletimber</i>	Enter FY-75 for prescription. No former treatment recorded.
11	23	Loblolly Pine Poletimber IMMATURE SAWTIMBER	Enter FY-75 for prescription. No former treatment prescribed. <i>F.Y. 76 prescribed a thinning until crowns were open</i>
12	31	Longleaf Pine Seedling-Sapling IMMATURE SAWTIMBER	Inoperable. <i>SHELTERWOOD Prescribed in F.Y. 76.</i>
13	13	Sweet Gum Water Oak Sawtimber	Inoperable. Beware of duds from G-8 and G-9 Ranges.
7A	48	LONGLEAF IMMATURE SAWTIMBER	<i>Separated from stand 7 in F.Y. 76 prescription because this is ideal nesting habitat for RED-COCKADED WOODPECKER and has been set aside for this purpose.</i>



STAND PRESCRIPTION  
 COMPARTMENT 34

<u>Stand No.</u>	<u>Acres</u>	<u>Type and Size Class</u>	<u>Prescription</u>
1	21	Longleaf Pine Poletimber	Enter FY-78 for prescription. No former treatment recorded.
2	148	Longleaf Pine Seedling-Sapling	Inoperable. Bay-like area.
3	23	Longleaf Pine Poletimber	Enter FY-78 for prescription. No former treatment recorded.
4	78	Longleaf Pine Sawtimber	Enter FY-78 for prescription. No former treatment prescribed in FY-67.
5	27	Loblolly Pine Sawtimber	Enter FY-78 for prescription. No former treatment prescribed in FY-67.
6	68	Loblolly Pine Sawtimber	Enter FY-78 for prescription. Southern part thinned in FY-67 by pulp cut.
7	22	Black Gum Red Maple Sawtimber	Enter FY-78 for prescription. No former treatment prescribed in FY-67.
8	214	Longleaf Pine Sawtimber	Enter FY-78 for prescription. Thinned in FY-67 by pulp cut.
9	13	Loblolly Pine Seedling-Sapling	Inoperable.
10	32	Loblolly Pine Sawtimber	Enter FY-78 for prescription. Thinned in FY-67. Encourage hardwoods when possible.

STAND PRESCRIPTION  
 COMPARTMENT 35

<u>Stand No.</u>	<u>Acres</u>	<u>Type and Size Class</u>	<u>Prescription</u>
1	19	Sweet Gum Water Oak Poletimber	Inoperable.
2	10	Sweet Gum Water Oak Poletimber	Inoperable.
3	45	Non-Forested	Inoperable.
4	93	Loblolly Pine Sawtimber	Enter FY-78 for prescription. Thinned in FY-67 and southern pine beetle salvage in area. Encourage hardwoods when possible.
5	109	Loblolly-Hardwood Sawtimber	Enter FY-78 for prescription. Thinned in FY-67 and southern pine beetle salvage in area. Encourage this type stand.
6	84	Loblolly Pine Sawtimber	Enter FY-78 for prescription. No former treatment in FY-67. Encourage hardwoods when possible.
7	75	Loblolly-Hardwood Sawtimber	Enter FY-78 for prescription. Thinned in FY-67. Encourage this type stand.
8	21	Loblolly-Hardwood Sawtimber	Enter FY-78 for prescription. No former treatment prescribed in FY-67. Encourage this type stand.
9	48	Loblolly-Hardwood Sawtimber	Enter FY-78 for prescription. Thinned in FY-67. Encourage this type stand.
10	159	Loblolly Pine Seedling-Sapling	Inoperable. Northern part thinned in FY-67.
11	55	Loblolly Pine Sawtimber	Enter FY-78 for prescription. No former treatment recorded in FY-67. Encourage hardwoods when possible.
12	57	Longleaf Pine Sawtimber	Enter FY-78 for prescription. No former treatment recorded in FY-67.
13	35	Loblolly Pine Poletimber	Enter FY-78 for prescription. Thinned in FY-67.
14	62	Loblolly Pine Sawtimber	Enter FY-78 for prescription. Thinned in FY-67. Encourage hardwoods when possible.
15	85	Loblolly Pine Poletimber	Enter FY-78 for prescription. Thinned in FY-67.

STAND PRESCRIPTION  
 COMPARTMENT 36

<u>Stand No.</u>	<u>Acres</u>	<u>Type and Size Class</u>	<u>Prescription</u>
1	48	Loblolly Pine Sawtimber	Enter FY-80 for prescription. Thinned in FY-69. Encourage hardwoods when possible.
2	189	Loblolly-Hardwood Poletimber	Enter FY-80 for prescription. No treatment prescribed in FY-69. Encourage this type stand.
3	177	Loblolly Pine Sawtimber	Enter FY-80 for prescription. Thinned in FY-69.
4	62	Loblolly-Hardwood Sawtimber	Enter FY-80 for prescription. No treatment prescribed in FY-69.
5	32	Loblolly Pine Poletimber	Enter FY-80 for prescription. Removal cut in FY-69.
6	89	Loblolly-Hardwood Sawtimber	Enter FY-80 for prescription. No treatment prescribed in FY-69. Encourage this type stand.
7	42	Loblolly Pine Sawtimber	Enter FY-80 for prescription. Thinned in FY-69. Encourage hardwoods species mixture when prescribing.
8	53	Loblolly Pine Sawtimber	Enter FY-80 for prescription. No treatment prescribed in FY-69. Encourage hardwoods in stand when prescribing.
9	109	Loblolly Pine Sawtimber	Enter FY-80 for prescription. West part of stand thinned in FY-69, no treatment in other part.
10	70	Loblolly Pine Seedling-Sapling	Inoperable. Seed-tree cut in FY-69.
11	22	Black Gum Red Maple Sawtimber	Enter FY-80 for prescription. No treatment in FY-69.
12	117	Loblolly Pine Sawtimber	Enter FY-80 for prescription. No treatment in FY-69. Encourage hardwoods when possible.
13	12	Loblolly-Hardwood Sawtimber	Enter FY-80 for prescription. No treatment in FY-69. Encourage this type stand.

STAND PRESCRIPTION  
 COMPARTMENT 37

<u>Stand No.</u>	<u>Acres</u>	<u>Type and Size Class</u>	<u>Prescription</u>
1	45	Loblolly Pine Sawtimber	Enter FY-83 for prescription. No treatment prescribed in FY-72. Encourage hardwoods when possible.
2	20	Sweet Gum Water Oak Sawtimber	Enter FY-83 for prescription. No treatment prescribed in FY-72.
3	33	Loblolly Pine Seedling-Sapling	Inoperable. Seed-tree cut in FY-72. <i>SEEDTREES REMOVED FY-76.</i>
4	22	Loblolly Pine Sawtimber	Enter FY-83 for prescription. Thinned in FY-72. Encourage hardwoods when possible.
5	390- <i>325</i>	Longleaf Pine Sawtimber	Enter FY-83 for prescription. Thinned in FY-72. Encourage oaks when possible for wildlife mast.
6	41	Pond Pine Sawtimber	Enter FY-83 for prescription. No treatment prescribed in FY-72.
7	19	Slash Pine Seedling-Sapling	Inoperable. Planted in FY-73.
8	52	Longleaf Pine Seedling-Sapling	Inoperable. Thinned in FY-72 heavily.
9	57	Longleaf Pine Poletimber	Enter FY-83 for prescription. Thinned in FY-72.
10	86	Pond Pine Sawtimber	Enter FY-83 for prescription. No treatment in FY-72.
11	94	Pond Pine Sawtimber	Enter FY-83 for prescription. No treatment in FY-72.
12	17		<i>SAVAGED AFTER WILDFIRE. SITE Prep F.Y. '76 Planted F.Y. '77</i>

STAND PRESCRIPTION  
 COMPARTMENT 38

<u>Stand No.</u>	<u>Acres</u>	<u>Type and Size Class</u>	<u>Prescription</u>
1	55	Longleaf Pine Poletimber	Enter FY-81 for prescription. No treatment in FY-70.
2	204	Non-Forested	Inoperable.
3	18	Longleaf Pine Seedling-Sapling	Inoperable.
4	42	Loblolly Pine Sawtimber	Enter FY-81 for prescription. No treatment prescribed in FY-72.
5	49	Longleaf Pine Poletimber	Enter FY-81 for prescription. No treatment prescribed in FY-72.
6	70	Longleaf Pine Seedling-Sapling	Inoperable. May prescribe site preparation and plants to slash if prescribed.
7	51	Longleaf Pine Poletimber	Enter FY-81 for prescription. No treatment prescribed in FY-72.
8	167	Longleaf Pine Sawtimber	Enter FY-81 for prescription. No treatment prescribed in FY-72.
9	83	Longleaf Pine Seedling-Sapling	Inoperable. May prescribe for site preparation and plant to slash pine.
10	129	Sweet Gum Water Oak Sawtimber	Enter FY-81 for prescription. No treatment prescribed in FY-72.
11	72	Loblolly Pine Poletimber	Enter FY-81 for prescription. Thinned in FY-72. Encourage hardwoods when possible.
12	22	Loblolly Pine Seedling-Sapling	Inoperable.
13	69	Loblolly Pine Sawtimber	Enter FY-81 for prescription. Thinned in FY-72. Encourage hardwoods when possible.
14	14	Loblolly Pine Poletimber	Enter FY-81 for prescription. No treatment prescribed in FY-72.

STAND PRESCRIPTION  
 COMPARTMENT 39

<u>Stand No.</u>	<u>Acres</u>	<u>Type and Size Class</u>	<u>Prescription</u>
1	<del>6</del> 23 + 11 AC. OF G-10 Impact	<del>SLASH</del> Longleaf Pine Seedling-Sapling	Inoperable. Planted in FY-75 to slash pine after unsuccessful attempt to longleaf in FY-71.
2	56	Pond Pine Poletimber	Enter FY-82 for prescription. No treatment in FY-71.
3	65	Longleaf Pine Seedling-Sapling	Inoperable. Removal cut in FY-71.
4	23	Longleaf Pine Seedling-Sapling	Inoperable. Removal cut in FY-71.
5	33	Black Gum Red Maple Poletimber	Inoperable.
6	63	Pond Pine Sawtimber	Enter FY-82 for prescription. No treatment prescribed in FY-71.
7	51	Longleaf Pine Sawtimber	Enter FY-82 for prescription. Thinned in FY-71.
8	27	Longleaf Pine Poletimber	Enter FY-82 for prescription. Thinned in FY-71.
9	17	Longleaf Pine Poletimber	Enter FY-82 for prescription. Thinned in FY-71.
10	177	Loblolly Pine Sawtimber	Enter FY-82 for prescription. Thinned in FY-71.
11	<del>89</del> 85	Loblolly Pine Poletimber	Enter FY-82 for prescription. North end thinned in FY-71. No other treatment. Encourage hardwoods when possible.
12	32	Slash Pine Seedling-Sapling	Inoperable. Planted in FY-71.
13	62	Loblolly Pine Sawtimber	Enter FY-82 for prescription. No treatment prescribed in FY-71.
14	79	Loblolly-Hardwood Sawtimber	Enter FY-82 for prescription. No treatment prescribed in FY-71. Encourage this type stand.
15	76	Pond Pine Sawtimber	Enter FY-82 for prescription. North east portion of stand thinned in FY-71. Encourage hardwoods when possible.
16	246	Longleaf Pine Sawtimber	Enter FY-82 for prescription. No treatment prescribed in FY-71. Encourage oak species for wildlife mast.
17	220	Loblolly Pine Seedling-Sapling	Inoperable. Fringe area for OP-5 and G-10 Range. Beware of duds.

STAND PRESCRIPTION  
 COMPARTMENT 40

<u>Stand No.</u>	<u>Acres</u>	<u>Type and Size Class</u>	<u>Prescription</u>
1	147	Longleaf Pine Sawtimber	Enter FY-82 for prescription. No treatment in FY-71 prescribed. Encourage oak species for wildlife mast.
2	28	Longleaf Pine Poletimber	Enter FY-82 for prescription. Thinned in FY-71. Encourage oak species for wildlife mast.
3	131	Pond Pine- Hardwood Sawtimber	Enter FY-82 for prescription. No treatment in FY-71 prescribed. Encourage this type of stand.
4	61	Longleaf Pine Seedling-Sapling	Inoperable. Seed-tree cut in FY-71.
5	112	Longleaf Pine Sawtimber	Enter FY-82 for prescription. Removal cut in FY-71.
6	197	Longleaf Pine Poletimber	Enter FY-82 for prescription. Thinned in FY-71.
7	80	Longleaf Pine Seedling-Sapling	Inoperable.
8	87	Longleaf Pine Poletimber	Enter FY-82 for prescription. No treatment prescribed in FY-71.

STAND PRESCRIPTION  
 COMPARTMENT 41

<u>Stand No.</u>	<u>Acres</u>	<u>Type and Size Class</u>	<u>Prescription</u>
1	50	Loblolly-Hardwood Sawtimber	Enter FY-80 for prescription. No treatment prescribed in FY-68. Encourage this type stand.
2	15	Loblolly Pine Poletimber	Enter FY-80 for prescription. No treatment prescribed in FY-68. Encourage hardwoods when possible.
3	213	Loblolly-Hardwood Sawtimber	Enter FY-80 for prescription. No treatment prescribed in FY-68. Encourage this type stand when prescribing.
4	109	Loblolly Pine Sawtimber	Enter FY-80 for prescription. Thinned in FY-68 and salvaged for southern pine beetle attacks. Encourage hardwoods when possible.
5	334 314	Loblolly Pine Sawtimber	Enter FY-80 for prescription. Thinned in FY-68 and salvaged for southern pine beetle attacks. Encourage hardwoods when possible.
6	107	Pond Pine Poletimber	Enter FY-80 for prescription. No treatment prescribed in FY-68.
7	120	Longleaf Pine Sawtimber	Enter FY-80 for prescription. Thinned in FY-68. Encourage oak species for wildlife mast.
8	24	Longleaf Pine Sawtimber	Enter FY-80 for prescription. No treatment prescribed in FY-68. Encourage oak species for wildlife mast.
9	13	Loblolly Pine Seedling-Sapling	Inoperable.
10	20		<i>S.P.B. Salvage. Site Prep F.Y. '76. Planted F.Y. '77</i>



STAND PRESCRIPTION  
COMPARTMENT 42

Stand No.	Acres	Type and Size Class	Prescription
1	99	Loblolly Pine Seedling-Sapling	Inoperable. Seed-tree cut in FY-71. <i>Seedlings Removed FY-76.</i>
2	82	<del>Loblolly Pine</del> <del>Sawtimber</del> <i>LOBLOLLY PINE IN REGENERATION</i>	Enter FY-82 for prescription. No treatment prescribed in FY-71. Encourage hardwoods when possible. <i>S.P.B. SALVAGE FY-74 with natural regeneration FY-76 LOBLOLLY PINE</i>
3	121	Black Gum Red Maple Sawtimber	Enter FY-82 for prescription. No treatment prescribed in FY-71.
4	<del>242</del> 94	Loblolly Pine Sawtimber	Enter FY-82 for prescription. Thinned around stand 5 on south side in FY-71. Encourage hardwoods when possible.
4A	148 AC	<i>LOBLOLLY PINE IN REGENERATION</i> <i>26 ac planted, 102 ac natural with 20 ac left alone for seed source FY-74 SALVAGE CUTTING AND FY-76 REGENERATION</i>	
5	163	Loblolly Pine Seedling-Sapling	Inoperable. Planted to loblolly in FY-73 and 74.
6	37	Loblolly Pine Seedling-Sapling	Inoperable. Seed-tree cut in FY-71.
7	<del>144</del> 75	Loblolly Pine Sawtimber	Enter FY-82 for prescription. Eastern half of stand thinned in FY-71. Encourage hardwoods when possible.
7A	39	<i>LOBLOLLY PINE IN REGENERATION</i>	<i>S.P.B. SALVAGE FY-74 with loblolly planted in FY-76.</i>
8	75	Longleaf Pine Poletimber	Enter FY-82 for prescription. No treatment prescribed in FY-71.

*this must be bedded and replanted FY-77*  
↓  
*replanted FY-78*

STAND PRESCRIPTION  
COMPARTMENT 43

<u>Stand No.</u>	<u>Acres</u>	<u>Type and Size Class</u>	<u>Prescription</u>
1	69	Loblolly Pine Sawtimber	Enter FY-81 for prescription. No treatment prescribed in FY-70. Encourage hardwoods when possible.
2	112	Loblolly Pine Seedling-Sapling	Inoperable. Seed-tree cut in FY-70. <i>SEEDTIES REMOVED F.Y. 76. WILDFIRE 4-14-76</i>
3	13	Loblolly-Hardwood Poletimber	Enter FY-81 for prescription. No treatment prescribed in FY-70. <i>SEEDTIES DAMAGED &amp; will be removed AND the area planted in FY. 77. HOPEFULLY</i>
4	55	White Oak Red Oak Sawtimber	Inoperable.
5	150	Loblolly Pine Poletimber	Enter FY-81 for prescription. No treatment prescribed in FY-70. Encourage hardwoods when possible.
6	<del>262</del> 157	Loblolly Pine Sawtimber	Enter FY-81 for prescription. No treatment prescribed in FY-70 except old field in north part. Encourage hardwoods when possible.
7	14	Non-Forested	Inoperable.
8	<del>56</del> 26	Loblolly-Hardwood Sawtimber	Enter FY-81 for prescription. Most of stand thinned in FY-70. Encourage this type of stand when prescribing.
8A	30	Loblolly Pine in REGENERATION	S.P.B. SALVAGE F.Y. 74 WITH planting to LOBLOLLY PINE F.Y. 76 <i>Check →</i>
6A	54	IN REGENERATION LOBLOLLY PINE	S.P.B. SALVAGE F.Y. 75 TO be planted F.Y. 76 to LOBLOLLY PINE
6B	50	IN REGENERATION HARDWOODS & PINE	S.P.B. SALVAGE F.Y. 75, K.G. 76 but <u>all</u> hardwoods left for natural pine & hardwood regeneration

STAND PRESCRIPTION  
 COMPARTMENT 44

<u>Stand No.</u>	<u>Acres</u>	<u>Type and Size Class</u>	<u>Prescription</u>
1	58	Loblolly Pine Sawtimber	Enter FY-82 for prescription. Thinned in FY-71.
2	<del>359</del> 345 8 <i>LOBLOLLY PINE IN REGENERATION</i>	Loblolly Pine Poletimber	Enter FY-82 for prescription. Thinned in FY-71 and southern pine beetle salvage in FY-68. Encourage hardwoods when possible. <i>S.P.B. SALVAGE F.Y.-74. PLANTED to LOBLOLLY F.Y.-76</i>
3	39	Slash Pine Seedling-Sapling	Inoperable. Planted in FY-73.
4 4A	108 93 15 <i>LOBLOLLY PINE IN REGENERATION</i>	Loblolly Pine Sawtimber	Enter FY-82 for prescription. No treatment in FY-71. Southern pine beetle salvage in FY-68. <i>S.P.B. in F.Y. 75. PLANTED to LOBLOLLY IN F.Y. -76.</i>
5	94	Loblolly Pine Seedling-Sapling	Inoperable. <i>SEEDTREE F.Y.-71. SEEDTRESS REMOVED F.Y.-76.</i>
6	80	Black Gum Red Maple Sawtimber	Enter FY-82 for prescription. Thinned in FY-71.
7	19	Elm-Ash Poletimber	Inoperable.
8	<del>130</del> 124 6 <i>LOBLOLLY PINE IN REGENERATION</i>	Loblolly Pine Sawtimber	Enter FY-82 for prescription. No treatment in FY-71. Encourage hardwoods when possible. <i>S.P.B. SALVAGE F.Y.-75, PLANTED to LOBLOLLY F.Y. 76</i>
9	59	Loblolly-Hardwood Sawtimber	Enter FY-82 for prescription. No treatment in FY-71. Encourage this type of stand.
10	14	Non-Forested	Inoperable.
11	19	Black Gum Red Maple Seedling-Sapling	Inoperable.
12	40	Sweet Gum Water Oak Poletimber	Inoperable.
13	134	Loblolly Pine Sawtimber	Enter FY-82 for prescription. Thinned in FY-71. Encourage hardwoods when possible.
14	74	Loblolly Pine Sawtimber	Enter FY-82 for prescription. Thinned in FY-71. Encourage hardwoods when possible.

STAND PRESCRIPTION  
COMPARTMENT 45

Stand No.	Acres	Type and Size Class	Prescription
1	134	Loblolly Pine Sawtimber	Enter FY-75 for prescription. No previous treatment recorded unless southern pine beetle salvage. Encourage hardwoods when possible. Cut to Basal Area Factor - 70.
2	81	Longleaf Pine Sawtimber	Enter FY-75 for prescription. No previous treatment recorded except southern pine beetle salvage. Encourage oak species for wildlife mast.
3	116	Loblolly-Hardwood Sawtimber	Enter FY-75 for prescription. No previous treatment recorded. Encourage this type stand when prescribing.
4	16	Pond Pine Sawtimber	Enter FY-75 for prescription. No previous treatment recorded.
5	<del>531</del> 351	Loblolly Pine Sawtimber	Enter FY-75 for prescription. No treatment recorded except for southern pine beetle salvage areas. Cut to Basal Area Factor - 70.
6	62	White Oak Red Oak Sawtimber	Enter FY-75 for prescription. No previous treatment recorded. Thin to Basal Area Factor-70.
7	30	Loblolly Pine Sawtimber	Enter FY-75 for prescription. Seed-tree cut except for old range south west of training area. Encourage hardwoods when prescribing.
8	32	Black Gum Red Maple Poletimber	Inoperable.
9	19	White Oak Red Oak Sawtimber	Inoperable. Timber full of shrapnel. Excellent for wildlife.
10	19	Loblolly Pine Sawtimber	Enter FY-75 for prescription. No previous treatment recorded. Thin to Basal Area Factor-70. Encourage hardwoods when possible.
11	10	Scrub Oak Poletimber	Inoperable. Excellent for wildlife.
12	26	Pond Pine Poletimber	Inoperable.
13	23	Sweet Gum Water Oak Sawtimber	Inoperable. Timber full of shrapnel. Excellent for wildlife area.
14	28	<del>Loblolly Pine Sawtimber</del>	Enter FY-75 for prescription. No previous treatment recorded. Cut to Basal Area Factor-70. <i>S.P.B. SALVAGE - NOT SOLD IN KG OF FY 76</i>
15	40	Sweet Gum Water Oak Sawtimber	Inoperable. Timber full of shrapnel. Excellent wildlife area.
16	19	White Oak Red Oak Sawtimber	Inoperable. Timber full of shrapnel. Excellent wildlife area.
17	34	Loblolly Pine Seedling-Sapling	Inoperable. Stand clearcut in FY-74 for southern pine beetle salvage. <i>PLANTED TO LOBLOLLY PINE FY. 75.</i>
18	23		
19	140		219 S.P.B. Salvage. NOT SOLD IN KG CONTRACT OF FY-76
20	17		Same
	18		Same

STAND PRESCRIPTION  
COMPARTMENT 46

<u>Stand No.</u>	<u>Acres</u>	<u>Type and Size Class</u>	<u>Prescription</u>
1	71	Pond Pine Sawtimber	Enter FY-80 for prescription. No treatment prescribed in FY-69.
2	67	Pond Pine Poletimber	Inoperable this cycle.
3	348	Longleaf Pine Sawtimber	Enter FY-80 for prescription. No treatment prescribed in FY-69. Encourage oak species for wildlife mast.
4	30	Pond Pine Poletimber	Enter FY-80 for prescription. No treatment prescribed in FY-69.
5	44	Pond Pine Poletimber	Inoperable this cycle.
6	79	Longleaf Pine Sawtimber	Enter FY-80 for prescription. No treatment recorded in FY-69. Encourage oak species for wildlife mast.
7	56	Loblolly-Hardwood Sawtimber	Enter FY-80 for prescription. No treatment recorded in FY-69. Encourage this type stand when prescribing.
8	23	Black Gum Red Maple Sawtimber	Inoperable.
9	<del>450</del> 451	Loblolly Pine Sawtimber	Enter FY-80 for prescription. No treatment prescribed in FY-69. Encourage hardwoods when possible.
10	67	Pond Pine Sawtimber	Enter FY-80 for prescription. Thinned in FY-69.
11	79	Loblolly-Hardwood Sawtimber	Enter FY-80 for prescription. No treatment prescribed in FY-69. Encourage this type stand when prescribing.
12	10	Loblolly-Hardwood Sawtimber	Enter FY-80 for prescription. No treatment prescribed in FY-69. Consider as head of watershed above seed-tree cut in stand 13 when prescribing.
13	70	Loblolly Pine Seedling-Sapling	Inoperable. Seed-tree cut in FY-69.
14	31	Non-Forested	Inoperable.
15	13	Black Gum Red Maple Sawtimber	Enter FY-75 for prescription. No treatment prescribed in FY-69.

16 19

S.P.B SALVAGE, SITE Prep. F.Y. '76  
PLANTED F.Y. '77

STAND PRESCRIPTION  
COMPARTMENT 47

Stand No.	Acres	Type and Size Class	Prescription
1	<del>266</del> 244 (22)	Longleaf Pine Sawtimber	Enter FY-83 for prescription. No treatment prescribed in FY-73. Encourage oak species for wildlife mast. South east corner bullet damaged from L-5 Range.
2	152	Loblolly-Hardwood Sawtimber	Enter FY-83 for prescription. Thinned in FY-73. Encourage this type stand when prescribing.
3	51	Loblolly Pine Sawtimber	Enter FY-83 for prescription. Thinned in FY-73, partially. Probably has bullet damage from L-5 Range south of stand.
4	53	Pond Pine Sawtimber	Enter FY-83 for prescription. No treatment prescribed in FY-73.
5	41	Longleaf Pine Sawtimber	Enter FY-83 for prescription. Thinned in FY-73. Encourage oak species for wildlife mast.
6	<del>76</del> 71 (13)	<sup>4 LOBLOLLY</sup> Longleaf Pine Sawtimber <i>IN REGENERATION</i>	Inoperable. Heavily thinned in FY-73. <i>DISCED IN F.Y. 75</i>
7	<del>59</del> 27 (32)	Loblolly Pine Poletimber	Inoperable. Heavily thinned in FY-73.
8	49	Pond Pine Poletimber	Inoperable.
9	24	Loblolly Pine Sawtimber	Enter FY-83 for prescription. No treatment prescribed in FY-73. Encourage hardwoods when possible.
10	11	Loblolly Pine Poletimber	Enter FY-83 for prescription. No treatment prescribed in FY-73.
11	27	Slash Pine Seedling-Sapling	Inoperable. Planted in FY-75.
12	17	Loblolly Pine Sawtimber	Enter FY-83 for prescription. No treatment prescribed in FY-73. Encourage hardwoods when possible.
13	<del>33</del> 13A 18	Loblolly Pine Sawtimber <i>LOBLOLLY PINE IN REGENERATION</i>	Enter FY-83 for prescription. Thinned in FY-73. <i>S.P.B. SALVAGE F.Y. 74. Planted loblolly Pine F.Y. 76</i>
14	195 191 (13)	Loblolly-Hardwood Sawtimber	Enter FY-83 for prescription. No treatment prescribed in FY-73. Encourage this type stand when prescribing.

STAND PRESCRIPTION  
COMPARTMENT 48

<u>Stand No.</u>	<u>Acres</u>	<u>Type and Size Class</u>	<u>Prescription</u>
1	169	Loblolly Pine Sawtimber	Enter FY-76 for prescription. Thinned in FY-65 and southern pine beetle salvage in FY-68. Encourage hardwoods when possible.
2	127	Loblolly-Hardwood Sawtimber	Enter FY-76 for prescription. No treatment prescribed in FY-65. Encourage this type of stand when prescribing.
3	142	Loblolly-Hardwood Sawtimber	Enter FY-76 for prescription. Thinned in FY-65. Encourage this type stand when prescribing.
4	19	Black Gum Red Maple Poletimber	Inoperable.
5	16	Loblolly Pine Poletimber	Enter FY-76 for prescription. No treatment in FY-65. Encourage hardwoods when possible.
6	82	Loblolly-Hardwood Sawtimber	Enter FY-76 for prescription. No treatment in FY-65. Encourage this type stand when prescribing.
7	55	Loblolly Pine Sawtimber	Enter FY-76 for prescription. Heavy thinning in FY-65.
8	30	White Oak Red Oak Sawtimber	Enter FY-76 for prescription. Thinned in FY-65.
9	43	Black Gum Red Maple Poletimber	Inoperable
10	10	Loblolly Pine Sawtimber	Enter FY-76 for prescription. Thinned in FY-65. Encourage hardwoods when possible.
11	26	Loblolly-Hardwood Sawtimber	Enter FY-76 for prescription. Thinned in FY-65. Encourage this type stand when prescribing.
12	36	Loblolly Pine Sawtimber	Enter FY-76 for prescription. Thinned in FY-65. Encourage hardwoods when possible.
13	133	Loblolly-Hardwood Sawtimber	Enter FY-76 for prescription. Thinned in FY-65. Encourage this type of stand when prescribing.
14	40	Loblolly Pine Poletimber	Enter FY-76 for prescription. No treatment in FY-65. Encourage hardwoods when possible.
15	19	Loblolly Pine Sawtimber	Enter FY-76 for prescription. Thinned in FY-65. Encourage hardwoods when possible.
16	69	Loblolly-Hardwood Sawtimber	Enter FY-76 for prescription. No treatment in FY-65. Southern pine beetle salvage made. Encourage this type stand.

STAND PRESCRIPTION  
 COMPARTMENT 49

<u>Stand No.</u>	<u>Acres</u>	<u>Type and Size Class</u>	<u>Prescription</u>
1	38	Loblolly Pine Sawtimber	Enter FY-77 for prescription. Thinned in FY-66. Encourage hardwoods when possible.
2	43	Non-Forested	Inoperable.
3	244	Loblolly Pine Sawtimber	Enter FY-77 for prescription. Thinned in FY-66. Encourage hardwoods when possible.
4	70	Loblolly Pine Sawtimber	Enter FY-77 for prescription. Thinned in FY-66. Encourage hardwoods when possible.
5	27	Sweet Gum Water Oak Sawtimber	Enter FY-77 for prescription. No treatment prescribed in FY-66.
6	121	Loblolly Pine Sawtimber	Enter FY-77 for prescription. Thinned in FY-66. Encourage hardwoods when possible.
7	24	Loblolly-Hardwood Sawtimber	Enter FY-77 for prescription. No treatment prescribed in FY-66. Encourage this type stand.
8	170	Loblolly Pine Sawtimber	Enter FY-77 for prescription. No treatment in FY-66. Encourage hardwoods when possible.
9	13	Loblolly-Hardwood Sawtimber	Enter FY-77 for prescription. No treatment in FY-66. Encourage this type stand when prescribing.
10	37	Loblolly-Hardwood Sawtimber	Enter FY-77 for prescription. No treatment prescribed in FY-66. Encourage this type stand when prescribing.
11	38	Loblolly Pine Sawtimber	Enter FY-77 for prescription. No treatment prescribed in FY-66. Encourage hardwoods when possible.
12	13	Black Gum Red Maple Sawtimber	Enter FY-77 for prescription. No treatment prescribed in FY-66.
13	14	White Oak Red Oak Sawtimber	Enter FY-77 for prescription. No treatment prescribed in FY-66.



STAND PRESCRIPTION  
COMPARTMENT 50

<u>Stand No.</u>	<u>Acres</u>	<u>Type and Size Class</u>	<u>Prescription</u>
1 111	<del>110</del> 81 25 <i>3 - LOBLOLLY PINE IN REGENERATION</i>	Loblolly Pine Sawtimber	Enter FY-76 for prescription. No prescribing in FY-65. Encourage hardwoods when possible. <i>S.P.B. SALVAGE F.Y. -75. PLANTED TO LOBLOLLY PINE F.Y. -76</i>
2	18	Sweet Gum Water Oak Poletimber	Inoperable.
3	23	Black Gum Red Maple Sawtimber	Inoperable.
4	<del>114</del> 140 4 <i>LOBLOLLY PINE IN REGENERATION</i>	Loblolly Pine Sawtimber	Enter FY-76 for prescription. No prescribing in FY-65. Encourage hardwoods when possible. <i>S.P.B. SALVAGE F.Y. -75. PLANTED TO LOBLOLLY PINE F.Y. -76</i>
5	19	Loblolly Pine Seedling-Sapling	Inoperable.
6	218	Pond Pine Sawtimber	Enter FY-76 for prescription, when possible. No prescribing in FY-65. Southern pine beetle salvage in FY-68 & 69.
7	67	Black Gum Red Maple Sawtimber	Inoperable.
8	78	Loblolly Pine Poletimber	Enter FY-76 for prescription. No prescribing in FY-65 except planting east of stand when salvaging was done in FY-69.
9	55	Loblolly Pine Seedling-Sapling	Inoperable. Planted in FY-71 & 72.
10	24	Loblolly Pine Seedling-Sapling	Inoperable. Planted in FY-72.
11	12	Loblolly Pine Seedling-Sapling	Inoperable. Planted in FY-71.
12	17	Loblolly Pine Sawtimber	Enter FY-76 for prescription. No prescribing except for salvaging of southern pine beetles and planting in FY-71 & 72.
13	53	Longleaf Pine Sawtimber	Enter FY-76 for prescription. No prescribing in FY-65. Encourage oak species for wildlife mast.
14	25	Loblolly Pine Sawtimber	Enter FY-76 for prescription. No prescribing in FY-65. Encourage hardwoods when possible.
15	22	Loblolly Pine Poletimber	Enter FY-76 for prescription. No prescribing in FY-65. Residual area of southern pine beetle salvage.
16	34	Black Gum Red Maple Sawtimber	Enter FY-76 for prescription. No prescribing in FY-65.
17	59	Pond Pine Poletimber	Enter FY-76 for prescription. No treatment prescribed in FY-65.

STAND PRESCRIPTION  
 COMPARTMENT 51

<u>Stand No.</u>	<u>Acres</u>	<u>Type and Size Class</u>	<u>Prescription</u>
1	22	Slash Pine Seedling-Sapling	Inoperable. Planted in FY-72.
2	104	Pond Pine Sawtimber	Enter FY-81 for prescription. No treatment prescribed in FY-70.
3	10	Longleaf Pine Poletimber	Enter FY-81 for prescription. No treatment prescribed in FY-70.
4	11	Slash Pine Seedling-Sapling	Inoperable. Planted in FY-72.
5	94	Longleaf Pine Poletimber	Enter FY-81 for prescription. Thinned in FY-70. Encourage oak species for wildlife mast.
6	69	Longleaf Pine Sawtimber	Enter FY-81 for prescription. No treatment in FY-70. Encourage oak species for wildlife mast.
7	18	Black Gum Red Maple Poletimber	Inoperable.
8	383	Non-Forested	Inoperable.
9	73	Longleaf Pine Poletimber	Enter FY-81 for prescription. Thinned in FY-70. Encourage oak species for wildlife mast.
10	173	Longleaf Pine Poletimber	Enter FY-81 for prescription. South west side thinned in FY-70. Encourage oak species for wildlife mast.
11	43	Pond Pine Poletimber	Inoperable.
12	29	Non-Forested	Inoperable.

STAND PRESCRIPTION  
 COMPARTMENT 52

<u>Stand No.</u>	<u>Acres</u>	<u>Type and Size Class</u>	<u>Prescription</u>
1	30	Longleaf Pine Sawtimber	Enter FY-79 for prescription. Thinned in FY-70. Encourage oak species for wildlife mast.
2	31	Longleaf Pine Sawtimber	Enter FY-79 for prescription. Thinned in FY-68. Encourage oak species for wildlife mast.
3	25	Longleaf Pine Poletimber	Enter FY-79 for prescription. Removal cut in FY-68. Encourage oak species for wildlife mast.
4	32	Slash Pine Seedling-Sapling	Inoperable. Clearcut in FY-68.
5	265	Pond Pine Seedling-Sapling	Inoperable.
6	73	Longleaf Pine Poletimber	Enter FY-79 for prescription. Thinned in FY-70. Encourage oak species for wildlife mast.
7	158	Longleaf Pine Poletimber	Enter FY-79 for prescription. Thinned in FY-68. Encourage oak species for wildlife mast.
8	45	Loblolly Pine Sawtimber	Enter FY-79 for prescription. South west corner heavily cut in FY-68; remainder of stand thinned in FY-68.
9	23	Loblolly Pine Poletimber	Enter FY-79 for prescription. No treatment prescribed in FY-68.
10	65	Loblolly Pine Sawtimber	Enter FY-79 for prescription. Thinned in FY-68. Encourage hardwoods when possible.
11	19	Pond Pine Poletimber	Enter FY-79 for prescription. Thinned in FY-68.
12	73	Pond Pine Poletimber	Enter FY-79 for prescription. Thinned in FY-68.
13	173	Sweet Gum Water Oak Sawtimber	Inoperable. Pocosin area.

STAND PRESCRIPTION  
 COMPARTMENT 53

<u>Stand No.</u>	<u>Acres</u>	<u>Type and Size Class</u>	<u>Prescription</u>
1	45	Black Gum Red Maple Sawtimber	Enter FY-81 for prescription. Not treated in FY-70.
2	192	Loblolly Pine Sawtimber	Enter FY-81 for prescription. Thinned in FY-70. Encourage hardwoods when possible.
3	120	Loblolly Pine Sawtimber	Enter FY-81 for prescription. Thinned in FY-70. Encourage hardwoods when possible.
4	45	Black Gum Red Maple Sawtimber	Enter FY-81 for prescription. No treatment prescribed in FY-70.
5	120	Longleaf Pine Sawtimber	Enter FY-81 for prescription. Eastern part of stand thinned in FY-70. Encourage oak species for wildlife mast.
6	32	Loblolly Pine Sawtimber	Enter FY-81 for prescription. Thinned in FY-70. Encourage hardwoods when possible.
7	29	Loblolly Pine Seedling-Sapling	Inoperable. Planted in FY-72.
8	85	Loblolly Pine Sawtimber	Enter FY-81 for prescription. Most of stand thinned in FY-70. Encourage hardwoods when possible.
9	145	Loblolly Pine Sawtimber	Enter FY-81 for prescription. Thinned in FY-70. Encourage hardwoods when possible.
10	48	Loblolly Pine Seedling-Sapling	Inoperable.
11	37	Sweet Gum Water Oak Sawtimber	Enter FY-81 for prescription. No treatment prescribed in FY-70.
12	30	Non-Forested	Inoperable.
13	30	Black Gum Red Maple Sawtimber	Enter FY-81 for prescription. No treatment prescribed in FY-70.

STAND PRESCRIPTION  
 COMPARTMENT 54

<u>Stand No.</u>	<u>Acres</u>	<u>Type and Size Class</u>	<u>Prescription</u>
1	153	Longleaf Pine Poletimber	Enter FY-80 for prescription. No treatment prescribed in FY-69. Encourage oak species for wildlife mast.
2	65	Loblolly-Hardwood Sawtimber	Enter FY-80 for prescription. No treatment prescribed in FY-69. Encourage this type stand when prescribing.
3	26	Longleaf Pine Poletimber	Enter FY-80 for prescription. No treatment prescribed in FY-69. Encourage oak species for wildlife mast.
4	29	Loblolly Pine Sawtimber	Enter FY-80 for prescription. No treatment in FY-69 prescribed.
5	90	Non-Forested	Inoperable.
6	253	Pond Pine Seedling-Sapling	Inoperable.
7	188	Longleaf Pine Sawtimber	Enter FY-80 for prescription. No treatment prescribed in FY-69. Encourage oak species for wildlife mast.
8	130	Sweet Gum Water Oak Sawtimber	Enter FY-80 for prescription. No treatment in FY-69 prescribed,
9	25	Loblolly-Hardwood Sawtimber	Enter FY-80 for prescription. Thinned in FY-69.
10	66	Pond Pine Seedling-Sapling	Inoperable. Eastern top half planted in FY-70.
11	63	Slash Pine Seedling-Sapling	Inoperable. Planted in FY-70.
12	8	Slash Pine Seedling-Sapling	Inoperable. Planted in FY-70.
13	36	Slash Pine Seedling-Sapling	Inoperable. Planted in FY-70.
14	72	Loblolly Pine Poletimber	Enter FY-80 for prescription. Thinned in FY-69.
15	33	Loblolly Pine Sawtimber	Enter FY-80 for prescription. Thinned in FY-69. Encourage hardwoods when possible.

STAND PRESCRIPTION  
 COMPARTMENT 55

<u>Stand No.</u>	<u>Acres</u>	<u>Type and Size Class</u>	<u>Prescription</u>
1	91	Loblolly Pine Sawtimber	Enter FY-79 for prescription. Northern part thinned in FY-68. No treatment prescribed to other part of stand.
2	333	Loblolly Pine Sawtimber	Enter FY-79 for prescription. Thinned in FY-68; also southern pine beetle salvage throughout stand. Encourage hardwoods for wildlife mast.
3	13	Non-Forested	Inoperable.
4	111	Sweet Gum Water Oak Sawtimber	Enter FY-79 for prescription. No treatment prescribed in FY-68.
5	35	White Oak Red Oak Sawtimber	Enter FY-79 for prescription. Heavy cut in FY-68.
6	128	Loblolly Pine Sawtimber	Enter FY-79 for prescription. No treatment prescribed in FY-68.
7	16	Loblolly Pine Sawtimber	Enter FY-79 for prescription. No treatment in FY-68 except for southern pine beetle attack salvage. Encourage hardwoods for wildlife when possible.
8	24	Loblolly Pine Sawtimber	Enter FY-79 for prescription. No treatment in FY-68 except for southern pine beetle salvage. Encourage hardwoods for wildlife when possible.
9	9	Slash Pine Seedling-Sapling	Inoperable. Planted in FY-73.

STAND PRESCRIPTION  
COMPARTMENT 56

<u>Stand No.</u>	<u>Acres</u>	<u>Type and Size Class</u>	<u>Prescription</u>
1	48	Loblolly-Hardwood Sawtimber	Enter FY-84 for prescription. No treatment in FY-67 or FY-74. Encourage this type stand when prescribing.
2	134	Loblolly Pine Sawtimber	Enter FY-84 for prescription. North half seed-tree cut in FY-75.
3	53	Non-Forested	Inoperable.
4	73	Loblolly Pine Poletimber	Inoperable. Removal (seed-tree cut) cut in FY-67.
5	32	White Oak Red Oak Sawtimber	Enter FY-84 for prescription. No treatment in FY-67 & 74.
6	65	Loblolly Pine Sawtimber	Enter FY-84 for prescription. Thinned to Basal Area Factor - 70 - FY-74. Encourage hardwoods for wildlife mast.
7	59	Loblolly-Hardwood	Inoperable. Seed-tree cut in FY-75.
8	65	Loblolly-Hardwood Poletimber	Inoperable. Seed-tree cut in FY-67 except for south part which was seed-tree cut along road in FY-75.
9	45	Loblolly Pine Poletimber	Inoperable. Seed-tree or removal cut in FY-67.
10	100	Loblolly-Hardwood Sawtimber	Enter FY-84 for prescription. Western part seed-tree cut or removal cut in FY-67. Southern part of stand inoperable due to shrapnel.
11	24	Loblolly-Hardwood Sawtimber	Enter FY-84 for prescription. Thinned or removal cut in FY-67. Encourage this type stand if prescribed.
12	25	Loblolly Pine Poletimber	Enter FY-84 for prescription. No treatment recorded in FY-67 or 75.
13	<del>25</del> 58	Loblolly Pine Sawtimber	Enter FY-84 for prescription. Thinned to Basal Area Factor - 70 in FY-75 except for seed-tree cut on eastern end of stand.
13A.	37	LOBLOLLY PINE IN REGENERATION	S.P.B. Salvage FY-74. Planted to LOBLOLLY FY-75.
14	26	Sweet Gum Water Oak Sawtimber	Enter FY-84 for prescription. No former treatment recorded.

STAND PRESCRIPTION  
 COMPARTMENT 57

<u>Stand No.</u>	<u>Acres</u>	<u>Type and Size Class</u>	<u>Prescription</u>
1	17	Loblolly-Hardwood Sawtimber	Enter FY-78 for prescription. No treatment in FY-67. Encourage this type stand when prescribing.
2	48	Loblolly Pine Sawtimber	Enter FY-78 for prescription. Thinned in FY-67. Encourage hardwoods when possible for wildlife.
3	28	Loblolly Pine Poletimber	Enter FY-78 for prescription. Thinned in FY-67. Encourage hardwoods when possible for wildlife.
4	125	Loblolly-Hardwood Sawtimber	Enter FY-78 for prescription. No treatment prescribed in FY-67. Encourage this type stand when prescribing.
5	66	Loblolly Pine Sawtimber	Enter FY-78 for prescription. No treatment prescribed in FY-67. Encourage hardwoods for wildlife when prescribing.
6	10	Longleaf Pine Sawtimber	Enter FY-78 for prescription. Thinned in FY-67 possibly.
7	32	Loblolly Pine Poletimber	Enter FY-78 for prescription. Thinned in FY-67 possibly. Encourage hardwoods for wildlife when possible.
8	136	Longleaf Pine Sawtimber	Enter FY-78 for prescription. No treatment recorded in FY-67. Encourage oak species for wildlife mast.
9	90	Loblolly Pine Sawtimber	Enter FY-78 for prescription. No treatment recorded in FY-67. Encourage hardwoods for wildlife when possible.
10	37	Loblolly-Hardwood Sawtimber	Enter FY-78 for prescription. No treatment prescribed in FY-67. Encourage this type stand when prescribing.
11	48	Loblolly Pine Sawtimber	Enter FY-78 for prescription. No treatment recorded in FY-67. Encourage hardwoods for wildlife when possible.



STAND PRESCRIPTION  
COMPARTMENT 58

<u>Stand No.</u>	<u>Acres</u>	<u>Type and Size Class</u>	<u>Prescription</u>
1	17	White Oak Red Oak Sawtimber	Enter FY-79 for prescription. Heavily cut in FY-68.
2 2A.	<del>128</del> 111 17 <i>Longleaf Pine in Regeneration</i>	Loblolly Pine Sawtimber	Enter FY-79 for prescription. Thinned in FY-68. Encourage hardwoods for wildlife when possible. <i>S.P.B. salvage FY-75. Planted to Longleaf Pine FY-76.</i>
3	15	White Oak Red Oak Sawtimber	Enter FY-79 for prescription. Thinned in FY-68.
4	110	Black Gum Red Maple Sawtimber	Enter FY-79 for prescription. No treatment recorded in FY-68.
5	20	Loblolly Pine Seedling-Sapling	Enter FY-79 for prescription. Thinned in FY-68. Encourage hardwoods for wildlife when possible.
6	43	Loblolly-Hardwood Poletimber	Inoperable. Heavily thinned in FY-68.
7	74	Loblolly Pine Seedling-Sapling	Inoperable. Seed-tree cut or removal cut in FY-68.
8	180	Longleaf Pine Sawtimber	Enter FY-79 for prescription. Possible seed-tree cut in middle of stand along access road and thinned at bottom of stand in FY-68.
9 9A.	<del>26</del> 26 10 <i>Longleaf pine in Regeneration</i>	Loblolly Pine Sawtimber	Enter FY-79 for prescription. Thinned in FY-68. Encourage hardwoods for wildlife when possible. <i>S.P.B. salvage FY-75. Planted to Longleaf Pine FY-76</i>
10 10A	<del>124</del> 122 52 <i>Loblolly Pine in Regeneration</i>	Loblolly Pine Sawtimber	Enter FY-79 for prescription. Removal cut in FY-68 in stand except north corner and a thinning there in FY-68. <i>S.P.B. salvage FY-75. Planted to Loblolly Pine FY-76</i>
11	35	Sweet Gum Water Oak Sawtimber	Enter FY-79 for prescription. Thinned in FY-68.
12	41	Loblolly-Hardwood Seedling-Sapling	Inoperable.

STAND PRESCRIPTION  
COMPARTMENT 59

Stand No.	Acres	Type and Size Class	Prescription
1	124	Longleaf Pine Sawtimber	Enter FY-76 for prescription. Thinned in FY-65. Encourage oak species for wildlife mast.
2	46	Loblolly-Hardwood Sawtimber	Enter FY-76 for prescription. No treatment prescribed in FY-65. Encourage this type stand when prescribing.
3	117	Loblolly Pine Sawtimber	Enter FY-76 for prescription. Thinned in FY-65. Encourage hardwoods for wildlife when possible.
4	50	Loblolly-Hardwood Sawtimber	Enter FY-76 for prescription. Pine thinned in FY-65. Encourage this type stand.
5	94	Black Gum Red Maple Sawtimber	Enter FY-76 for prescription. No treatment in FY-65.
6	181 <sup>75</sup>	Pond Pine Sawtimber	Enter FY-76 for prescription. No treatment in FY-65.
6A	27		6A - S.P.E. SALVAGE FY-75 THINNING TO LOBLOLLY PINE FY-76
6B	79		6B - S.P.E. SALVAGE FY-75 EXCLUDED FROM R6 BECAUSE OF
7	216	Loblolly Pine Sawtimber	Enter FY-76 for prescription. Thinned in FY-65. Encourage hardwoods for wildlife when possible. <span style="border: 1px solid black; padding: 2px;">density of hardwoods</span>
8	36	Loblolly Pine Poletimber	Enter FY-76 for prescription. Pulp thinning in FY-65.
9	49	Loblolly-Hardwood Poletimber	Inoperable. Seed-tree cut in FY-65.
10	11	Loblolly Pine Seedling-Sapling	Inoperable. Heavy cut in FY-65.
11	58	Non-Forested	Inoperable.

STAND PRESCRIPTION  
 COMPARTMENT 60

<u>Stand No.</u>	<u>Acres</u>	<u>Type and Size Class</u>	<u>Prescription</u>
1	19	Black Gum Red Maple Sawtimber	Inoperable.
2	227	Loblolly Pine Sawtimber	Enter FY-75 for prescription. No treatment recorded. <i>Entered F.Y. 76 for prescription. Thinning suggested.</i>
3	30	Black Gum Red Maple Poletimber	Inoperable.
4	<del>121</del> 68	Loblolly <sup>HARDWOOD</sup> Pine Sawtimber	Enter FY-75 for prescription. No previous treatment prescribed. Southern pine beetle salvage done in parts. Encourage hardwoods when possible. <i>Entered F.Y. 76 prescribed pine only thinning</i>
5	84	Sweet Gum Water Oak Sawtimber	Enter FY-75 for prescription. No former treatment prescribed.
6	76	Loblolly-Hardwood Sawtimber	Enter FY-75 for prescription. No former treatment prescribed. Encourage this type stand. <i>Entered F.Y. 76 prescribed pine only thinning</i>
7	73	Loblolly Pine Sawtimber	Enter FY-75 for prescription. No former treatment prescribed. Encourage hardwoods when possible. <i>Entered F.Y. 76 prescribed a thinning.</i>
8	<del>35</del> 60	Loblolly Pine Sawtimber	Enter FY-75 for prescription. No former treatment prescribed except salvage of southern pine beetle attacks. Encourage hardwoods. <i>Entered in F.Y. 76. prescribed a thinning</i>
9	24	Loblolly Pine Seedling-Sapling	Inoperable.
10	36	Non-Forested	Inoperable.
11	28	Black Gum Red Maple Sawtimber	Enter FY-75 for prescription. No former treatment prescribed.
12	39	_____	<i>S.P.B salvage F.Y. 75. WAS NOT SOLD IN KG OF 1976.</i>

STAND PRESCRIPTION  
COMPARTMENT 61

<u>Stand No.</u>	<u>Acres</u>	<u>Type and Size Class</u>	<u>Prescription</u>
1	140	Loblolly-Hardwood Sawtimber	Enter FY-76 for prescription. No former treatment recorded. Encourage this type of stand when prescribing.
2	138	Cypress-Tupelo Sawtimber	Enter FY-76 for prescription. No former treatment recorded. Encourage this type particularly cypress growth.
3	88	Loblolly-Hardwood Sawtimber	Enter FY-76 for prescription. No former treatment recorded. Encourage this type of stand when prescribing.
4	32	Non-Forested	Inoperable.
5	27	Loblolly Pine Sawtimber	Enter FY-76 for prescription. No treatment previously recorded.
6	29	Loblolly Pine Sawtimber	Enter FY-76 for prescription. No treatment previously recorded. Encourage hardwoods when possible.
7	12	Loblolly Pine Poletimber	Enter FY-76 for prescription. No treatment previously recorded.
8	10	Loblolly Pine Seedling-Sapling	Inoperable.
9	33	Loblolly-Hardwood Sawtimber	Enter FY-76 for prescription. No previous treatment recorded. Encourage this type stand when prescribing.
10	20	Loblolly Pine Sawtimber	Enter FY-76 for prescription. No previous treatment recorded. Encourage hardwoods when possible.
11	262	Black Gum Red Maple Poletimber	Inoperable.
12	27	Loblolly-Hardwood Poletimber	Inoperable this cycle.
13	89	Loblolly-Hardwood Sawtimber	Enter FY-76 for prescription. No previous treatment recorded. Encourage this type stand.
14	53	Loblolly Pine Sawtimber	Enter FY-76 for prescription. No previous treatment recorded. Encourage hardwoods when possible.
15	77	Loblolly-Hardwood Sawtimber	Inoperable. This timber, although merchantable, is surrounded by swamp. Prescribe in FY-76 if cut is possible.

STAND PRESCRIPTION  
 COMPARTMENT 62

<u>Stand No.</u>	<u>Acres</u>	<u>Type and Size Class</u>	<u>Prescription</u>
1	244	Loblolly-Hardwood Sawtimber	Enter FY-79 for prescription. No previous treatment recorded. Encourage this type stand.
2	41	Loblolly Pine Poletimber	Inoperable.
3	43	Loblolly Pine Sawtimber	Enter FY-79 for prescription. No previous treatment recorded. Encourage hardwoods when possible.
4	77	Loblolly Pine Poletimber	Enter FY-79 for prescription. No previous treatment recorded.
5	38	Slash Pine Seedling-Sapling	Inoperable. Planted in FY-72.
6	48	Slash Pine Seedling-Sapling	Inoperable. Planted in FY-72.
7	29	Scrub Oak Poletimber	Enter FY-79 for prescription. No former treatment recorded. Possible convert to pine-hardwood stand.
8	56	Loblolly Pine Sawtimber	Enter FY-79 for prescription. No former treatment recorded. Encourage hardwoods when possible.
9	24	Scrub Oak Poletimber	Inoperable. Possibly site prepare and plant slash pine with hardwoods.
10	28	Loblolly Pine Sawtimber	Enter FY-79 for prescription. No former treatment recorded. Encourage hardwoods when possible.

# APPENDIX

**APPENDIX**

---



## B. HOW THIS SURVEY WAS MADE

Soil scientists made this survey to determine the kinds of soil, where they are located and how they can be used. They observed steepness, length, and shape of slopes; size and speed of streams; kinds of native plants and many facts about the soils. They dug or bored many holes to expose soil profiles. A profile is the sequence of natural layers, or horizons, in a soil; it extends from the surface down into the parent material that has not been changed much by leaching or by plant roots.

The soil scientists made comparisons among the profiles they studied, and they compared these profiles with those in other areas. They classified and named the soils according to nationwide uniform procedures. The soil series and the soil phase are the categories of soil classification most used in a local survey.

Soils that have profiles almost alike make up a soil series. Except for different texture in the surface layer, all the soils of one series have major horizons that are similar in thickness, arrangement, and other important characteristics. Each soil series is named for a town or other geographic feature near the place where a soil of that series was first observed and mapped. Craven and Pamlico, for example, are the names of two soil series. All the soils in the United States that have the same series name are essentially alike in those characteristics that affect their behavior in the undisturbed landscape.

Soils of one series can differ in texture of the surface layer, in slope, stoniness, or some other characteristic that affects the use of the soils by man. On the basis of such differences, a soil series is divided into phases. The name of a soil phase indicates a feature that affects management. For example, Craven fine sandy loam, 1 to 4 percent slopes, is one of the two phases within the Craven series.

After a guide for classifying and naming the soils had been worked out, the soil scientists drew the boundaries of the individual soils on aerial photographs. These photographs show woodlands, buildings, field borders, trees, and other details that help in drawing boundaries accurately. The soil map was prepared from aerial photographs.

The areas shown on a soil map are called mapping units. On most maps detailed enough to be useful in planning the management of farms and fields, a mapping unit is nearly equivalent to a soil phase. It is not exactly equivalent, because it is not practical to show on such a map all the small, scattered bits of soil of some other kind that have been seen within an area that is dominantly of a recognized soil phase.

Some mapping units are made up of soils of different series, or of different phases within one series. Two such kinds of mapping units are shown on the soil map of Camp Lejeune—soil complexes and undifferentiated groups.

An undifferentiated group is made up of two or more soils that could be delineated individually but are shown as one unit because, for the purpose of the soil survey, there is little value in separating them. The pattern and proportion of soils are not uniform. An area shown on the map may be made up of only one of the dominant soils, or of two or more. The name of an undifferentiated group consists of the names of the dominant soils, joined by "and". Kureb and



Lakeland soils, 0 to 6 percent slopes, is an example.

A soil complex consists of two or more soils so intermingled or so small in size that they cannot be shown separately on the soil map. Each area of a complex contains some of each of the two or more dominant soils, and the pattern and relative proportions are about the same in each area. The name of a soil complex consists of the name of the dominant soils, joined by a hyphen. An example is Corolla-Duckston Complex.

In most areas surveyed there are places where the soil material has been distributed to the extent that it cannot be classified in a soil series. These places are shown on the soil map and are described in the survey, but they are called miscellaneous land types and are given descriptive names. Urban land is a miscellaneous land type.

While a soil survey is in progress, samples of soils are taken, as needed, for laboratory measurements and for engineering tests. Laboratory data from the same kinds of soil in other places are assembled.

But only part of a soil survey is completed when the soils have been named, described, and delineated on the map, and the laboratory data have been assembled. The mass of detailed information then needs to be organized in such a way as to be readily useful to different groups of users. Among them are biologists, foresters, recreation specialists and engineers.

The mapping units used reflect up-to-date knowledge of soils and their behavior under present methods of use and management.

SOIL LEGEND

SYMBOL 1/

NAME

739	Baymeade sand, 1 to 6 percent slopes
853	Bladen fine sandy loam
558B	Craven fine sandy loam, 1 to 4 percent slopes
558C	Craven fine sandy loam, 4 to 8 percent slopes
704	Kureb sand, 0 to 6 percent slopes
582	Leon sand
708	Newhan soils, 2 to 15 percent slopes
365C	Norfolk loamy sand, 6 to 10 percent slopes
415	Onslow fine sandy loam
460	Pactolus loamy sand
870	Torhunta fine sandy loam
6	Urban land
4	Urban land Onslow soils complex, 0 to 6 percent slopes
722	Wando fine sand
833	Woodington loamy sand

The composition of these units is more variable than that of others in the survey area, but has been controlled well enough to be interpreted for the expected use of the soils for woodland and wildlife management.



BA	Baymeade soils, 1 to 6 percent slopes
BJ	Bibb and Johnston soils
BP	Borrow Pit
CA	Capers soils
CD	Corolla - Duckston complex
KL	Kureb and Lakeland soils, 0 to 6 percent slopes
LN	Leon soils
LM	Lynn Haven and Murville soils
ON	Onslow and Norfolk soils, 0 to 6 percent slopes
PM	Pamlico soils
RL	Rains and Lynchburg soils
TP	Torhunta and Pantego soils
WA	Wando and Seabrook soils, 0 to 6 percent slopes

1/ The numerals (or capital letters) refer to the soil name assigned to each unit on the map. A few soils were on sloping areas (558C) and these have a letter to indicate slope class.

D.

LIST OF CONVENTIONAL SYMBOLS USED ON FIELD SHEETS

Roads

-  Divided
-  Good Motor
-  Poor Motor or Private

U. S. 70





or

Route Designation 





Int. 20, U. S. 70, N. C. 58 or 3708 or 3708

Railroads 

Power-Transmission Line 

Natural Gas Mains (Major Pipe Lines) 







Buildings

-  Dwelling
-  Church
-  School
-  Forest Fire Lookout Station
-  Cemetery

Boundaries

 County

Drainage Features (Blue)

-  Large Perennial Streams
-  Small Perennial Streams
-  Intermittent Streams
-  Impounded Pond
-  Dug Ponds
-  Intermittent Lake or Pond

Baymeade Soils, 1 to 6 percent slopes (BA):

These soils are on uplands that are slightly convex divides and on side slopes to drainageways. They are somewhat excessively drained. Baymeade soils make up 75 percent of these delineations. The size of these delineations range from 100 to about 700 acres. These soils are used for woodland. This mapping unit has been designed to provide soils information for the present use of general forestry, wildlife management and recreation. Interpretations for other uses may require soil surveys of more detail.

Typically, the Baymeade soils have surface layers of sand about 24 inches thick. From 0 to 12 inches is dark gray and dark grayish brown, from 12 to 18 inches is olive yellow and has some dark brown coated sand and small brown concretions, and from 18 to 24 inches is olive yellow sand. The subsoil is olive yellow sandy loam from 24 to 35 inches and light yellowish brown loamy sand mottled with strong brown from 35 to about 45 inches. Below this is white and very pale brown sand to about 80 inches.

Included with these soils in mapping are many small areas of Pactolus, and Kureb soils. Together these make up about 25 percent of the mapping unit.

Baymeade soils are slightly to very strongly acid throughout. The available water capacity and organic matter content is low. The permeability is moderately rapid and the shrink-swell potential is low. The surface runoff is slow and the seasonal high water table remains below about 4 feet. The Baymeade soils are coarse textured and consistency is not changed by changing moisture contents. Surface layers are loose or very friable and are sandy.

The most important tree species growing on Baymeade soils are loblolly and longleaf pine. Other tree species are southern red oak, dogwood, holly, red maple, white oak, live oak, black-jack oak, post oak, turkey oak, scarlet oak, persimmon, sassafras, and mockernut hickory. Vegetation is moderately dense. Forest litter is thin, but covers most of the soil surface. The Baymeade soils are poorly suited to management of openland, woodland and wetland wildlife due to somewhat excessive drainage and low available water holding capacity. Included with these soils are small areas of other kinds of soil which can be used for the impoundment of water and are better habitat for openland and woodland wildlife than Baymeade soils. The Baymeade soils have a moderate limitation for camp and picnic areas and a severe limitation for playgrounds and paths and trails because of the sandy texture. Also, in large open areas where vegetation is sparse, soil blowing is a major concern to use and management.

Bibb and Johnston Soils (BJ):

These soils are in narrow floodplains in moderate to deep drainageways and strips along large bodies of water. They are unaffected by brackish tidal overflow. These are level soils that are flooded frequently because of their low elevation and nearness to streams. Most of the acreage is Bibb soils, but Johnston soils make up about 20 percent of most delineations. Johnston soils are in small areas where overflow water is ponded for long periods. These delineations are long and narrow and range from 20 to several hundred acres in size. The soils are used mainly for woodland. This mapping unit has been designed to provide soils information for the present use of general forestry, wildlife management and recreation. Interpretations for other uses may require soil surveys of more detail.

thick. The next layer is grayish brown sandy loam and loamy sand from 6 to about 34 inches. Below this layer is gray and light gray sandy loam, loamy sand, and sand to about 80 inches.

Typically, Johnston soils have surface layers of very dark gray and black loam about 36 inches thick. Below this is gray sandy loam and loamy sand to about 70 inches.

Included in mapping are muck soils and small areas where brackish water overflows due to tidal action. These soils make up less than 15 percent of the mapping unit.

Bibb and Johnston soils are very strongly to strongly acid throughout. The available water capacity is medium to high and organic matter content is moderate to high. The permeability is moderately rapid and the shrink-swell potential is low. These soils are flooded frequently from stream overflow and have a high water table for long periods. These soils are medium and moderately coarse textured and consistency is changed moderately by changing moisture contents.

The most important tree species on these soils are blackgum, sweetgum, cypress, yellow poplar, red maple, carolina ash, holly, sweet bay, loblolly bay, willow oak, water oak, shagbark hickory, pond pine, juniper, black willow, swamp cottonwood, American elm, American sycamore, river birch, American hornbeam, cup oak, and hackberry. Vegetation is dense and includes supplejack and bamboo. These soils are well suited for management of wetland wildlife and woodland wildlife. They have slight to moderate limitations for excavated ponds. The flooding and high water table are severe limitations for recreational uses such as camp and picnic areas, playgrounds and paths and trails.

#### Capers Soils (CA):

These soils are on level tidal flats and are always wet. Elevation is less than 5 feet. They border the sounds and extend up some streams for about 2 miles. These delineations are irregular shaped and range from about 5 to several hundred acres. The soils are unsuited for trees.

Typically, Capers soils have very dark gray silty clay loam about 24 inches thick, contain 0.6 to 2.0 percent sulfur, from .5 to 3 percent fibric plant residue and a content of salt more than 5000 ppm. Below this layer is dark gray and greenish gray silty clay to about 60 inches that also contains salt.

Included in mapping are inaccessable areas that are always completely saturated with sea water and a few small areas of Duckston soils. These included soils make up about 20 percent of the mapping unit.

The Capers soils are neutral to mildly alkaline throughout. The available water capacity is high and the organic matter content is variable. The upper 20 inches contain 0.6 to 2.0 percent sulfur as sulfides. Salt content of the upper 50 inches is more than 5000 ppm. The permeability is slow and shrink-swell potential is high and low bearing capacity. The surface runoff of water is slow and the water table ranges from surface to about 12 inches below the surface. The soils are moderately fine textured and consistency changes greatly with changing moisture content.

The most important plant species growing on these soils are smooth cordgrass, black rush, glass wort, seashore saltgrass and sea-oxeye. The tree cover is less than 10 percent. These soils

are suited for wetland wildlife. They are unsuited for recreation such as camp and picnic areas, playgrounds, paths and trails.

Corolla-Duckston Complex (CD):

These soils comprise the coastal landscapes above the marshes. Slopes are nearly level to concave and usually less than 4 percent. The Corolla soils are moderately well drained and somewhat poorly drained. They are on concave slopes and make up about 60 percent of these delineations. The Duckston soils are on flats and poorly drained and are adjacent to marsh areas. They make up about 25 percent of these delineations. The size of these delineations range from 10 to about 200 acres. This mapping unit has been designed to show areas that have very low potential for woodland. Recreation suitability of the soils are low because of soil instability. However, their proximity to the beaches make them desirable sites for vacation cottages.

Typically, the Corolla soils have grayish brown sand to about 18 inches deep. The next layer is pale brown sand from 18 to about 44 inches. Below this is dark grayish brown, gray and light brownish gray sand to about 70 inches.

Typically, the Duckston soils have grayish brown and dark grayish brown sand to about 18 inches deep. The next layer is gray sand to about 70 inches.

Included in mapping are small areas of Capers and Newhan soils. These soils make up about 15 percent of the mapping unit.

The Corolla and Duckston soils are medium acid through mildly alkaline throughout. The available water capacity and organic matter contents are very low, permeability is very rapid and shrink-swell potential is low. Surface runoff is slow. The Corolla soils have a seasonal high water table at about 18 to 36 inches below the surface. The water table in the Duckston soils fluctuates in relation to the tides. Duckston soils flood following heavy rains or high storm tides. Both soils are coarse textured and consistency is not changed by changing moisture content. Surface layers are loose and sandy.

The important species growing on these soils are wax myrtle, live oak, black willow, black highbush blueberry, bitter panicgrass, hudsonia, coastal lovegrass, evening primrose, ground cherry, bush beardgrass.

Wildlife habitat suitability is poor or very poor. These soils have severe limitations for recreation such as camp and picnic areas, playgrounds and paths and trails due to wetness and loose sandy surface layers.

Kureb and Lakeland Soils, 0 to 6 percent slopes (KL):

These soils are undulating on upland areas between the streams. They are excessively drained. Kureb soils are less hummocky and do not have as deep or narrow sinks between ridges as do Lakeland soils. Kureb soils make up about 60 percent of the delineations, and Lakeland soils about 20 percent. The size of delineations range from about 100 to 700 acres. The soils are used for woodland. This mapping unit has been designed to provide soil information for the present use of general forestry, wildlife management and recreations. Interpretations for other uses may require soil surveys of more detail.

Typically, the Kureb soils have surface layers of gray sand about 8 inches thick. Below this is light gray sand from 8 to 18 inches. The next layer is brown and brownish yellow coated sand, a few lumps or concretions of dark reddish brown, and tongues of light gray sand from 18 to 28 inches. Below this layer is light gray and pale yellow sand to about 85 inches.

Typically, the Lakeland soils have surface layers of gray sand about 6 inches thick. The next layer is pale yellow sand from 6 to about 37 inches, and below this is pale yellow and white sand to about 90 inches.

Included in mapping are small areas of Pactolus, Leon, and Baymeade soils. These soils make up about 20 percent of the mapping unit.

Both Kureb and Lakeland soils are very strongly to medium acid throughout. Available water capacity and organic matter content is very low, permeability is very rapid, and shrink-swell potential is very low. Surface runoff is slow; internal drainage is rapid. The seasonal high water table is below about 50 inches. The soils are coarse textured and consistency is not changed by changing moisture contents. Surface layers are loose and sandy.

The most important tree species growing on these soils are longleaf and loblolly pine, black-jack, post, black, live, white and southern red oaks, persimmon, sassafrass, and mockernut hickory. Vegetation is very sparse and only a very small amount forest litter is on the surface of Kureb and Lakeland soils. These soils require intensive management to produce native vegetation for wildlife. Their habitat potential for openland and woodland wildlife is very poor. Because of the loose sandy texture and soil blowing, these soils have severe limitations for recreation such as camp and picnic areas, playgrounds, and paths and trails.

#### Leon Soils (LN):

These soils are on broad, smooth uplands between the streams. Slopes range from 0 to about 2 percent. The soils are poorly to somewhat poorly drained. The size of these delineations range from about 50 to 2500 acres. These soils are used for woodland. This mapping unit has been designed to provide soils information for the present use of general forestry. Interpretations for other uses may require soil surveys of more detail.

Typically, the Leon soils have surface layers of dark gray sand about 3 inches thick and below this is light gray sand from 3 to about 20 inches. The subsoil is dark reddish brown and black sand weakly cemented by humus coatings and bridging of grains. The next layer is light brownish gray sand to about 70 inches.

Included in mapping are many small areas of Lynn Haven, Murville and Kureb soils. These soils make up about 15 percent of the mapping unit.

The Leon soils are extremely to strongly acid throughout. They have a low content of organic matter. Available water capacity is low, permeability is moderate in subsoil, and shrink-swell potential is low. Surface runoff is slow and the seasonal high water table is from 10 to 30 inches below the surface for more than 9 months, and recedes to about 40 inches in dry seasons. These soils are coarse textured and consistency does not change with changing moisture contents. Surface layers are loose and sandy.

The most important tree species growing in these delineations are pond, longleaf, and loblolly pine, post, blackjack, black, live, white, southern red, water, and willow oaks, loblolly bay, sweet bay, sassafrass, and mockernut hickory. Vegetation is very sparse in most places and forest litter is thin and sparse and is intermingled with patches of wire grass. These soils are poorly suited for wildlife but have only moderate limitations for excavated ponds. These soils have severe limitations for camp and picnic areas, playgrounds, paths and trails due to wetness and sand texture.

Lynn Haven and Murville Soils (IM):

These soils are in slight depressions on broad, smooth uplands between streams. Slopes are less than 1 percent. The soils are very poorly drained. The size of these delineations ranges from 100 to about 300 acres. The Lynn Haven soil may make up about 60 percent. Murville soil may make up about 20 percent of any of these delineations. These soils are used for woodland. This mapping unit has been designed to provide soils information for the present use of general forestry, wildlife management and recreation. Interpretations for other uses may require soil surveys of more detail.

Typically, the Lynn Haven soils have surface layers of black sand about 8 inches thick. Below this is gray sand to about 12 inches. The subsoil is weakly cemented black sand that is coated with humus from 12 to about 20 inches. Below this and to about 65 inches is light gray sand with a few thin layers of weakly cemented humus coated sand.

Typically, the Murville soils have surface layers of black fine sand about 8 inches thick. Below this from 8 to 45 inches is very dark gray fine sand and below 45 to about 66 inches is dark gray fine sand.

Included with these soils in mapping are many small areas of Leon, Torhunta, and Pamlico muck soils. These soils make up about 20 percent of the mapping unit.

The Lynn Haven and Murville soils are very strongly acid throughout. The organic matter content is medium, available water capacity is low, permeability is moderate, and shrink-swell potential is low. The runoff is ponded and seasonal high water table is at 0 to 10 inches for 2 to 6 months. The Lynn Haven and Murville soils are coarse textured and consistency is not changed by changes in moisture content. The surface layers range from loose sand to friable in places where the organic matter content is high.

The most important tree species growing on these soils are pond and loblolly pines, sweetgum, blackgum, loblolly and sweet bays, red maple, yellow poplar, holly, water oak, willow oak, swamp chestnut oak, overcup oak, and Carolina ash. Tree stands are moderately dense but vegetation of shrubs and vines is dense. Thick litter covers the soil surface and sphagnum moss covers many small areas. The soils are suited to wetland and openland wildlife and have only slight limitations for excavated ponds. The soils have severe limitations for recreational uses such as camp and picnic areas, playgrounds, paths and trails because of the wetness and sandy texture.



#### Onslow-Norfolk Soils, 0 to 6 percent slopes (ON):

These upland soils are on broad, smooth interstream divides, convex divides, and side slopes to drainageways. The somewhat poorly to moderately well drained Onslow soils are on most of the nearly level areas and make up about 70 percent of these delineations. The well drained Norfolk soils are on most of the short sloping areas near the drainageways and make up about 20 percent of these delineations. The size of these delineations range from 50 to 500 acres. The soils are used for woodland. This mapping unit has been designed to provide soils information for the present use of general forestry, wildlife management and recreation. Interpretations for other uses may require soil surveys of more detail.

Typically, the Onslow soils have surface layers of loamy fine sand. From 0 to 8 inches it is dark gray, from 8 to 18 inches is light olive brown, and light yellowish brown with many dark yellowish brown and dark reddish brown concretions in the 8 to 15 inch part. The subsoil is chiefly sandy clay loam from 18 to 75 inches, light olive brown mottled with gray and brownish yellow from 18 to 35 inches, and below this is gray mottled with brownish yellow, yellowish brown, and strong brown to about 75 inches.

Typically, the Norfolk soils have surface layers of gray and light yellowish brown loamy fine sand about 14 inches thick. The subsoil is chiefly sandy clay loam from 14 to about 85 inches. From 14 to 36 inches is strong brown and below this is light olive brown mottled with light brownish gray, pale brown, and yellowish red.

Included in mapping are small areas of Baymeade, Lynchburg and Craven soils. Together, these make up about 10 percent of the mapping unit.

The Onslow and Norfolk soils are strongly to very strongly acid throughout. Available water capacity is medium, permeability is moderate, and shrink-swell potential is low. Surface runoff is slow from the Onslow and medium to rapid from the Norfolk soils. The seasonal high water table ranges from 1.5 to 2.5 feet below the surface in the Onslow soils and remains below about 6 feet in the Norfolk soils. These soils are loamy textured and consistency changes moderately with changing moisture contents.

The most important tree species growing on these soils is loblolly pine. Other tree species are longleaf pine, southern red oak, dogwood, holly, red maple, sweetgum, sourwood, blackgum white oak, blackjack oak, post oak, persimmon, hickory and water oak. Vegetation is commonly dense. Forest litter covers most of the soil surface and ranges from 1 to 3 inches thick. These soils have good potential for management of openland and woodland wildlife. The Onslow soils have moderate limitations for recreation because of wetness. Slope is the only limitation to use and management. The limitation ranges from slight for paths and trails to severe for playgrounds and camping areas.

#### Pamlico Soils (PM):

These soils are in depressions on broad, smooth interstream areas. Slopes are level or nearly level. The soils are very poorly drained. The size of these delineations ranges from 25 to about 200 acres. The soils of these delineations are used for woodland. The mapping unit has been designed to provide soils information for the present use of general forestry, wildlife

management and recreation. Interpretations for other uses may require soil surveys of more detail.

Typically, the Pamlico soils have black and very dark brown muck surface layers about 30 inches thick. The muck has a low fiber content after rubbings. Below this is a very dark grayish brown loamy sand to about 60 inches.

Included in mapping are many small areas of Murville, Lynn Haven, Torhunta and Leon soils. These soils make up about 15 percent of the mapping unit.

The Pamlico soils are extremely to very strongly acid. Available water capacity is high, permeability is moderate, surface runoff is ponded, and shrink-swell potential is low in the mineral soil below the muck and the subsistence potential is high in the muck surface layer. The water table is at or near the surface for 6 to 12 months.

The most important tree species growing on these soils are red maple, yellow poplar, blackgum, pond pine, Carolina ash, loblolly and sweet bays, holly, and juniper. The density of the trees is variable. Shrub vegetation is dense. The litter is thick and some of the area is covered with sphagnum moss. These soils are good for wetland wildlife and have only slight limitations for excavated ponds. Where drained, they are a good potential habitat for openland and woodland wildlife. The soils have severe limitations for recreation because of ponding water and a high water table.

#### Rains and Lynchburg Soils (RL):

These soils are on nearly level uplands between the streams. Slopes range from 0 to about 1 percent. The poorly drained Rains soils are on interstream areas and make up about 45 percent of these delineations. The somewhat poorly drained Lynchburg soils are on areas around the heads of drainageways making up about 30 percent of any of these delineations. The size of these delineations ranged from 100 to 1000 acres. The soils are used for woodland. This mapping unit has been designed to provide soils information for the present use of general forestry, wildlife and recreation. Interpretation for other uses may require soil surveys of more detail.

Typically, the Rains soils have surface layers of black sandy loam about 6 inches thick. The next layer is grayish brown sandy loam from 6 to about 15 inches. The subsoil is light brownish gray and gray sandy clay loam mottled with olive brown and olive yellow from 15 to about 80 inches.

Typically, the Lynchburg soils have surface layers of dark grayish brown sandy loam about 5 inches thick. The next layer is light brownish gray sandy loam from 5 to about 15 inches. The subsoil is light olive brown and light yellowish brown sandy clay loam mottled with gray and yellowish brown from 15 to about 28 inches. The next layer is light brownish gray sandy clay loam and sandy loam mottled with brown from 28 to about 80 inches.

Included in mapping are some areas of Woodington, Bladen, Pactolus, and Onslow soils. These soils make up about 25 percent of the mapping unit. The Rains and Lynchburg soils are very strongly to strongly acid throughout. Available water capacity is medium, permeability is moderate, surface runoff is slow, and shrink-swell potential is low. The seasonal high water

table is less than 1 foot for 30 to 90 days during winter and spring. The soils are loamy textured and consistency changes moderately with changing moisture content.

The most important tree species growing on these soils are loblolly, slash, and pond pines, water oak, southern red oak and live oak, sweetgum, dogwood, red maple, holly, sourwood, long-leaf pine, loblolly bay, yellow poplar, sweet bay, shagbark hickory, river birch, and honey locust. Vegetation is commonly dense. Thick forest litter covers the soil surface. These soils respond well when managed for openland and woodland wildlife. They have moderate limitations for ponds; aquifers are 4 to 6 feet. These soils range from good to fair for openland and woodland wildlife. Artificial drainage of the Rains soil would improve the habitat for openland and woodland wildlife. The seasonal high water table and ponding cause moderate to severe limitations for recreation such as camping, picnics, playgrounds, and paths and trails.

#### Torhunta and Pantego Soils (TP):

These soils are in slight depressions on broad, smooth uplands between the streams. Slopes are less than 1 percent. The soils are very poorly drained. Torhunta soils may make up 50 percent or Pantego soils may make up 30 percent of any of the delineations. The size of these delineations ranges from 25 to 300 acres. The soils are used for woodland. This mapping unit is designed to provide soils information for the present use of general forestry, wildlife management and recreation. Interpretations for other uses may require soil surveys of more detail.

Typically, the Torhunta soils have surface layers of black and very dark gray fine sandy loam about 16 inches thick. The subsoil is gray sandy loam from 16 to about 45 inches, and gray and light gray loamy sand from 45 to about 80 inches.

Typically, the Pantego soils have surface layers of black or very dark gray loam about 13 inches thick. The subsoil is gray or grayish brown sandy clay loam from 13 to about 58 inches, and gray or light gray sandy clay loam or sandy loam from 58 to about 80 inches.

Included in mapping are small areas of Murville, Rains and Woodington soils. These soils make up about 20 percent of the mapping unit.

The Torhunta and Pantego soils are strongly to extremely acid throughout. The organic matter content is medium, available water capacity is medium, permeability is moderate, and shrink-swell potential is low. The runoff is ponded and the seasonal high water table is at the surface during winter months. The soils are loamy textured and consistency changes moderately with changing moisture content.

The most important tree species growing on these soils are loblolly and pond pine, sweetgum, blackgum, red maple, yellow poplar, holly, loblolly and sweet bay, water and willow oak, Carolina ash, swamp chestnut, and overcup oaks. Vegetation is very dense. Very thick forest litter covers the soil surface. These soils are a fair habitat for wetland wildlife and poor habitat for openland and woodland wildlife. Where drained, these soils are good habitat for woodland and openland wildlife and poor for wetland wildlife. These soils have only slight limitations for excavated ponds. The wetness and surface ponding is a severe limitation for most recreation uses.

Wando and Seabrook Soils, 0 to 6 percent slopes (WA):

These soils have smooth uplands. The surfaces slope gradually from 25 feet elevation down to about 2 feet elevation or the water line of the high tides. The excessively drained Wando soils are on the higher elevations and slopes to intermittent drainageways. They may make up about 60 percent of some delineations. The moderately well drained Seabrook soils are on the lower elevations and on the broad nearly level areas between drainageways. They make up about 25 percent of the delineations. The size of the delineations ranges from 300 to several thousand acres. The soils are used for woodland. This mapping unit has been designed to provide soils information for the present use of general forestry. Interpretations for other uses may require soil surveys of more detail.

Typically, Wando soils have surface layers of brown fine sand about 9 inches thick. The next layer is brownish yellow fine sand from 9 to about 30 inches with a few small concretions. Below this is strong brown and yellow fine sand to about 65 inches.

Typically, Seabrook soils have surface layers of dark grayish brown loamy fine sand about 5 inches thick. Below this is brown loamy fine sand from 5 to about 24 inches, and brownish yellow loamy fine sand from 24 to 45 inches mottled with light brownish gray and strong brown and contains a few small concretions. Below about 45 inches is light gray fine sand with strong brown mottles and a few concretions.

Included with these soils in mapping are small areas of a sandier soil that have hard pans in the subsoils. Also included are similar soils that have mildly alkaline reaction. These soils make up about 15 percent of the mapping unit.

Wando and Seabrook soils are medium to neutral in reaction throughout. The available water capacity and organic matter content is low, permeability is rapid, and shrink-swell potential is low. The seasonal high water table is below about 45 inches in Wando soils and below about 24 inches in the Seabrook soils. Wando and Seabrook soils are coarse textured and consistency is not changed much by changing moisture content. Surface layers have loose or very friable sandy soil.

The most important tree species growing on these soils are loblolly and longleaf pine. Other tree species are southern red oak, holly, red maple, bluejack oak, post oak, turkey oak, sassafras, persimmon, scarlet oak, and mockernut hickory. Vegetation is moderately dense. Forest litter is thin, but covers the soil surface. These soils are suited to openland and woodland wildlife. These soils have moderate limitations caused by wetness or sand texture for camp and picnic areas, playgrounds, paths and trails.

Bladen fine sandy loam (853):

The Bladen soil is wet and has poor tilth if worked wet. In areas where drained, it is suited for most locally grown plants. This mapping unit of Bladen soil was mapped in the following areas: industrial, residential, recreational and lawns.

Typically, the Bladen soil is on interstream areas. It is poorly drained. A typical profile has from 0 to 7 inches of black fine sandy loam. The next layer, from 7 to about 14 inches, is

light brownish gray or grayish brown fine sandy loam. The subsoil is gray clay from 14 to about 41 inches mottled with yellowish brown and dark red, and from 41 to about 60 inches is dark gray clay mottled with strong brown and red.

Included with this soil in mapping was a similar soil that has a thicker loam surface layer. It comprises about 15 percent of the mapping unit.

This mapping unit consists of Bladen soils that have been cleared of forests. The soil is nearly level. It is very strongly to strongly acid, unless limed. The available water capacity is medium to high, the organic matter content is low, permeability is slow and the shrink-swell potential is moderate. The surface runoff is slow to ponded and the seasonal high water table is at the surface. The Bladen soil is clayey and the consistency of the thin, fine sandy loam surface layer changes moderately with changes in moisture content. The consistency of the clayey subsoil changes significantly with changing moisture content.

Baymeade sand, 1 to 6 percent slopes (739)

The Baymeade soil is droughty, low in fertility, and leaches readily of plant nutrients. It is fairly suitable for most locally grown plants. Where vegetation is sparse, wind erosion can be a hazard. This mapping unit of Baymeade soils was mapped in the following areas: residential, recreational, industrial and lawns.

Typically, the Baymeade soil is near the larger drainageways. It is somewhat excessively drained. A typical profile has from 0 to 12 inches dark gray and dark grayish brown sand. The next layer, from 12 to 18 inches, is olive yellow sand mottled with dark brown coated sand and some small brown concretions and from 18 to 24 inches is olive yellow sand. The subsoil is olive yellow sandy loam from 24 to about 35 inches and light yellowish brown loamy sand mottled with strong brown from 35 to about 45 inches. Below this is white and very pale brown sand to about 80 inches.

Included with this soil in mapping were small areas of a soil that has more clay and a thicker subsoil and some small areas of Pactolus and Norfolk soils. Together these included soils comprise less than 20 percent of the mapping units.

This mapping unit consists of Baymeade soils that have been cleared of forest. The soil is slightly to very strongly acid throughout unless limed. The available water capacity is low, the organic matter content is low, permeability is moderately rapid, and the shrink-swell potential is low. The surface runoff is slow and the seasonal high water table remains below 4 feet. The Baymeade soil has coarse texture and the consistency of the sandy surface is not affected by changes in moisture content.

Craven fine sandy loam, 1 to 4 percent slopes (558B):

The Craven soil has slow infiltration, and surface runoff on the more sloping areas creates an erosion hazard. The eroded areas have poor tilth. Craven soils are suited for most locally grown plants. This Craven soil was mapped in the following areas: residential, recreational, industrial and lawns.

Typically, the Craven soil is near the drainageways. It is moderately well drained. A typical profile has from 0 to 4 inches of dark grayish brown fine sandy loam. The next layer is brown fine sandy loam from 4 to about 12 inches. The subsoil is yellowish brown sandy clay loam from 12 to 15 inches and yellowish brown clay from 15 to about 30 inches mottled with red and light brownish gray. Below this is gray clay from 30 to about 80 inches mottled with red and brownish yellow.

Included with this soil in mapping were small areas of similar soils that have sandy clay loam surface layers and some small areas of Onslow soils. Together, these soils comprise less than 15 percent of the mapping units.

This mapping unit consists of Craven soils that have been cleared for forest. The soil is very strongly to strongly acid unless limed. The available water capacity is medium, the organic matter content is low, permeability is slow and the shrink-swell potential is moderate. The surface runoff is medium and the seasonal high water table is about 2.5 feet. The Craven soil is clayey and the consistency of the thin, fine sandy loam surface layer changes moderately with changing moisture content. The consistency of the clayey subsoil changes significantly with changing moisture content.

Craven fine sandy loam, 4 to 8 percent slopes (558C):

This Craven soil was mapped in the following areas: residential, recreational, industrial and lawns.

This mapping unit consists of Craven soils that have been cleared of forest. This Craven soil has shorter and steeper slopes than the Craven fine sandy loam, 1 to 4 percent slopes. A rapid runoff and a greater erosion hazard is the main difference between this mapping unit and the Craven fine sandy loam, 1 to 4 percent slope.

Kureb sand, 0 to 6 percent slopes (704):

The Kureb soil is drouthy, low in fertility and leaches readily of plant nutrients. It is poorly suited for most locally grown plants. Vegetation is usually sparse and wind erosion can be a hazard to use. This mapping unit of Kureb sand was mapped in the following areas: industrial, residential and lawns.

Typically, the Kureb soil is on undulating interstream areas. They are excessively drained. A typical profile has from 0 to 8 inches of gray sand. Below this is light gray sand from 8 to about 18 inches. The next layer is brown and brownish yellow coated sand with a few lumps or concretions of dark reddish brown and tongues of light gray sand from 18 to about 28 inches. Below this layer is light gray and pale yellow sand to about 85 inches.

Included with this soil in mapping were small depressions occupied by Leon soils and Baymeade soils. These comprise less than 20 percent of the mapping unit.

This mapping unit consists of Kureb soils that have been cleared of forest. The soil is very strongly to strongly acid throughout, unless limed. The available water capacity is low, the organic matter content is low, permeability is rapid, and the shrink-swell potential is low.

The runoff is slow and the seasonal high water table remains below 6 feet. The Kureb soil has coarse texture and the consistency of the sand surface layer is not affected by changes in moisture content.

Leon Sand (582):

The Leon soil is low in fertility and leaches readily of plant nutrients. It is suited for a few species of locally grown plants. Where drained, the cut side slopes of ditches cave. The mapping unit of Leon sand was mapped in the following areas: industrial, recreational, residential and lawns.

Typically, the Leon soil is on broad interstream areas. It is poorly drained to somewhat poorly drained. A typical profile has from 0 to 3 inches of dark gray sand and below this is light gray sand from 3 to about 20 inches. The subsoil is dark reddish brown and black sand weakly cemented by humus coatings and bridging of grains. The next layer is light brownish gray sand to about 70 inches.

Included with this soil in mapping were long narrow depressions occupied by Lynn Haven and Murville soils. Together these comprise less than 10 percent of the mapping unit.

This mapping unit consists of Leon soils that have been cleared of forest. The soil is nearly level. It is extremely to strongly acid throughout unless limed. The available water capacity is low, the organic matter content is low, permeability is moderate in subsoil hard pan, and the shrink-swell potential is low. The surface runoff is slow and the seasonal high water table is from 10 to 30 inches for more than 9 months and recedes to about 40 inches in the dry seasons. The Leon soil has coarse texture and the consistency of the sand surface layer remains the same at different moisture content.

Newhan Soils, 2 to 15 percent slopes (708):

These soils are on undulating coastal ridges near beaches along the seacoast. The sand dunes are as much as 20 feet above sea level. The Newhan soils are excessively drained and make up most of these delineations. The size of these delineations ranges from 50 to about 500 acres. They are long and narrow. The soils are not suited to woodlands. This mapping unit has been designed to show areas that have very low potential for woodland. Recreation suitability of the soil is limited due to loose sand texture. However, they are adjacent to beaches and desirable sites for vacation cottages.

Typically, the Newhan soils have grayish brown sand surface layers about 2 inches thick and below this to about 75 inches is light gray sand with 5 to 20 percent small shell fragments.

Included in mapping are many small sinks occupied by Corolla and Duckston soils. These soils make up about 10 to 20 percent of the mapping unit.

Newhan soils are neutral to mildly alkaline in reaction. Available water capacity and organic matter content is very low, permeability is very rapid and shrink-swell potential is very low. Surface runoff is slow and internal drainage is rapid. The seasonal high water table is below

about 50 inches. The soils are coarse textured and consistency is not changed by changing moisture contents. The soils are loose sand.

The most important tree species growing in the Camp Lejeune mainland are not adapted to this soil. The vegetation consists of shrubs such as myrtle, yaupon, live oak, silverling and other plants like sea oats, big bluestern, beach pea, beach grasses and rush. The soils are poorly suited to management of openland wildlife and unsuited for woodland and wetland wildlife. The soils have severe limitations for most recreation due to soil blowing and loose sandy texture.

Norfolk loamy sand, 6 to 10 percent slopes (365C):

This Norfolk soil is on short slopes and is a hazard to use. It is well suited for most locally grown plants. This Norfolk soil was mapped in the following areas: industrial, residential, recreational and lawns.

Typically, this mapping unit of the Norfolk soils is on side slopes to large drainageways. It is well drained. A typical profile has from 0 to about 14 inches gray and light yellowish brown loamy sand. The subsoil is chiefly sandy clay loam from 14 to 85 inches. From 14 to about 36 inches is strong brown and below this is light olive brown mottled with light brownish gray, pale brown, and yellowish red.

Included with this soil in mapping were about 20 percent of Baymeade and 10 percent Craven soils.

This mapping unit consists of Norfolk soils that have been cleared of forest. This soil is very strongly to strongly acid throughout unless limed. The available water capacity is medium, the organic matter content is low, permeability is moderate, and the shrink-swell potential is low. The surface runoff is rapid and the seasonal high water table remains below 6 feet. The Norfolk soil has loamy texture and the consistency of the loamy sand surface layer changes only slightly with changes in moisture content.

Onslow fine sandy loam (415):

The Onslow soil is wet much of the time during the winter and spring unless drained. It is suited for most locally grown plants. This Onslow soil was mapped in the following areas: industrial, residential, recreational and lawns.

Typically, the Onslow soil is on broad smooth uplands near the large drainageways. It is somewhat poorly to moderately well drained. A typical profile has from 0 to about 8 inches of dark gray fine sandy loam. The next layer, from 8 to about 18 inches, is light olive brown and light yellowish brown fine sandy loam with many concretions of dark reddish brown and dark yellowish brown fine sandy loam in the 8 to 15 inch part. The subsoil is chiefly sandy clay loam from 18 to about 75 inches. It is light olive brown from 18 to 35 inches mottled with gray and brownish yellow and below this is gray mottled with brownish yellow, yellowish brown, and strong brown to about 75 inches.

Included with this soil in mapping were small areas of Woodington, Baymeade, Craven and Norfolk soils. Together these comprise about 20 percent of the mapping unit.



This mapping unit consists of Onslow soil that have been cleared of forest. The soil is nearly level. It is extremely to strongly acid throughout unless limed. The available water capacity is medium, the organic matter content is low, permeability is moderate, and the shrink-swell potential is low. The surface runoff is slow and the seasonal high water table ranges from 1.5 to 2.5 feet below the surface. The Onslow soil is loamy textured and the consistency of the fine sandy loam surface layer changes moderately with changes in moisture content.

Pactolus loamy sand (460):

The Pactolus soil is low in fertility, leaches readily of plant nutrients, and is wet during winter and spring but drouthy during summer. This soil is suited for most locally grown plants. This Pactolus soil was mapped in the following areas: industrial, residential, recreational and lawns.

Typically, the Pactolus soils are on the interstream areas. It is somewhat poorly to moderately well drained. A typical profile has from 0 to 6 inches dark grayish brown loamy sand. The next layer is yellowish brown and pale brown sand from 6 to about 36 inches. Below this is light brownish gray and light gray sand from 36 to 70 inches.

Included with this soil in mapping were small areas of Leon, Murville, and Lynn Haven. Together these soils comprise less than 25 percent of the mapping unit.

This mapping unit consists of Pactolus soils that have been cleared of forest. The soil is nearly level. It is very strongly to strongly acid throughout, unless limed. The available water capacity is low, the organic matter content is low, permeability is rapid and the shrink-swell potential is low. The surface runoff is slow and the seasonal high water table is about 2 feet. The Pactolus soil is coarse textured and the consistency of the loamy sand surface layer is not affected by changes in moisture content.

Torhunta fine sandy loam (870):

The Torhunta soil is wet except during long dry seasons. For most uses drainage is required. Cut side slopes of ditches are subject to caving. It is well suited for a few species of locally grown plants. This Torhunta soil was mapped in the following areas: industrial, residential, recreational and lawns.

Typically, the Torhunta soil is on broad flat interstream areas. It is very poorly drained. A typical profile has from 0 to 16 inches of black and very dark gray fine sandy loam. The sub-soil is gray sandy loam from 16 to about 45 inches, and gray and light gray loamy sand from 45 to about 80 inches.

Included with this soil in mapping were small areas of Pantego, Murville and Woodington soils. Together these comprise about 25 percent of the mapping units.

This mapping unit consists of Torhunta soils that have been cleared of forest. The soil is nearly level. It is very strongly to strongly acid throughout unless limed. The available water capacity is medium, the organic matter content is medium, permeability is moderately

rapid and the shrink-swell potential is low. The surface runoff is slow to ponded and the seasonal high water is at the surface. The Torhunta soil has loamy texture and the consistency of the fine sandy loam surface layer changes moderately with changes in moisture content.

Urban Land (6):

In the places between buildings and pavement are small areas of modified soils and some undisturbed soils. These places are used for grass and trees. Where undisturbed, most of the soils have a profile similar to that described as representative of the Onslow series.

This mapping unit consists of about 80 percent industrial buildings, streets, runways, and parking lots for aircraft and vehicles. Most of the rest is graded and shaped to accommodate drainage. The delineations are smooth and nearly level ranging in size from 25 to about 500 acres.

Urban Land - Onslow Soils Complex, 0 to 6 percent slopes (4):

In these delineations, the soils not covered by buildings and pavement are in lawns and shrubs. A few cut slopes are bare, but slopes are only 5 to about 20 feet in length and the hazard of erosion is only a minor problem.

This complex consists of about 25 to 50 percent buildings and pavement. The small areas of land between the buildings and pavement are mostly Onslow soils. The landscape is smooth and nearly level. These delineations are large ranging from 200 to about 500 acres.

This mapping unit consists of residences or quarters, driveways, streets, sidewalks and small playgrounds and Onslow soils. In some areas between buildings and pavement, the soils have been altered by grading, cutting, and filling to provide artificial drainageways. Where undisturbed, most of the soils have a profile similar to the one described as representative of the Onslow soils in the Onslow fine sandy loam mapping unit.

Wando fine sand (722):

The Wando soil is low in fertility, drouthy and leaches readily of plant nutrients. In areas where the vegetation is sparse, wind erosion is a hazard to use. It is fairly suited for most locally grown plants. This Wando was mapped in the following areas: residential, recreational, industrial and lawns.

Typically, the Wando soil is on uplands near the estuaries, sounds or oceans. It is excessively drained. A typical profile has from 0 to 9 inches of brown fine sand. The next layer from 9 to about 30 inches is brownish yellow fine sand with a few small concretions. Below this is strong brown and yellow fine sand to about 65 inches.

Included with this soil in mapping were shallow depressions occupied by Seabrook or Leon soils. Together these comprise about 20 percent of the mapping unit.

This mapping unit consists of Wando soils that have been cleared of forest. The soil is gently sloping. It is medium to neutral in reaction throughout. The available water capacity is low,

the organic matter content is low, permeability is rapid, and the shrink-swell potential is low. The surface runoff is slow and the seasonal high water table remains below 45 inches. The Wando soil has coarse texture and the consistency of the sand surface layer is not affected by changes in moisture content.

Woodington loamy sand (833):

The Woodington soil is wet except during long dry seasons. For most uses, drainage is needed. Cut side slopes of ditches are subject to caving. This soil is well suited for a few species of locally grown plants. This Woodington soil was mapped in the following areas: industrial, residential, recreational and lawns.

Typically, the Woodington soil is on broad smooth interstream areas. It is poorly drained. A typical profile has from 0 to 5 inches very dark gray loamy sand. Below this is light brownish gray loamy sand from 5 to 10 inches. The subsoil is gray sandy loam from 10 to about 65 inches and light brownish gray loamy sand from 65 to about 75 inches mottled with brownish yellow and light gray.

Included with this soil in mapping were about 15 percent Rains soil and 10 percent Torhunta soils.

This mapping unit consists of Woodington soils that have been cleared of forest. This soil is nearly level. It is very strongly to strongly acid throughout, unless limed. The available water capacity is medium, the organic matter content is low, permeability is moderately rapid and the shrink-swell potential is low. The surface runoff is slow and the seasonal high water table is at the surface. The Woodington soil is loamy and the consistency of the loamy sand surface layer changes only slightly with changes in moisture content.

Among properties of soils highly important in engineering are permeability, strength, compaction characteristics, soil drainage condition, shrink-swell potential, grain size, plasticity, and soil reaction. Also important are depth to the water table and soil slope. These properties, in various degrees and combinations, affect construction and maintenance of roads, airports, pipelines, foundations for small buildings, irrigation systems, ponds and small dams, and systems for disposal of sewage and refuse.

Information in this section of the soils interpretations can be helpful to those who:

1. Select potential residential, industrial, commercial and recreational areas.
2. Evaluate alternative routes for roads, highways, pipelines, runways and underground cables.
3. Seek sources of gravel, sand or clay.
4. Plan drainage systems, irrigation systems, ponds, terraces and other structures for controlling water and conserving soil.
5. Correlate performance of structures already built with properties of the kinds of soil on which they are built, for the purpose of predicting performance of structures on the same or similar kinds of soil in other locations.
6. Predict the trafficability of soils for cross-country movement of vehicles and construction equipment.
7. Develop preliminary estimates pertinent to construction in a particular area.

Most of the information in this section is presented in tables 11 and 12 which show, respectively, several estimated soil properties significant to engineering; interpretations for various engineering uses; and results of engineering laboratory tests on soil samples.

This information, along with the soil map and other parts of this publication, can be used to make interpretations in addition to those given in tables 11 and 12 and it also can be used to make other useful maps.

This information, however, does not eliminate need for further investigations at sites selected for engineering works, especially works that involve heavy loads or that require excavations to depths greater than those shown in the tables, generally depths greater than 6 feet. Also, inspection of sites, especially the small ones, is needed because many delineated areas of a given soil mapping unit may contain small areas of other kinds of soil that have strongly contrasting properties and different suitabilities or limitations for soil engineering.

Some of the terms used in this soil survey have special meaning to soil scientists that is not known to all engineers. They should consult the local soil conservation service representative for this information.

## 1. Engineering Soil Classification Systems

The two systems most commonly used in classifying samples of soils for engineering are the Unified system used by the SCS engineers, Department of Defense and others, and the AASHO system adopted by the American Association of State Highway Officials.

In the Unified system, soils are classified according to particle size distribution, plasticity, liquid limit, and organic matter. Soils are grouped in 15 classes. There are eight classes of coarse-grained soils, identified as GW, GP, GM, SC, SW, SP, SM and SC; six classes of fine-grained soils, identified as ML, CL, OL, MH, CH, and OH; and one class of highly organic soils, identified at Pt. Soils on the borderline between two classes are designated by symbols for both classes; for example, ML-CL.

The AASHO system is used to classify soils according to those properties that affect us in highway construction and maintenance. In this system, a soil is placed in one of seven basic groups ranging from A-1 through A-7 on the basis of grain-size distribution, liquid limit, and plasticity index. In group A-1 are gravelly soils of high bearing strength, or the best soils for subgrade (foundation). At the other extreme, in group A-7, are clay soils that have low strength when wet and that are the poorest soils for subgrade. Where laboratory data are available to justify a further breakdown, the A-1, A-2 and A-7 groups are divided as follows: A-1-a, A-1-b, A-2-4, A-2-5, A-2-6, A-2-7, A-7-5 and A-7-6. As additional refinement, the engineering value of a soil material can be indicated by a group index number. Group indexes range from 0 for the best material to 20 or more for the poorest. The AASHO classification is given in table 11 for all soils mapped in the survey area.

## 2. Soil Properties Significant to Engineering

Several estimated soil properties significant in engineering are given in table 11. These estimates are made for typical soil profiles, by layers sufficiently different to have different significance for soil engineering. The estimates are based on field observation made in the course of mapping, on test data for these and similar soils, and on experience with the same kinds of soil in other counties. Following are explanations of some of the columns in table 11.

Flood hazard is described in terms of the frequency of occurrence and the duration of flooding.

Depth to seasonal high water table is distance from the surface of the soil to the highest level that ground water reaches in the soil in most years.

Subsidence is settlement after drainage of organic soils or of soils containing semi-fluid mineral layers. Ratings for subsidence take into account (1) rapid initial loss of elevation resulting from loss of ground water buoyancy, and (2) later and slower loss of elevation that results from oxidation of organic materials. The maximum possible loss of surface elevation is called potential subsidence.

Soil texture is described in table 11 in the standard terms used by the Department of Agriculture. These terms take into account relative percentages of sand, silt, and clay in soil material that is less than 2 millimeters in diameter. "Loam," for example, is soil material that contains 7 to 27 percent clay, 28 to 50 percent silt, and less than 52 percent sand. If the soil contains gravel or other particles coarser than sand, an appropriate modifier is added; for example, "gravelly loamy sand."

Liquid limit and plasticity index indicate the effect of water on the strength and consistence of soil material. As the moisture content of a clayey soil is increased from a dry state, the material changes from a semisolid to a plastic state. If the moisture content is further increased, the material changes from a plastic to a liquid state. The plastic limit is the moisture content at which the soil material changes from the semisolid to plastic state; and the liquid limit from a plastic to a liquid state. The plasticity index is the numerical difference between the liquid limit and the plastic limit. It indicates the range of moisture content within which a soil material is plastic. Liquid limit and plasticity index are estimated in table 11.

Permeability is that quality of a soil that enables it to transmit water or air. It is estimated on basis of those soil characteristics observed in the field, particularly structure and texture. The estimates in table 11 do not take into account lateral seepage or such transient soil features as plowpans and surface crusts.

Available water capacity is the ability of soils to hold water for use by most plants. It is commonly defined as the difference between the amount of water in the soil at field capacity and the amount at the wilting point of most crop plants.

Reaction is the degree of acidity or alkalinity of a soil expressed in pH values.

Shrink-swell potential is the relative change in volume to be expected of soil material with changes in moisture content; that is, the extent to which the soil shrinks as it dries out or swells when it gets wet. Extent of shrinking and swelling is influenced by the amount and kind of clay in the soil. Shrinking and swelling of soils cause much damage to building foundations, roads, and other structures. A high shrink-swell potential indicates a hazard to maintenance of structures built in, on or with material having this rating.

Corrosivity, as used in table 11, pertains to potential soil-induced chemical action that dissolves or weakens uncoated steel or concrete. Rate of corrosion of uncoated steel is related to soil properties such as drainage, texture, total acidity, and electrical conductivity of the soil material. Corrosivity for concrete is influenced mainly by the content of sodium or magnesium sulfate, but also by soil texture and acidity. Installations of uncoated steel that intersect soil boundaries or soil horizons are more susceptible to corrosion than installations entirely in one kind of soil or in a low probability of soil-induced corrosion damage. A rating of high means that there is a high probability of damage, so that protective measures for steel and more resistant concrete should be used to avoid or minimize damage.

The estimated interpretations in table 12 are based on the engineering properties of soils shown in table 11, on test data for soils in this survey area and others nearby or adjoining, and on the experience of engineers and soil scientists with the soils of Camp Lejeune.

Soil limitations are indicated by the ratings slight, moderate and severe. Slight means soil properties generally favorable for the rated use, or in other words, limitations that are minor and easily overcome or modified by special planning and design. Severe means soil properties so unfavorable and so difficult to correct or overcome as to require major soil reclamation, special designs, or intensive maintenance. For some uses, the rating of severe is divided to obtain ratings of severe and very severe. Very severe means one or more soil properties so unfavorable for a particular use that overcoming the limitations is most difficult and costly.

Soil suitability is rated by the terms good, fair and poor, which have, respectively, meanings approximately parallel to the terms slight, moderate and severe.

Following are explanations of some of the columns in table 12:

Septic tank absorption fields are subsurface systems of tile or perforated pipe that distribute effluent from a septic tank into natural soil. The soil material from a depth of 18 inches to 6 feet is evaluated. The soil properties considered are those that affect both absorption of effluent and construction and operation of the system. Properties that affect absorption are permeability, depth to water table and susceptibility to flooding. Slope is a soil property that affects difficulty of layout and construction and also the risk of soil erosion, lateral seepage and downslope flow of effluent.

Sewage lagoons are shallow ponds constructed to hold sewage within a depth of 2 to 5 feet long enough for bacteria to decompose the solids. A lagoon has a nearly level floor and sides, or embankments, of compacted soil material. The assumption is made that the embankment is compacted to medium density and the pond is protected from flooding. Properties are considered that affect the pond floor and the embankment. Those that affect the pond floor are permeability, organic matter and slope; and depth to marl, if present, becomes important. The soil properties that affect the embankment are the engineering properties of the embankment material as interpreted from the Unified Soil Classification.

Sanitary landfill is a method of disposing of refuse in dug trenches. The waste is spread in thin layers, compacted, and covered with soil throughout the disposal period. Landfill areas are subject to heavy vehicular traffic. Some soil properties that affect suitability for landfill are ease of excavation, hazard of polluting ground water and trafficability. The best soils have moderately slow permeability, withstand heavy traffic and are friable and easy to excavate. Unless otherwise stated, the ratings in table apply only to a depth of about 6 feet, and therefore limitation ratings of slight or moderate may not be valid if trenches are to be much deeper than that. For some soils, reliable predictions can be made to a depth of 10 or 15 feet, but regardless of that, every site should be investigated before it is selected.

Shallow excavations are those that require digging or trenching to a depth of less than 6 feet, as for example, excavations for pipelines, sewer lines, phone and power transmission lines, basements, open ditches and cemeteries. Desirable soil properties are good workability, moderate resistance to sloughing, gentle slopes, absence of marl, and freedom from flooding or a high water table.

Dwellings, as rated in table 12a, are not more than three stories high and are supported by foundation footings placed in undisturbed soil. The features that affect the rating of a soil for dwellings are those that relate to capacity to support load and resist settlement under load, and those that relate to ease of excavation. Soil properties that affect capacity to support load are wetness, susceptibility to flooding, density, plasticity, texture and shrink-swell potential. Those that affect excavation are wetness, slope and depth to marl.

Ratings for small commercial buildings are for the undisturbed soils that are used to support building foundations. Emphasis is on foundations, ease of excavation for underground utilities and corrosion potential of uncoated steel pipe. The undisturbed soil is rated for spread footing foundations for buildings less than three stories high or foundation loads not in excess of that weight. Properties affecting load-supporting capacity and settlement under load are wetness, flooding, texture, plasticity, density and shrink-swell behavior. Properties affecting excavation are wetness, flooding, slope and depth to marl. Properties affecting corrosion of buried uncoated steel pipe are wetness, texture, total acidity and electrical resistivity.

Local roads and streets, as rated in table 12a, have an all-weather surface expected to carry automobile traffic all year. They have a subgrade of underlying soil material; a base consisting of gravel, crushed rock or soil material stabilized with lime or cement; and a flexible or rigid surface, commonly asphalt or concrete. These roads are graded to shed water and have ordinary provisions for drainage. They are built mainly from soil at hand, and most cuts and fills are less than 6 feet deep. Soil properties that most affect design and construction of roads and streets are load supporting capacity and stability of the subgrade, and the workability and quantity of cut and fill material available. The AASHO and Unified classifications of the soil material and also the shrink-swell potential indicate load supporting capacity. Wetness and flooding affect stability of the material. Slope, depth to marl and wetness affect ease of excavation and amount of cut and fill needed to reach an even grade.

Pond reservoir areas hold water behind a dam or embankment. Soils suitable for pond reservoir areas have low seepage, which is related to their permeability and depth to permeable material.

Embankments, dikes and levees require soil material resistant to seepage and piping and of favorable stability, shrink-swell potential, shear strength and compactibility. Presence of stones or organic material in a soil are among factors that are unfavorable.

An aquifer-fed excavated pond is a body of water created by excavating a pit or dugout into a ground-water aquifer. Excluded are ponds fed by runoff and also embankment-type ponds where the depth of water impounded against the embankment exceeds three feet. The assumption is made that the pond is properly designed, located and constructed, and that the water is of



good quality. Properties affecting aquifer-fed ponds are the existence of a permanent water table; slope; stability in ditchbanks; susceptibility to stream overflow; and availability of outlets for drainage.

Drainage is affected by such soil properties as permeability, texture and structure; depth to clay pan, marl or other layers that influence rate of water movement; depth to the water table; slope; stability in ditchbanks; susceptibility to stream overflow; and availability of outlets for drainage.

Irrigation of a soil is affected by such features as slope; susceptibility to stream overflow, water erosion or soil blowing; soil texture; content of stones; depth of root zone rate of water intake at the surface layer and other layers that restrict movement of water; amount of water held available to plants; and the need for drainage, or depth to water table.

Terraces and diversions are affected by such soil features as percent, length and shape of slope; depth to water table; hazards of erosion; texture and permeability; potential for siltation of channels; difficulty in the growing of plants; and availability of outlets.

Grassed waterways are affected by such soil features as erodibility; texture and thickness of soil layers; natural drainage; steepness of slope; potential for siltation of channels, including accumulation from soil blowing; and available water capacity.

Road fill is soil material used in embankments for roads. The suitability ratings reflect (1) the predicted performance of soil after it has been placed in an embankment that has been properly compacted and provided with adequate drainage and (2) the relative ease of excavating the material at borrow areas.

Sand and gravel are used in great quantities in many kinds of construction. The ratings in table 15c provide guidance about where to look for probable sources. A soil rated as a source of sand or gravel generally has a layer at least 3 feet thick, the top of which is within a depth of 6 feet. The ratings do not take into account thickness of overburden, location of the water table, or other factors that affect mining of the materials, and neither do they indicate quality of the deposit.

Topsoil is used for topdressing an area where vegetation is to be established and maintained. Suitability is affected mainly by ease of working and spreading the soil material, as for preparing a seedbed; natural fertility of the material, or its response of plants when fertilizer is applied; and absence of substances toxic to plants. Texture of the soil material and its characteristics that affect suitability, but also considered in the ratings is damage that will result at the area from which topsoil is taken.

Table 11

ESTIMATED PHYSICAL AND CHEMICAL PROPERTIES OF SOILS Camp Lejeune, Onslow COUNTY, NORTH CAROLINA

FIELD MAP SYMBOL	SOIL NAME AND MAP SYMBOLS	FLOODING	DEPTH TO SEASONALLY HIGH WATER TABLE	DEPTH FROM SURFACE (REF. PROFILE)	CLASSIFICATION			PERCENTAGE LESS THAN 3 INCHES PASSING SIEVE --				LIQUID LIMIT	PLASTICITY INDEX	PERMEABILITY	AVAILABLE WATER CAPACITY	REACTION	SHRINK-SWELL POTENTIAL	CORROSIVITY	
					TEXTURE USDA	UNIFIED	ASSHO	NO. 4	NO. 10	NO. 40	NO. 200							Uncoated Steel	Concrete
EA 739	Baymeade	None	3.5-5	0-36 36-49 49-78	Sand Sandy loam sandy clay loam Loamy sand sand	SM,SP-SM SC,SM-SC CL,CL-ML SM,SP-SM	A-2,A-3 A-2,A-4 A-2,A-3	100	100	50-70 60-90 50-75*	5-15 30-55 5-30	- 10-20 NP	NP 5-9 NP	6.0-20.0 2.6-6.0 6.0-20.0	0.02-0.06 0.10-0.14 0.02-0.10	5.1-6.5 5.1-6.5 5.1-6.5	Low	Low	High
BJ	Bibb	Frequent	Surface	0-37 3-60	Sandy loam Sandy loam loamy sand loam	SM,ML SM,ML CL	A-2,A-2 A-2,A-4 A-6	95-100 60-100	90-100 50-100	60-90 40-100	30-60 30-90	0-40 15-40	0-12 4-14	0.6-2.0 0.6-2.0	0.2-0.10 0.12-0.20	4.5-5.5 4.5-5.5	Low	High	High
853	Bladen	None	Surface	0-14 14-65	Fine sandy loam Clay	ML CL,CH	A-4 A-7	100 100	100	95-100 95-100	50-65 65-80	30-36 45-69	4-9 22-35	0.6-2.0 <.2	0.10-0.13 0.10-0.12	4.5-5.5 4.5-5.5	Low Moderate	High	High
CA	Capers	Frequent by tides	Surface	0-19 19-65	Loam, clay loam Clay, silty clay	CL,CH CH	A-7 A-7	100 100	100	85-100 90-100	60-90 60-90	30-60 65-85	20-40 40-55	0.10-0.18 0.06-0.2	0.10-0.18 0.12-0.30	6.6-7.8 6.6-7.8	Moderate High	High	Low
CD	Corolla	Frequent	1.5-3.0	0-72	Sand	SM,SP-SM	A-2,A-3	100	98-100	60-75	3-12	-	NP	>20	0.02-0.05	5.6-7.8	Low	Low	Low
558B 558C	Craven	None	2.5	0-7 7-55 55-65	Fine sandy loam Clay Clay loam	ML CH CH,CL	A-4 A-7 A-7	100 100	100	85-100 90-100 90-100	51-70 70-95 55-85	- 51-60 15-35	NP 18-35 15-35	0.6-2.0 0.06-.20 0.06-.20	0.12-0.18 0.12-0.15 0.12-0.15	4.5-6.0 4.5-5.5 4.5-5.5	Low Moderate Moderate	High	High
CD	Duckston	Flooded by high storm tides	Surface	0-72	Sand	SM,SP-SM	A-2,A-3	100	95-100	60-75	3-10	-	NP	>20	0.02-0.05	5.6-7.8	Low	High	Low
BJ	Johnston	Frequent	Surface	0-30 30-60	Loam Sandy loam loamy sand	ML,SM SM,SP-SM	A-2,A-4 A-2,A-4	100	100	80-95 50-85	30-75 5-55	35 35	NP-10 NP-10	0.6-2.0 0.6-20.0	0.10-0.20 0.08-0.12	4.5-5.5 4.5-5.5	Low	Moderate	High
KL 704	Kureb	None	> 6	0-80	Sand	SP	A-3	100	100	60-95	0-5	-	NP	6.0-20.0	0.05	4.5-7.3	Low	Low	Moderate
KL	Lakeland	None	> 6	0-43 43-90	Sand Sand	SP-SM SP,SP-SM	A-3,A-2 -4,A-3 A-2-4	90-100	90-100	60-100 50-100	5-12 1-12	- -	NP NP	>20 >20	0.05-0.08 0.03-0.08	4.5-6.0 4.5-6.0	Low	Low	Moderate
LN	Leon	None	0.5	0-15 15-30 30-80	Sand	SP,SP-SM	A-3,A-2 -4	100	100	80-100	2-12 5-12 2-12	-	NP	6.0-2.0 0.60-6.0 >20	0.01-0.05 0.05-0.10 0.01-0.05	4.0-5.5	Low	Low	High

Table 11

## ESTIMATED PHYSICAL AND CHEMICAL PROPERTIES OF SOILS Camp Lejeune, Onslow COUNTY, NORTH CAROLINA

FIELD MAP SYMBOL	SOIL NAME AND MAP SYMBOLS	FLOODING	DEPTH TO SEASONALLY HIGH WATER TABLE	DEPTH FROM SURFACE (REP. PROFILE)	CLASSIFICATION			PERCENTAGE LESS THAN 3 INCHES PASSING SIEVE - -				LIQUID LIMIT	PLASTICITY INDEX	PERMEABILITY	AVAILABLE WATER CAPACITY	REACTION	SHRINK-SWELL POTENTIAL	CORROSION	
					TEXTURE USDA	UNIFIED	ASSHO	NO. 4	NO. 10	NO 40	NO 200							Uncoated Steel	Concrete
		Feet	Feet	Inches									In/hr	In/in	pH				
RL	Lynchburg	None	<1	0-15 15-63 63-72	Sandy loam Sandy clay loam Sandy clay loam	SM SC,CL,SM SC,CL,SM	A-2-4 A-4,A-6 A-4,A-6	100	100	60-98 70-98 60-98	22-35 36-60 30-55	25 15-30 10-30	NP-6 4-20 5-15	2.0-6.0 0.6-2.0 0.6-2.0	0.09-0.13 0.12-0.16 0.12-0.16	4.3-5.5	Low	High	High
LM	Lynn Haven	None	Surface	0-16 16-30 30-75	Fine sand	SP,SP-SM A-3 A-2-4	100	100	80-100	2-12 5-20 2-12	-	NP	6.0-20.0 0.6-6.0 20	0.02-0.05 0.05-0.10 0.01-0.05	4.0-5.5	Low	High	High	
LM	Murville	None	Surface	0-8 8-45 45-56	Fine sand	SM,SP-SM A-2	100	100	95-100	5-20 12-20 5-12	-	NP	6.0-20.0 2.0-6.0 6.0-20.0	0.06-0.08 0.06-0.08 0.05-0.07	4.5-5.5	Low	High	High	
708	Newhan	None	6	0-65	Sand	SP A-3	95-100	95-100	60-75	0-5	-	NP	20.0	0.05	6.6-7.8	Low	Low	Low	
ON 415	Norfolk	None	6	0-17 17-82	Loamy sand Sandy clay loam	SM,SM-SC SC,SM-SC	A-2,A-4 A-2,A-4 A-6	100	95-100 91-100	50-91 70-90	15-33 30-49	25 20-35	NP-4 4-15	2.0-6.0 0.6-2.0	0.06-0.10 0.00-0.15	4.5-6.0 4.5-5.5	Low	Moderate	High
ON	Onslow	None	1.5	0-18 18-58 58-75	Loamy fine sand Sandy loam Sandy clay loam Sandy loam Sandy clay loam, sandy loam clay loam	SM,SP-SM SM,CL, SM-SC SM,SC,CL	A-2 A-2,A-4 A-6 A-2,A-4 A-6	100	100	60-85 70-95 60-90	5-30 30-55 30-35	- 15 30	NP NP-12 NP-27	2.0-6.0 2.0-6.0 0.6-6.0	0.07-0.11 0.11-0.15 0.12-0.17	4.0-5.5	Low	Moderate	High
460	Pactolus	None	1.5	0-40 40-80	Loamy sand Loamy sand sand	SM SM,SP-SM	A-2	100	90-100	51-95	13-30 5-30	-	NP	6.0-20.0 0.05-0.10 0.03-0.07	4.5-6.0 4.5-5.5	Low	Low	High	
FM	Pamlico	Frequent	Surface	0-30 3-60	Muck Loamy sand sand	PT SM,SP-SM	A-2,A-3	100	100	70-80	5-20	-	NP	0.6-2.0 6.0-20.0	0.24-0.26 0.03-0.06	3.6-5.0	Low	Moderate	High
TP	Pantego	None	Surface	0-18 18-65	Fine sandy loam Sandy clay loam, clay loam	SM,SM-SC ML SC,CL	A-2,A-4 A-4,A-6	100	100	60-95 95-100	30-75 80-100	30 25-40	NP-12 8-16	2.0-6.0 0.6-2.0	0.10-0.20 0.12-0.20	4.5-5.5	Low	Moderate	High
RL	Rains	None	Surface	0-12 12-62 62-82	Sandy loam Sandy clay loam Sandy clay loam, sandy loam, clay loam	SM SC,SM-SC SC,SM-SC ML,CL	A-2 A-2,A-4 A-2,2-4	100	98-100 98-100 95-100	80-98 75-98 70-98	30-55 30-70 30-60	20-45 20-50 15-40	NP-10 5-20 5-18	2.0-6.0 0.6-2.0 0.6-2.0	0.08-0.12 0.10-0.15 0.10-0.15	4.5-6.5 4.5-6.5 4.5-5.5	Low	High	High

Table 11

ESTIMATED PHYSICAL AND CHEMICAL PROPERTIES OF SOILS Camp Lejeune, Onslow COUNTY, NORTH CAROLINA

FIELD MAP SYMBOL	SOIL NAME AND MAP SYMBOLS	FLOODING	DEPTH TO SEASONALLY HIGH WATER TABLE	DEPTH FROM SURFACE (REP. PROFILE)	CLASSIFICATION			PERCENTAGE LESS THAN 3 INCHES PASSING SIEVE - -				LIQUID LIMIT	PLASTICITY INDEX	PERMEABILITY	AVAILABLE WATER CAPACITY	REACTION	SHRINK-SWELL POTENTIAL	CORROSIVITY	
					TEXTURE USDA	UNIFIED	ASSHO	NO. 4	NO. 10	NO. 40	NO. 200							Uncoated Steel	Concrete
WA	Seabrook	None	2	0-9 9-65	Loamy fine sand, sand	SM, SP-SM	A-2 A-2, A-3	100	90-100	90-100	10-20 8-20	-	NP	2.0-6.3 6.3-20.0	0.05-0.08 0.05-0.08	5.1-6.0 4.5-5.5	Low	Low	High
TP	Torhunta	None	Surface	0-15 15-40 40-80	Fine sandy loam Sandy loam Loamy sand Sandy loam Sand	SM SM SM, SP-SM SM	A-2, 2-4 A-2, A-4	100	95-100	70-85 70-85 65-85	20-49 20-40 5-25	20 20 -	NP	2.0-6.0 2.0-6.0 6.0-20.0	0.10-0.15 0.10-0.15 <.05	4.0-5.5	Low	High	High
WA 722	Wando	None	>3.5	0-51 51-65	Loamy fine sand Fine sand	SM SM, SP-SM	A-2 A-2, A-3	96-100 98-100	95-100 98-100	60-98 51-98	12-30 5-20	-	NP	6.0-20.0 6.0-20.0	0.05-0.08 0.03-0.08	5.6-7.3 5.6-7.3	Low	Low	Low
833	Woodington	None	Surface	0-12 12-47 47-85	Loamy fine sand Sandy loam Loamy sand sandy loam	SM SM SM, SP-SM SM	A-2 A-2, A-4 A-2, A-4	100	95-100	50-85 50-95 50-85	15-30 20-50 10-30	- <25 -	NP NP-3 NP	2.0-6.0 2.0-6.0 6.0-20.0	0.06-0.11 0.10-0.15 0.06-0.11	4.0-5.5	Low	High	High

Table 12a

## Interpretations of Engineering Properties of the Soils

## COMMUNITY DEVELOPMENT

Soil Series and Map Symbols	Degree of Limitations				
	Shallow Excavations	Dwellings Without Basements	Dwellings With Basements	Small Commercial Buildings	Local Roads & Streets
Baymeade 739 BA	Moderate-cut banks cave	Slight	Moderate- seasonal high water table	1-4% slope: moderate- seasonal high water table- 4-6% slope: moderate	0-8% slope: slight- 8% slope: moderate
Bibb BJ	Severe-flooding high water table	Severe-flood- ing, high water table	Severe-flood- ing, high water table	Severe-flood- ing, high water table	Severe-flooding, high water table
Bladen 853	Severe- seasonal high water table, ponding	Severe- seasonal high water table, ponding	Severe- seasonal high water table, ponding, too clayey	Severe- seasonal high water table, ponding, too clayey	Severe-poorly drained, ponding too clayey
Capers CA	Severe-tidal flooding, high water table	Severe-tidal flooding, high water table	Severe-tidal flooding	Severe-tidal flooding, high shrink	Severe-tidal flooding, high shrink
Corolla CD	Severe- seasonal high water table, cut banks cave	Severe- seasonal high water table	Severe- seasonal high water table	Severe- seasonal high water table	Severe-somewhat poorly drained
Craven 558B 558C	Moderate- seasonal high water table	Moderate- too clayey	Severe-too clayey, season- al high water table	Severe-too clayey	Severe-too clayey
Duckston CD	Severe-high water table, cut banks cave	Severe-high water table	Severe-high water table	Severe-high water table	Severe-high water table
Johnston BJ	Severe-flooding high water table	Severe- flooding, high water table	Severe- flooding, high water table	Severe- flooding, high water table	Severe-flooding, high water table
Kureb KL 704	Severe-cut banks cave	0-8% slope: slight- 8-15% slope: moderate- 15-25% slope: severe	0-8% slope: slight- 8-15% slope: moderate- 15-25% slope: severe	0-4% slope: slight- 4-8% slope: moderate- 8-20% slope: severe	0-8% slope: slight- 8-15% slope: moderate- 15-20% slope: severe

Table 12a

## Interpretations of Engineering Properties of the Soils

## COMMUNITY DEVELOPMENT

Soil Series and Map Symbols	Degree of Limitations				
	Shallow Excavations	Dwellings Without Basements	Dwellings With Basements	Small Commercial Buildings	Local Roads & Streets
Lakeland KL	Severe—cut banks cave	0-8% slope: slight— 8-15% slope: moderate— 15-30% slope: severe	0-8% slope: slight— 8-15% slope: moderate— 15-30% slope: severe	0-4% slope: slight— 4-8% slope: moderate— 8-20% slope: severe	0-8% slope: slight— 8-15% slope: moderate— 15-30% slope: severe
Leon LN 582	Severe— seasonal high water table, cut banks cave	Severe— seasonal high water table	Severe— seasonal high water table	Severe— seasonal high water table	Severe—poorly drained
Lynchburg RL	Severe— seasonal high water table	Severe— seasonal high water table	Severe— seasonal high water table	Severe— seasonal high water table	Severe—somewhat poorly drained
Lynn Haven LM	Severe—high water table, cut banks cave ponding	Severe—high water table, ponding	Severe—high water table, ponding	Severe—high water table, ponding	Severe—very poorly drained
Murville LM	Severe—high water table, cut banks cave ponding	Severe—high water table, ponding	Severe—high water table, ponding	Severe—high water table, ponding	Severe—high poorly drained
Newhan 708	Severe—cut banks cave	2-8% slope: slight— 8-15% slope: moderate	2-8% slope: slight— 8-15% slope: moderate	2-4% slope: slight— 4-8% slope: moderate— 8-30% slope: severe	2-8% slope: slight— 8-15% slope: moderate
Norfolk ON 365C	0-8% slope: slight— 8-10% slope: moderate	0-8% slope: slight— 8-10% slope: moderate	0-8% slope: slight— 8-10% slope: moderate	0-4% slope: slight— 4-8% slope: moderate 8-10% slope: severe	0-8% slope: slight— 8-10% slope: moderate
Onslow ON 415	Moderate— seasonal high water table	Moderate— seasonal high water table	Moderate— seasonal high water table	Moderate— seasonal high water table	Slight
Pactolus 460	Severe— seasonal high water table, cut banks cave	Moderate— seasonal high water table	Severe— seasonal high water table	Severe— seasonal high water table	Moderate— somewhat poorly drained

Table 12a

## Interpretations of Engineering Properties of the Soils

## COMMUNITY DEVELOPMENT

Soil Series and Map Symbols	Degree of Limitations				
	Shallow Excavations	Dwellings Without Basements	Dwellings With Basements	Small Commercial Buildings	Local Roads & Streets
Pamlico PM	Severe-wet, ponding	Severe-wet, ponding, low bearing capacity	Severe-wet, ponding, low bearing capacity	Severe-wet, ponding, low bearing capacity	Severe-very poorly drained, ponding, low bearing capacity
Pantego TP	Severe- seasonal high water table, ponding	Severe- seasonal high water table, ponding	Severe- seasonal high water table, ponding	Severe- seasonal high water table, ponding	Severe-very poorly drained
Rains RL	Severe- seasonal high water table, ponding	Severe- seasonal high water table, ponding	Severe- seasonal high water table, ponding	Severe- seasonal high water table, ponding	Severe-poorly drained, ponding
Seabrook WA	Severe-cut banks cave, seasonal high water table	Moderate- seasonal high water table	Severe- seasonal high water table	Moderate- seasonal high water table	Slight
Torhunta TP 870	Severe- seasonal high water table, ponding	Severe- seasonal high water table, ponding	Severe- seasonal high water table, ponding	Severe- seasonal high water table, ponding	Severe- seasonal high water table, ponding
Wando WA 722	Severe-cut banks cave	Slight	Slight	0-4% slope: slight— 4-8% slope: moderate	Slight
Woodington 833	Severe-cut banks cave, seasonal high water table, ponding	Severe- seasonal high water table, ponding	Severe- seasonal high water table, ponding	Severe- seasonal high water table, ponding	Severe-poorly drained, ponding

Table 12b.

## Interpretations of Engineering Properties of the Soils

## SANITARY FACILITIES

Soil Series and Map Symbols	Degree of Limitations				
	Septic Tank Absorption Field	Sewage Lagoons	Sanitary Landfill (Trench)	Sanitary Landfill (Area)	Daily Cover for Landfill
Baymeade 739 BA	Moderate- seasonal high water table	Severe-percs rapidly	Severe- seepage, seasonal high water table	Severe- seepage	Fair-too sandy
Bibb BJ	Severe-flooding high water table	Severe- flooding, high water table	Severe- flooding, high water table	Severe- flooding, high water table	Poor-wet
Bladen 853	Severe- seasonal high water table, percs slowly, ponding	Severe- seasonal high water table	Severe- seasonal high water table, clayey soil, ponding	Severe- seasonal high water table	Poor-very firm consistent, clay- ey, too wet
Capers CA	Severe-tidal flooding, high water table	Severe-tidal flooding, high water table	Severe-tidal flooding, high water table, clay- ey soil	Severe-tidal flooding, high water table	Poor-firm consistent, clayey, wet
Corolla CD	Severe- seasonal high water table	Severe- seasonal high water table, percs rapid- ly	Severe- seasonal high water table seepage	Severe- seasonal high water table, seepage	Poor-wet, too sandy
Craven 558B 558C	Severe- seasonal high water table, percs slowly	0-2% slopes: slight- 2-7% slopes: moderate- 7-12% slopes: severe	Severe- seasonal high water table, clayey soil	Severe- seasonal high water table	Poor-firm consistent, too clayey
Duckston CD	Severe- high water table	Severe-high water table, percs rapid- ly	Severe-high water table, seepage	Severe-high water table, seepage	Poor-too sandy
Johnston BJ	Severe-flooding high water table	Severe- flooding, high water table	Severe- flooding, high water table	Severe- flooding, high water table	Poor-wet
Kureb KL 704	0-8% slope: slight- 8-15% slope: moderate- 15-25% slope: severe-	Severe-percs rapidly	Severe-too sandy, seepage	Severe- seepage	Poor-too sandy



Table 12b.

## Interpretations of Engineering Properties of the Soils

## SANITARY FACILITIES

Soil Series and Map Symbols	Degree of Limitations				
	Septic Tank Absorption Fields	Sewage Lagoons	Sanitary Landfill (Trench)	Sanitary Landfill (Area)	Daily Cover for Landfill
Lakeland KL	0-8% slope: slight— 8-15% slope: moderate— 15-30% slope: severe	Severe-percs rapidly	Severe-too sandy, seepage	Severe- seepage	Poor-too sandy
Leon LN 582	Severe- seasonal high water table	Severe-percs rapidly, seasonal high water table	Severe- seasonal high water table, seepage, too sandy	Severe- seasonal high water table, seepage	Poor-too sandy
Lynchburg RL	Severe- seasonal high water table	Severe- seasonal high water table	Severe- seasonal high water table	Severe- seasonal high water table	Good
Lynn Haven LM	Severe- high water table, ponding	Severe-high water table, percs rapidly	Severe-high water table, ponding	Severe-high water table, ponding	Poor-too sandy, wet
Murville IM	Severe-high water table, ponding	Severe-high water table, perc rapidly	Severe-high water table, ponding	Severe-high water table, ponding	Poor-wet
Newhan 708	2-8% slope: slight— 8-10% slope: moderate	Severe-percs rapidly	Severe-too sandy, seepage	Severe- seepage	Poor-too sandy
Norfolk ON 365C	0-8% slope: slight— 8-10% slope: moderate	0-2% slope: moderate— percs rapidly 2-7% slope: moderate— percs rapidly 7-10% slope: severe	Slight	0-8% slope: slight— 8-10% slope: moderate	Good
Onslow ON 415	Severe- seasonal high water table	Severe- seasonal high water table	Moderate- seasonal high water table, seepage	Severe- seasonal high water table, seepage	Good
Pactolus 460	Severe- seasonal high water table	Severe- seasonal high water table, percs rapidly	Severe- seasonal high water table, seepage	Severe- seasonal high water table, seepage	Fair-too sandy
Pamlico PM	Severe- wet, ponding	Severe- wet	Severe- wet ponding	Severe- wet ponding	Poor-high organic matter content, wet

Table 12b.

## Interpretations of Engineering Properties of the Soils

## SANITARY FACILITIES

Soil Series and Map Symbols	Degree of Limitations				
	Septic Tank Absorption Field	Sewage Lagoons	Sanitary Landfill (Trench)	Sanitary Landfill (Area)	Daily Cover for Landfill
Pantego TP	Severe- seasonal high water table, ponding	Severe- seasonal high water table	Severe- seasonal high water table, ponding	Severe- seasonal high water table, ponding	Poor-wet
Rains RL	Severe- seasonal high water table, ponding	Severe- seasonal high water table	Severe- seasonal high water table, ponding	Severe- seasonal high water table, ponding	Poor-wet
Seabrook WA	Moderate- seasonal high water table	Severe- percs rapidly	Severe- seasonal high water table, seepage	Severe- seasonal high water table, seepage	Fair-too sandy
Torhunta TP 870	Severe- seasonal high water table, ponding	Severe- seasonal high water table	Severe- seasonal high water table, ponding	Severe- seasonal high water table, ponding	Poor-wet
Wando WA 722	Slight	Severe-percs rapidly	Severe- too sandy, seepage	Severe- seepage	Poor-too sandy
Woodington 833	Severe- seasonal high water table, ponding	Severe- seasonal high water table	Severe- seasonal high water table, ponding	Severe- seasonal high water table, ponding	Poor-wet

Table 12c.

## Interpretations of Engineering Properties of the Soils

## SOURCE MATERIAL

Soil Series and Map Symbols	Degree of Suitability			
	Roadfill	Sand	Gravel	Topsoil
Baymeade 739 BA	Good	Fair-Excess fines	Unsuited	Poor-too sandy
Bibb BJ	Poor-poorly drained	Fair-Excess fines	Unsuited	Fair-poorly drained
Bladen 853	Poor-poorly drained, clayey textured	Unsuited- excess fines	Unsuited	Fair-poorly drained thin layer of loamy soil over clay
Capers CA	Poor-clayey textured	Unsuited	Unsuited	Poor-too clayey, flooded by tides
Corolla CD	Fair-somewhat poorly drained	Good	Unsuited	Poor-too sandy
Craven 558B 558C	Poor-clayey texture	Unsuited- excess fines	Unsuited	Fair-thin layer of loamy soil over clay
Duckston CD	Poor-poorly drained	Good	Unsuited	Poor-too sandy, poorly drained
Johnston BJ	Poor-very poorly drained	Fair-excess fines	Unsuited	Poor-very poorly drained
Kureb KL 704	0-15% slopes: Good, 15-20% slopes: Fair	Good	Unsuited	0-20%: Poor- too sandy
Lakeland KL	0-15% slopes: Good, 15-20% slope: Fair	Good	Unsuited	0-15%: Poor- too sandy
Leon IN 582	Fair-poorly drained	Good	Unsuited	Poor-too sandy, poorly drained
Lynchburg RL	Fair-somewhat poorly drained	Unsuited- excess fines	Unsuited	Good
Lynn Haven LM	Fair-very poorly drained	Good	Unsuited	Poor-too sandy, very poorly drained
Murville IM	Fair-very poorly drained	Fair-excess fines	Unsuited	Poor-very poorly drained
Newhan 708	Good	Good	Unsuited	Poor-too sandy

Table 12c.

## Interpretations of Engineering Properties of the Soils

## SOURCE MATERIAL

Soil Series and Map Symbols	Degree of Suitability			
	Roadfill	Sand	Gravel	Topsoil
Norfolk ON 365C	Good	Unsuited- excess fines	Unsuited	0-8% slopes: Good 8-10%: Fair slopes
Onslow ON 415	Good	Unsuited- excess fines	Unsuited	Good
Pactolus 460	Fair-somewhat poorly drained	Fair-excess fines	Unsuited	Poor-too sandy
Pamlico PM	Poor-wet, excess humus	Unsuited- excess humus and fines	Unsuited	Poor-very poorly drained
Pantego TP	Poor-very poorly drained	Unsuited-excess fines	Unsuited	Poor-very poorly drained
Rains RL	Poor-poorly drained	Unsuited-excess fines	Unsuited	Poor-poorly drained
Seabrook WA	Good	Fair-excess fines	Unsuited	Poor-too sandy
Torhunta TP 870	Poor-very poorly drained	Unsuited-excess fines	Unsuited	Poor-very poorly drained
Wando WA 722	Good	Fair-excess fines	Unsuited	Poor-too sandy
Woodington 833	Poor-poorly drained	Fair-excess fines	Unsuited	Poor-poorly drained

Table 12d. Interpretations of Engineering Properties of the Soils

## WATER MANAGEMENT

Soil Series & Map Symbols	Degree of Limitation			Soil Features Affecting			
	Pond Reservoir Area	Embankments Dikes and Levees	Excavated Ponds Aquifer Fed	Drainage	Irrigation	Terraces and Diversions	Grassed Waterways
Baymeade 739, BA	Severe-seepage	Moderate-piping	Severe-deep to ground water	Not needed	Fast intake, droughty	Too sandy	Droughty
Bibb BJ	Moderate-seepage	Moderate-piping	Slight	Poor outlets, floods, poorly drained	Wet for long periods	Not needed	Poorly drained
Bladen 853	Slight	Moderate-shrink-swell	Slight	Favorable, poorly drained, slow permeability	Wet except in long dry seasons	Not needed	Poorly drained
Capers CA	Slight to Moderate-May have organic layer	Severe-high shrink-swell	Slight	Tidal flooding	Wet	Not needed	Not needed
Corolla CD	Severe-seepage	Severe-piping slope instability, high permeability	Moderate-Deep to ground	Favorable, somewhat poorly drained cut slopes cave	Fast intake, somewhat poorly drained, droughty in dry seasons	Not needed	Not needed
Craven 558B 558C	Slight	Moderate-compressibility	Moderate-Deep to ground water	Favorable on nearly level slopes, moderately well drained, slow permeability	Slow infiltration	Favorable	Favorable
Duckston CD	Severe-seepage	Severe-piping slope instability, high permeability	Slight	Favorable, poorly drained cut slopes cave	Fast intake, poorly drained	Not needed	Not needed
Johnston BJ	Severe-seepage	Severe-piping	Slight	Poor outlets, very poorly drained, floods	Wet for long periods	Not needed	Not needed
Kureb KL 704	Severe-seepage	Severe-piping slope instability, high permeability	Severe-No water	Not needed	Fast intake, droughty	Too sandy	Droughty

Table 12d, Interpretations of Engineering Properties of the Soils

## WATER MANAGEMENT

Soil Series and Map Symbols	Degree of Limitation			Soil Features Affecting			
	Pond Reservoir Area	Embankments Dikes and Levees	Excavated Ponds Aquifer Fed	Drainage	Irrigation	Terraces and Diversions	Grassed Waterways
Lakeland KL	Severe-seepage	Severe-piping, slope instability, high permeability	Severe-no water	Not needed	Fast intake, droughty	Too sandy	Droughty
Leon LN 582	Severe-seepage	Severe-slope instability, high permeability	Moderate-deep to ground water	Favorable-poorly drained cut slopes cave	Fast intake poorly drained	Not needed	Not needed
Lynchburg RL	Moderate-seepage	Slight to moderate-piping	Moderate-deep to ground water	Favorable-somewhat poorly drained	Wet or moist except in long dry seasons	Not needed	Not needed
Lynn Haven LM	Severe-seepage	Severe-slope instability, piping, high permeability	Slight	Poor outlets very poorly drained, cut slopes cave	Wet for long periods, fast intake rate	Not needed	Not needed
Murville LM	Severe-seepage	Severe-piping	Slight	Poor outlets very poorly drained, cut slopes cave	Wet for long periods, fast intake rate	Not needed	Not needed
Newhan 708	Severe-seepage	Severe-piping, slope instability, high permeability	Severe-deep to ground water	Not needed	Fast intake rate, droughty	Not needed	Not needed
Norfolk ON 365C	Moderate-seepage	Slight	Severe-deep to ground water	Not needed	0-6% slopes: favorable—6-10% slopes: unfavorable	0-2% slopes: not needed—2-10% slopes: favorable	Favorable
Onslow ON 415	Moderate-seepage	Slight	Moderate-deep to ground water	Favorable-moderately well drained	Favorable-moderately well drained	Not needed	Not needed

Table 12d. Interpretations of Engineering Properties of the Soils

## WATER MANAGEMENT

Soil Series and Map Symbols	Degree of Limitation			Soil Features Affecting			
	Pond Reservoir Area	Embankments Dikes and Levees	Excavated Ponds Aquifer Fed	Drainage	Irrigation	Terraces and Diversions	Grassed Waterways
Pactolus 460	Severe-seepage	Severe-piping, slope instability, high permeability	Moderate-deep to ground water	Favorable-somewhat poorly drained	Favorable-moist except in dry seasons, fast in take rate droughty in dry seasons	Not needed	Not needed
Pamlico PM	Severe-seepage	Severe-piping, compressibility, high permeability, slope instability	Slight	Ponded run-off, poor outlets	Wet	Not needed	Not needed
Pantego TP	Moderate-seepage	Moderate-piping	Slight	Poor outlets very poorly drained	Wet except in long dry seasons	Not needed	Not needed
Rains RL	Moderate-seepage	Slight to moderate-	Moderate-deep to ground water	Favorable-poorly drained	Wet or moist except in long dry season	Not needed	Not needed
Seabrook WA	Severe-seepage	Severe-piping, slope instability, high permeability	Moderate-deep to ground water	Moderately well drained	Favorable-moderately well drained, droughty in dry seasons, fast intake rate	Not needed	Not needed
Torhunta TP 870	Severe-seepage	Moderate-piping	Slight	Poor outlets cut banks cave	Wet except in long dry seasons	Not needed	Not needed
Wando WA 722	Severe-seepage	Severe-piping slope instability, high permeability	Severe-deep ground water	Not needed	Fast intake rate, droughty	Too sandy	Droughty
Woodington 833	Severe-seepage	Moderate-piping	Moderate-deep to ground water	Favorable-poorly drained	Wet or moist except in long dry seasons	Not needed	Not needed

H.

BIBLIOGRAPHY

- |  |   |
|--|---|
| Tarheel Wildlife on the Farm   | By Charles Woodhouse and Luther Partin July 1972              |
| Lawn Disease How to Control Them   | USDA Home and Garden Bulletin No. 61                          |
| Lawn Insects How to Control Them   | USDA Home and Garden Bulletin No. 53                          |
| Carolina Lawns   | N. C. Agriculture Extension Service Extension<br>Circular 292 |
| Seacoast Plants of the Carolinas for<br>Conservation and Beautification  | By Karl E. Graetz, USDA Soil Conservation Service             |
| Forest Service Handbook  | USDA  |
| Real Property Facilities Manual, Vol V,<br>Management of Natural Resources,<br>Environmental Quality, and Pest Control | USMC, PCN 102 11300500  |



I.

CRITICAL AREA PLANTING

(Permanent Seedings on Graded Development Areas, Etc.)

Where Applicable. Cleared and/or graded areas undergoing development and subject to erosion where grasses and/or legumes are needed to stabilize the soil.

Specifications Guide

The task of considering alternatives, specifying treatment and successfully establishing plant cover on critical areas is a challenging one. For example, planting earlier or later than the optimum date for the species increases the risk of failure and makes the need for mulching or irrigation more acute.

Vegetation cannot be expected to provide erosion control cover and prevent soil slippage on soils that are unstable because of structure, water movement or excessive steepness of slope.

Excessive water run-off must be controlled by establishment of needed water control measures such as desilting basins, diversions, berms, furrows, channel liners, waterways or drainage systems.

A. Table of Plants and Mixtures of Plants for Critical Areas. (See table 13)

B. Site Preparation

1. Grading or clearing of the areas should be done in such a way as to leave the soil in the best possible condition for seeding. This includes leaving as much topsoil as possible or replacing where needed to modify the condition.

2. Grade as needed and feasible to permit the use of conventional equipment for seedbed preparation, seeding, mulch application and anchoring and maintenance operations.

3. Where adverse soil conditions require modification, apply at least 3-4 inches of topsoil or similar soil material. The use of topsoil should be considered where the soil texture at the site is sandy clay, silty clay or clay. Ripping prior to the addition of new material is usually needed.

C. Lime and Fertilizer. Where soils are reasonably uniform, lime and fertilize according to soil test. In the absence of a soil test, apply 2 tons finely ground dolomitic limestone per acre (92 pounds per 1,000 square feet) and 500 to 800 pounds of 20% superphosphate or equivalent per acre (12 to 18 pounds per 1,000 square feet). Additional amounts and analysis of fertilizers to use at seeding are:

1. Grasses alone - 800 to 1,000 pounds per acre of 10-10-10, or equivalent (18-23 pounds per 1,000 square feet).

2. Grasses and legumes or legumes alone - 800 to 1,000 pounds per acre of 5-10-10 or equivalent (18-23 pounds per 1,000 square feet).

3. Normally an additional application of 30-50 pounds of nitrogen per acre is needed within three (3) to twelve (12) months to establish grass plantings. Application should be timed to growing cycle of the species being established.

#### D. Seedbed Preparation

1. Work lime and fertilizer into the soil where conventional equipment can be used. Use disk or similar equipment to prepare to depth of 3-4 inches.

2. Lime and fertilizer may be applied with seed mixture when a hydro-seeder is used and where mulch will be applied. As an alternative, the hydro-seeder may be used to apply lime alone or with a nitrogen topdressing after plants have made 2-3 inches of growth.

3. Slopes that are too steep for conventional equipment (2:1 or steeper) should not be disturbed if they are relatively smooth and uniform. These slopes are best seeded with hydro-seeding equipment.

4. Where hydro-seeding equipment is not available for use on steep slopes (2:1 or steeper), scarify the soil surface with a chain harrow, pick chain, grader blades with chisels, hand tools or other equipment that will pit the soil or make trenches approximately 1-2 inches deep, 6-12 inches apart across the slope in which the seed can lodge and germinate.

#### E. Establishment with Seeds

1. Select a plant or mixture from the attached table 13. In making selections, keep in mind the intended land use, site conditions, and maintenance requirements of the plant or plants.

2. Seed specifications or contracts:

a. Specifications shall state the minimum seed purity percentage and minimum germination percentage that is acceptable for the species being used.

b. Seed containing prohibited or restricted noxious weeds may not be accepted.

c. All seed shall be labeled to show that it meets the requirements of North Carolina seed law.

d. All seed used shall have been tested within the six (6) months immediately preceding the date of seeding.

e. The inoculant for treating legume seed shall be prepared specifically for the species. Inoculants shall not be used later than the date indicated on the container. Twice the supplier's recommended rate of inoculant will be used on dry seedings; four times the recommended rate, if hydro-seeded.

3. Seed should be applied uniformly with cultipacker seeder where possible. Any equipment that will apply seed uniformly is acceptable. Cover seed from  $\frac{1}{2}$  inch to 1 inch deep depending on the size of the seed and firm the soil except where a hydro-seeder is used.

## F. Establishment with Vegetative Material

Areas that will be subject to traffic and routine mowing in residential, commercial or industrial developments may be established by using grass stolons (sprigs or runners). Precaution should be used to make certain only fresh, moist planting material is used.

### Planting Methods for Grass Stolons:

1. Prepare a smooth seedbed, shred stolons, broadcast and press or disk into the top 1-2 inches of soil and firm the soil. Plantings may be made with a transplanter or hand planting tools.
2. Open shallow furrow 24-30 inches apart, drop clumps of stolons in furrow and cover 1-2 inches deep and smooth and firm the soil.
3. Fill burlap bags with grass roots and soil. Place bags 10-15 feet apart in small gullies or scouring ditches.
4. Spread 3-4 inches of soil filled with grass roots and firm the soil.

G. Mulching. Mulch is essential on most critical areas. On moderately fertile to fertile sites planted at optimum time for the species, mulch may be omitted.

### 1. Mulching Materials

a. Dry, unchopped, unweathered small grain straw or hay free of seeds of competing plants - Spread at the rate of 1-2 tons per acre depending upon the site and season. Evenly spread mulch over the area by hand or blower-type spreading equipment. Apply mulch uniformly so that about 25% of the ground surface is visible.

b. Sericea Lespedeza seed bearing stems at a rate of three tons per acre - This mulch may be applied green or dry but must contain mature seed. Liming, fertilizing and land preparation should precede application of the Sericea mulch.

c. Broomsedge hay mulch - Spread where it is desirable to establish this native plant.

d. Wood chips, bark, peanut hulls, and similar plant residues - Spread so as not to present emergence of seedlings on areas that are not subject to concentrations of water. These materials are better suited for mulching woody plantings than broadcast seedings. Depths of more than 1 inch will affect seedling emergence.

e. Local materials such as burlap, tobacco plant bed metting, and pine boughs - Cover entire area; secure in place if flowing water is involved. Do not use green pine branches where pine trees are to be planted because of possible insect or disease injury to plantings.

f. Barnyard manure and bedding - Apply uniformly so that about 25% of the ground surface is visible.

g. Jute matting is a coarse, open-mesh material woven of heavy jute twine. It may be used in place of mulch or sod and has the strength to withstand waterflow. It is an accepted

practice to sow half the seed before placing the matting. Sow the remaining half after the matting is laid. See the manufacturer's specifications for installing.

h. Wood fiber (excelsior) is available as mulch material to be blown on after seeding or as a matting to be stapled on steep slopes, waterways, etc. See the manufacturer's specifications for installing.

i. Wood cellulose fiber mulch is mixed with seed, fertilizer and water. The resulting slurry is sprayed on with hydraulic seeding equipment. Use at the rate of 500 pounds per acre where straw or hay is to be applied. Use at the rate of 1,000 to 1,500 pounds per acre without other mulching materials. Applied in a slurry, wood cellulose fiber mulch is self-anchoring.

j. Other commercial products, as fiberglass and various kinds of nettings, are available. Manufacturer's directions should be followed for applying and securing in place.

2. Mulch Anchoring Methods. Anchor mulch immediately after placement to minimize loss by wind and water. Consider size of area, type of site, and cost and select one of the following:

a. Mulch anchoring tool with a series of flat notched disks that punch and anchor mulch material into the soil. A regular farm disk weighted and set nearly straight may substitute but will not be sharp enough to cut up the mulch. The soil should be moist, free of stones or roots and loose enough to permit penetration to a depth of 3 inches. Operate as near as practical to the contour.

b. Mulch netting - Staple light weight paper, jute, cotton, plastic or wire nettings to the soil surface according to manufacturer's specifications. These nettings are usually in rolls 3 to 4 feet wide and up to 300 feet long.

c. Peg and twine - Drive 8 to 10 inch wooden pegs to within 2 to 3 inches of the soil surface every 4 feet in all directions. Stakes may be driven before or after applying mulch. Secure mulch to soil surface by stretching twine between pegs in a criss-cross within a square pattern. Secure twine around each peg with two or more round turns. Poles and stakes may be used to secure brush in place.

d. Pick chain - This rolling spiked-chain implement can be operated on slopes of 3:1 gradient or steeper. It is attached to a tractor or truck which operates along the top of the slope. The pick chain can also be used for seedbed preparation and mixing lime and fertilizer with the soil.

e. Slit - With a square pointed spade, cut mulch into the surface soil in contour rows 18 inches apart.

f. Asphalt mulch tie-down - Asphalt sprayed uniformly on the mulch as it is ejected from the blower is more effective than applied as a separate operation. Rates of application will vary with conditions. Apply so area has uniform appearance.

(1) Emulsified asphalt - Apply uniformly 0.04 gallons per square yard or 200 gallons per acre of emulsified asphalt. Emulsified asphalt should not be used in freezing weather since it contains approximately 50% water.

(2) Liquid asphalt - May be applied at any time of the year since it is thinned with a kerosene-like product. Uniformly apply 0.10 gallons per square yard or 500 gallons per acre. See the manufacturer's specifications.

NOTE: In areas of playing children or pedestrian traffic, asphalt methods could cause problems of "tracking in" on rugs, damaging shoes, clothing, etc.

g. Mulch can be anchored with rye for fall plantings or millet for summer plantings. Use  $\frac{1}{4}$  to  $\frac{1}{2}$  bushel of rye or 15 pounds of millet per acre broadcast ahead of mulch application.

H. Maintenance. Maintenance is the most important controllable factor in retaining an effective vegetative cover.

1. Control of Competition. Competitive weed growth during the period of establishment should be controlled by mowing and/or with herbicides. When chemicals are used, follow current North Carolina Agricultural Experiment Station's chemical weed control recommendations and adhere strictly to instructions on label.

2. Irrigation. If soil moisture is deficient, supply new plantings with adequate water (3"-4" penetration) for plant growth at 10-day intervals, if needed, until they are established. This is most important on late season plantings, in abnormally dry or hot seasons.

3. Repairs. Inspect all areas for planting failures and make necessary repairs, replacements and reseeded within the planting season if possible.

4. Lime and Fertilizer. Lime and fertilizer should be applied under a regular program based on soil fertility tests and on the use and general appearance of the vegetative cover. In the absence of a soil test, lime and fertilize as shown below:

a. Apply 1 to 2 tons ground dolomitic limestone per acre, or 43-92 pounds per 1,000 square feet during late fall or winter every 3-4 years and fertilize annually or as needed to maintain healthy vigorous growing plants.

b. Pure stands of Tall Fescue and similar cool season plants. Apply 400-500 pounds per acre or 9-12 pounds per 1,000 square feet of 10-10-10, or its equivalent in early fall. Additional fertilization with nitrogen or a complete fertilizer is usually needed in early spring.

c. Pure stands of Bermuda, Bahia, Lovegrass and similar warm season grasses. Apply 400-500 pounds per acre of 9-12 pounds per 1,000 square feet of 10-10-10 fertilizer or equivalent when the plants start to green up in the spring. Topdress with 60-90 pounds of nitrogen per acre or 1-2 pounds per 1,000 square feet, during the growing season. When the higher rate is used, apply in split applications.

d. Pure stands of Sericea Lespedeza and similar legumes. Fertilize in early spring with 400-500 pounds of 0-10-20 (9-12 pounds per 1,000 square feet) or equivalent per acre.

e. Mixtures of Sericea Lespedeza, Fescue, Lovegrass or Bermudagrass. Fertilize in late winter or early spring with 400-500 pounds per acre (9-12 pounds for 1,000 square feet) or

5-10-10 or equivalent. In Fescue-Sericea Lespedeza mixture, apply in the fall if the Sericea Lespedeza is developing better than the Fescue.

f. Fescue-White Clover and similar mixtures. Apply 400-500 pounds per acre (9-12 pounds per 1,000 square feet) of 0-20-20 or equivalent in early fall. An additional application of nitrogen or complete fertilizer may be needed in the spring to keep plants lush and in balance. Where grass is crowding out the clover, reduce or eliminate spring application of nitrogen.

5. Mowing

a. Mow Sericea Lespedeza or Sericea Lespedeza and grass mixtures only after a killing frost. Fall Fescue should not be mowed closer than 3-4 inches.

b. Care should be taken not to damage the vegetation mechanically through use of improper mowing equipment or be attempting to mow with heavy equipment on steep slopes when the vegetation is lush and slippery or when the ground is soft enough to be rutted by mower or tractor wheels.

c. Where mowing fails to control weeds satisfactorily, apply chemicals in accordance with current North Carolina Agricultural Experiment Station's weed control recommendations and adhere strictly to instructions on label.

Caution: Pesticides are dangerous. Use only as directed and heed all precautions on the contained label. Check the registration number and be sure that the directions for use include the target pests. Drift from aerial spraying can contaminate nearby crops and forage, lakes and reservoirs. Improper use and careless disposal of unused portions can lead to poisoning of humans, domestic animals, desirable plants, pollinating insects, fish and wildlife and can contaminate water supplies.

Table 13. Plants and Mixtures of Plants for Critical Areas

PLANTS AND MIXTURES	PLANTING RATES/ACRE	PLANTING DATES	NOTES
1. Pensacola Bahiagrass	30-40 lbs	Mar 15-Jun 15	
2. Wilmington Bahiagrass	30-40 lbs	Mar 15-Jun 15	
3. Common Bermudagrass (hulled)	8-12 lbs	April-July	
4. Common Bermudagrass (unhulled)	15-20 lbs	Jan-March	
5. Common or Tufcote Bermudagrass sprigs	Sprigs 2'x2' 30 cu ft or Broadcast 50-80 cu ft	Mar-Apr 15	Tiflawn lower-growing & finer turf than common. Requires sunny sites.
6. Tiflawn Bermudagrass sprigs	Sprigs 2'x2' 30 cu ft or Broadcast 40-60 cu ft	Mar-Apr 15	
7. Coastal Bermudagrass sprigs	Sprigs 2'x2' 30 cu ft or Broadcast 50-80 cu ft	Mar-Apr 15	Suited to well-drained sites, requires high level of management.
8. Kudzu (plants)	Space 4'x5' 2,200 plants	Late winter/ early spring	Well adapted to large & very steep cuts & high fills—not suited to soils with poor internal drainage. Excellent for gullies.
9. Weeping Lovegrass	4-5 lbs	Mar 15-June	Gives quick summer cover—well adapted to droughty sites. Best in mixture with Sericea Lespedeza—tends to become clumpy with age.
10. Maiden cane (plants)	Space 2'x2' 11,000 plants dig native plants	Late winter/ spring	Good on stream & canal banks, not for small laterals & small stream channels with low velocity.
11. Sericea Lespedeza (scarified)	40-50 lbs	March-May	Avoid wet sites—will persist & furnish cover on eroded droughty sites & subsoil material.
12. Sericea Lespedeza (unscarified)	50-60 lbs	Oct-Feb	Tolerates low level of management. May be seeded alone or overseeded on Fescue, Lovegrass, small-grain & other compatible plants during fall & winter months
13. Sericea Lespedeza (scarified) and Pensacola Bahiagrass	25-35 lbs 20-30 lbs	March-May	Tolerates low level of management.

PIANTS AND MIXTURES	PLANTING RATES/ACRE	PLANTING DATES	NOTES
14. Sericea Lespedeza (scarified) and Wilmington Bahiagrass	25-35 lbs 20-30 lbs	March-May	Tolerates low level of management.
15. Sericea Lespedeza (scarified) and Weeping Lovegrass	40-50 lbs 4-5 lbs	March-May	Lovegrass provides quick protective cover
16. Sericea Lespedeza (scarified) and Common Bermudagrass (hulled)	40-50 lbs 6-8 lbs	March-May	Bermuda provides quick land cover, spreads & heals in open areas. Bermudagrass usually disappears where Sericea establishes a canopy.
17. Sericea Lespedeza (scarified) and Tall Fescue	40-50 lbs 25-30 lbs	March-April	Scarified Sericea may be spring seeded on Fescue seeded the previous fall
18. Sericea Lespedeza (unscarified) and Tall Fescue	50-60 lbs 25-30 lbs	Sep-Nov	If Sericea seed is unavailable at planting time, it may be overseeded on Fescue later in the winter.
19. Tall Fescue	40-60 lbs	Sep-Nov	Not well suited to infertile, droughty, sandy soils. Requires good maintenance.
20. Tall Fescue and White Clover	30-50 lbs 3-4 lbs	Sep-Nov	Can be used where mowing is desired & high level of maintenance will be provided
21. Tall Fescue and Browntop Millet or Sorghum-Sudan Hybrids	40-60 lbs 25-35 lbs 25-30 lbs	Aug-Sep	Keep annuals cut back to 10-12 inches. Mulching is desirable.
22. Tall Fescue and Rye	40-60 lbs 25-30 lbs	Dec-Jan	Use only when necessary to complete a job. Mulching will be necessary to provide erosion control. Keep annuals cut back to 10-12 inches.

There will be conditions and interest that will warrant the use of other plants or mixtures not listed in the above table. Their use should be evaluated for each site.

Some rules of thumb for conversions:

Lbs/Ac x .367	= Oz/1,000 sq ft
Lbs/Ac x .0023	= Lbs/100 sq ft
Lbs/Ac x .023	= Lbs/1,000 sq ft
Lbs/Ac x .000207	= Lbs/100 sq ft
Lbs/Ac x .207	= Lbs/1,000 sq yds
Sq ft of area x .000023	= Acres (valid up to 10 acres)
Lbs/Ac x .0207	= Lbs/100 sq yds



J.

CRITICAL AREA PLANTING

(Permanent Seeding on Dams, Mine Spoils, Demuded or Gullied Areas, Etc.)

Where Applicable. On sediment producing, highly erodible or severely eroded areas, such as gullies, dams, spillways, borrow areas, mine spoils, road cuts, fills, shoulders and other areas where vegetation is difficult to establish with normal seeding or planting methods.

Specifications Guide

A. Table of Plants and Mixtures of Plants for Critical Areas (See attached table 14)

B. Grading or Shaping

1. Divert concentrations of surface water where safe outlets can be provided.
2. Locate roads on the countour and provide adequate road ditch capacity for safe disposal of run-off where practical.
3. Slope the areas to be seeded to a 3:1 ratio slope or flatter if conventional equipment (as farm-type tractors, harrows, mowing machine) is to be used in seeding or maintenance.
4. Grading and shaping is desirable but not necessary when seeding is done by other than conventional means, such as with hydro-seeding equipment or hand methods.
5. Remove all loose rock, woody material and other obstructions from the surface that will interfere with the establishment and maintenance of vegetation.

C. Lime and Fertilizer for Establishment. Where soils are reasonably uniform, lime and fertilize according to soil test. In the absence of a soil test, apply 2 tons of finely ground dolomitic limestone and 500 to 800 pounds of 20% superphosphate or equivalent per acre. Additional amounts and analysis of fertilizers to use at seeding are:

1. Grasses alone - 800-1,000 pounds of 10-10-10 or equivalent per acre.
2. Grasses and Legumes or Legumes alone - 800-1,000 pounds of 5-10-10 or equivalent per acre.

Apply lime and fertilizer uniformly prior to seedbed preparation and mix with the soil when site is prepared with conventional equipment. Mix lime and fertilizer with the soil used to fill excavated "pot" holes. It should be evenly distributed when applied in furrows. On slopes steeper than 2:1, apply lime and fertilizer after soil scarification is done.

3. Normally an additional application of 30-50 pounds of nitrogen per acre is needed within three (3) to twelve (12) months to establish grass plantings. Application should be timed to growing cycle of the species being established.

D. Seedbed or Site Preparation

1. On slopes too steep for conventional equipment, scarify surface with a chain harrow, grader blades, chisels, hand tools or other equipment that will pit the soil or make small trenches approximately 1 to 2 inches apart across the slope in which seed can lodge and germinate.

2. On all sites where conventional equipment is used, prepare seedbeds to a depth of 3-4 inches.

3. Pre-treatment of gullies, abandoned mines or similar site conditions:

a. Where practical and feasible - slope banks and construct diversions to facilitate establishment of vegetation. Provide temporary cover with annual plants or mulch area if permanent planting is to be delayed.

b. Where impractical to slope banks - divert concentration of surface water into safe outlets, preserve existing native vegetation, construct brush, rock or similar dams on the floor of the gully, plant a 20-foot wide strip of vegetation, such as Kudzu, Sericea Lespedeza, Weeping Lovegrass, or other adapted perennial around the outside rim of the gully or abandoned mine; or plant the entire area to adapt trees and grasses and/or legumes.

c. Also see Critical Area Planting - With Shrubs, Vines, Trees and other Plants and With Short Term Seeding.

4. Site preparation is not necessary where hydro-seeding equipment is used.

#### E. Establishment With Seeds

1. From the attached table, select the best suited plant or mixture that is hardy and capable of withstanding abuse and will prevent erosion under adverse conditions for a long time.

2. Seed specifications on contracts:

a. Specifications shall state the minimum seed purity percentage and minimum germination percentage that is acceptable for the species being used.

b. Seed containing prohibited or restricted noxious weeds may not be accepted.

c. All seed shall be labeled to show that it meets the requirements of North Carolina Seed Law.

d. All seed used shall have been tested within the six (6) months immediately preceding the date of seeding.

e. The inoculant for treating legume seed shall be prepared specifically for the species. Inoculants shall not be used later than the date indicated on the container. Twice the supplier's recommended rate of inoculant will be used on dry seedings; four times the recommended rate if hydro-seeded.

3. Where hydraulic seeding equipment is used, seed, fertilizer, and wood-fiber mulch materials are mixed into a slurry with water. Care should be used to spread the mixture evenly and soon after the mixture is made. Keep the mixture well agitated when seeding.

4. Where conventional equipment is used, seed shall be applied uniformly with cultipacker-seeders, drills, rotary seeders or other mechanical seeders. Any equipment that will apply seed uniformly is acceptable. Seedings may be done by hand on areas where it is not practical and feasible to use equipment. When seeding by hand, sow one-half in one direction and the other half at right angles to the first. Cover seed to a depth of approximately  $\frac{1}{2}$  to 1 inch, depending on the size of the seed. When cultipacker-seeder is not used, firm seedbed and cover with cultipacker or similar equipment before or after mulching, depending upon type mulch used and method of anchoring mulch that is used.

#### F. Establishment with Vegetative Material

1. Select a suitable plant from the attached table.

2. Apply lime and fertilizer and prepare land as for permanent seedings.

3. Bermudagrass planting methods:

a. Broadcast and press or disk sprigs into the top 1-2 inches of soil or plant sprigs in shallow furrows and cover about 1 to 2 inches deep; or use transplanter or plant sprigs by hand with spade, dibble or similar hand tools. Firm the soil around the sprigs with cultipacker, roller, or some other means.

b. Fill burlap bags with Bermudagrass roots and soil. Place bags 10-15 feet apart in gullies or ditches.

c. Spread 3 to 4 inches of soil filled with Bermudagrass roots and firm the soil.

4. Kudzu, Maiden Cane and similar plants may be planted in furrows, excavated holes or with spade, dibble or similar hand tools. When planting in excavated holes, dig holes large enough to allow roots to spread out to full length. When planting in "pot" holes or furrows, place about a level tablespoon of fertilizer per plant in the bottom of the hole or furrow and cover with fresh soil before planting. Set plants slightly deeper than they grew in the nursery and firm the soil. If vegetative materials are not dormant, water during planting operations.

G. Mulching. Mulch is essential on steep erosive sites where plant establishment may be expected to be difficult.

1. Mulching Materials

Dry, unchopped, unweathered small grain straw, pine straw, or hay free of seeds of competing plants - Spread at the rate of 1 to 2 tons per acre, depending upon the site and season. Evenly spread mulch over the area by hand or blower-type spreading equipment. Apply mulch uniformly so that about 25% of the ground surface is visible.

b. Sericea Lespedeza seed bearing stems at a rate of three tons per acre - This mulch may be applied green or dry but must contain mature seed. Liming, fertilizing and land preparation should precede application of the Sericea mulch.

c. Broomsedge hay mulch - Spread where it is desirable to establish this native plant.

d. Wood chips, bark, peanut hulls and similar plant residues - Spread so as not to prevent emergence of seedlings on areas that are not subject to concentrations of water. These materials are better suited for mulching woody plantings than broadcast seedings. Depths of more than 1 inch will affect seedling emergence.

e. Local materials such as burlap, tobacco plant bed netting and pine boughs - Cover entire area; secure in place if flowing water is involved. Do not use green pine branches where pine trees are to be planted because of possible insect or disease injury to plants.

f. Jute matting is a coarse, open mesh material woven of heavy jute twine. It may be used in the place of mulch or sod and has the strength to withstand water flow. It is an accepted practice to sow half the seed before placing the matting. Sow the remaining half after the matting is laid. See the manufacturer's specifications for installing.

g. Wood fiber (excelsior) is available as mulch material to be blown on after seeding or as a matting to be stapled on steep slopes, waterways, etc. See the manufacturer's specifications for installing.

h. Wood cellulose fiber mulch is mixed with seed, fertilizer and water. The resulting slurry is sprayed on with hydraulic seeding equipment. Use at the rate of 500 pounds per acre where straw or hay is to be applied. Use at the rate of 1,000 to 1,500 pounds per acre without other mulching materials. Applied in a slurry, wood cellulose fiber mulch is self-anchoring.

2. Mulch Anchoring Methods. Anchor mulch immediately after placement to minimize loss by wind and water. Consider size of area, type of site, and cost and select from the following methods of anchoring:

a. Mulch anchoring tool with a series of flat notched disks that punch and anchor mulch material into the soil. A regular farm disk weighted and set nearly straight may substitute but will not do a job comparable to the mulch anchoring tool. The disk should not be sharp enough to cut up the mulch. The soil should be moist, free of roots and loose enough to permit penetration to a depth of 3 inches. Operate as near as practical to the contour.

b. Mulch nettings - Staple light weight paper, jute, cotton, plastic or wire nettings to the soil surface according to manufacturer's specifications. These nettings are usually in rolls 3 to 4 feet wide and up to 300 feet long.

c. Peg and twine - Drive 8 to 10 inch wooden pegs to within 2 to 3 inches of the soil surface every 4 feet in all directions. Stakes may be driven before or after applying mulch. Secure mulch to soil surface by stretching twine between pegs in a criss-cross within a square pattern. Secure twine around each peg with two or more round turns. Poles and stakes may also be used to secure brush in place.

d. Pick chain - This rolling spiked-chain implement can be operated on slopes of 3:1 gradient or steeper. It is attached to a tractor or truck which operates along the top of the slope. The pick chain can also be used for seedbed preparation and mixing lime and fertilizer with the soil.

e. Slit - With a square pointed spade, cut mulch into the surface soil in contour rows 18 inches apart.

f. Asphalt mulch tie-down - Asphalt sprayed uniformly on the mulch as it is ejected from the blower is more effective than applied as a separate operation. Rates of application will vary with conditions. Apply so area has uniform appearance.

(1) Emulsified asphalt - Apply uniformly 0.04 gallons per square yard or 200 gallons per acre. See the manufacturer's specifications. Emulsified asphalt should not be used in freezing weather since it contains approximately 50% water.

(2) Liquid asphalt - May be applied at any time of the year since it is thinned with a kerosene-like product. Uniformly apply 0.10 gallons per square yard or 500 gallons per acre. See the manufacturer's specification.

NOTE: In areas of playing children or pedestrian traffic, asphalt methods could cause problems of "tracking in" on rugs, damaging shoes, clothing, etc.

g. Mulch can be anchored with rye for fall plantings or millet for summer plantings. Use  $\frac{1}{2}$  bushel of rye or 15 pounds of millet per acre broadcast ahead of mulch application.

H. Maintenance. Maintenance is the most important controllable factor in retaining an effective vegetative cover.

1. Control of Competition. Competitive weed growth during the period of establishment should be controlled by mowing and/or with herbicides. When chemicals are used, follow N. C. Agricultural Experiment Station's chemical weed control recommendations and adhere strictly to instructions on the label.

2. Irrigation. If soil moisture is deficient, supply new plantings with adequate water (3"-4" penetration) for plant growth at 10-day intervals, if needed, until they are established. This is most important on late season plantings and in abnormally dry or hot seasons.

3. Repairs. Inspect all areas for planting failures and make necessary repairs, replacements and reseeding within the planting season if possible.

4. Maintenance Fertilization. Lime and fertilizer should be applied under a regular program based on soil fertility tests and on the general appearance of the vegetative cover. In the absence of a soil test, apply 1-2 tons of finely ground dolomitic limestone per acre every 4 or 5 years. Fertilize as needed to maintain healthy, vigorous growing plants with the following fertilizer materials:

		PO	KO
<u>Species</u>	<u>N</u>	<u>25</u>	<u>2</u>
Grasses and Legumes	60	60	60
	80	40	40
	0	60	60

5. Mowing. Mow Sericea or Sericea-grass mixtures only after a killing frost. Tall Fescue should be mowed not closer than 3-4 inches. Bahia and low-growing Bermudagrass may be mowed about 2 inches high. Care should be taken not to damage vegetation mechanically through use of improper mowing equipment or by attempting to mow with heavy equipment on steep slopes when the vegetation is lush and slippery or when the ground is soft enough to be rutted by mower or tractor wheels. Where mowing fails to control weeds satisfactorily, apply chemicals in accordance with current N. C. Agricultural Experiment Station Weed Control recommendations and adhere strictly to instructions on label.

Caution: Pesticides are dangerous. Use only as directed and heed all precautions on the container label. Check the registration number and be sure that the directions for use include the target pests. Drift from aerial spraying can contaminate nearby crops and forage, lakes, and reservoirs. Improper use and careless disposal of unused portions or containers can lead to poisoning of humans, domestic animals, desirable plants, pollinating insects, fish and wildlife and can contaminate water supplies.

Table 14. Plants and Mixtures of Plants for Critical Areas

PLANTS AND MIXTURES	PLANTING RATES/ACRE	PLANTING DATES	NOTES
1. Pensacola Bahiagrass	30-40 lbs	Mar 15-Jun 15	
2. Wilmington Bahiagrass	30-40 lbs	Mar 15-Jun 15	
3. Common Bermudagrass (hulled)	8-12 lbs	April-Jul	
4. Common Bermudagrass (unhulled)	15-20 lbs	Jan-March	
5. Common or Tufcote Bermudagrass sprigs	Sprigs 2'x2' 30 cu ft or Broadcast 50-80 cu ft	Mar-Apr 15	Tiflawn lower-growing and finer turf than common. Requires sunny sites.
6. Tiflawn Bermudagrass sprigs	Sprigs 2'x2' 30 cu ft or Broadcast 40-60 cu ft	Mar-Apr 15	
7. Coastal Bermudagrass sprigs	Sprigs 2'x2' 30 cu ft or Broadcast 50-80 cu ft	Mar-Apr 15	Suited to well-drained sites. Requires high level of management.
8. Kudzu (plants)	Space 4'x5' 2,200 plants	1. Late winter/ early spring	Well adapted to large & very steep cuts & high fills—not suited to soils with poor internal drainage—excellent for gullies
9. Weeping Lovegrass	4-5 lbs	Mar 15-June	Gives quick summer cover—well adapted to droughty sites—Best in mixtures with Sericea Lespedeza—tends to become clumpy with age.
10. Maiden cane (plants)	Space 2'x2' 11,000 plants dig native plants	Late winter/ spring	Adapted to all of the Coastal Plain & southeastern half of Piedmont. Good on stream & canal banks, not for small laterals & small channels with low velocity.
11. Sericea Lespedeza (scarified)	40-50 lbs	March-May	Avoid wet sites—will persist & furnish cover on eroded droughty sites & subsoil material.
12. Sericea Lespedeza (unscarified)	50-60 lbs	Oct-Feb	Tolerates low level of management. May be seeded alone or overseeded on Fescue, Lovegrass, smallgrain & other compatible plants during the fall & winter months
13. Sericea Lespedeza (scarified) and Pensacola Bahiagrass	25-35 lbs 20-30 lbs	March-May	Tolerates low level of management.

PLANTS AND MIXTURES	PLANTING RATES/ACRE	PLANTING DATES	NOTES
14. Sericea Lespedeza (scarified) and Wilmington Bahiagrass	25-35 lbs 20-30 lbs	March-May	
15. Sericea Lespedeza (scarified) and Weeping Lovegrass	40-50 lbs 4-5 lbs	March-May	Lovegrass provides quick protective cover
16. Sericea Lespedeza (scarified) and Common Bermudagrass (hulled)	40-50 lbs 6-8 lbs	March-May	Bermuda provides quick land cover, spreads & heals in open areas. Bermudagrass usually disappears where Sericea establishes a canopy.
17. Sericea Lespedeza (scarified) and Tall fescue	40-50 lbs 25-30 lbs	March-April	Scarified Sericea may be spring seeded on Fescue seeded the previous fall
18. Sericea Lespedeza (unscarified) and Tall Fescue	5-60 lbs 25-30 lbs	Sep-Nov	If Sericea seed unavailable at planting time, it may be overseeded on Fescue later in the winter.
19. Tall Fescue	40-60 lbs	Sep-Nov	Not well suited to infertile, droughty, sandy soils. Requires good maintenance.
20. Tall Fescue and White Clover	30-50 lbs 3-4 lbs	Sep-Nov	Can be used where regular mowing is desired & high level of maintenance will be provided.
21. Tall Fescue and Browntop Millet or Sorghum-Sudan Hybrids	40-60 lbs 25-35 lbs 25-30 lbs	Aug-Sep	Keep annuals cut back to 10-12 inches. Mulching is desirable.
22. Tall Fescue and Rye	40-60 lbs 25-30 lbs	Dec-Jan	Use only when necessary to complete a job. Mulching will be necessary to provide erosion control. Keep annuals cut back to 10-12 inches.

There will be conditions and interest that will warrant the use of other plants or mixtures not listed in the above table. Their use should be evaluated for each site.

Some rules of thumb for conversions:

Lbs/Ac x .367	= Oz/1,000 sq ft
Lbs/Ac x .0023	= Lbs/100 sq ft
Lbs/Ac x .023	= Lbs/1,000 sq ft
Lbs/Ac x .000207	= Lbs/sq yd
Lbs/Ac x .0207	= Lbs/100 sq yds
Lbs/Ac x .207	= Lbs/1,000 sq yds
Sq ft of area x .000023	= Acres (valid up to 10 acres)



K.

CRITICAL AREA PLANTING

(Permanent Seeding on Dikes, Ditch Banks, Etc.)

Where Applicable. On dikes, berms or along ditches that are newly constructed or being improved by shaping the old banks.

Specifications Guide

A. Table of Plants and Mixtures of Plants for Critical Areas. (See attached table 14.)

B. Site Preparation

1. Where practical and feasible, shape all areas to be seeded to permit the use of conventional equipment in the establishment and maintenance of vegetation.

2. Where ditch side slopes are to be seeded and maintained with conventional equipment, slope the banks to a 3:1 ratio or flatter.

3. Smoothing the soil is desirable, but not necessary when seeding with hydraulic equipment or by hand.

4. No seedbed preparation is necessary on most soil and site conditions where seeding is done immediately after excavation or soil spreading is completed. Where this type of seeding is done, the excavation work should be completed during the optimum seeding date for the desired plant or mixture of plants.

5. Remove all woody material, loose rock and other obstructions that may interfere with planned seeding and maintenance operations.

C. Lime and Fertilizer

1. Where soils are seasonably uniform, lime and fertilize according to soil test recommendations. In the absence of a soil test, apply 2 tons lime per acre and fertilize with the amounts and analysis shown below. Lime and fertilizer shall be spread uniformly over the area to be planted.

a. Grasses alone: 800 to 1,000 pounds of 10-10-10 or equivalent per acre.

b. Mixtures of grasses and legumes or legumes alone: 800 to 1,000 pounds of 5-10-10 or equivalent per acre.

c. Normally an additional application of nitrogen or complete fertilizer is needed within three (3) to twelve (12) months to establish critical area plantings. Application should be timed to growing cycle of the species being established.

2. Where possible, mix lime and fertilizer into the soil by disking or harrowing to a depth of approximately 3 inches. Otherwise, broadcast on soil surface or apply with hydraulic seeding equipment.

D. Selecting Plants

1. Tress and shrubs are not covered in these specifications. They may be used where they are compatible with the engineering design.

2. Guide to selecting plants from Table 14.

a. Consider site conditions, time of planting and maintenance requirements.

b. Plants for droughty sites - Bahiagrass, Sericea Lespedeza and Weeping Lovegrass.

c. Plants for wet sites - Tall Fescue and Maiden Cane.

d. Plants for variable or mixed soil conditions - One of the plants named above or Kudzu or Bermudagrass may be adapted. A mixture of plants will usually be more practical than a single plant to provide cover on these sites.

e. Seeding of annuals or a mixture of annuals and perennials may be justified for sediment reduction when bare soil is exposed during the off season for seeding the desired perennial alone.

f. Maintenance - Kudzu and Sericea Lespedeza maintain land cover with a lower level of maintenance than the grasses.

E. Seeding

1. Seed with a grain drill or cultipacker-type seeder when possible or broadcast seed with a cyclone or similar type seeder. Cover seed with a cultipacker or other suitable device on all areas where equipment can be used.

2. Furrowing or pitting the side slopes will help hold fertilizer and seed in place on areas where equipment cannot be used.

3. Seeding may be made by broadcasting the seed on soil areas and side slopes immediately following excavation or soil spreading.

4. Seed specifications on contracts

a. Specifications shall state the minimum seed purity percent and minimum germination percent that is acceptable for the species being used.

b. Seed containing prohibited or restricted noxious weeds should not be accepted.

c. All seed shall be labeled to show that it meets the requirements of the North Carolina Seed Law.

d. All seed used shall have been tested within the six (6) months immediately preceding the date of seeding.

e. The inoculant for treating legume seed shall be prepared specifically for the species. Inoculants shall not be used later than the date indicated on the container. Twice the supplier's recommended rate if hydro-seeded.

F. Establishment with Vegetative Material

1. Table 14 shows the kind of plants, planting material and spacing to be used.

2. Bermudagrass stolons may be: broadcast and pressed or disked into the top 1-2 inches of soil and firmed; dropped in shallow furrows, covered about 1-2 inches deep and firmed; planted with a transplanter; or by opening holes with hand planting tools.

3. Kudzu, Maiden Cane and similar plants are planted in furrows, excavated holes or by opening holes with planting irons. Plants should be set slightly deeper than they grew in the nursery.

G. Mulching. Mulch is essential on steep erosive sites where plant establishment may be expected to be difficult.

1. Mulching Materials

a. Dry, unchopped, unweathered small grain straw or hay free of seeds of competing plants - Spread at the rate of 1-2 tons per acre depending upon the site and season. Evenly spread mulch over the area by hand or blower-type spreading equipment. Apply mulch uniformly so that about 25% of the ground surface is visible.

b. Sericea Lespedeza seed bearing stems at a rate of three tons per acre - This mulch may be applied green or dry but must contain mature seed. Liming, fertilizing and land preparation should precede application of the Sericea mulch.

c. Broomsedge hay mulch - Spread where it is desirable to establish this native plant.

d. Wood chips, bark, peanut hulls and similar plant residues - Spread so as not to prevent emergence of seedlings on areas that are not subject to concentrations of water. These materials are better suited for mulching woody plantings than broadcast seedings. Depth of more than 1 inch will affect seedling emergence.

e. Local materials such as burlap, tobacco plant bed netting and pine boughs - Cover entire area; secure in place if flowing water is involved. Do not use green pine branches where pine trees are to be planted because of possible insect or disease injury to plantings.

f. Barnyard manure and bedding - Apply uniformly so that about 25% of the ground surface is visible.

g. Jute matting is a coarse, open-mesh material woven of heavy jute twine. It may be used in place of mulch or sod and has the strength to withstand waterflow. It is an accepted

practice to sow half the seed before placing the matting. Sow the remaining half after the matting is laid. See the manufacturer's specifications for installing.

h. Wood fiber (excelsior) is available as mulch material to be blown on after seeding or as a matting to be stapled on steep slopes, waterways, etc. See the manufacturer's specifications for installing.

i. Wood cellulose fiber mulch is mixed with seed, fertilizer and water. The resulting slurry is sprayed on with hydraulic seeding equipment. Use at the rate of 500 pounds per acre where straw or hay is to be applied. Use at the rate of 1,000 to 1,500 pounds per acre without other mulching materials. Applied in a slurry, wood cellulose fiber mulch is self-anchoring.

j. Other commercial products, as fiberglass and various kinds of nettings, are available. Manufacturer's directions should be followed for applying and securing in place.

2. Mulch Anchoring Methods. Anchor mulch immediately after placement to minimize loss by wind and water. Consider size of area, type to site and cost, and select one of the following:

a. Mulch anchoring tool with a series of flat notched disks that punch and anchor mulch material into the soil. A regular farm disk weighted and set nearly straight may substitute but will not do a job comparable to the mulch anchoring tool. The disk should not be sharp enough to cut up the mulch. The soil should be moist, free of roots and loose enough to permit penetration to a depth of 3 inches. Operate as near as practical to the contour.

b. Mulch nettings - Staple light weight paper, jute, cotton, plastic or wire nettings to the soil surface according to manufacturer's specifications. These nettings are usually in rolls 3 to 4 feet wide and up to 300 feet long.

c. Peg and twine - Drive 8 to 10 inch wooden pegs to within 2 to 3 inches of the soil surface every 4 feet in all directions. Stakes may be driven before or after applying mulch. Secure mulch to soil surface by stretching twine between pegs in a criss-cross within a square pattern. Secure twine around each peg with two or more round turns. Poles and stakes may also be used to secure brush in place.

d. Pick chain - This rolling spiked-chain implement can be operated on slopes of 3:1 gradient or steeper. It is attached to a tractor or truck which operates along the top of the slope. The pick chain can also be used for seedbed preparation and mixing lime and fertilizer with the soil.

e. Slit - With a square pointed spade, cut mulch into the surface soil in contour rows 18 inches apart.

f. Asphalt mulch tie-down - Asphalt sprayed uniformly on the mulch as it is ejected from the blower is more effective than applied as a separate operation. Rates of application will vary with conditions. Apply so area has uniform appearance.

(1) Emulsified asphalt - Apply uniformly 0.04 gallons per square yard or 200 gallons per acre. See the manufacturer's specifications. Emulsified asphalt should not be used in freezing weather since it contains approximately 50% water.

(2) Liquid asphalt - May be applied at any time of the year since it is thinned with a kerosene-like product. Uniformly apply 0.10 gallons per square yard or 500 gallons per acre. See the manufacturer's specifications.

NOTE: In areas of playing children or pedestrian traffic, asphalt methods could cause problems of "tracking in" on rugs, damaging shoes, clothing, etc.

g. Mulch can be anchored with rye for fall plantings or millet for summer plantings. Use  $\frac{1}{4}$  to  $\frac{1}{2}$  bushel of rye or 15 pounds of millet per acre broadcast ahead of mulch applications.

H. Maintenance. Maintenance is the most important controllable factor in retaining an effective vegetative cover.

1. Control of Competition. Competitive weed growth during the period of establishment should be controlled by mowing and/or with herbicides. When chemicals are used, follow current N. C. Agricultural Experiment Station's chemical weed control recommendations and adhere strictly to instructions on the label.

2. Irrigation. If the soil moisture is deficient, supply new plantings with adequate water (3"-4" penetration) for plant growth at 10-day intervals, if needed, until they are established. This is most important on late season plantings and in abnormally dry or hot seasons.

3. Repairs. Inspect all areas for planting failures and make necessary repairs, replacements and reseeded within the planting season, if possible.

4. Fertilization. Lime and fertilizer to maintain effective land cover should be applied under a regular program based on soil tests and the use and general appearance of the vegetative cover. In the absence of a soil test, lime and fertilize as follows:

a. Lime. Apply 1 to 2 tons of ground dolomitic limestone per acre during late fall or winter every 4 to 5 years.

b. Fertilizer

(1) Cool season grasses - Every 2 years apply 400-500 pounds of 10-10-10 fertilizer per acre in the fall and 30-50 pounds of nitrogen annually, if needed, in the early spring.

(2) Warm season grasses - Every 2 years apply 400-500 pounds of 10-10-10 fertilizer per acre in February or March. Follow with 30-50 pounds of nitrogen annually, if needed, per acre in June or July.

(3) Sericea lespedeza and similar legumes - Every 3-4 years apply 400-500 pounds of 0-10-20 fertilizer per acre in February or March.

(4) Mixtures of grasses and legumes should be fertilized to favor the desired plants of the mixture.

5. Weed and Brush Control. Mow grasses at least annually to control weeds and undesirable woody vegetation. Kudzu and Sericea lespedeza may be mowed annually but only after a killing frost. Care should be taken not to damage the vegetation mechanically through use of improper mowing equipment or by attempting to mow with heavy equipment on steep slopes when vegetation is lush and slippery or when the ground is soft enough to be rutted by mower or tractor wheels.

Caution: Pesticides are dangerous. Use only as directed and heed all precautions on the container label. Check the registration number and be sure that the directions for use include the target pests. Drift from aerial spraying can contaminate nearby crops and forage, lakes and reservoirs. Improper use and careless disposal of unused portions can lead to poisoning of humans, domestic animals, desirable plants, pollinating insects, fish and wildlife and can contaminate water supplies.

L.

CRITICAL AREA PLANTING  
(Stilling Sand in Coastal Dune Areas)

Where Applicable. Along the coastal beaches where blowing sand is a problem and where there is a need to: (1) build protective dunes; (2) prevent damaging erosion of established dune areas; (3) prevent accumulation of sand over roads, walks, buildings and other man-made works; and (4) impede sand encroachment and burying of sites already protected by perennial woody vegetation.

Specifications Guide

A. Planting Stock. American Beachgrass stems are used to establish plantings for stilling sand in beach areas. Two strains of American Beachgrass are in commercial production: "Lewes," the standard which was selected by the SCS in 1960, and "Hatteras" selected out of "Lewes" by the North Carolina State University in 1968. Another new and promising SCS strain found at Cape Cod, Massachusetts has been named "Cape." Preliminary tests indicate that it may be superior to the other two.

B. Planting.

1. Date. Plantings are made during the dormant season from about November 15 to April 1.

2. Methods. The culms, each with one to three to four stems, are planted 7" to 9" deep. A good tool for this job is a narrow bladed short handled spade. A wood splitting wedge welded to the end of a 1" pipe also works well. On large jobs, mechanical tobacco planters modified for deep planting have been used successfully. In all cases, the sand is thoroughly firmed around each plant after planting.

3. Spacing of Plants. For ordinary sand stilling on large bare sand areas, plants may be planted in 3-foot rows with plants 2 feet apart in the row. This is getting close to a maximum spacing, and amounts of 7,260 plants per acre. Where the force of the wind is severe (such as "blowouts", guts between dunes, dune tops, etc.), use 1½' rows with plants 1 foot apart.

4. Dune Building. The vigor of American Beachgrass enables it to grow up and through sand which drifts around it. Thus, dunes can be built by planting long parallel rows of grass. Such plantings are most often used to restore the frontal dune. Width of these plantings (number of rows) vary considerably. But, generally for a small group project or an individual cottager's undertaking, planting might vary from 12 to 24 feet wide. The rows are laid out so that the ones toward the center are closest. The middles get progressively wider toward both edges of the planting. This is to allow sand to drift into the center of the planting rather than pile up along the outside rows. Thus, a planting may have middles reading from outside to outside in feet: 3, 2, 1½, 1, 1½, 2, 3 feet; a total of 8 rows, 14 feet wide. For a larger planting, add outside rows with 4 feet middles. All plants in the row are spaced 1½ feet apart. Dune building may be speeded up by installing a 4-foot snow fence along the

centerline of the proposed dune. Rows, as above, are planted when the sand is within a foot or less of the top of the fence.

5. Use of Sea Oats. After the sand is stilled, American Beachgrass deteriorates unless fertilized frequently. To reduce this maintenance, the long lived sea oats should be introduced into the planting. This may be done either at planting time or at any later date. Two rows at a 10' x 10' spacing is enough to introduce the sea oats on a dune building job. Sea oats stock must be dug locally. Stems are planted about 1 foot deep. Usually a third or more of the leaf surface is buried. Deep planting is the secret of success. After time passes, sea oats gradually spreads and takes over.

6. Fertilization. Tests on beach sands prove that nitrogen is the most needed element. Phosphorus gives some response. Added potassium gives little to no response. An ideal beach fertilizer analysis is 30-10-0. Such a mixture is sometimes available or could be mixed. Lacking that, 10-10-10 or similar fertilizer is acceptable.

First Year of Establishment Broadcast:

March - 17 pounds of 10-10-10 per 1,000 square feet

September - 5 pounds of Ammonium Nitrate, or

6½ pounds of Cal Nitro, or

10 pounds of Nitrate of Soda per 1,000 square feet

C. Maintenance. Fertilize as above until good cover has been secured. Thereafter, fertilize in March and September but reduce rates to maintain good cover and grass color.



M.

CRITICAL AREA PLANTING  
(With Short-Term Seedings)

Where Applicable. Graded or cleared areas which may be subjected to erosion for up to 12 months and where a temporary seeding is needed to control erosion and water pollution prior to the establishment of finished grade to perennial vegetation. The temporary measures should be coordinated with the permanent erosion control measures planned to assure economical and effective control.

Specifications Guide

A. Site Preparation

1. Excessive water run-off must be controlled by planned and installed needed erosion control practices, such as closed drains, ditches, dikes, diversions, contour ripping, sediment basins or other erosion control methods.
2. Grade where practical and feasible to permit the use of conventional equipment for seed-bed preparation, seeding, mulch application and anchoring.

B. Materials

1. Lime and fertilizer treatment specified will be affected by site conditions, length of time short-term seedings are expected to be on the site, and the planned treatment to follow.
2. If soils are reasonably uniform, lime and fertilize according to soil test recommendations. Otherwise, apply 100 pounds of ground agricultural limestone or equivalent per 1,000 square feet or 2 tons per acre and apply 12 to 16 pounds of 10-10-10 or similar fertilizer per 1,000 square feet or 500-700 pounds per acre. On some sites, seeding may be done without liming or fertilization. Nitrogen top dressing may be applied after grass is up if needed for vigorous growth. Lime and fertilizer shall be spread uniformly over the area to be planted.
3. Where a permanent seeding is to follow the temporary cover, optimum land preparation should be done. When further grading is to be done before the permanent seeding or where site conditions are favorable, minimum preparation may be satisfactory for establishing temporary cover. For optimum results, work lime and fertilizer into the soil to a depth of 3-4 inches using disks, chisels, rotary tillage equipment or other suitable equipment. On sloping land, the final tillage operation should be on the general contour. The adequacy of minimum preparation is dependent upon site condition. In general, if the soil surface is such that the seeds of plants with high seedling vigor can be placed so as to remain in contact with moist soil, no preparation is required.

### C. Seeding

1. Select from the following table a quick growing grass with high seeding vigor that is suited to the area time of planting and that will provide a temporary cover which will not interfere with the plants to be sown later for permanent cover. Seedings made in December and January will not provide effective short-term cover. Mulch without seeding should be considered for this period.

<u>Late Winter-Spring</u>	<u>Per 1,000 sq. ft.</u>	<u>Per Acre</u>
Oats	2 lbs	3 bu
Rye	3 lbs	2-3 bu
Ryegrass	1 lb	30-40 lbs
Oats and Ryegrass	1 lb $\frac{1}{2}$ lb	$1\frac{1}{2}$ lbs 20 lbs
Oats and Korean Lespedeza	1 lb $\frac{1}{2}$ lb	$1\frac{1}{2}$ bu 20 lbs
<u>Summer</u>		
Sudangrass	1 lb	35-45 lbs
Browntop Millet	1 lb	30-40 lbs
Weeping Lovegrass	2 lbs	4-6 lbs
<u>Late Summer/Early Winter</u>		
Rye	3 lbs	2-3 lbs
Ryegrass	1 lb	30-40 lbs
Oats (Before Oct 1)	2 lbs	3 bu
Barley (Before Oct 15)	3 lbs	2-3 bu
Wheat (After Oct 1)	3 lbs	2-3 bu
Rye and Ryegrass	$1\frac{1}{2}$ lbs $\frac{1}{2}$ bu	1 bu 20 lbs

NOTE: All seed used in contracts shall have been tested not more than six (6) months prior to date of seeding. The specifications shall state the acceptable per cent purity, germination and number of noxious weed seed per pound.

2. Apply seed uniformly by hand, cyclone seeder, drill, cultipacker seeder or hydraulically (slurry may include fertilizer, seed and cellulose fiber mulch). Seed should be covered from  $\frac{1}{2}$  to 1 inch deep except when hydro-seeder is used.

3. When a hydro-seeder or cultipacker type seeder is not used, the seedbed should be firmed following seeding using such equipment as a cultipacker, roller, or light drag; or following dry mulch application, with the mulch anchoring tool, disk harrow set straight, or stalk cutter. On sloping land, seeding operation should be performed across the slope.

D. Mulching. Mulching should usually be specified to reduce damage from water run-off and improve moisture conditions for seedlings. Temporary vegetation can in some cases be satisfactorily established without the use of mulch. The use of mulch is a judgment decision based on time of seeding and conditions of individual sites.

1. Mulching Materials

a. Dry unchopped, unweathered small grain straw or hay free of seeds of competing plants. Spread at the rate of 1 to 2 tons per acre, depending upon the site and season. Evenly spread mulch over the area by hand or blower-type spreading equipment. Apply mulch uniformly so that about 25% of the ground surface is visible.

b. Local materials such as burlap, tobacco plant bed netting and pine boughs. Cover entire area; secure in place if flowing water is involved.

c. Barnyard manure and bedding. Apply uniformly so that about 25% of the ground surface is visible.

d. Jute matting is a coarse, open mesh material woven of heavy jute twine. It may be used in the place of mulch or sod and has the strength to withstand waterflow. It is an accepted practice to sow half the seed before placing the matting. Sow the remaining half after the matting is laid. See the manufacturer's specifications for installing.

e. Wood fiber (excelsior) is available as mulch material to be blown on after seeding or as a matting to be stapled on steep slopes, waterways, etc. See the manufacturer's specifications for installing.

f. Wood cellulose fiber mulch is mixed with seed, fertilizer and water. The resulting slurry is sprayed on with hydraulic seeding equipment. Use at the rate of 500 pounds per acre where straw or hay is to be applied. Use at the rate of 1,000 to 1,500 pounds per acre without other mulching materials. Applied in a slurry, wood cellulose fiber mulch is self-anchoring.

2. Mulch Anchoring Methods. Anchor mulch immediately after placement to minimize loss by wind and water. Consider size of area, type of site and cost and select one of the following:

a. Mulch anchoring tool with a series of flat notched disks that punch and anchor mulch material into the soil. A regular farm disk weighted and set nearly straight may be substituted but will not perform as well as a mulch anchoring tool. The disk should not be sharp enough to cut up the mulch. The soil should be moist, free of roots and loose enough to permit penetration to a depth of 3 inches. Operate on the contour where practical.

b. Mulch nettings. Staple light weight paper, jute, cotton, plastic or wire nettings to the soil surface according to manufacturer's specifications. These nettings are usually in rolls 3 to 4 feet wide and up to 300 feet long.

c. Peg and twine. Drive 8 to 10 inch wooden pegs to within 2 to 3 inches of the soil surface every 4 feet in all directions. Stakes may be driven before or after applying mulch. Secure mulch to soil surface by stretching twine between pegs in a criss-cross within a square

pattern. Secure twine around each peg with two or more round turns. Poles and stakes may also be used to secure brush in place.

d. Pick chain. This rolling spiked-chain implement can be operated on slopes of 3:1 gradient or steeper. It is attached to a tractor or truck which operates along the top of the slope. The pick chain can also be used for seedbed preparation and mixing lime and fertilizer with the soil.

e. Slit. With a square pointed spade, cut mulch into the surface soil in contour rows 18 inches apart.

f. Asphalt mulch tie-down. Asphalt sprayed uniformly on the mulch as it is ejected from the blower is more effective than applied as a separate operation. Rates of application will vary with conditions. Apply so area has uniform appearance.

(1) Emulsified asphalt. Apply uniformly 0.04 gallons per square yard or 200 gallons per acre. See the manufacturer's specifications. Emulsified asphalt should not be used in freezing weather since it contains approximately 50% water.

(2) Liquid asphalt. May be applied at any time of the year since it is thinned with a kerosene-like product. Uniformly apply 0.10 gallons per square yard or 500 gallons per acre. See the manufacturer's specifications.

NOTE: In areas of playing children or pedestrian traffic, the use of asphalt could cause problems of "tracking in" on rugs, damaging shoes, clothing, etc.

g. Mulch can be anchored with rye for fall plantings or millet for summer plantings. Use  $\frac{1}{2}$  bushel of rye or 15 pounds of millet per acre broadcast ahead of mulch application.

E. Irrigation (If needed). Water should be applied as soon as the mulch is applied at a rate that does not cause runoff and erosion. If sprinkler irrigation equipment cannot be used and water is applied from a tank truck, use a nozzle that will produce a spray that will not dislodge the mulch. A second application should be made in 10 days if no rainfall has occurred.

N.

CRITICAL AREA PLANTING (Ac.)

(With Shrubs, Vines, Trees, and Other Plants)

Where Applicable. On graded or cleared areas subject to erosion where a permanent, long-lived vegetative cover other than turf is desired; to stabilize the area; to enhance natural beauty and environmental quality.

Specifications Guide

A. Plant Selection. The plants in this group were selected because they have some definite conservation use and in addition have the ability to grow on certain problem soils and site conditions. It is not a complete list, but rather a collection of the more common plants—most of which are available at commercial nurseries.

B. Planting. Early spring. This allows for the maximum root and top development to check erosion and allows the plant to become established before winter.

C. Soil Preparation

1. It is expected that the soils at most critical area planting sites will be amended by the addition of topsoil, compost, peat, sawdust, manure or other organic material. Fertilizer will be used for each planting. Lime will also be required unless the soil is known to have a pH of 6 or above or if the plant requires an acid site.

2. For close spaced mass plantings, apply a commercial granular fertilizer such as 5-10-10 and organic supplement (such as composted cow manure, peat or well-rotted sawdust), and work into the soil prior to planting. Fertilizer rate - 3 to 5 pounds per 100 square feet. The amount of organic material needed will depend upon the soil and plant being used. Plants such as Pachysandra require a high rate of organic material, about a 2-inch layer worked into the root zone. Depending on the soil type and steepness of slope, the depth of soil working will vary from 4 to 6 inches.

3. For mass plantings on steep slopes (3 to 1 or steeper), working up the entire planting area would not be practical and would induce erosion. Instead, work up the soil in contour rows or dig single holes for each plant. Blend the needed lime, fertilizer and organic material with the soil removed from each hole or furrow. Great care must be taken to avoid fertilizer burn. Use it sparingly. Mix it thoroughly with the soil before planting. If the soil on the slope is not suitable for plant growth, it is best to batch blend a planting medium, such as a mixture of 1:1 or 2:1 sandy loam soil and peat, composted cow manure or well-rotted sawdust and 10 pounds of 5-10-10 and 20 pounds of lime per cubic yard of soil mix. (If manure is used, delete the 5-10-10.)

4. The entire planted slope should be covered with a protective mulch such as wood chips, grain or pine straw or other weed free organic material. These are essential to conserve moisture, control erosion and suppress weeds. (Note: It requires about a 6-inch layer of mulch to prevent weed growth.)

5. Where erosion hazard is very high, heavy jute matting stapled to the slope will provide excellent erosion control, as will landscape mats of fiberglass or excelsior.

6. For spaced plantings of individual vines, shrubs or trees, single holes are dug for each plant. Holes must be at least a third larger than needed to accommodate the root system. If the soil removed from the hole is moderately suitable for plant growth, the organic material, lime and fertilizer may be blended with it and the mixture used for refilling. If the soil is very poor (such as parent material) mix up a batch of topsoil as described above and use for refilling. The soil around each plant must be thoroughly firmed and left in a saucer-like space to retain water. The plant must then be watered and mulched. Support tall tree transplants with guy wires.

#### E. Maintenance

1. Some watering, weeding, remulching and feeding may be required for new ground covers or spaced plantings during the period of establishment. Cultivation as such is not recommended as this may encourage erosion and might also cause some root injury. Competing weeds should be pulled.

2. Fertilize the plantings the spring of the second growing season and thereafter as needed using 2 to 3 pounds of a granulated commercial fertilizer such as 5-10-10 per 100 square feet.

Table 15

PLANT SPECIES	CONS. USE*	ADAPTED FOR SITES**	GROWTH		HEIGHT
			RAPID MEDIUM SLOW		
<b>A. LOW MAT FORMING EVERGREENS</b>					
Bugleflower ( <i>Ajuga reptans</i> )	1	a, f	R		4-8"
Lilyturf ( <i>Liriope spicata</i> )	1	a, f	S		8-12"
Aaronsbeard ( <i>hypericum calycinum</i> )	1	a, b, f	R		10-12"
Japanese spurge ( <i>Pachysandra terminalis</i> )	1, 6	f	S-M		6-12"
Moss pink ( <i>Phlox subulata</i> )	1	a, b	S		6"
Lavender cotton ( <i>Santolina chamaecyparissus</i> )	1, 9	a, b	M		1-2'
Green santolina ( <i>Santolina virens</i> )	1, 9	a, b	M		10-16"
Wineleaf cinquefoil ( <i>Potentilla tridentata</i> )	1	a, b, c	S		4-12"
<b>B. HERBACEOUS PLANTS</b>					
Daylily ( <i>Hemeracallis</i> sp.)	1, 2, 9	a, b	M		16-24"
Iris (bearded) ( <i>Iris</i> sp.)	1	a, b	S		1-2'
Everlasting pea ( <i>Lathyrus latifolius</i> )	1	a, b	S		1-1½'
Beargrass ( <i>Yucca filamentosa</i> )	1, 6, 9	a, b	S		1-2'
Spanish bayonet ( <i>Yucca alnifolia</i> )	1, 6, 9	a, b	S		4-10'
Bamboo (Various species)	1, 3	a	S		1-20'
<b>C. EVERGREEN VINES</b>					
English Ivy ( <i>Hedera helix</i> )	1, 6	a, f	M		1'
Wintercreeper ( <i>Euonymus fortunei</i> )	1, 6	c, f	S		10"
Honeysuckle ( <i>Lonicera japonica</i> )	1, 2, 7, 8	a, b, c, e, f	M		2'
Periwinkle ( <i>Vinca minor</i> )	1, 6	f	M		8"
Carolina jessamine ( <i>Gelsemium sempervirens</i> )	1	a, b, c, e	S		16"

PIANT SPECIES	CONS. USE*	ADAPTED FOR SITES**	GROWTH		HEIGHT
			<u>RAPID</u>	<u>MEDIUM</u> <u>SLOW</u>	
<b>D. DECIDUOUS VINES</b>					
Virginia creeper ( <i>Parthenocissus quinquefolia</i> )	1,6,7,9	a,b,c,e	M		
Peppervine ( <i>Ampelopsis arborea</i> )	1, 9	a,b,c,e	R		
Porcelain vine ( <i>Ampelopsis brevipedunculata</i> )	1, 7	a, f	M		
Muscadine grape ( <i>Vitis rotundifolia</i> )	1,7,8,9	a,b,c,e,f	S		
Kudzu ( <i>Pueraria thunbergiana</i> )	1, 2	a,b,c	R		
Trumpet creeper ( <i>Campsis radicans</i> )	1	a,b,c,e	R		
<b>E. EVERGREEN SHRUBS WITH NEEDLES</b>					
Creeping juniper ( <i>Juniperus horizontalis</i> )	1, 6	a,b	S		12-16"
Sargent juniper ( <i>Juniperus chinensis sargentii</i> )	1,6,9	a, b	S		2-3'
Pfitzer's juniper ( <i>Juniperus chinensis pfitzeriana</i> )	1,6,9	a, b	S		3-6'
Shore juniper ( <i>Juniperus conferta</i> )	1,6,9	a, b	M		1-2'
<b>F. EVERGREEN SHRUBS - BROADLEAF</b>					
Thorny elaeagnus ( <i>Elaeagnus pungens</i> )	1,3,4,5, 6,7,9	a,b,f	M		6-10'
Bigleaf winter creeper ( <i>Euonymus fortunei vegetus</i> )	1,2,6	a,e,f	M		3-4'
Evergreen euonymus ( <i>Euonymus japonicus</i> )	3,4,6,9	a, b	R		7-10'
Wax myrtle ( <i>Myrica cerifera</i> )	1,3,7,8,9	a,c,d	M		10-30'
Bayberry ( <i>Myrica pennsylvanica</i> )	1,7,8,9	a,b,c	M		4-7'
Yaupon holly ( <i>Ilex vomitoria</i> )	3,7,9	a,b,c,d	S		10-24'
Inkberry ( <i>Ilex glabra</i> )	1	a,d	S		6-9'



PLANT SPECIES	CONS. USE*	ADAPTED FOR SITES**	GROWTH		HEIGHT
			RAPID	MEDIUM SLOW	
<b>F. EVERGREEN SHRUBS--BROADLEAF (CON'T)</b>					
California privet ( <i>Ligustrum ovalifolium</i> )	1,3,4,9	a, b	R		10-15'
Japanese privet ( <i>Ligustrum japonicum</i> )	1,3,4 6, 9	a,b,f	R		8-16'
Glossy privet ( <i>Ligustrum lucidum</i> )	1,3,6	a, b	R		15-30'
Regel privet ( <i>Ligustrum obtusifolium regelianum</i> )	1,6,7,9	a, b	R		4-5'
Oleander ( <i>Nerium oleander</i> )	9	a, b	M		7-15'
Pittosporum ( <i>Pittosporum tobira</i> )	3,6,9	b	M		6-10'
Wintergreen barberry. ( <i>Berberis julianae</i> )	1,4,5	a,b,f	S		4-6'
Firethorn ( <i>Pyracantha coccinea</i> )	3,5,7,8	f	M		6-10'
<b>G. DECIDUOUS SHRUBS</b>					
Tatarian honeysuckle ( <i>Lonicera tartarica</i> )	1, 7	a, b	R		10-15'
Arnold dwarf forsythia ( <i>Forsythia arnoldi</i> )	1, 6	a, b	R		2-3'
Showy forsythia ( <i>Forsythia intermedia spectabilis</i> )	1, 6	a, b	R		7-9'
Goldflower ( <i>Hypericum moserianum</i> )	1	a, b	R		2-3'
Winter jasmine ( <i>Jasminum nudiflorum</i> )	1	a, b	M		2-4'
Beautyberry ( <i>Callicarpa americana</i> )	1,7,8,9	a, b	M		3-5'
Rugosa rose ( <i>Rosa rugosa</i> )	1,5,6,7,9	a, b	R		4-6'
Memorial rose ( <i>Rosa wichuraiana</i> )	1, 6	a,b,c,e	M		1-2'
Scotch broom ( <i>Cytisus scoparius</i> )	1, 9	a, b	R		5-7'

PLANT SPECIES	CONS. USE*	ADAPTED FOR SITES**	GROWTH		HEIGHT
			RAPID MEDIUM SLOW		
G. DECIDUOUS SHRUBS (CON'T)					
Autumn olive ( <i>Elaeagnus embellata</i> )	1,3,7,8,9	a,b,c	R		7-11'
Tag alder ( <i>Alnus rugosa</i> )	2	d	M		6-15'
Rose acacia ( <i>Robinia hispida</i> )	1	a,b,c	R		5-8'
Elderberry ( <i>Sambucus canadensis</i> )	2, 7	d	R		9-12'
New Jersey tea ( <i>Ceanothus americanus</i> )	1	a,b,c	M		2-4'
Shining sumac ( <i>Rhus copallina</i> )	1,8,9	a,b,c	R		11-15'
Smooth sumac ( <i>Rhus glabra</i> )	1,8,9	a,b,c	R		12-20'
Fragrant sumac ( <i>Rhus aromatica</i> )	1	ab,c,	R		3-6'
Coralberry ( <i>Symphoricarpos orbiculatus</i> )	1, 8	a, b	M		1-2'
Halberd willow ( <i>Salix hastata</i> )	2	a, d	R		4-5'
Sandbar willow ( <i>Salix interior</i> )	2	a, d	R		6-12'
Bicolor lespedeza ( <i>Lespedeza bicolor</i> )	1, 8	a, b	R		6-10'
Japonica lespedeza VA-70 ( <i>Lespedeza japonica</i> VA-70)	1, 8	a, b	R		4-6'
H. TREES					
Carolina laurel cherry ( <i>Prunus caroliniana</i> )	2,3,4, 7,8,9	a,b,c,f	R		15-30'
Chinese chestnut ( <i>Castanea Mollissima</i> )	1,2,5,7,8	a,b,c	R		50-60'
Eastern redcedar ( <i>Juniperus virginiana</i> )	1,3,5,7,8	a,b,c,f	M		40-50'

PIANT SPECIES	CONS. USE*	ADAPTED FOR SITES**	GROWTH		HEIGHT
			RAPID MEDIUM SLOW		
H. TREES (CON'T)					
Japanese black pine (Pinus thunbergii)	1,3,7,8,9	a,b,c,d,e	M-R		90-100'
Loblolly pine (Pinus taeda)	1,2,3, 7,8	a,b,d,c,e	R		90-100'
Virginia pine (Pinus virginiana)	1,3,5,7,8	a,b,c,e	M-R		40-50'
Eastern redbud (Cercis canadensis)	1,2,7,8	a,b,c,f	M-R		15-45'
River birch (Betula nigra)	1,2,7,8	a,b,c,f	M-R		50-60'
White poplar (Populus alba)	1,2,6,9	a,b,c,e	R		25-35'

\*Conservation Uses:

1. Critical area erosion control and beautification
2. Shorelines, stream and ditch banks
3. Screens and windbreaks
4. Clipped hedges
5. Foot traffic barriers
6. City conditions (smog, etc.)
7. Songbird food or cover
8. Upland game bird food or cover
9. Seashore

\*\*Soil & Site Conditions

- a. Infertile soils
- b. Dry sites
- c. Acid soils
- d. Wet sites
- e. Steep cuts
- f. Shady locations

O. SPECIFICATIONS FOR SAND-CEMENT BAG RIPRAP  
FOR CULVERT HEADWALLS IN SMALL CHANNELS

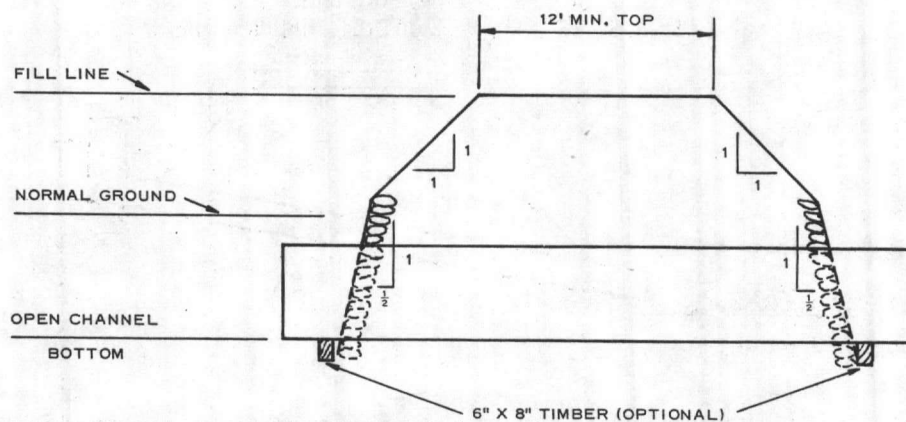

O. SPECIFICATIONS FOR SAND-CEMENT BAG RIPRAP  
FOR CULVERT HEADWALLS IN SMALL CHANNELS

- MATERIALS:** Portland Cement shall be Type I. Sand shall have little or no organic matter. Bags shall be cloth or burlap that will hold a sand-cement mixture without leakage.
- SUBGRADE:** A trench having a minimum depth of 12 inches shall be cut into the channel banks and bottom so the bags can be keyed in. A firm foundation shall be provided for the first layer.
- PREP:**
- MIXTURE:** One part cement to five or six parts sand shall be thoroughly mixed in a dry condition and placed in bags of convenient size.
- PLACEMENT:** The bags shall be laid in rows or courses with the joints between bags in adjacent rows or courses staggered as in brick work. All bags should be compacted against the subgrade, the culvert and each other so as to form a close and molded contact.
- WETTING:** Moisture can be applied by sprinkling each row adequately for the mortar to set. Good results have also been obtained by laying the entire wall dry and then sprinkling thoroughly.
- BACKFILL:** Place and compact fill to make an "Island Type Structure" so that major floods will bypass rather than overtop the installation.

P. CROSS SECTION OF DIVERSION FOR THE TANK TRAIL

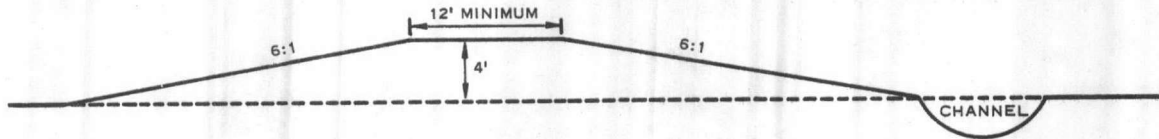

Q. TYPICAL CROSS SECTION OF THE DIKE PROPOSED FOR THE 1800 AREA WITH PIPE OUTLET THROUGH THE DIKE

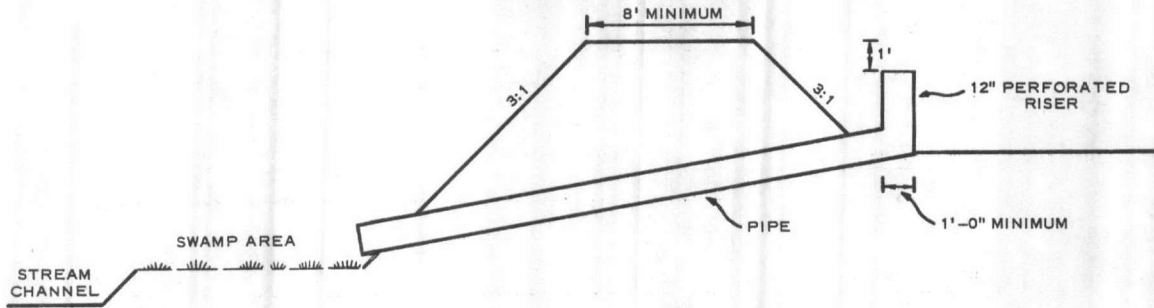

R. DEBRIS (SEDIMENT) BASIN

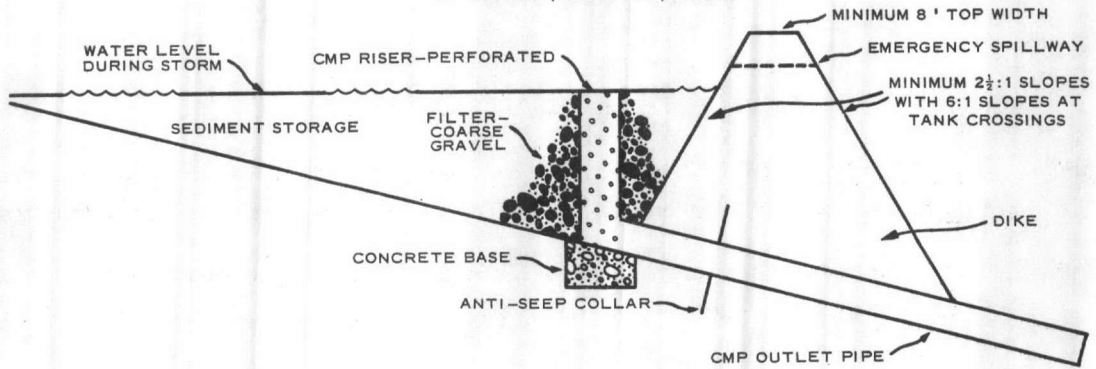

S. DIVERSIONS WITH PIPE DROPS

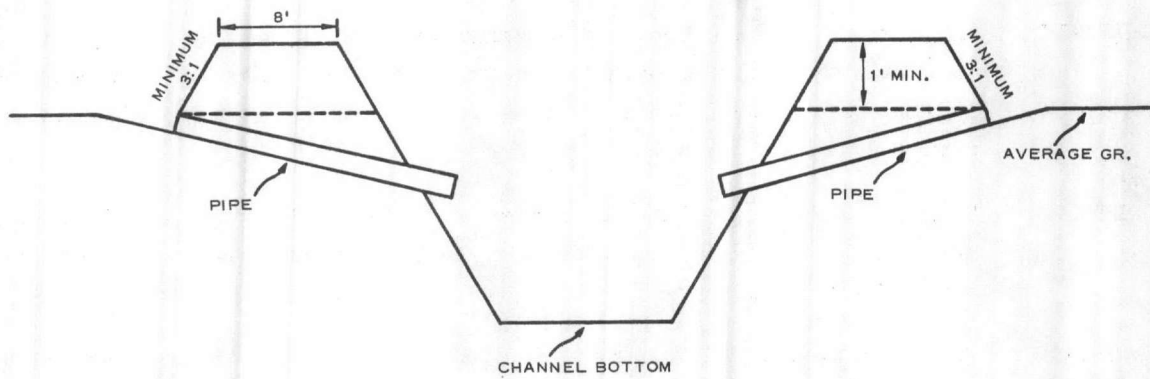

T. EXAMPLE OF STORM WATER DETENTION BASIN AS DESIGNED FOR THE BERKLEY MANOR AREA

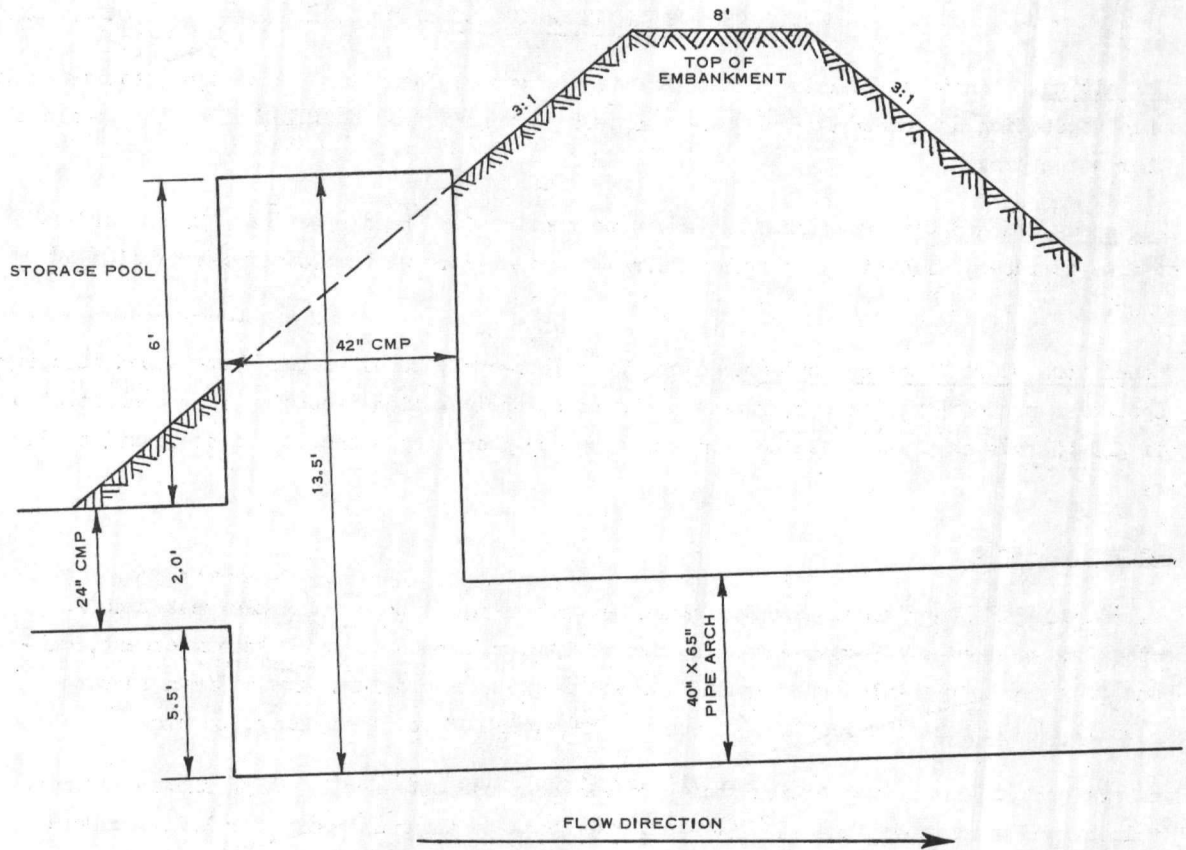

U. CATCH BASIN

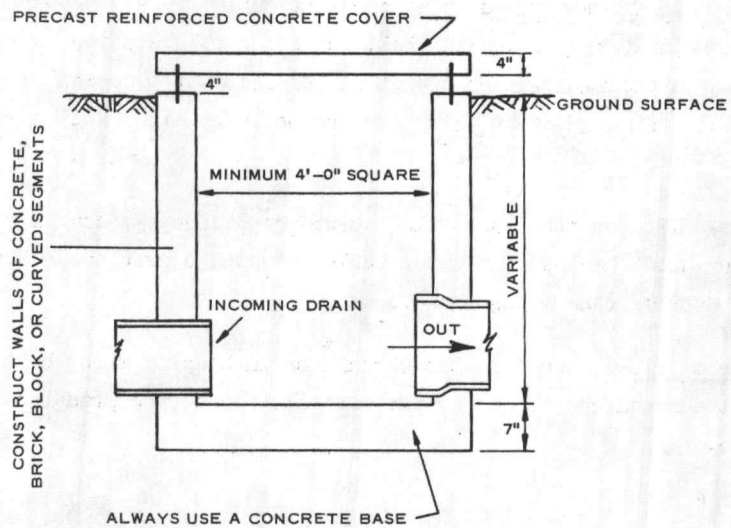

ON SLOW SOIL AND WATER  
CONSERVATION DISTRICT  
ENGINEERING STANDARD

V. GRASSED WATERWAY OR OUTLET

1. Definition. A natural or constructed waterway or outlet shaped or graded and established in suitable vegetation as needed for the safe disposal of runoff from a field, diversion, terrace or other structure.

2. Purpose. Grassed waterways or outlets are to provide for the disposal of excess surface water from terraces, diversions or from natural concentrations without damage by erosion or flooding.

3. Conditions Where Practice Applies. These practices apply to all sites where added capacity or vegetative protection, or both, are required to control erosion resulting from concentrated runoff and where such control can be achieved by these practices alone, or in combination with others.

4. Design Criteria

a. Capacity. The minimum capacity shall be that required to confine the peak runoff expected from a storm of 10-year frequency except that on slopes of less than 1 percent, out-of-bank flow may be permitted where such flow will not cause erosion. The minimum in such cases shall be the capacity required to remove the water before flood damage occurs.

b. Velocity. Design velocities shall not exceed those obtained by using the procedures, "n" values, and recommendations in SCS-TP-61, "Handbook of Channel Design for Soil and Water Conservation."

c. Width. The bottom width of trapezoidal waterways or outlets shall not exceed 100 feet unless multiple or divided waterways or other means are provided to control meandering of low flows.

d. Depth. The minimum depth of a waterway or outlet receiving water from terraces, diversions or other tributary channels shall be that depth required to keep the design water surface elevation in the waterway or outlet at, or below, the design water surface elevation in the terrace, diversion or other tributary channel at their junction when both are flowing at design depth.

e. Drainage. Tile or other suitable subsurface drainage measures shall be provided for in the design for sites having high water table or seepage problems, except where water-tolerant vegetation such as Reed canarygrass can be used.

5. Specifications Guide. Specifications shall be in keeping with the preceding standard and shall describe the requirements for proper installation of the practice to achieve its intended purpose.

### PARABOLIC CROSS SECTION

T = DESIGN AND 7-5  
D = DESIGN DEPTH

BOTH VALUES INCLUDE ALLOWANCE  
FOR THE VEGETATIVE LINING.

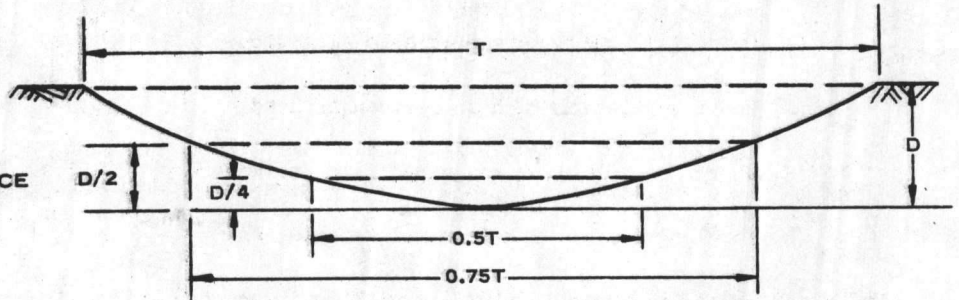

### TRAPEZOIDAL CROSS SECTION

B = DESIGN BOTTOM WIDTH  
d = DESIGN DEPTH  
D = DESIGN DEPTH PLUS ALLOWANCE  
FOR VEGETATIVE LINING  
t = DESIGN TOP WIDTH  
T = DESIGN TOP WIDTH PLUS ALLOWANCE  
FOR VEGETATIVE LINING  
z = SIDE SLOPE RATIO

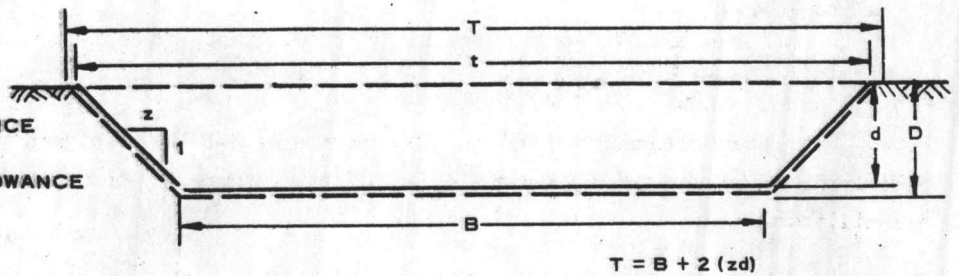

### TRIANGULAR CROSS SECTION

d = DESIGN DEPTH  
D = DESIGN DEPTH PLUS ALLOWANCE  
FOR VEGETATIVE LINING  
t = DESIGN TOP WIDTH  
T = DESIGN TOP WIDTH PLUS ALLOWANCE  
FOR VEGETATIVE LINING  
z = SIDE SLOPE RATIO

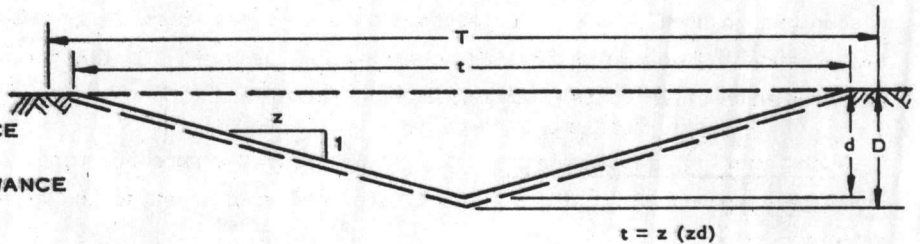



## 6. Design Criteria

a. Depth: The minimum depth shall not be less than 1.0 foot with 0.2 of a foot considered a reasonable tolerance. Waterways deeper than minimum required should be planned:

- (1) On soils subject to appreciable siltation;
- (2) Where vegetation such as sericea is used;
- (3) Where needed to get row water into the waterway;
- (4) For longer life with less maintenance; and
- (5) Where it does not interfere with equipment operation.

### b. Vegetation

(1) Adequate vegetation should be established. Site preparation, lime, fertilizer, seeding, and mulching will be specified for each job.

(2) Lime will be applied according to soil test, or apply two tons of lime per acre if no lime has previously been used.

(3) One thousand (1,000) to 2,000 pounds of 5-10-10 or higher analysis fertilizer will be applied per acre in the absence of soil test. Manure may be substituted for part of the fertilizer.

(4) Incorporate lime and fertilizer into the soil.

(5) The area shall be seeded, selecting one of the best adapted plants or combination of plants for the site from the attached table.

(6) Mulch should be applied covering 50-75 percent of the ground. Mulch, matting or a combination should be used on steep slopes or areas where large volumes of water are concentrated and tied down with netting, brush, poles or wire. On flatter slopes, mulch may be anchored with stalk cutter or disk harrow, set straight.

7. Construction Specifications. All trees, brush, stumps and other objectionable material shall be disposed of so they will not interfere with construction or proper functioning of the waterway or outlet.

a. The waterway or outlet shall be shaped or constructed to the specified dimensions and cross section, free of bank projections or other irregularities.

b. All earth removed and not needed in construction of the waterway or outlet shall be spread or disposed of so it will not interfere with the functioning of the waterway. Where the topsoil is removed and infertile subsoil is exposed in excavating for the waterway, it should be resurfaced with sufficient topsoil to provide a suitable seedbed.

Table 16

Plants <u>2/</u>	Planting Dates <u>1/</u>		Planting Rates	
	Coastal Plain		Waterways <u>12/</u>	
Tall Fescue <u>3/</u>	Sep 1 - Oct 15	Alone	30-60	
	Feb 1 - Apr 1	Mixture	20-30	
Pensacola bahia	Mar 15 - May 15	Alone	30-40	
		Mixture	20-30	
Wilmington bahia	Mar 15 - Jun 1	Alone	30-40	
		Mixture	20-30	
Bermudagrass (Hulled) <u>6/</u>	Jan 1 - Mar 15	Alone	8-12	
		Mixture	6-8	
Bermudagrass (unhulled) <u>6/</u>	Jan 1 - Mar 15	Alone	—	
		Mixture	8-10	
Bermudagrass (Sprigs) <u>7/</u>	Feb & March	—	1'x1'	
		Rows	1'x2'	
Coastal Bermuda (Sprigs)	Feb & March	Broadcast	40-60	
		Carpetgrass	20-25	
Dallisgrass	Feb & March	Broadcast	15-20	
		Lovegrass <u>6/</u>	Alone	—
Orchardgrass <u>3/</u>	Mar 15 - Jul 1	Mixture	4-5	
		Sep 1 - Oct 15	Alone	40-60
Reed Canarygrass	Feb 1 - April 1	Mixture	20-30	
		—	20-25	
Switchgrass	—	Broadcast	15-20	
		Alone	—	
Sericea (Scarified)	Feb 15 - Apr 15	Mixture	15-20	
		Alone	40-60 <u>11/</u>	
Sericea (Hulled-unscarified)	Mar 1 - Apr 15	Mixture	25-35	
		Alone	—	
Sericea (Combine-run)	Nov 1 - Feb 15	Mixture	40-50 <u>11/</u>	
		Alone	—	
White Clover <u>3/</u>	Jul 15 - Dec 1	Mixture	50-60 <u>11/</u>	
		Sep 1 - Oct 15	Alone	—
	Feb 1 - Apr 1	Mixture	2-5	

1. The range in planting dates is for the physiographic area. When planting dates must be advanced or delayed to coincide with completion of construction, compensate for the less desirable date by mulching, irrigation, etc.
2. Judgment should be used in selecting plants from the table for the specific site condition. A plant may be listed as usable on a site, but may not be the best or preferred one to select; i.e., tall fescue grass is preferred over orchardgrass.
3. Fall seeding is more successful than spring seeding.
6. Mix with cottonseed meal, sawdust, etc. when seeding alone in order to obtain better distribution.
7. Instead of sprigging, the area may be covered with 3" or more of soil containing ample sprigs.

11. When used in waterways, the design capacity shall be increased by an amount equal to that which sericea reduces the volume flow.

12. Use Bermuda or bahiagrass where velocities of water are greater than 5 feet per second. On dry, infertile, sandy sites, do not use fescue; use Bermuda or bahia. On wet sites with velocities below 5 feet per second, use fescue, carpetgrass or reed canarygrass.

ONSLOW SOIL AND WATER  
CONSERVATION DISTRICT  
ENGINEERING STANDARD

W.

DIVERSION

1. Definition. A channel with a supporting ridge on the lower side constructed across the slope.
2. Scope. This standard covers the installation of all diversions except flood-water diversions.
3. Purpose. The purpose of this practice is to divert water from areas where it is in excess to sites where it can be used or disposed of safely. Diversions are not applicable below high sediment producing areas unless land treatment practices or structural measures, designed to prevent damaging accumulations of sediment in the channels, are installed with or before the diversions.
4. Design Criteria.

a. Capacity. Diversions must have the capacity to carry the peak runoff from a 10-year frequency storm as a minimum, with a freeboard not less than 0.3 foot. Diversions designed to protect buildings and roads, and those designed to function in connection with other structures, shall have enough capacity to carry the peak runoff expected from a storm frequency consistent with the hazard involved.

b. Cross Section. The channel may be parabolic, V-shaped or trapezoidal. The diversion shall be designed to have stable side slopes. The ridge height shall include a reasonable settlement factor. The ridge shall have a minimum top width of 4 feet at the design elevation. The minimum cross section shall meet the specified dimensions. The top of the constructed ridge shall not be lower at any point than the design elevation plus the specified overfill for settlement.

c. Location. Diversion location shall be determined by outlet conditions, topography, land use, cultural operations, soil type and length of slope.

d. Protection Against Sedimentation. When movement of sediment into the channel is a significant problem, a vegetated filter strip shall be used except where soil and/or climate preclude the use of such strips. In this latter case, the design shall include extra capacity for sediment and be supported by supplemental structures, cultural or tillage practices and special maintenance measures.

e. Outlets

(1) Each diversion must have an adequate outlet. The outlet may be a grassed waterway, vegetated area, grade stabilization structure, stable watercourse, or tile outlet. In all cases the outlet must convey runoff to a point where outflow will not cause damage. Vegetative outlets shall be installed before diversion construction if needed to insure establishment of vegetative cover in the outlet channel.

# DIVERSION CONSTRUCTION WITH MOTOR PATROL

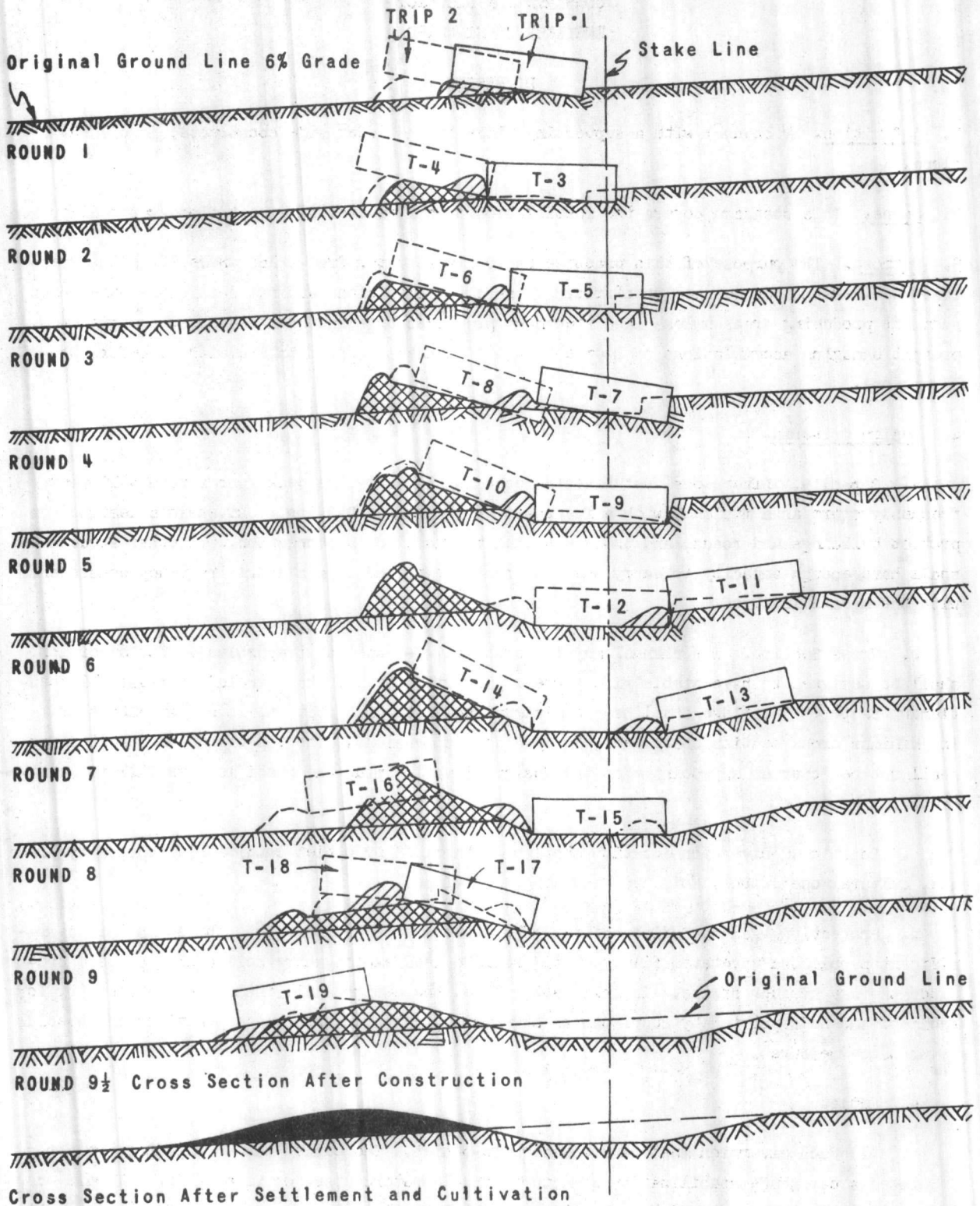

Progressive steps in constructing a diversion with grader or motor patrol. The diversion is constructed from the upper side only.

(2) The design elevation of the water surface in the diversion shall not be lower than the design elevation of the water surface in the outlet at their junction when both are operating at design flow.

f. Velocities.

The maximum safe velocities will depend upon the erodibility of the soil, the type of vegetative cover to be established, if any, and the degree of maintenance that can reasonably be expected.

g. Vegetation. All diversions on grades averaging more than 0.5 percent (except for upper 200' or outlet end) shall have an adequate vegetation established. Select the plant or a combination of plants from the attached table. Site preparation, liming, fertilizing, seeding and mulching will be specified in detail for these conditions.

h. Lime and Fertilizer. High level of fertilization should be used. Sufficient amounts of lime and fertilizer will be used to insure adequate growth of the type of vegetation used. Soil test will be used as a guide for fertilizing, if available.

5. Construction Specification. All dead furrows, ditches or gullies to be crossed shall be filled before construction begins or as a part of construction. All old terraces, fence rows, or other obstructions that will interfere with the successful operation of the diversion shall be removed.

Table 17. SELECTION OF PLANTS FOR DIVERSIONS

Plants <u>2/</u>	Planting Dates <u>1/</u>		Planting Rates	
	Coastal Plain		Diversions	
Tall Fescue	Sep 1 - Oct 15	Alone	30-40	
	Feb 1 - Apr 1	Mixture	20-30	
Pensacola bahia	Mar 15 - May 15	Alone	30-40	
		Mixture	20-30	
Wilmington bahia	Mar 15 - Jun 1	Alone	30-40	
		Mixture	20-30	
Bermudagrass (Hulled) <u>5/ 6/</u>	Mar 15 - Jul 1	Alone	8-12	
		Mixture	4-5	
Bermudagrass (Unhulled) <u>5/ 6/</u>	Jan 1 - Mar 15	Alone	10-15	
		Mixture	8-10	
Bermudagrass (Sprigs) <u>5/ 7/</u>	Feb & March	—	2'x2'	
		Rows	10-15	
Coastal Bermuda (Sprigs) <u>8/</u>	Feb & March	Broadcast	40-60	
		Broadcast	20-25	
Carpetgrass <u>12/</u>	Mar 15 - May 1	Alone	30-50	
		Mixture	20-30	
Orchardgrass	Sep 1 - Oct 15	Alone	30-50	
		Feb 1 - Apr 1	Mixture	20-30
Switchgrass	Feb 15 - Apr 15	Alone	—	
		Mixture	15-20	
Alfalfa <u>3/</u>	September	Alone	—	
		Mixture	15-20	
Sericea (Scarified)	Mar 1 - Apr 15	Alone	40-50 <u>11/</u>	
		Mixture	25-35	
Sericea (Hulled-unscarified)	Nov 1 - Feb 15	Alone	50-60 <u>11/</u>	
		Mixture	40-50	
Sericea (Combine-run)	July 15 - Dec 1	Alone	70-80 <u>11/</u>	
		Mixture	50-60	
White Clover <u>3/</u>	Sep 1 - Oct 15	Alone	—	
		Feb 1 - Apr 1	Mixture	2-4

1. The range in planting dates is for the physiographic area. Insert the best date for the work unit within this range. When planting dates must be advanced or delayed to coincide with completion of construction, compensate for the less desirable date by mulching, irrigation, etc.
2. Judgment should be used in selecting plants from the table for the specific site condition. A plant may be listed as usable on a site, but may not be the best or preferred one to select; i.e., tall fescue is preferred over orchardgrass, or common Bermuda over Coastal Bermuda on critical areas, etc.
3. Fall seeding is more successful than spring seeding in the Coastal Plain and Piedmont. Ladino clover is included in the recommendations for White Clover.
4. Pensacola is limited to southeastern Coastal Plain. Wilmington is adapted to all of the Coastal Plain.
7. Instead of sprigging, the area may be covered with 3" or more of soil containing ample sprigs.
11. The design capacity shall be increased by an amount equal to that which sericea reduces the volume flow.

12. Limited to southeastern Coastal Plain.

STAGGERED CUT METHOD

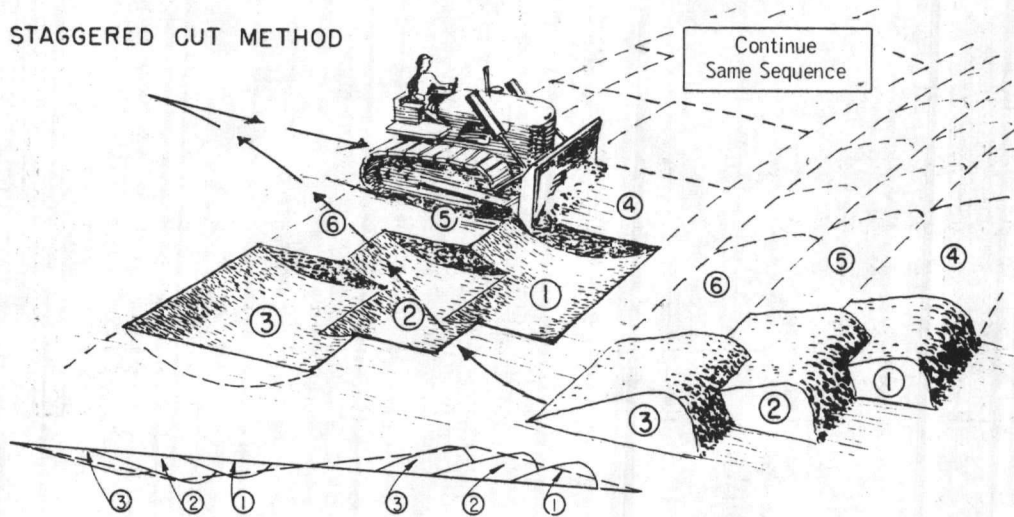

STRAIGHT CUT METHOD

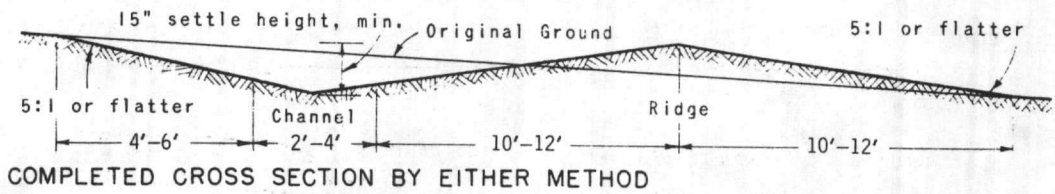
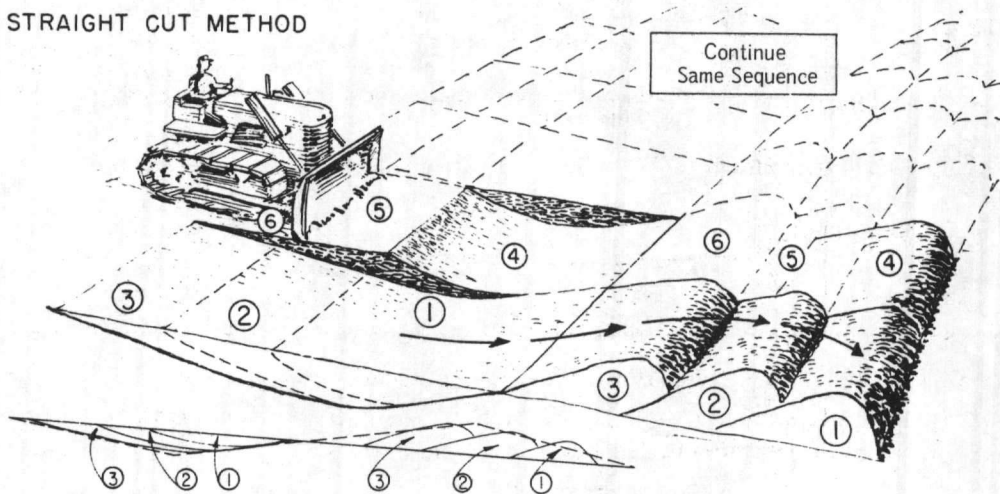

DIVERSION CONSTRUCTION WITH A BULLDOZER



X. GROIN SYSTEM

TYPICAL PLAN

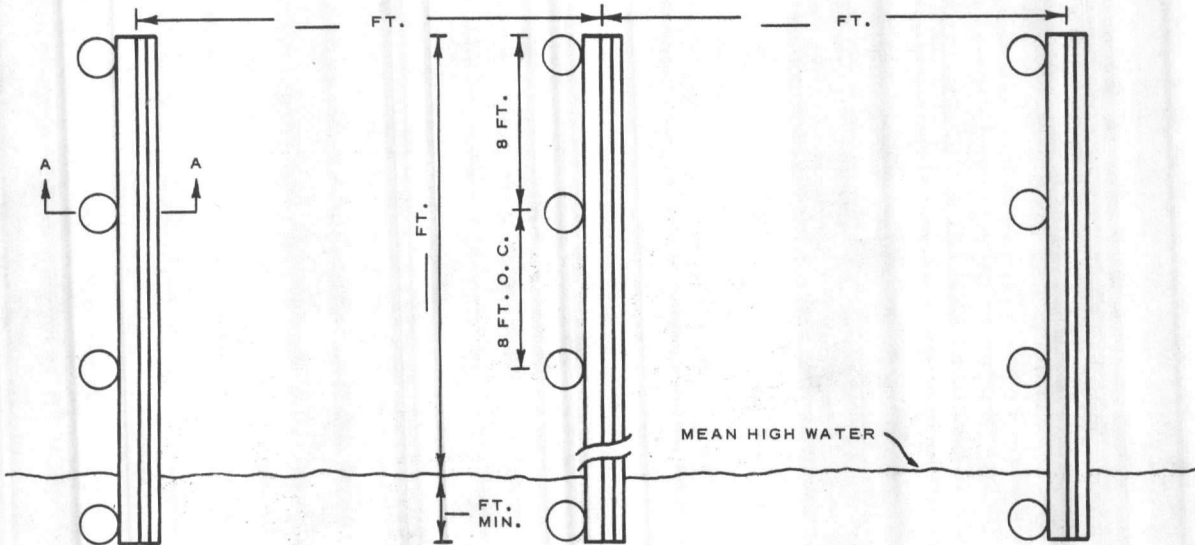

SECTION A-A

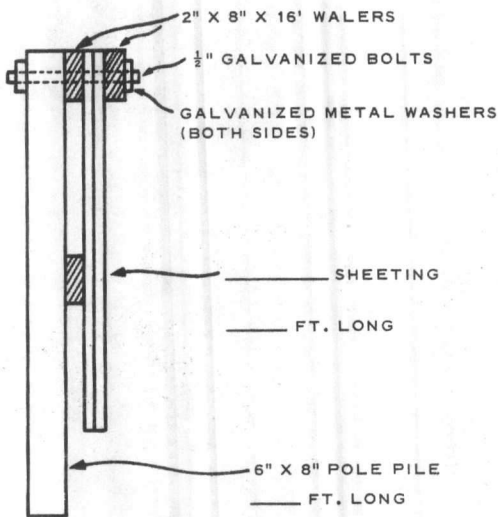

NOTE:

\_\_\_\_\_ GROINS WILL BE INSTALLED  
 ORIGINALLY, AS THESE FILL \_\_\_\_\_  
 ADDITIONAL GROINS WILL BE INSTALLED

ELEVATION

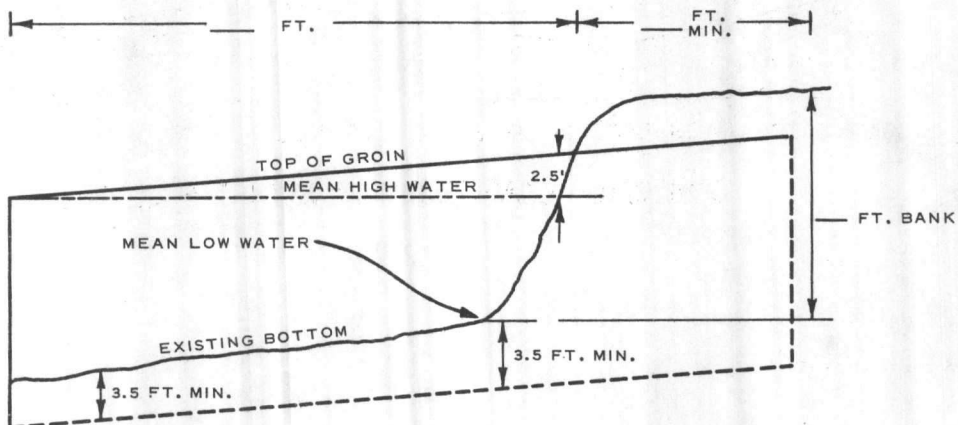

# SHORE EROSION CONTROL BULKHEAD SYSTEM PLAN VIEW

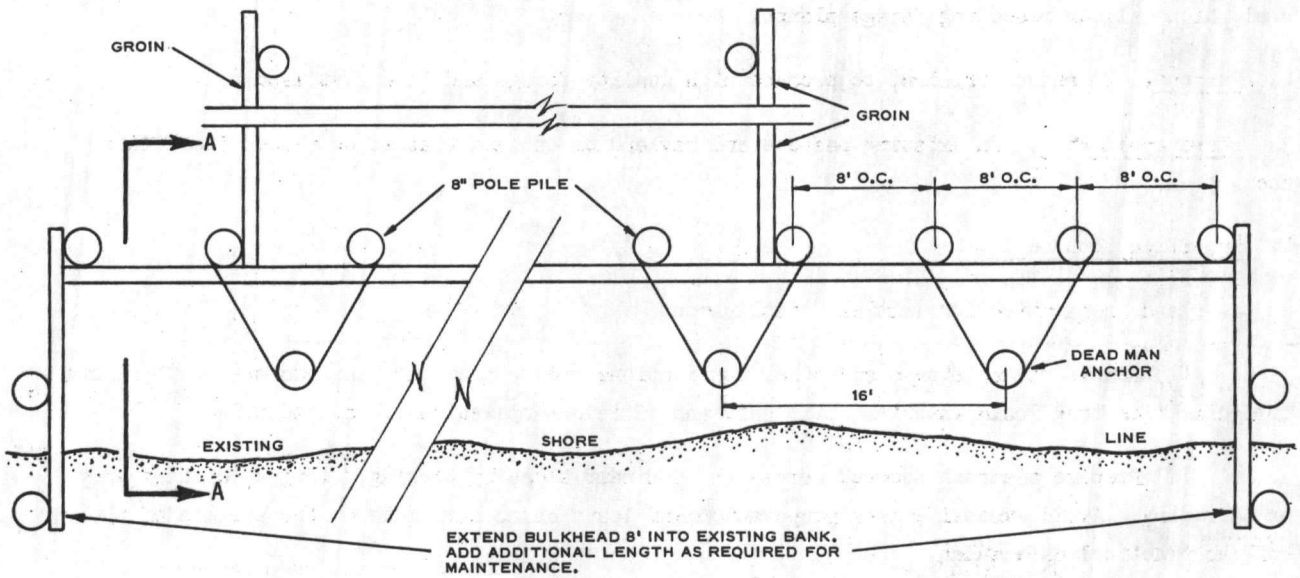

## SECTION A-A

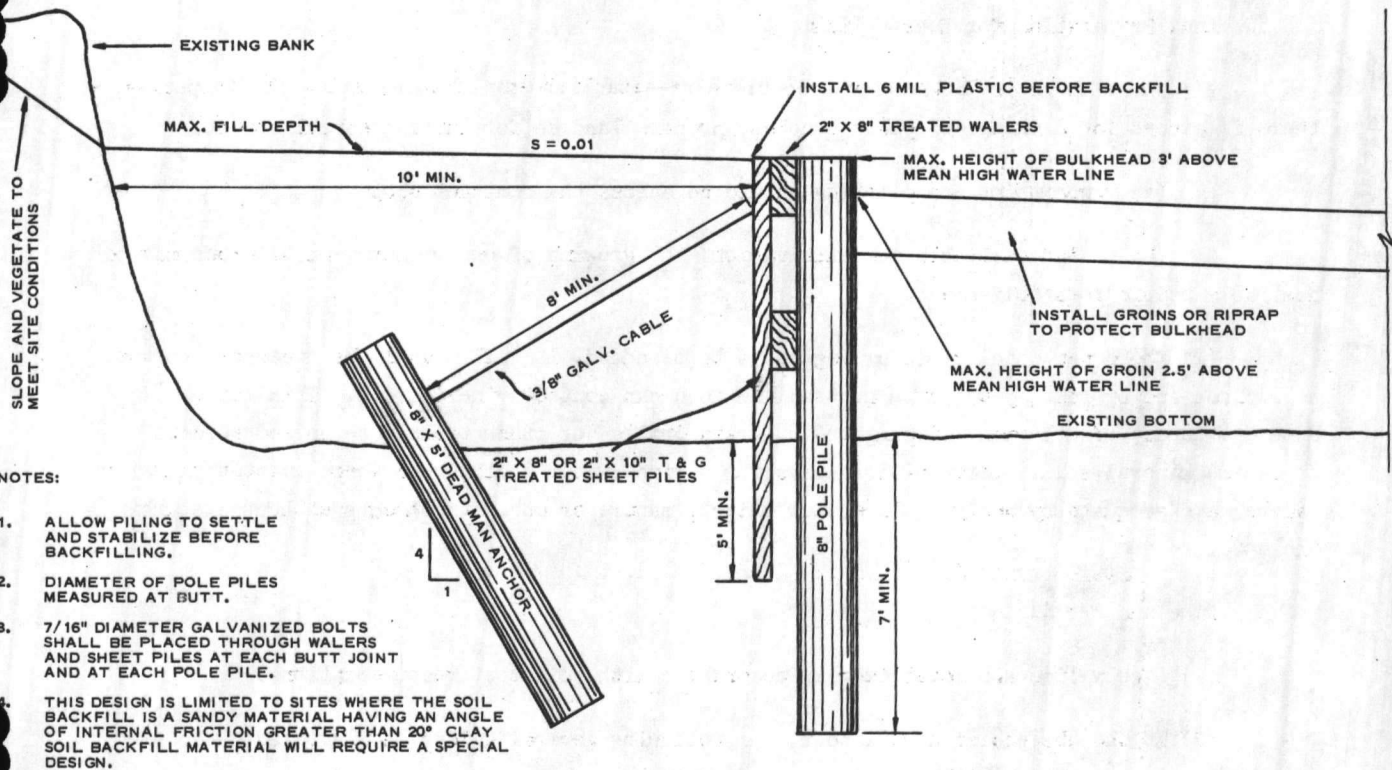

Y. PASTURE AND HAYLAND PLANTING (Ac.)

1. Definition. Establishing and re-establishing long-term stands of adapted species of perennial, biennial, or reseeding forage plants.

2. Purpose. To reduce erosion, to produce high quality forage and to adjust land use.

3. Where Applicable. On existing pasture and hayland or on land that is converted from other uses.

4. Specifications Guide

a. Land Preparation for Initial Establishment

(1) Remove rocks, stumps and other obstructions and do necessary land smoothing to remove irregularities that would interfere with safe and efficient operation of equipment.

(2) Prepare a smooth seedbed across the dominant slope by turning, ripping, disking and/or harrowing. Avoid excessive land preparation and leave as much residue on the surface of the soil as practical as a mulch.

(3) Apply the needed lime and a portion of the prosphate several months before seeding or sprigging, for best results, and work into the soil.

b. Land Preparation for Reestablishment

(1) Where there is a need for a complete re-establishment of an existing plant species, or there is a need for a change of plant species, prepare land as for initial establishment.

(a) Preparation and planting should be across the dominant slope.

(b) On land suitable for cultivation, the growing of one or more annual crops may be desirable before reestablishment.

(2) Where perennial grass or legume is to be added, it will usually be necessary to use herbicides and/or scarify the area so that the seed can contact mineral soil. This may be done by the use of a harrow, ripping tools, grain drills, or other tools such as sod seeders to expose mineral soil. Leave drainageways for surface water undisturbed where vegetation is or can be made adequate by applying lime, fertilizer, manure or other treatments without disturbing the soil.

c. Lime and Fertilizer

(1) Apply lime and fertilizer in accordance with soil test recommendations.

(2) In the absence of a soil test, the following general guides should be adjusted for specific soil and site conditions.

(a) Clover-Grass - 1 to 2 tons lime, 800 to 1,000 pounds 2-12-12 plus 500 to 1,000 pounds superphosphate on soils low in phosphorus and 150 to 250 pounds muriate of potash per acre on soils low in potash.

(b) Clover Alone - 1 to 2 tons lime, 800 to 1,000 pounds 2-12-12 plus 500 to 1,000 pounds superphosphate on soils low in phosphorus and 150 to 250 pounds muriate of potash per in midsummer of first growing season on soils low in potash.

(c) Grass Alone - (except Coastal Bermuda) 1 to 2 tons lime, 600 to 800 pounds 8-8-8, 5-10-10 per acre (or 0-14-14, 0-10-20 or 0-25-25 plus 40 to 60 pounds N per acre when growth starts).

(d) Coastal Bermuda - 1 to 1.5 tons lime, 300 to 500 pounds 0-10-20 on sandy soils or 0-14-14 per acre on clay soils, plus 30 to 50 pounds of N per acre when growth starts. Use 400 to 600 pounds 5-10-10, 10-10-10 or 10-20-20 per acre on fields where crabgrass and weeds are not a problem. Apply an additional 60 to 100 pounds N in midsummer.

(e) Sericea and Kudzu - 1 to 2 tons lime and 400 to 800 pounds 2-12-12, 0-14-14 or 0-10-20 per acre.

d. Seeding or Sprigging

(1) Consider climate, soil resources available, season of growth of plants and forage needs of the enterprise when selecting plant(s) or mixture(s). Refer to the attached table for some commonly used perennial forage plants.

(2) Inoculate legumes where needed. Follow instructions on the container.

(3) Seed on a firm seedbed and cover from 1/2 to 1 inch deep depending on the size of the seed and firm the soil.

(4) For row or broadcast planting of Bermudagrass sprigs, cover two to three inches deep and firm the soil over the sprigs.

e. Other Considerations

(1) Control weeds as needed before, at, or after planting or renovating by: (a) applying chemicals in accordance with current N. C. State University's pesticide manual, and (b) mowing and/or controlled grazing. Caution: Pesticides are dangerous. Use only as directed and heed all precautions on the container label. Check the registration number and be sure that the directions for use include the target pests. Drift from aerial spraying can contaminate nearby crops and forage, lakes and reservoirs. Improper use and careless disposal of unused portions can lead to poisoning of humans, domestic animals, desirable plants, pollinating insects, fish and wildlife and can contaminate water supplies.

(2) Delay grazing until: (a) tall-growing plants have reached a height of 6 to 8 inches tall and (b) sod-forming or spreading type plants have covered the ground.

Table 18.

COMMONLY USED FORAGE PLANTS AND MIXTURES  
SEEDING RATES AND DATES

	PLANTING RATES/AC $\frac{1}{2}$ /	PLANTING DATES	NOTES
1. Tall Fescue	15-25	Sep - Nov	Not well suited to infertile droughty, sandy soils - requires good maintenance.
2. Tall Fescue and Ladino Clover	8-10  2-4	Sep - Nov	Best on moist fertile soils not suited to infertile, droughty sandy soils.
3. Orchardgrass	15-25	Sep - Nov	May be used on well drained soils.
4. Coastal Bermudagrass In Rows Broadcast	10-15 bu. or 15-20 cu. ft 40-60 bu. or 50-75 cu. ft.	March - April 15	Use freshly dug moist sprigs, plant in moist soil and keep free of competition.
5. Pensacola Bahagrass	20-30	Mar 15 - Jun 15	
6. Wilmington Bahagrass	25-35	Mar 15 - Jun 15	
7. Sericea Lespedeza (scarified)	20-40	March - May	Avoid wet sites. May be grown on droughty deep sands and eroded areas where other forages are not well suited.
8. Sericea Lespedeza (Unscarified)	50-60	Oct - Feb	May be seeded alone or overseeded on fescue small grain & other compatible plants during fall & winter months.
9. Sericea Lespedeza (Scarified) & Bahagrass	15-20  10-15	March - May	
10. Ladino Clover	4-6	Sep - Oct 15	Not suited to infertile droughty sandy soils

NOTE: These are rates for complete seeding. Judgment should be used in arriving at rates when partial seeding is made to reestablish or reinforce a stand.

Z.

PASTURE AND HAYLAND MANAGEMENT (Ac.)

1. Definition. Proper treatment and use of pastureland or hayland.
2. Purpose. To prolong life of desirable forage species; to maintain or improve the quality and quantity of forage; and to protect the soil, and reduce water loss.
3. Where Applicable. On all pastureland to hayland.
4. Specification Guide.

a. Pasture Land

(1) Proper Use

(a) The minimum height to begin and stop grazing pasture plants are given in Table 19. These heights can usually be maintained only with two or more separate grazing areas of each cool and warm season perennial, supplemented with annual grazing plants, hay or silage.

(b) Where livestock must remain on the same pasture for the entire grazing season, the stocking rate shall be such as not to adversely affect the stand and vigor of desirable and dominant plant species.

(c) Move livestock in the hot dry summer month from cool season to warm season forages, or reduce the stocking rate to maintain the optimum height indicated in Table 19.

(d) Allow forage not needed for grazing to accumulate for later grazing or harvest for hay or silage; or allow to mature and harvest for seed. Most tall-growing perennial grasses and legumes are benefited by rotation grazing to permit recovery of plants.

(e) Rotation Grazing:

1. Plan rotational grazing by dividing pasture into 2 or more grazing units so that a portion of the pasture can be "rested" while the other is being grazed. The number and size of grazing units will be determined by the stocking rates, plants, etc.

2. Move livestock when the minimum heights as shown in Table 19 are reached.

3. The stocking rate and days required for regrowth will vary with plants, seasons, moisture, temperature, fertility level, and the number and acres of pasture in the grazing system.

(f) Annual forage plants (hay, silage or grain) may be needed to supplement perennial pasture plants.

TABLE 19 - USE HEIGHT AND GRAZING SEASON

Plant Commonly Grown	Grazing Season	Optimum Height Inches to	
		Start Grazing	Stop Grazing
Bahiagrass	April to October	5	2
Bermudagrass Common	May to October	4	2
Coastal Bermudagrass	April to October	5	2
Tall Fescuegrass	March to June September to December	6	3
Orchardgrass	March to June September to November	6	3
Ladino Clover	March to June September to November	5	3
Kudzu	May to October	Full Leaf Cover	$\frac{1}{2}$ Leaf Cover
Sericea Lespedeza	May to October	7	4

## (2) Other Considerations for Management:

(a) Interplanting - Where desired, seed cool-season annuals (small grain, etc.) in warm season perennials (Bermudagrass, Bahiagrass, Sericea Lespedeza, etc.). Mow or graze pastures down to specified minimum grazing height or suppress grass with chemicals before seeding.

1. Seed 2 bushels rye, 4 bushels oats, 3 bushels barley, 3 bushels wheat, 25 pounds vetch, 30 pounds ryegrass, 30 pounds Crimson clover, or a mixture of above about 2 weeks before the first normal frost date.

2. Use grassland drills, minimum tillage planters or similar equipment. Space drills or rows not less than 16 inches apart. Where broadcast seeded, scarify the soil surface lightly by disking, ripping, etc., before seeding.

3. Fertilize legumes with 400-600 pounds 0-10-20 and grasses with 400-600 pounds of 10-10-10 per acre at time of seeding. Topdress grasses with 50 to 100 pounds N per acre.

4. Graze the interplanted crop closely in the spring to avoid suppressing the warm season perennial.

5. Do NOT overseed same areas every year. Follow a 2 or 3 year rotation to avoid damage to the perennial and to reduce weed problems.

(b) Water - Consider the need for a supply of clean water and the required fencing when planning for all grazing areas.

(c) Fencing - Plan for fences needed to separate different kinds of plants and to provide for their proper use (cool season, warm season, temporary grazing crops).

(d) Shelter and Shade - Provide needed shade and shelter. This can usually be planned in connection with rest, salting and watering areas.

(e) Clipping - Clip before plants become unpalatable or tough, or when growth becomes uneven due to spot grazing, or when pasture becomes infested with weeds.

(f) Weed and Brush control—mow and/or use chemicals. When chemicals, follow N. C. State University current recommendations and adhere strictly to manufacturer's instructions. Caution: Read the label and follow instructions and precautions of the manufacturer. If herbicides are handled or applied improperly, or if unused portions are not disposed of safely, they may injure humans, domestic animals, desirable plants, and fish or other wildlife and may contaminate nearby crops and other vegetation. Follow the directions and heed all precautions on the container label. Herbicides should not be used over or directly adjacent to ponds, lakes or streams.

### (3) Maintenance

(a) Fertilization - Apply lime and fertilizer in accordance with one of the following: (1) soil test recommendations, (2) current N. C. Experiment Station recommendations, (3) knowledge of the soil, past history of the field and the nutrient requirements of the plants to be grown, or (4) as indicated below.

1. Legume-grass: Stands with about 50% each grass and legume, fertilize with 400 to 800 pounds 0-14-14, 0-10-20, or 0-9-27, depending upon P or K needed. Apply 1 to 2 tons of lime each 3 to 5 years. Stands with about 80% or more of clover, treat as clover alone. Stands with about 80% or more of grass, treat as grass alone.

2. Grass alone: Apply 400 to 800 pounds 0-10-20, 10-20-20 or 10-10-10 plus 60 to 200 pounds N in split applications. Apply 1 to 1.5 tons lime each 3 to 5 years.

3. Legumes alone: Apply 400 to 800 pounds 0-14-14, 0-10-20 or 0-9-27, depending upon K and P needs. Apply 1 to 2 tons lime each 3 to 5 years.

(b) Apply fertilizer on warm season perennials in the spring just before growth starts and on cool-season perennials in fall or early spring.

(c) Topdress grasses with N at the time stock is moved to other grazing areas in the rotation and after cutting hay, except the last cutting.

(d) Heavy application of ammonium nitrate will require increased use of lime to maintain desirable pH of the soil.

#### b. Hayland

(1) Harvesting - See Table 20.



TABLE 20

Species	Plant Growth Stage or Height to Cut	Cut No Lower Than (Inches)
Bermudagrass Coastal	10-12" high <u>1/</u>	2
Common Bermudagrass	10"	2
Orchardgrass & Tall Fescue	Boot Stage and after 10"-12" recovery growth	3
Bahiagrass	10" or 1/10 bloom	2
Grass-legume mixture	When grass is ready	3
Kudzu	18" to 24" high	6
Annual Lespedeza	Early bloom or when lower leaves start shedding	3
Sericea Lespedeza <u>2/</u>	10" to 12" high - cut in a.m., rake same p.m.	4

1/ Cutting at 10-12 inches improves quality and reduces quantity. Cutting higher than 12" gives an increase in quantity and lower quality hay. Cut when first seed heads appear, regardless of height. Cut at least every five weeks.

2/ Make last cutting in time to allow 6" to 10" regrowth before frost.

(2) Maintenance

(a) The fertilization for hay and pasture land is the same, except higher rates of nitrogen (300 pounds) can be more profitably used on Coastal and Midland Bermudagrass for hay.

(b) Remove heavy residue of previous year's growth of Bermudagrass before new growth starts.

AA.

FISH POND MANAGEMENT

1. Definition. Developing or improving impounded water to produce fish for domestic use or recreation.

2. Purpose. To improve or maintain fish production and fishery use by making a favorable water habitat; supplementing natural food supplies; and reducing competition from unwanted plants and animals.

3. Where applicable. In ponds, lakes and reservoirs where a crop of fish is wanted.

4. Specifications Guide.

a. Construction. Proper construction is essential in establishing and maintaining a pond management program. Some points to consider when constructing ponds for fish production are as follows:

(1) Install bottom water release. See attached.

(2) Minimum edge depth of 2 feet. Exceptions to this would be at small areas where water enters the pond, and at the emergency spillway.

(3) Design spillway such that maximum water release will not exceed 4-5 inch depth.

(4) Delay filling new ponds as long as possible prior to stocking. If possible, pond should be filled after first frost.

(5) Specialized pond design will be needed for commercial fish production.

(6) Where large volumes of water are present, design criteria should include measures to divert excess water. This water can be diverted around the pond or carried through the pond by use of a bottom water release.

(7) Construct ponds on soils rated suitable for impounded ponds.

b. Stocking

(1) Bass, Bluegill and Redear Sunfish - For unfertilized (natural fertility) ponds, stock 500 bluegills with or without 10-30 percent redear sunfish and 50 bass per acre. (Rates are for fingerling stocking only.) Double these rates if a fertilization program is to be followed.

(2) Carp, Israelian - Pending approval from the N. C. Wildlife Resources Commission for the use of these fish in this state, stock 50 five to six inch fingerlings per acre in unfertilized waters. Double this rate if the owner is carrying out a full fertilization program.

(3) Catfish, Channel - For ponds exclusively devoted to this species, stock 1,500 to 2,000 four to five inch channel catfish fingerlings per acre in February or March. At the same time, 1,000 fathead minnows may be added per acre. In May or June, stock 100 bass fingerlings per acre. This type of stocking necessitates feeding (see Channel Catfish guide for data).

c. Fertilization

(1) Bass-Bluegill-Redear Sunfish-Catfish Combinations

(a) Important in preventing waterweed growth and for insuring adequate food organisms for maximum fish production. New ponds should usually be fertilized two weeks before fall stocking. Apply two applications two weeks apart.

(b) Season to fertilize: February through October.

(c) Amount to fertilize:

1. 100 pounds of 8-8-2, 40 pounds of 20-20-5 or equivalent amounts per acre per application. Repeat the applications at 7 to 10 day intervals until the color of the water prevents sight of a white object held 12-18 inches beneath the surface. Subsequent applications will be needed only when a white object can be seen at a depth of 18 inches.

2. In older ponds (3-5 years and up) which have been properly fertilized since stocking, 40 pounds of superphosphate (18 pounds of triple superphosphate) can be used in place of the fertilizer listed above. Phosphate fertilization produces satisfactory results and reduces fertilization costs by approximately two-thirds. Time and frequency of application should be the same as described above.

(d) Method of application

1. Use fertilizer platform. A typical platform design is attached. One platform per 15 acres of surface water is sufficient. Place bag of fertilizer on platform and tear open the bag. Fertilizer will dissolve and be distributed over the pond by water currents.

2. Fertilizer can be scattered around the edge of the pond or distributed by boat. If applied in this manner, however, it should not be put in water over 5 feet deep. Fertilizing by this method generally produces less desirable results than the platform method.

(2) Liming

(a) The use of lime has been successful in producing blooms in ponds that have not responded to fertilization. This has been particularly true in ponds having a "borderline" acidity; i.e., pH range of 5-6.5.

(b) Two types of lime can be used—ground agricultural lime and hydrated lime. The former should be used at a rate of 1,000-2,000 pounds per acre and will give 2-5 years benefit. The latter should be used at not more than 50 pounds per acre. If excessive amounts of hydrated lime are used, a fish kill may result due to an extremely rapid change in the pH of the pond water. An application of 50 pounds of hydrated lime per acre should last for approximately one year.

(c) Most extremely acid ponds (pH range 2.5-4.5) are of the excavated type. If these are to be managed for fish production, the spoil should be spread, limed and seeded. A low dike should be constructed around the pond to prevent surface water entrance. One ton of lime should then be added to the pond with subsequent applications added until the pH range is 6.0 or above. Very acid pond will need the pH checked every 18 months to two years to see if additional lime is needed.

d. Population Control

(1) Fish toxicants

(a) Remove all wild fish or unbalanced populations before stocking. To do this, drain the pond to its lowest level and add 3 pounds of 5 percent rotenone dust or two pints of emulsified form of rotenone per acre-foot of water.

(b) Do not treat a pond after September unless the weather has been very warm; then to be safe, double the quantities used.

(c) In ponds that cannot be drawn down to less than four feet, ponds with spring beds in the bottom, or ones that have marshy areas on the edge, a complete kill is very difficult to obtain.

(d) North Carolina law forbids the use of rotenone for killing fish except when a member of the North Carolina Wildlife Resources Commission is present. Inform any one planning to eradicate fish with toxicants of this law, and encourage them to contact the local wildlife commission representative.

(e) Note: USDA has registered rotenone as a fish toxicant; however fish killed with rotenone should not be consumed by man or other animals.

(2) Fishing the pond

(a) Do not fish the pond until the bass have spawned successfully. The pond should be seined in June or July to determine this.

(b) When the pond is opened to fishing for the first time, approximately 70 percent of the fish population is of catchable size. Care should be taken not to overfish during this period. During the first year of fishing, 15-20 pounds of bass can be harvested per acre. Bluegill harvest should be at a rate of 4-6 pounds per pound of bass.

(c) Catfish should be stocked every third year since reproduction of these species in ponds is limited. When stocked in ponds having a resident population of adult bass, catfish should be at least 10 inches long.

e. Feeding

(1) Channel Catfish - This species is fed a commercially prepared, high-protein diet. Feeding should be carried out when the water temperature is between 60° F and 88° F. At temperatures outside this range, feeding should be reduced or terminated. Feed should be

placed in the pond at approximately the same spot each day. In ponds stocked with 4-6 inch fingerlings, one feeding per day is sufficient.

(2) The correct amounts to feed are governed by fish size and water temperature. Feed 3 percent of the body weight per day; i.e., 3 pounds per 100 pounds of fish. Below is a chart giving a first-year feeding schedule based on a stocking of 1,5000 six-inch fingerling per acre. It is presented only as a guide, since judgment must always be used when feeding fish.

<u>Period</u>	<u>Feed/Acre</u>	<u>Feed/Acre</u>
	<u>Per Day - Lbs</u>	<u>Per Acre - Lbs</u>
March 1-15	3	45
March 16-31	5	80
April 1-30	8	240
May 1-31	10	310
June 1-30	13	390
July 1-31	15	465
August 1-31	17	517
September 1-30	20	600
October 1-31	25	<u>775</u>
		3,422

Note: Second-year feed amounts will be variable, depending upon number (weight) of fish harvested.

f. Parasites and diseases

(1) Farm Ponds - Problems with parasites and/or disease usually occur only when the fish population becomes overcrowded or when some other unhealthy condition exists; i.e., pollution, high water temperatures and low water, etc. Treatment in ponds is usually not practical. Type parasites will dictate courses of action and assistance should be requested from SCS biologist, NCWRC biologist, or USFWS biologist (hatchery manager) when problems arise.

(2) Catfish ponds - Potential disease outbreaks represent a major hazard. Early diagnosis and quick treatment are essential. To this end, the following symptoms are listed:

- (a) Fish "going off" feed.
- (b) Lesions or red areas around the fins or on the body.
- (c) Crowding water supplies.
- (d) Swimming listlessly at the surface of the water.
- (e) Unexplained or sudden increase in mortality.

(3) When disease symptoms occur, a qualified disease biologist should be contacted immediately. In North Carolina, contact the following: Mr. Jimmy Camper, Fisheries Biologist,

Pisgah Forest National Fish Hatchery, P.O. Box 158, Pisgah Forest, N. C. 28768; or Mr. Martin Sullivan, State Fish Hatchery, Marion, N. C. (Telephone 704-756-4179).

(4) Note: Improper treatment or treatment with drugs not cleared by the Food and Drug Administration could lead to the condemnation of fish. Before chemicals are used, advice should be obtained from one of the above.

g. Aquatic Weed Control

(1) Chemical

(a) At present, copper sulfate is the only herbicide having clearance for use in waters from which fish will be taken for human consumption. Copper sulfate is effective in controlling single filament algae and chara (stonewort).

(b) Many chemicals have USDA clearance for use in water. However, these chemicals must also receive Food and Drug Administration clearance if they are to be used in fish culture and management. Pond owners should be aware of this fact and advised to carefully read product labels before making decisions to use chemicals.

(2) Biological and mechanical

(a) Prevention of weed occurrence through proper pond construction and management is the best practical method of aquatic weed control. If practices discussed in these specifications are adhered to, waterweeds will not, in most cases, be a serious problem. Deepened edges and proper fertilization are essential in waterweed control.

(b) Israeli carp have proven to be successful in controlling branched and single filament algae.

(c) Various mechanical cutters are used for weed control. A program of this type can be successful if repeated often enough. The emergent rooted aquatics are most susceptible to treatment of this type.

5. Trickle Tube - Bottom Water Overflow

a. To be used for pond management, to aid in control of water temperature, improve efficiency of fertilizer and in the management of streams below ponds. It has special significance on:

(1) Borderline ponds (neither cold nor warm water) - Remove cold water from pond bottom.

(2) Warm-water ponds, especially those which have large watershed - This will enable the pond owner to carry out a better management program.

b. The bottom water overflow is the best type of overflow for use in most ponds. It is essential for efficiency in management of many ponds.

c. Drawings on the following pages illustrates essential features for design and installation.

# TRICKLE TUBE WITH FLOW TAKEN FROM BOTTOM WATERS

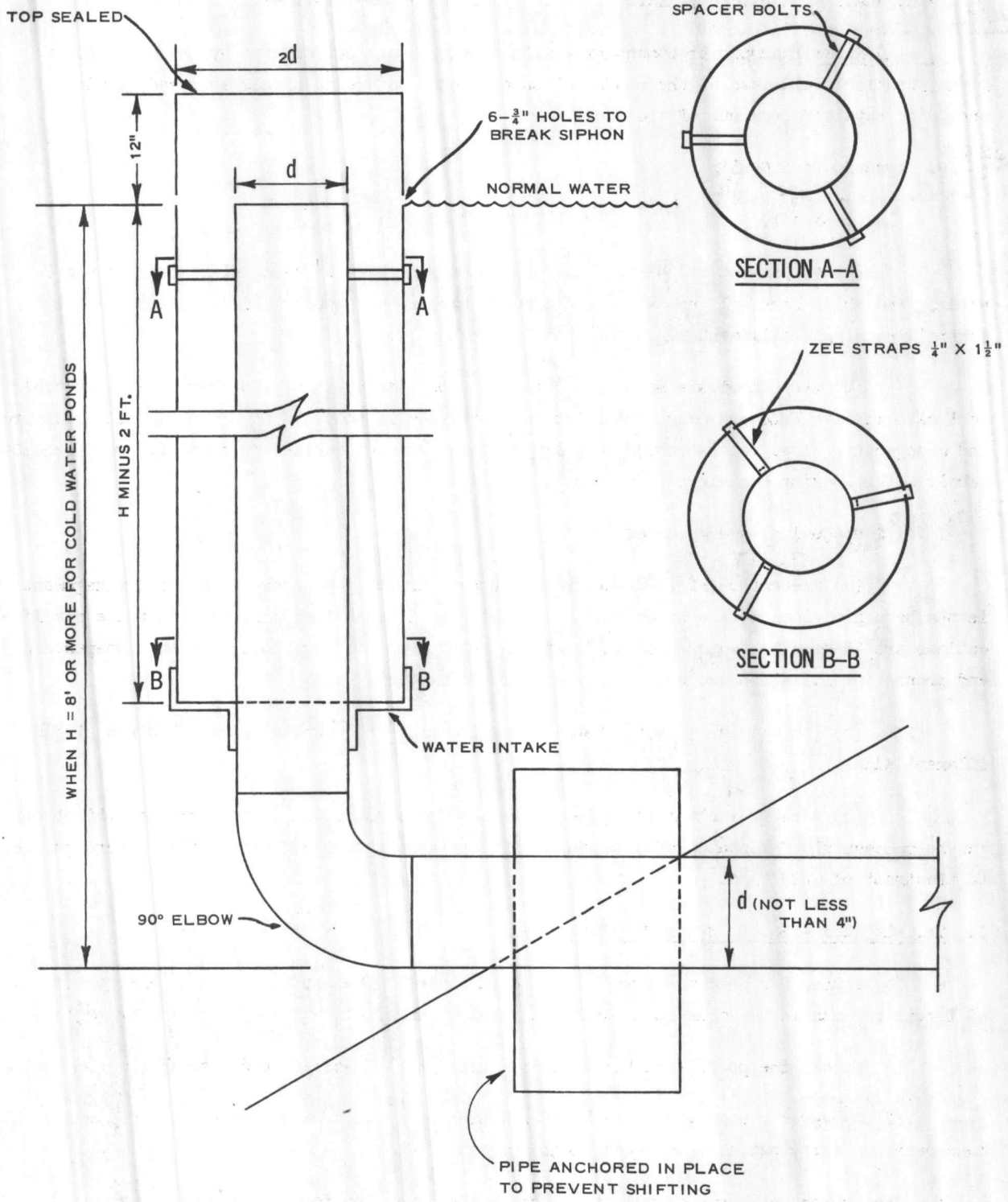

# METHODS OF FERTILIZER PLACEMENT IN PONDS

Three ways of placing fertilizer in ponds.

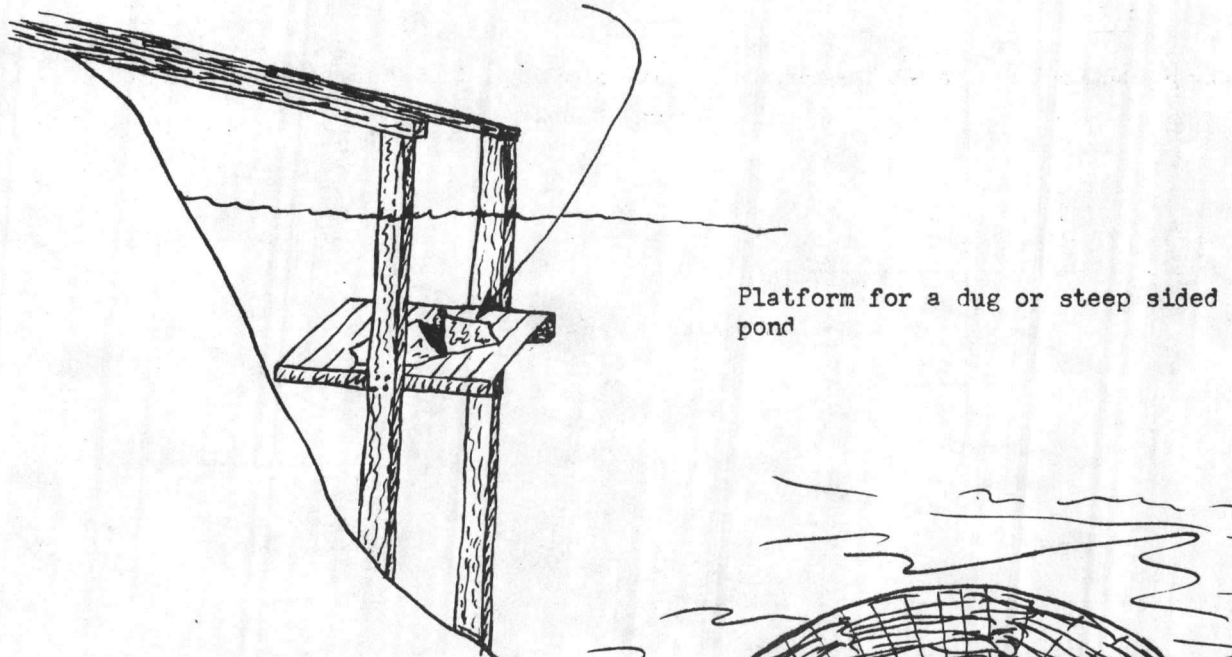
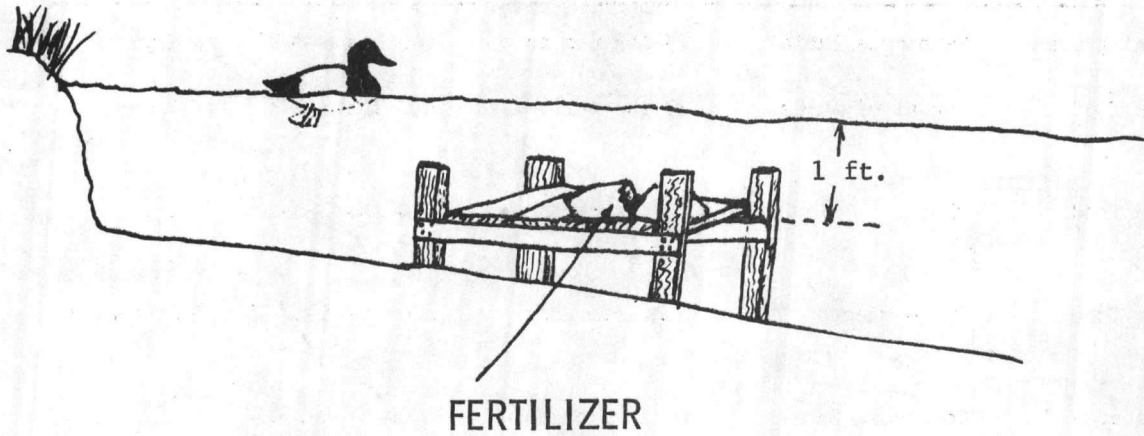

Burlap covered inner tube with fertilizer in a pocket

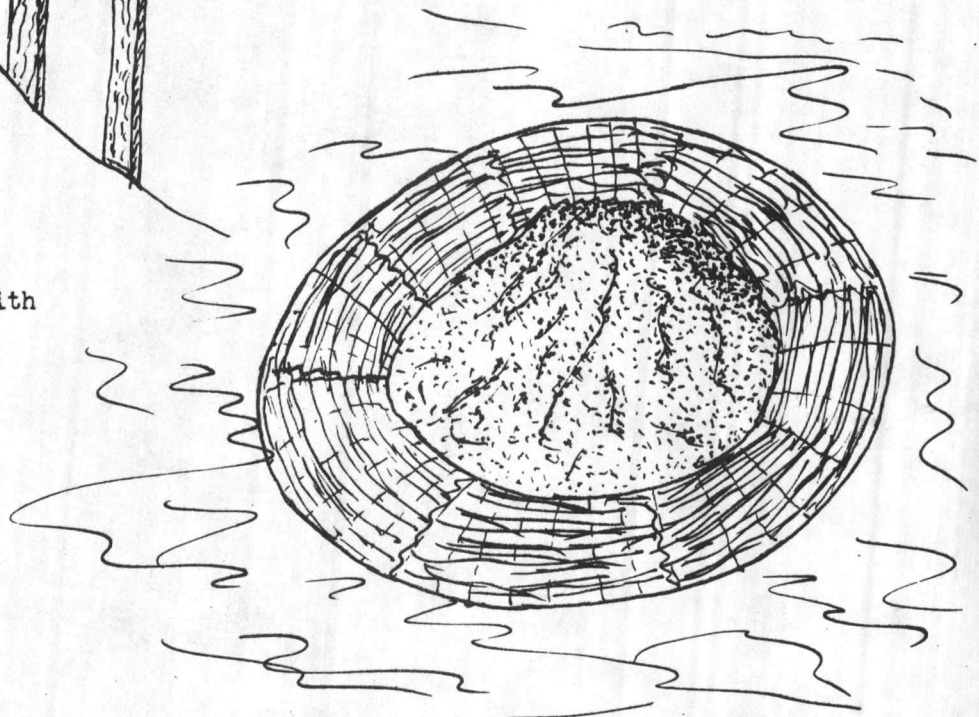



BB.

## SEEDING RATES FOR WILDLIFE PLANTINGS

TABLE 21

Type of Planting	Planting Material	Seeding Rate	Annual Fertilization	Schedule
Perennial grass	Pennscola Bahia	25 lbs per acre	400 lbs 8-8-8	May
Wildlife food plots	Annual mixtures	30 lbs per acre	400 lbs 8-8-8	June
Wildlife food plots	Chufas	20 lbs per acre	500 lbs 8-8-8	May
Wildlife food plots	Rye - Wheat	2 bu per acre	400 lbs 5-10-10	September
Forest access roads	Pennscola Bahia	30 lbs per acre	400 lbs 8-8-8	March
Shrub plantings	Va.-70 Lespedeza	1,000 seedlings per 1/8 acre	500 lbs 8-8-8	March

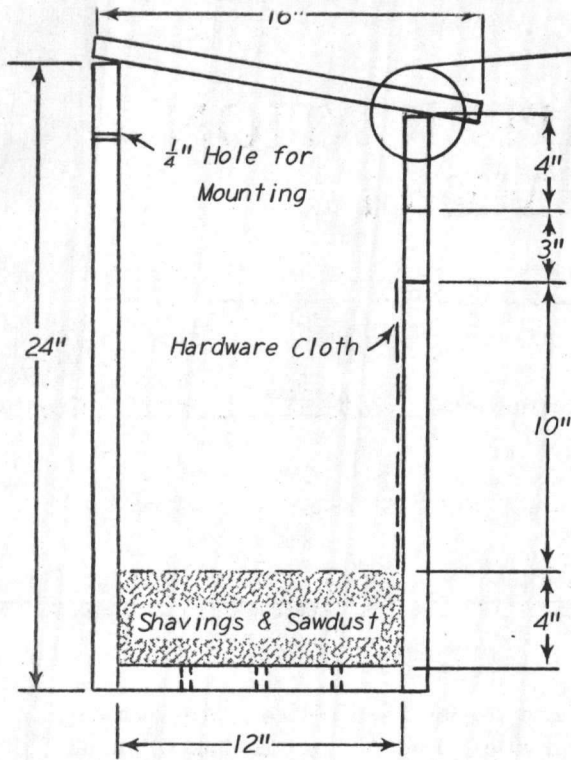

SECTION ALONG C-C

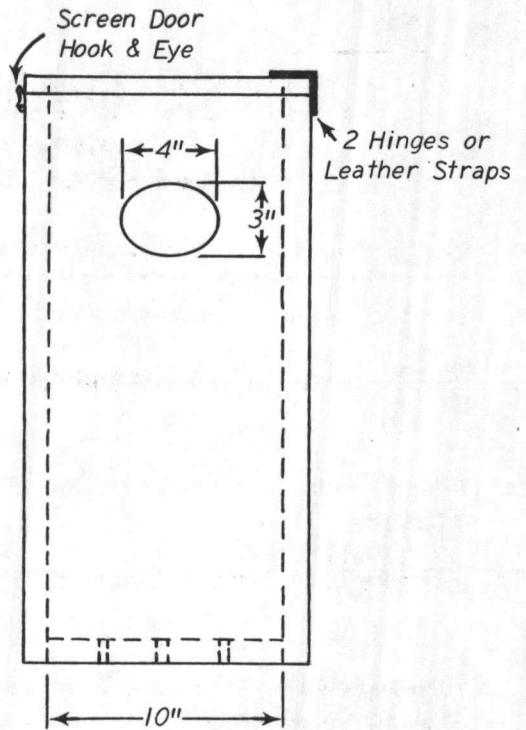

FRONT VIEW

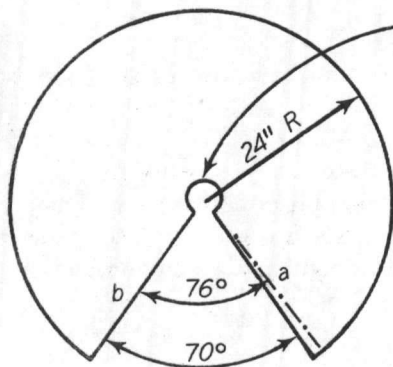

PREDATOR GUARD

Diameter of Post (in.)	Diameter of Hole (in.)
3	4.5
4	5.7
5	7.0
6	8.2
7	9.4
8	10.7
9	11.9
10	13.1
11	14.4
12	15.6

After Cuts Are Made  
Let a Overlap b to Snugly  
Fit Post or Tree & Fasten  
with Sheet Metal Screws

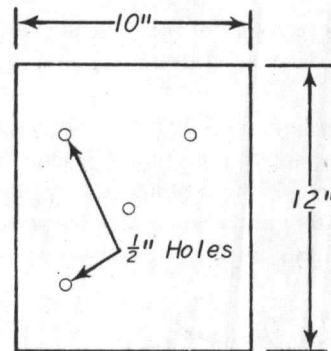

PLAN VIEW OF BOTTOM

**MATERIALS:**

- 1" x 12" x 10" Rough Cypress, Redwood or Treated Pine
- 2" Screen Door Hook & Eye
- 2 Small Hinges or Leather Straps
- 12" x 4" x 1/4" Mesh Hardware Cloth
- Shavings & Sawdust As Shown
- 1 Piece 4'-0" x 4'-0" Sheet Metal
- 4 Sheet Metal Screws

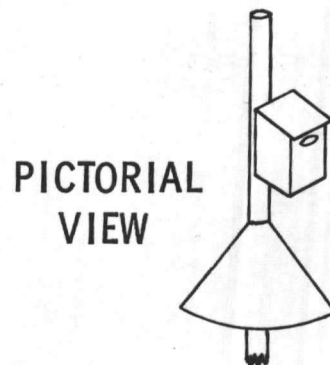

WOOD DUCK NESTING BOX

# CONSERVATION APPLICATION AND AGREEMENT

*Between*

Onslow \_\_\_\_\_ Soil and Water Conservation District, \_\_\_\_\_ Onslow \_\_\_\_\_ County

*And*

Marine Corps Base  
(OWNER OR OPERATOR)

Camp Lejeune, N. C.  
(ADDRESS)

\_\_\_\_\_  
(AGREEMENT  
NUMBER)

112,459  
(ACRES)

I request help from my Soil and Water Conservation District in developing a soil and water conservation plan for my land, such plan to meet the requirements of any watershed activities. I intend to use my land within its capabilities and treat it according to its needs, and will cooperate in making the land use adjustments and in applying and maintaining the conservation practices that I plan. I will use any materials furnished by the District as indicated in my conservation plan.

We, the Supervisors of the District, will furnish technical assistance, materials and supplies as available to help plan, apply, and maintain the needed soil and water conservation measures.

It is mutually agreed that: (1) Neither the District, its representatives, nor the owner or operator will be liable for any damage to the other's property or personal injury resulting from the planning or carrying out of the soil and water conservation plan, unless such damages are caused by negligence or misconduct. (2) This agreement will remain in effect until terminated by change of ownership or operator or by either party giving sixty (60) days written notice to the other.

*R. D. Bohn*  
R. D. BOHN, MajGen USMC, Commanding  
(OWNER OR OPERATOR)

1 August 1974  
(DATE)

SOIL AND WATER CONSERVATION DISTRICT

BY *T. B. Humphrey*  
(SUPERVISOR)

20 Nov 74  
(DATE)



**INDEX TO SECTIONS**

**INTRODUCTION**

**GROUNDS MAINTENANCE**

**WILDLIFE**

**RECREATION**

**FORESTRY**

**APPENDIX**