

109TH CONGRESS }  
2d Session

COMMITTEE PRINT

{ S. PRT.  
109-45

**COMMITTEE STAFF REPORT TO  
THE CHAIRMAN AND RANKING MEMBER**

**REVIEW OF THE FDA'S APPROVAL PROCESS FOR  
THE VAGUS NERVE STIMULATION THERAPY  
SYSTEM FOR TREATMENT-RESISTANT DEPRESSION**

---

PREPARED BY THE STAFF OF THE  
COMMITTEE ON FINANCE  
UNITED STATES SENATE

CHARLES E. GRASSLEY, *Chairman*  
MAX BAUCUS, *Ranking Member*



FEBRUARY 2006

Printed for the use of the Committee on Finance

---

U.S. GOVERNMENT PRINTING OFFICE

24-711

WASHINGTON : 2006

COMMITTEE ON FINANCE

CHARLES E. GRASSLEY, Iowa, *Chairman*

ORRIN G. HATCH, Utah	MAX BAUCUS, Montana
TRENT LOTT, Mississippi	JOHN D. ROCKEFELLER IV, West Virginia
OLYMPIA J. SNOWE, Maine	KENT CONRAD, North Dakota
JON KYL, Arizona	JAMES M. JEFFORDS (I), Vermont
CRAIG THOMAS, Wyoming	JEFF BINGAMAN, New Mexico
RICK SANTORUM, Pennsylvania	JOHN F. KERRY, Massachusetts
BILL FRIST, Tennessee	BLANCHE L. LINCOLN, Arkansas
GORDON SMITH, Oregon	RON WYDEN, Oregon
JIM BUNNING, Kentucky	CHARLES E. SCHUMER, New York
MIKE CRAPO, Idaho	

KOLAN DAVIS, *Staff Director and Chief Counsel*  
RUSSELL SULLIVAN, *Democratic Staff Director*

# CONTENTS

---

	Page
I. Executive Summary .....	1
II. Introduction .....	3
III. Scope and Methodology .....	4
IV. Background .....	5
A. Vagus Nerve Stimulation Therapy System .....	5
B. Major Events Related to the Approval of the Vagus Nerve Stimulation Therapy System for Treatment-Resistant Depression .	6
C. Post-Approval Events .....	11
D. Summary of Cyberonics's Clinical Studies .....	12
V. Discussion .....	14
A. FDA Official Overruled Review Team: Device Approved Despite Team's Objections .....	14
B. FDA's Public Materials Do Not Reveal the Extent of Scientific Dissent Regarding Effectiveness of Device .....	17
C. Not All Relevant Findings and Conclusions Regarding Safety and Effectiveness of Device Were Made Publicly Available .....	24
VI. Concluding Observations .....	27
VII. List of Acronyms .....	31
VIII. Glossary .....	33
IX. Timeline of Major Events Related to Cyberonics's PMA-Supplement for the Vagus Nerve Stimulation Therapy System .....	37
X. Appendices .....	39
Appendix A—Chairman and Ranking Member Letters to the FDA .....	41
March 11, 2005 .....	42
April 19, 2005 .....	44
May 17, 2005 .....	47
May 27, 2005 .....	48
July 7, 2005 .....	49
July 28, 2005 .....	51
Appendix B—Approval and Labeling Information Posted on FDA's Website .....	55
Approval Order (July 15, 2005) .....	56
Summary of Safety and Effectiveness .....	63
Physician Labeling .....	85
Patient Labeling .....	123
CDRH Consumer Information on VNS Therapy System .....	152
Appendix C—FDA Regulations .....	155
21 C.F.R. § 10.70 .....	156
21 C.F.R. § 10.75 .....	157
21 C.F.R. § 812.36 .....	159
21 C.F.R. § 814.39 .....	162
21 C.F.R. § 814.42 .....	164
21 C.F.R. § 814.44 .....	165
21 C.F.R. § 814.45 .....	166
21 C.F.R. § 814.46 .....	167
21 C.F.R. § 814.47 .....	168
21 C.F.R. § 814.82 .....	169
21 C.F.R. § 860.7 .....	170

IV

	Page
Appendix D—Internal FDA Memoranda .....	175
Memoranda related to review of the sponsor's response to the FDA's August 11, 2004, not approvable letter:	
Division of General, Restorative, and Neurological Devices, CDRH (November 10, 2004) .....	176
Division of Neuropharmacological Drug Products, CDER (October 22, 2004) .....	186
Product Evaluation Branch II, Division of Postmarket Sur- veillance, CDRH (November 8, 2004) .....	188
Epidemiology Branch, Division of Postmarket Surveillance, CDRH (November 5, 2004) .....	195
Division of Biostatistics, CDRH (November 5, 2004) .....	198
Post-panel Meeting Memorandum (June 22, 2004) .....	202
Final Review Team Memorandum (January 6, 2005) .....	204
CDRH Director's Override Memorandum (June 12, 2005) .....	218
Appendix E—FDA Letters .....	239
Initial Review of PMA-S Letter (December 15, 2003) .....	240
Major Deficiency Letter (March 1, 2004) .....	243
Not Approvable Letter (August 11, 2004) .....	251
Warning Letter (December 22, 2004) .....	255
Approvable Letter (February 2, 2005) .....	264
Response to Chairman and Ranking Member's July 7, 2005, Letter (July 20, 2005) .....	272
Response to Chairman and Ranking Member's July 28, 2005, Let- ter (August 9, 2005) .....	274
Appendix F—E-mail Communications and Other FDA Documents .....	277
Press release on approval of VNS Therapy for epilepsy (July 16, 1997) .....	278
E-mail from CDER staff to CDRH staff (October 3, 2003) .....	280
E-mail from CDER psychopharmacology team leader to CDRH re- view team leader and Branch Chief (February 4, 2004) .....	281
E-mails from panel members (June 17, 2004, June 18, 2004 and October 19, 2004) .....	282
E-mail from ODE Deputy Clinical Director to ODE Director (Sep- tember 14, 2004) .....	285
E-mail between ODE Deputy Clinical Director and CDER psychopharmacology team leader (November 24, 2004) .....	286
E-mail between Branch Chief and review team leader (November 24 and 29, 2004) .....	287
E-mail from ODE Deputy Clinical Director to members of review team (December 22, 2004) .....	288
E-mail from review team leader to Branch Chief (December 27, 2004) .....	288
E-mail from Director of the Office of Medical Policy to CDRH Director (December 23, 2004) .....	289
E-mail from CDER medical reviewer to psychopharmacology team leader (January 12, 2005) .....	290
E-mail from ODE Deputy Clinical Director (January 25, 2005) .....	290
Appendix G—Neurological Devices Panel Meeting .....	291
List of Panel Questions .....	292
Appendix H—Minutes .....	293
Phone Call between FDA and Cyberonics (March 1, 2002) .....	294
Phone Call between FDA and Cyberonics (October 11, 2002) .....	297
100-Day PMA-S Meeting (February 4, 2004) .....	298
FDA Review Team Meeting (November 10, 2004) .....	302
Appendix I—FDA Advice/Guidance Documents .....	307
CDRH Medical Device Advice Website Materials:	
Review Process .....	308
Clinical Studies .....	319
PMA Supplements and Amendments .....	326
Final Guidance on Least Burdensome Provisions .....	337
Appendix J—Technology Evaluation Center, Blue Cross and Blue Shield Association .....	363
TEC Report (August 2005) .....	364
Appendix K—CDRH Organizational Chart .....	385



## I. Executive Summary

The United States Senate Committee on Finance (Committee) has exclusive jurisdiction over the Medicare and Medicaid programs. Accordingly, the Committee has a responsibility to the more than 80 million Americans who receive health care coverage under Medicare and Medicaid to oversee the proper administration of these programs, including the payment for medical devices regulated by the Food and Drug Administration (FDA). Given the rising health care costs in this country, and more importantly, in the interest of public health and safety, Medicare and Medicaid dollars should be spent on drugs and devices that have been appropriately deemed safe and effective for use by the FDA, in accordance with all laws and regulations.

In February 2005, Senator Charles Grassley (R-IA) and Senator Max Baucus (D-MT), Chairman and Ranking Member of the Committee, initiated an inquiry into the FDA's handling of Cyberonics, Inc.'s (Cyberonics) pre-market approval application to add a new indication—treatment-resistant depression (TRD)—to Cyberonics's Vagus Nerve Stimulation (VNS) Therapy System, an implanted pulse generator. The Chairman and Ranking Member initiated the inquiry in response to concerns that were raised regarding Cyberonics's VNS Therapy System for TRD. On July 15, 2005, the FDA approved the device for TRD.

The investigative staff of the Committee reviewed documents and information obtained and received from the FDA and Cyberonics and found the following:

- As the federal agency charged by Congress with ensuring that devices are safe and effective, the FDA approved the VNS Therapy System for TRD based upon a senior official overruling the comprehensive scientific evaluation of more than 20 FDA scientists, medical officers, and management staff who reviewed Cyberonics's application over the course of about 15 months. The official approved the device despite the conclusion of the FDA reviewers that the data provided by Cyberonics in support of its application for a new indication did not demonstrate a reasonable assurance of safety and effectiveness sufficient for approval of the device for TRD.
- The FDA's formal conclusions on safety and effectiveness do not disclose to doctors, patients or the general public the scientific dissent within the FDA regarding the effectiveness of the VNS Therapy System for TRD. The FDA has publicized differences of scientific opinion within the agency when it has announced other controversial regulatory decisions. Throughout the review of Cyberonics's application, the team of FDA scientists, medical officers, and management staff involved recommended that the device not be approved for TRD. However, at every stage of the review, the team was instructed by the

FDA official, who ultimately made the decision to approve the device, to proceed with the next stage of pre-market review.

- The FDA has not ensured that the public has all of the accurate, science-based information regarding the VNS Therapy System for TRD it needs. Health care providers relying on the FDA's public information on the safety and effectiveness of this device may not be able to convey complete risk information to their patients, because not all of the relevant findings and conclusions regarding the VNS Therapy System have been made available publicly.

The FDA has an important mission:

The FDA is responsible for protecting the public health by assuring the safety, efficacy, and security of human and veterinary drugs, biological products, medical devices, our nation's food supply, cosmetics, and products that emit radiation. The FDA is also responsible for advancing the public health by helping to speed innovations that make medicines and foods more effective, safer, and more affordable; and helping the public get the accurate, science-based information they need to use medicines and foods to improve their health.<sup>1</sup>

As part of that mission, the FDA weighs the risks and benefits of a product, in this case a medical device, to determine if the product is reasonably safe and effective for use.

The facts and circumstances surrounding the FDA's approval process for the VNS Therapy System for TRD raise legitimate questions about the FDA's decision to approve that device for the treatment of TRD. While all implantable medical devices carry risks, it is questionable whether or not the VNS Therapy System for TRD met the agency's standard for safety and effectiveness. The FDA's approval process requires a comprehensive scientific evaluation of the product's benefits and risks, including scientifically sound data supporting an application for approval. Otherwise health care providers and insurers as well as patients may question the integrity and reliability of the FDA's assessment of the safety and effectiveness of an approved product. In the case of VNS Therapy for TRD, the FDA reviewers concluded that the data limitations in Cyberonics's application could only be addressed by conducting a new study prior to approval. However, in the present case, instead of relying on the comprehensive scientific evaluation of its scientists and medical officers, it appears that the FDA lowered its threshold for evidence of effectiveness. Contrary to the recommendations of the FDA reviewers, the FDA approved the VNS Therapy System for TRD and allowed Cyberonics to test its device post-approval.

In addition, given the significant scientific dissent within the FDA regarding the approval of the VNS Therapy System for TRD, the FDA's lack of transparency with respect to its review of the device is particularly troubling. The FDA has limited the kind and quality of information publicly available to patients and their doctors and deprived them of information that may be relevant to

---

<sup>1</sup><http://www.fda.gov/opacom/morechoices/mission.html>.

their own risk-benefit analysis. Patients and their doctors should have access to all relevant findings and conclusions from the comprehensive scientific evaluation of the safety and effectiveness of the VNS Therapy System for TRD to enable them to make fully informed health care decisions.

## II. Introduction

The United States Senate Committee on Finance (Committee) has exclusive jurisdiction over the Medicare and Medicaid programs. Accordingly, the Committee has a responsibility to the more than 80 million Americans who receive health care coverage under Medicare and Medicaid to oversee the proper administration of these programs. Given the rising health care costs in this country, and more importantly, in the interest of public health and safety, Medicare and Medicaid dollars should be spent on drugs and medical devices that have been appropriately approved by the Food and Drug Administration (FDA), based on a comprehensive scientific evaluation of the product's benefits and risks, in accordance with all laws and regulations.

On July 15, 2005, the FDA approved Cyberonics, Inc.'s (Cyberonics or the sponsor<sup>2</sup>) Vagus Nerve Stimulation Therapy System (VNS Therapy System) for a new indication, the first medical device for treatment-resistant depression (TRD). Medicare and Medicaid currently cover the VNS Therapy System, including programming and implantation of the device, for the treatment of epilepsy, the first indication for which the device was approved. Cyberonics expects that within a year both programs will also cover the device for TRD.<sup>3</sup>

Senator Charles Grassley (R-IA) and Senator Max Baucus (D-MT), Chairman and Ranking Member of the Committee, began an inquiry related to the VNS Therapy System for TRD in February 2005, after allegations of problems with the FDA's review of Cyberonics's device were brought to the attention of the Committee. To review these allegations, the Chairman and Ranking Member initiated an inquiry and sent a letter to the FDA regarding the FDA's review of Cyberonics's pre-market approval application supplement (PMA-S or application) for the use of the VNS Therapy System for TRD (the sponsor's PMA-S) in March 2005.

This Committee Staff Report to the Chairman and Ranking Member (Report) presents the information and findings compiled by the investigative staff of the Committee (Committee Staff) based on interviews and the review of documents and information obtained by and provided to the Committee regarding the VNS Therapy System. Appendices to the Report include: correspondence between the Chairman and Ranking Member and the FDA, documentation of the FDA's internal and external communications regarding the sponsor's PMA-S, and related materials posted on the FDA website. The Table of Contents contains a list of documents

<sup>2</sup>Under 21 C.F.R. § 3.2, the term "sponsor" has the same meaning as "applicant," any person who submits or plans to submit an application to the Food and Drug Administration (FDA) for pre-market review. The sponsor is usually the manufacturer of the product under review, in this case a medical device manufacturer. Under 21 C.F.R. § 812.3, a sponsor is also a person who initiates the clinical studies to determine the safety or effectiveness of a device.

<sup>3</sup>Dow Jones/AP, "FDA approves implant against depression," July 15, 2005, available at <http://www.chron.com/disp/story.mpl/tech/news/3268114.html>, last accessed on January 18, 2006.

in the Appendices. A timeline of major events related to the FDA's review of the sponsor's PMA-S for the VNS Therapy System are also included at the end of this Report.

### III. Scope and Methodology

During the course of its inquiry, the Committee Staff obtained numerous documents related to the FDA's review of Cyberonics's PMA-S for the VNS Therapy System for TRD, including documents that contain clinical data submitted by the sponsor to the FDA as part of its application. The Committee Staff did not independently assess the validity of the data submitted or determine whether or not the sponsor met the FDA's standards for approval of the VNS Therapy System. The purpose of the Chairman and Ranking Member's inquiry was to address the allegations, examine the FDA's review of the sponsor's PMA-S, and consider whether or not Medicare and Medicaid dollars should be spent on a drug or device because it has received FDA approval.

In addition, several individuals who were interviewed by the Committee Staff raised concerns about the FDA's process for pre-market review and post-market surveillance of medical devices generally. A range of allegations regarding the FDA and Cyberonics as well as medical devices in general were brought to the attention of Committee Staff; however, this Report is limited to those allegations most germane to the Committee Staff's initial review of the FDA's approval process for the VNS Therapy System for TRD. Other allegations may be addressed at a later date. This Report focuses solely on matters and events related to the sponsor's PMA-S and how the FDA made the decision to approve the VNS Therapy System for TRD.

By letters dated March 11, April 19, May 17, May 27, July 7, and July 28, 2005, the Chairman and Ranking Member requested from the FDA documents and information related to the FDA's review and approval of the VNS Therapy System for TRD, as well as interviews with FDA staff involved in the review.<sup>4</sup> The Committee Staff review was conducted from February through September 2005.

In conducting the inquiry, the Committee Staff:

- Interviewed eleven FDA employees; six of whom were directly involved in the review of the VNS Therapy System for TRD and internal deliberations regarding the sponsor's PMA-S.
- Reviewed documents provided by the FDA, which were created during the course of the FDA's review of the sponsor's PMA-S.
- Reviewed documents from the sponsor, which were produced voluntarily to the Committee by the sponsor, including filings in support of its PMA-S, e-mail communications, meeting minutes, and other documentation of internal communications, as well as communications between the FDA and the sponsor related to the review of the VNS Therapy System for TRD.

---

<sup>4</sup>Letters from the Chairman and Ranking Member of the Committee to the FDA, see Appendix A.

- Examined FDA regulations regarding medical device review, documentation of contacts with sponsors, and conditional approvals.

## IV. Background

### A. Vagus Nerve Stimulation Therapy System

The VNS Therapy System is an implanted vagus nerve stimulator.<sup>5</sup> The FDA initially approved the VNS Therapy System in July 1997 for epilepsy to help reduce seizures that could not be fully or adequately controlled by drugs or surgery.<sup>6</sup> By letter dated July 15, 2005, the FDA approved the VNS Therapy System “indicated for the adjunctive long-term treatment of chronic or recurrent depression for patients 18 years of age or older who are experiencing a major depressive episode and have not had an adequate response to four or more adequate antidepressant treatments.”<sup>7</sup>

The FDA website ([www.fda.gov](http://www.fda.gov)) provides an overview of the VNS Therapy System, which consists of a pulse generator that is surgically implanted under the skin of the left chest and an electrical lead that is connected from the generator to the left vagus nerve. Electrical signals are sent from the battery-powered generator to the vagus nerve via the lead. To turn the stimulator off, the patient holds a magnet over the pulse generator. The overview provides information regarding usage of the device:

The device is to be used only in patients 18 years of age or over with treatment-resistant depression. These are patients who have been treated with, but failed to respond to, at least 4 adequate medication and/or [electroconvulsive therapy] ECT<sup>8</sup> treatment regimens prescribed by their physician. It is not intended to be used as a first-line treatment, even for patients with severe depression. It should be prescribed and monitored only by physicians who have specific training and expertise in the management of treatment-resistant depression and the use of this device. It should be implanted only by physicians who are trained in surgery of the carotid sheath and have received specific training in the implantation of the device. . . . The device cannot be used in patients who have had their vagus nerve cut or will be exposed to diathermy.<sup>9</sup>

According to the physician and patient labeling for the VNS Therapy System for TRD, commonly reported side effects associated with the use of the device in epilepsy patients and patients with depression include voice alteration, increased cough, dyspnea (shortness of breath), neck pain, and dysphagia (difficulty swal-

<sup>5</sup>FDA’s overview of the VNS Therapy System, see Appendix B; also available at <http://www.fda.gov/cdrh/mda/docs/p970003s050.html>.

<sup>6</sup>FDA’s July 16, 1997, press release on the approval of the VNS Therapy System for the treatment of epilepsy, see Appendix F; also available at <http://www.fda.gov/bbs/topics/NEWS/NEW00576.html>.

<sup>7</sup>Approval letter issued to the sponsor on July 15, 2005, see Appendix B; also available at <http://www.fda.gov/cdrh/PDF/p970003s050a.pdf>.

<sup>8</sup>Electroconvulsive therapy is a type of shock therapy that involves a brief electrical shock that is applied to the head to induce a short seizure. For more information, see <http://www.nlm.nih.gov/medlineplus/ency/article/003324.htm>.

<sup>9</sup>Available at <http://www.fda.gov/cdrh/mda/docs/p970003s050.html>; see also Appendix B.

lowing).<sup>10</sup> Serious adverse events that have been reported include death, cardiac events, vocal cord paralysis, sleep apnea,<sup>11</sup> and worsening depression.

*B. Major Events Related to the Approval of the Vagus Nerve Stimulation Therapy System for Treatment-Resistant Depression*

On October 27, 2003, the sponsor submitted a PMA-S to the FDA to add treatment-resistant depression as a new indication for the VNS Therapy System. Once a device has been cleared through the PMA process, a device manufacturer can file additional information with the FDA as a supplement to the original PMA to demonstrate that an already-approved device is safe and effective for a new indication.<sup>12</sup> In the case of the VNS Therapy System, the original PMA was approved in 1997 for commercial distribution of the device for the treatment of epilepsy.

In 1997, Congress also passed the Food and Drug Administration Modernization Act (FDAMA) to streamline the FDA approval process for medical devices,<sup>13</sup> among other things, to “ensure the timely availability of safe and effective new products that will benefit the public.” According to FDA guidance on the new provisions that were added to the Federal Food, Drug, and Cosmetic Act as a result of FDAMA, “While Congress wanted to reduce unnecessary burdens associated with the premarket clearance and approval processes, Congress did not lower the statutory criteria for demonstrating . . . reasonable assurance of safety and effectiveness.”<sup>14</sup>

The FDA’s standard for approval of an implantable device is “reasonable assurance of safety and effectiveness.”<sup>15</sup> The FDA considers there to be a reasonable assurance of safety when it can be determined that the probable benefits to health that result from the use of the device as directed by the sponsor and accompanied by adequate instructions for use and warnings against unsafe use outweigh any probable risks.<sup>16</sup> The FDA considers there to be a reasonable assurance of effectiveness when, based upon valid scientific evidence, the use of the device in a significant portion of the target population according to the sponsor’s instructions will produce clinically significant results.<sup>17</sup>

Once the FDA receives a PMA-S, a team of FDA scientists and medical officers is assigned to review the application. The review team assigned to Cyberonics’s PMA-S consisted of more than a dozen FDA scientists and medical officers from the Center for De-

<sup>10</sup>The Physician and Patient Labelings for the VNS Therapy System for TRD are available at <http://www.fda.gov/cdrh/PDF/P970003S050.html>; see also Appendix B.

<sup>11</sup>According to the National Institutes of Health’s National Institute of Neurological Disorders and Stroke, sleep apnea is a common sleep disorder characterized by brief interruptions of breathing during sleep. For more information, see [http://www.ninds.nih.gov/disorders/sleep\\_apnea/sleep\\_apnea.htm](http://www.ninds.nih.gov/disorders/sleep_apnea/sleep_apnea.htm).

<sup>12</sup>21 C.F.R. § 814.39(a)(1), see Appendix C; see also Congressional Research Service, *The U.S. Approval Process for Medical Devices: Legislative Issues and Concerns with the Drug Model*, RL32826 (March 23, 2005), available at <http://www.congress.gov/erp/rl/pdf/RL32826.pdf>.

<sup>13</sup>Pub. L. No. 105–115, 111 Stat. 2296, 2336–2338.

<sup>14</sup>Food and Drug Administration, “The Least Burdensome Provisions of the FDA Modernization Act of 1997: Concept and Principles; Final Guidance for FDA and Industry,” October 4, 2002, see Appendix I; also available at <http://www.fda.gov/cdrh/ode/guidance/1332.pdf>.

<sup>15</sup>21 C.F.R. § 860.7, see Appendix C.

<sup>16</sup>21 C.F.R. § 860.7(d)(1), see Appendix C.

<sup>17</sup>21 C.F.R. § 860.7(e)(1), see Appendix C.

vices and Radiological Health (CDRH)<sup>18</sup> and the Center for Drug Evaluation and Research (CDER).<sup>19</sup> This team included neurosurgeons, neurologists, psychiatrists, statisticians, epidemiologists, and adverse events analysts. Management staff of the Restorative Devices Branch, the Division of General, Restorative and Neurological Devices (DGRND), and the Office of Device Evaluation (ODE) in CDRH and the Division of Neuropharmacological Drug Products<sup>20</sup> and the Office of Drug Evaluation I in CDER were also involved in the review of the sponsor's PMA-S.

After a sponsor submits its PMA-S, the review team determines whether or not that sponsor provided the required administrative components of the PMA-S. The FDA has 45 days to make sure an application is administratively complete.<sup>21</sup> If an application is complete, the FDA formally files it and begins its substantive review. By letter dated December 15, 2003, the FDA informed Cyberonics that its PMA-S was suitable for filing<sup>22</sup> and granted expedited review because "the VNS Therapy System has the potential of providing therapeutic benefits . . . in the treatment of patients who are intolerant or resistant to other legally marketed therapies."<sup>23</sup> FDA guidance states that a device is appropriate for expedited review if the device is (1) intended to treat or diagnose a life-threatening or irreversibly debilitating disease or condition, and (2) addresses an unmet medical need.<sup>24</sup>

The CDRH website states that during the PMA review process, the FDA notifies a sponsor by major/minor deficiency letters of any information needed by the FDA to complete its review. In addition, a sponsor can request a meeting with the FDA within 100 days of the filing of its application to discuss the status of the FDA's review.<sup>25</sup> According to the FDA review team leader for Cyberonics's PMA-S, on February 4, 2004, 100 days after the sponsor filed its application, the FDA held a meeting with the sponsor to discuss concerns or questions related to the sponsor's PMA-S. The team leader stated that the sponsor did not address all the concerns discussed during the 100-day meeting; and that the 23 concerns not addressed were identified in a major deficiency letter that the FDA sent to the sponsor on March 1, 2004. In that letter, the FDA stat-

<sup>18</sup>Members of the review team include staff from the Division of General, Restorative and Neurological Devices in the Office of Device Evaluation, the Division of Bioresearch Monitoring in the Office of Compliance, and the Division of Biostatistics and Surveillance and the Division of Postmarket Surveillance in the Office of Surveillance and Biometrics. See CDRH organizational chart, Appendix K.

<sup>19</sup>Members of the review team include staff from the Division of Neuropharmacological Drug Products in the Office of Drug Evaluation I.

<sup>20</sup>In the summer of 2005, the Division of Neuropharmacological Drug Products was split into two divisions within the Office of Drug Evaluation I, the Division of Neurology Products and the Division of Psychiatry Products.

<sup>21</sup>21 C.F.R. §814.42(a), see Appendix C.

<sup>22</sup>The filing date is the date on which the FDA received the sponsor's PMA-S, October 27, 2003.

<sup>23</sup>Letter to the Director and Senior Counsel, Regulatory Affairs, Cyberonics, Inc. signed by the Director of the Division of General, Restorative and Neurological Devices, Office of Device Evaluation, CDRH, December 15, 2003, see Appendix E.

<sup>24</sup>Food and Drug Administration, U.S. Department of Health and Human Services, "Guidance for Industry and FDA Staff: Expedited Review of Premarket Submissions for Devices," November 26, 2003, available at <http://www.fda.gov/cdrh/mdufma/guidance/108.html>.

<sup>25</sup>CDRH Device Advice website, [http://www.fda.gov/cdrh/devadvice/pma/review\\_process.html](http://www.fda.gov/cdrh/devadvice/pma/review_process.html); see also Appendix I.

ed that its review of the PMA-S could not continue until the sponsor addressed the 23 deficiencies described therein.<sup>26</sup>

Once a sponsor addresses the concerns and questions identified in a major deficiency letter, the review team can complete its initial review of the PMA-S and determine whether or not to proceed with an advisory panel to obtain input and recommendations from outside experts on the approvability of the device.<sup>27</sup> In the case of VNS Therapy, the Committee Staff were told that the review team did not believe that the sponsor had satisfactorily addressed all of the deficiencies. However, the Director of ODE, who became the Acting Director of CDRH in May 2004 and the Director in August 2004, instructed the review team to proceed with an advisory panel meeting. On June 15, 2004, the FDA Neurological Devices Panel was held to address several questions from the FDA regarding the sponsor's PMA-S, including whether or not the clinical data in the PMA-S provided a reasonable assurance of safety and effectiveness.<sup>28</sup> The panel recommended, by a vote of five to two, that the device be approved with the following conditions:

- (1) Patients should fail four or more traditional treatment modalities for TRD (*i.e.*, antidepressant medications or electroconvulsive therapy (ECT)) before using the VNS Therapy System for TRD.
- (2) The device should be implanted by surgeons with appropriate training.
- (3) Training regarding the programming of the device should be provided to primary care providers.
- (4) The product should have additional patient labeling to inform patients completely of the risks and benefits involved in having the device implanted and an identification card should be provided to patients that indicate they have the device implanted.

<sup>26</sup>For example, the FDA stated that according to the National Depressive and Manic Depressive Association Consensus panel, "patients with mood disorders have inherently high placebo response rates, and without a placebo (control) or valid alternative method, . . . most findings are difficult to interpret." Because the sponsor's only placebo-controlled study failed, the FDA asked the sponsor to provide any additional information that would address the potential bias that may occur from a placebo effect. See Appendix E for the text of the major deficiency letter. A "placebo" is an inactive substance or treatment against which investigational treatments are compared for efficacy and safety. A "placebo-controlled study" is a study in which an inactive substance or treatment (placebo) is given to one group of patients, while the treatment being tested is given to another group. High placebo response rate, or "placebo effect" is a physical or emotional change, such as an improvement in health or alleviation of symptoms, that is not the result of any special property of the treatment received but may occur because individuals expect or believe that the treatment will work.

<sup>27</sup>See Congressional Research Service, *The U.S. Approval Process for Medical Devices: Legislative Issues and Concerns with the Drug Model*, RL32826 (March 23, 2005), available at <http://www.congress.gov/erp/rl/pdf/RL32826.pdf>. According to the CDRH Device Advice website on the PMA review process, all PMAs for a first-of-a-kind device are generally referred to an advisory panel for review and recommendation. Once the FDA believes that "(1) the pertinent issues in determining the safety and effectiveness for the type of medical device are understood and (2) FDA has developed the ability to address those issues," future PMAs for that type of device are not taken before a panel unless there is an issue that can be best addressed through panel review. See [http://www.fda.gov/cdrh/devadvice/pma/review\\_process.html](http://www.fda.gov/cdrh/devadvice/pma/review_process.html). A copy of the review process overview is included in Appendix I.

<sup>28</sup>The other questions were: (1) whether or not data that are not derived from a randomized study affect the evaluation of the effectiveness of the VNS Therapy System for TRD, *i.e.*, a study where the subjects are randomly assigned to VNS Therapy and no VNS Therapy; (2) whether or not the clinical outcomes of one of the sponsor's major studies were the result of a "placebo effect"; and (3) whether or not the use of antidepressant medications and electroconvulsive therapy in conjunction with VNS Therapy impact the interpretation of the study results on the effectiveness of the VNS Therapy System for treatment-resistant depression. See Appendix G for the list of panel questions.



(5) A patient registry to collect clinical data should be established.

(6) The patient labeling should be revised regarding, among other things, the description of the 12 month open label follow-up study and the variable effect of treatment.<sup>29</sup>

The FDA considers an advisory panel's recommendations in deciding whether or not to approve a device; however, panel recommendations are not binding. In this case, although the advisory panel recommended conditional approval, the FDA issued a not approvable letter to the sponsor on August 11, 2004.<sup>30</sup> According to the FDA, a not approvable letter means that the FDA found the data provided by the sponsor insufficient to establish that there is a reasonable assurance that the device is safe and/or effective for the use(s) specified in the sponsor's application.

FDA regulations state that, after a sponsor receives a not approvable letter, the sponsor may amend its PMA as outlined in the not approvable letter, request an administrative review by filing a petition for reconsideration under 21 C.F.R. §10.33, or withdraw its application.<sup>31</sup> The FDA Ombudsman for CDRH informed the Committee Staff that, in practice, the sponsor has several options if it wants to continue to seek approval for its product. The sponsor can submit an amendment to the PMA-S to address the problems identified in the not approvable letter; the sponsor can petition the FDA to reconsider its decision; the sponsor can appeal up the supervisory chain; or the sponsor can file a formal appeal of the decision to the dispute resolution panel.<sup>32</sup>

In this case, Cyberonics requested that the FDA reconsider the not approvable decision, but after examining additional data provided by the sponsor, the ODE Director concluded that there was no basis for reconsideration. Consequently, on September 23, 2004, the sponsor submitted an amendment to its PMA-S (Amendment) to address the deficiencies identified in the August 11, 2004 not approvable letter. The Amendment included analyses of additional data from studies conducted by the sponsor to examine the responses of TRD patients to VNS Therapy.

In addition to its Amendment, on September 10, 2004, the sponsor submitted a request for a Treatment Investigational Device Exemption (Treatment IDE) to the FDA. A Treatment IDE allows a device that is not yet approved for marketing to be used to treat patients with a serious or immediately life-threatening disease or condition when no comparable or satisfactory alternative device or treatment is available. "The purpose is to facilitate the availability of promising new devices to desperately ill patients as early in the device development process as possible, . . . and to obtain additional data on the device's safety and effectiveness."<sup>33</sup> The device must be under investigation in a clinical trial for the same use, or the clinical trials are completed but the sponsor is pursuing marketing approval of the device. The FDA conditionally approved the

<sup>29</sup>The transcript of the June 15, 2004, Neurological Devices Panel meeting is available at <http://www.fda.gov/ohrms/dockets/ac/04/transcripts/2004-4047t1.htm>.

<sup>30</sup>Not Approvable Letter, *see* Appendix E.

<sup>31</sup>21 C.F.R. §814.44(f), *see* Appendix C.

<sup>32</sup>21 C.F.R. §10.75, *see* Appendix C; the Ombudsman and several other FDA staff informed the Committee Staff that the last option is rarely used.

<sup>33</sup>21 C.F.R. §812.36, *see* Appendix C.

sponsor's Treatment IDE on September 22, 2004. On October 1, 2004, the sponsor submitted an IDE Supplement to address deficiencies identified in FDA's conditional approval, and the FDA approved the IDE Supplement on October 15, 2004.

Over the next few months, the sponsor continued to meet and communicate with FDA officials regarding the Amendment. On December 1, 2004, the CDRH Director convened a meeting between members of the FDA review team and the sponsor's clinical, statistical, legal, and management staff. According to the team leader and DGRND Director, only four members of the review team were invited to the meeting; the management staff at the branch and division levels who were involved in the review of the sponsor's PMA-S were not invited to attend. The purpose of the meeting was to further discuss the deficiencies listed in the August 11, 2004, not approvable letter and consider options to obtain FDA approval, including options for another pre-market study or a commitment from the sponsor to conduct additional studies once the device was approved. After the meeting, the sponsor submitted proposals for a randomized, double-blind<sup>34</sup> comparison study to be conducted post-approval. Based on a review of communications and documents provided to and obtained by the Committee Staff, there were no pre-approval studies proposed or discussed with the sponsor after December.

In addition to the review of a sponsor's PMA, the FDA inspects the sponsor's operations and records to ensure that medical devices are designed, manufactured and distributed in compliance with the Current Good Manufacturing Practices (CGMP) requirements of the Quality System Regulation<sup>35</sup> and other standards. During an interview with Committee Staff, the ODE Director stated that it was not unusual for the FDA to clear a PMA but not approve the device because the sponsor fails an inspection. On December 22, 2004, the FDA issued a warning letter to the sponsor identifying a number of significant violations of the Quality System Regulation, including a failure to establish and maintain adequate procedures for validating device design, failure to completely investigate and evaluate the case of each adverse event, and failure to establish and maintain procedures for implementing corrective and preventive actions.<sup>36</sup> On January 21, 2005, the sponsor submitted its response to the warning letter, and on April 6, 2005, the sponsor was notified that its response was complete.

On February 2, 2005, the FDA issued an approvable letter to the sponsor, which superceded the not approvable letter issued on August 11, 2004.<sup>37</sup> An approvable letter is not a final approval. However, if the FDA determines that the sponsor has met the conditions outlined in the approvable letter, the device can be approved for the specified use. The conditions outlined in Cyberonic's approvable letter included conducting two post-approval studies: (1) estab-

---

<sup>34</sup> Patients are randomly assigned to different treatment groups, and neither the study investigator nor the patient knows to which treatment group the patient has been assigned.

<sup>35</sup> 21 C.F.R. Part 820.

<sup>36</sup> See Appendix E for the full text of the warning letter.

<sup>37</sup> According to FDA regulations, the FDA sends a manufacturer an approvable letter if the manufacturer's application substantially meets the requirements of FDA regulations, and the FDA believes it can approve the application if the manufacturer provides additional information or agrees to certain conditions specified by the FDA, such as product labeling and post-approval requirements, 21 C.F.R. § 814.44, see Appendix C.

lishing a registry of 1,000 TRD patients implanted with the vagus nerve stimulator and evaluating their response to the therapy for five years after implantation; and (2) conducting a randomized, double-blind comparison of different output of currents from the device in 450 TRD patients with follow-up for at least one year after implantation to determine the optimal dosage of stimulation in patients with TRD. The FDA also required the sponsor to submit revised physician and patient labelings for the VNS Therapy System for TRD and to address any deficiencies identified during FDA inspections of the sponsor's clinical study sites. In addition, the sponsor was informed that the PMA-S could not be approved until the FDA determined that the manufacturing facilities, methods, and controls complied with the conditions set forth in the sponsor's application and the applicable requirements of the Quality System Regulation.<sup>38</sup>

On July 15, 2005, the CDRH Director signed the approval letter for the VNS Therapy System for TRD. The approval letter allows the sponsor to begin commercial distribution of the VNS Therapy System for TRD; however, as specified in the February 2, 2005 approvable letter, the sponsor must meet certain conditions, including two post-approval studies.<sup>39</sup>

### *C. Post-Approval Events*

Since the approval of the VNS Therapy System for TRD in July 2005, the sponsor has initiated efforts to secure reimbursement for the use of its device to treat TRD. In September 2005, the American Medical Association's Current Procedural Terminology<sup>40</sup> (CPT) Editorial Board approved the use of the same neurostimulator programming codes that are currently being used for VNS Therapy programming services for patients with epilepsy for the treatment of patients with TRD.

In addition, the BlueCross BlueShield Technology Evaluation Center (TEC), which provides scientific opinions regarding the clinical effectiveness and appropriateness of specific medical procedures, devices, and drugs, published its assessment of the VNS Therapy System for TRD in August 2005.<sup>41</sup> The TEC examined the available evidence on the effectiveness of the VNS Therapy System for TRD, including findings from three of the sponsor's clinical studies, and concluded that "Overall, the evidence supporting efficacy of VNS is not strong."<sup>42</sup> Based on the evidence it reviewed, the TEC determined that the VNS Therapy System did not meet

<sup>38</sup> See Appendix E for the full text of the approvable letter.

<sup>39</sup> See 21 C.F.R. § 814.82, Appendix C.

<sup>40</sup> CPT Codes describe the medical or psychiatric procedures performed by health care providers.

<sup>41</sup> D. Mark, "Vagus Nerve Stimulation for Treatment-Resistant Depression," August 2005, see Appendix J; also available at [http://www.bcbs.com/tec/vol20/20\\_08.html](http://www.bcbs.com/tec/vol20/20_08.html).

<sup>42</sup> According to the TEC website (<http://www.bcbs.com/tec/>), the TEC uses five criteria to assess whether a technology improves health outcomes: (1) The technology must have final approval from the appropriate governmental regulatory bodies; (2) the scientific evidence must permit conclusions concerning the effect of the technology on health outcomes; (3) the technology must improve the net health outcome; (4) the technology must be as beneficial as any established alternatives; and (5) the improvement must be attainable outside the investigative settings.

all of its criteria for demonstrating that the device improves health outcomes, such as length of life and quality of life.<sup>43</sup>

#### *D. Summary of Cyberonics's Clinical Studies*

After a device is approved for marketing by the FDA, a potential new use for the device may be discovered through observations from additional clinical trials or by health care providers in the course of using the device as approved by the FDA or off-label to treat their patients.<sup>44</sup> According to the FDA review team leader on the sponsor's PMA-S, after the VNS Therapy System was approved for epilepsy in 1997, anecdotal reports of mood alteration were noted in some of the epilepsy patients implanted with the vagus nerve stimulator.

To investigate these reports, the sponsor conducted a pilot study (D-01) of 60 patients with treatment-resistant depression to examine their response rates to the device. D-01 was an open-label, non-randomized, single-treatment arm study—all 60 patients were implanted with the device and were aware that they were receiving VNS Therapy. The study had no control groups, *i.e.*, patients without the device implanted or patients with an inactive device, so patient response rates could not be compared. VNS Therapy was used as an adjunctive treatment, so patients continued their antidepressant medication regimen during the study. The study consisted of a 12-week (after implantation) acute phase and a long-term follow-up. A health care provider-administered screening tool known as the Hamilton Rating Scale for Depression (HRSD) was used to rate the severity of depression; the higher the score, the more severe the depression. The sponsor defined a response to the VNS Therapy System as a 50 percent or greater reduction in the HRSD score. Based on this definition, at the end of 12 weeks, 18 of 59 patients (31 percent) responded to the device. After one and two years of VNS Therapy in conjunction with antidepressant medication and/or ECT treatment regimens, 25 of 55 (45 percent) and 18 of 42 (43 percent) patients, respectively, exhibited a response.<sup>45</sup>

As mentioned previously, a sponsor can file a supplement to an original PMA to obtain approval for a new indication for a device. To obtain FDA approval for the new indication, the sponsor must demonstrate a reasonable assurance that the device is safe and effective for the new indication. According to FDA regulations, reasonable assurance of effectiveness must be based on "valid scientific evidence."<sup>46</sup> Valid scientific evidence consists principally of well-controlled clinical investigations, which include assigning study subjects to tests groups that can be compared. The regulations specify four types of controls to which subjects receiving the treatment under investigation can be compared: (1) no treatment; (2) placebo control, *e.g.*, an implanted device that has not been acti-

<sup>43</sup>The TEC reviewed published and unpublished data related to the clinical outcomes of the VNS Therapy System for TRD. The sponsor's response to the TEC assessment is available on its VNS Therapy for TRD website at <http://www.vnstherapy.com/depression/hcp/ReimbursementIns/data.aspx>.

<sup>44</sup>Physicians use a device "off-label" when they prescribe an FDA-approved product for treatments other than those specified on the product labeling.

<sup>45</sup>See Appendix B, Summary of Safety and Effectiveness, p. 68, and Physician Labeling, p. 110.

<sup>46</sup>21 C.F.R. § 860.7(e), *see* Appendix C.

vated used under conditions that resemble the conditions of use under investigation; (3) active treatment control, *i.e.*, comparison to an effective treatment; and (4) historical control, *i.e.*, comparison to a group of patients receiving no treatment or an established effective regimen who were observed at a previous time.<sup>47</sup>

To address the requirement of “valid scientific evidence,” the sponsor conducted a second study, a randomized, placebo-controlled study (D-02), to examine the difference in responses to VNS Therapy over a 12-week period between patients with TRD whose devices were activated compared to those whose devices were not activated. In this first phase of D-02, also known as the acute phase, all study participants were implanted with the device, but 119 patients had the device activated (the treatment group) and 116 patients did not (the placebo control group). The patients were randomly assigned to the treatment group or the control group. Patients were allowed to continue the antidepressant treatments that they were already receiving, but changes to those treatment regimens were not allowed during the course of the study. After 12 weeks, based on the HSRD scores, about 15 percent of the treatment group responded compared to 10 percent of the control group; however, because the difference observed was not “statistically significant,” any differences observed between the two groups of patients could have been due to chance rather than a response to the device.

The second phase of D-02 was a long-term follow-up. In this phase, all of the inactive devices that were implanted in the patients during the acute phase of D-02 were turned on, so the study lost its placebo control group. The sponsor used a population of 124 patients from a different study (D-04) to act as a comparison group. D-04 was a long-term, observational study, in which patient responses to the usual standard of care for people with a major depressive episode—antidepressant medications and/or ECT—were observed and noted by the study investigators.

In the long-term phase of D-02, there were no restrictions on changing patients’ antidepressant treatment regimens during the course of the study, which were taken in conjunction with VNS Therapy. After 12 months, about 30 percent of the D-02 patients had a 50 percent or greater reduction in their HSRD scores. About 22 percent responded based on a different screening tool used by the sponsor to assess patient response rates, the Inventory of Depressive Symptomatology-Self-Report (IDS-SR). Unlike the HSRD, the IDS-SR is not administered by a health care provider. The response rates for the D-04 patients at 12 months were 12 percent (IDS-SR) and 13 percent (HSRD). In addition, the sponsor examined the level of sustained response in D-02 compared to D-04 patients and found a statistically significant difference between the two groups—13 percent of the D-02 patients evaluated had a sustained response compared to 4 percent in the D-04 group. Sustained response was defined as a 50 percent improvement or better in the IDS-SR scores at 9 months and 12 months.

---

<sup>47</sup> 21 C.F.R. § 860.7(f), *see* Appendix C.

In addition to the D-02/D-04 comparative study, the sponsor submitted data from three other studies to support its application for FDA approval to market the VNS Therapy System for TRD. D-03 was a Phase IV European post-market study in 47 patients with chronic or recurrent depression.<sup>48</sup> D-05 was not a clinical study but a videotape assessment of D-02 patients, and D-06 was a clinical study examining VNS Therapy in seven patients with bipolar disorder.

The FDA's not approvable and approval decisions regarding the safety and effectiveness of the VNS Therapy System for TRD were based primarily on the FDA's evaluation of data collected from the D-01, D-02 and D-04 studies.<sup>49</sup>

## V. Discussion

### A. FDA Official Overruled Review Team: Device Approved Despite Team's Objections

In February 2005, after the FDA issued an approvable letter to the sponsor, concerns were raised regarding FDA's review of the sponsor's PMA-S for the VNS Therapy System for TRD. Specifically, it was alleged that the CDRH Director signed an approvable letter despite strong objections from the FDA review team for the sponsor's PMA-S and the DGRND and ODE management staff involved in the review. The FDA reviewers concluded that based on the data provided to the FDA in the PMA-S, the sponsor did not demonstrate a reasonable assurance of safety and effectiveness for approval of the device for TRD. Nevertheless, the CDRH Director decided that the VNS Therapy System should be approved for TRD and the FDA issued an approval letter to the sponsor on July 15, 2005.<sup>50</sup>

In interviews with Committee Staff, the review team leader, the DGRND Director, the ODE Deputy Clinical Director, and the ODE Director all expressed concerns regarding the CDRH Director's decision to conditionally approve the VNS Therapy System for TRD. The review team recommended that the device not be approved for TRD because the team determined, over the course of about 15 months, the sponsor did not provide "a reasonable assurance that the probable benefits to health from use of the device for its intended uses and conditions outweigh the risks associated with its use."<sup>51</sup> According to an FDA medical officer who was involved in the review of the sponsor's PMA-S, "surgically implanted devices

<sup>48</sup>The VNS Therapy System is approved in the European Union and Canada for use in the treatment of TRD.

<sup>49</sup>See Appendix B for the FDA's Summary of Safety and Effectiveness, which provides, among other things, additional results and details from these studies, pp. 68, 71-82.

<sup>50</sup>In the Preamble to a final rule amending the FDA's regulations governing the content and format of labeling for human prescription drug and biological products, the FDA recently asserted the following:

Under the act and FDA regulations, the agency determines that a drug is approvable based not on an abstract estimation of its safety and effectiveness, but rather on a comprehensive scientific evaluation of the product's benefits and risks under the conditions of use prescribed, recommended, or suggested in the labeling.

Although the final rule relates to drug and biological products, the import of the policy statement articulated by the FDA bears directly on the facts, circumstances, and findings of this Report. See "Requirements on Content and Format of Labeling for Human Prescription Drug and Biological Products," 71 Fed. Reg. 3922, 3934 (January 24, 2006) (to be codified at 21 C.F.R. pts. 201, 314, and 601).

<sup>51</sup>Final review team memorandum, see Appendix D, p. 205.

carry known risks including infection, need for future removal of the device, and injury to structures in and around the operative site (specifically vagal and recurrent laryngeal nerve injury) as well as the risk of anesthesia, which is also significant. In order to outweigh these risks, a device must demonstrate efficacy.”<sup>52</sup>

During interviews with Committee Staff, the FDA staff stated that decisions regarding the approval or non-approval of medical devices are typically made at the division level of CDRH, unless the device is the first of its kind or the device is being reviewed for a new indication. Under those circumstances, the ODE Director signs the letter of approval or non-approval, although the ODE Director informed Committee Staff that she typically reads only the review team’s internal review memorandum before she makes a decision. The review memorandum documents a team’s rationale for recommending approval or non-approval of a device. In the case of VNS Therapy for TRD, the review of the application was elevated from the division level (DGRND), to the office level (ODE), and finally to the center level (CDRH).

The review team’s final review memorandum, dated January 6, 2005, recommended that the VNS Therapy System not be approved for TRD.<sup>53</sup> This memorandum was approved and signed by the team leader, the Restorative Devices Branch Chief, the DGRND Deputy Director and Director, and, atypically, included the signature of the ODE Director. The ODE Director informed Committee Staff that the internal review memorandum only provides signature lines for the team leader, branch chief, deputy division director and division director.<sup>54</sup>

Because the review of the sponsor’s PMA-S had been elevated to the ODE level, the August 11, 2004, not approvable letter was signed by the ODE Director. During an interview, the ODE Director informed Committee Staff that she added her signature to the review team’s January 2005 memorandum when she realized that the Center Director would likely be overriding the not approvable decision.<sup>55</sup> She explained that she wanted to make clear her concurrence with the rest of the review team that the VNS Therapy System for TRD should not be approved because the data provided by the sponsor were insufficient to meet the standard of reasonable assurance of safety and effectiveness.

The review team was not convinced that the additional data provided by the sponsor as part of its Amendment submission were sufficient for approval. After reviewing the data, the review team met on November 10, 2004, to discuss the submission and vote on whether the sponsor’s application should be approved, conditionally approved, or considered not approvable. Aside from one abstention, the members of the review team who were present at the meeting unanimously recommended that the device not be approved.<sup>56</sup>

<sup>52</sup> Post-panel meeting memorandum from a medical officer on the review team to the team leader for the Administrative File of the sponsor’s PMA-S, June 22, 2004, *see* Appendix D, p. 202.

<sup>53</sup> Final review team memorandum, *see* Appendix D, pp. 215–216.

<sup>54</sup> Final review team memorandum, *see* Appendix D, p. 216.

<sup>55</sup> Final review team memorandum, *see* Appendix D, p. 216.

<sup>56</sup> *See* Appendix I for minutes from the November 10 meeting, which include summaries of the concerns and issues raised by team members representing other divisions and offices within CDRH as well as concerns raised by the Division of Neuropharmacological Drug Products within

In addition to the internal review memorandum and meeting minutes, the team leader and the ODE Deputy Clinical Director expressed concerns regarding approval of VNS Therapy for TRD in e-mail communications to other members of the team. After informing the team leader and several other members of the review team that the CDRH Director would be making the decision regarding approval, the ODE Deputy Clinical Director wrote in an e-mail dated December 22, 2004:

It will be tough for most if not all of us to look at a post-approval study . . . since we don't agree with the approval decision.<sup>57</sup>

When the review team leader became aware that the CDRH Director was "leaning towards approval," he requested that the review of submissions related to VNS Therapy for TRD be reassigned to another FDA reviewer. In an e-mail dated December 27, 2004, he wrote:

Considering my scientific recommendation of not approvable based on the lack of clinical data supporting a reasonable assurance of safety or effectiveness and my knowledge of the ethical uncertainty in how they may have collected data in their epilepsy registry, I believe I have little to contribute in either the proposed dosage study or the post-market registry.<sup>58</sup>

In another message from the ODE Deputy Clinical Director to the team leader and several other members of the review team dated January 25, 2005, he wrote:

I think it is clear down here that [the CDRH Director] is going to approve VNS for Depression. . . . I know that both of you believe this product should not be approved (as do I) but [the CDRH Director] is asking us to at least make sure there is truth in the labeling and I think that can be done regardless of our individual takes on the approvable/not approvable decision.<sup>59</sup>

CDER staff involved in the PMA-S review were also concerned about the VNS Therapy System being approved by CDRH for TRD. In an e-mail dated January 12, 2005, a CDER medical reviewer stated:

I am disturbed that VNS might actually get an approval for "TRD". In my opinion, they do not have adequate data and I don't understand how this can move forward. I think you feel much the same but what will happen if the post-approval study is negative? Will the device be withdrawn? And, more importantly, it seems this type of data should come before approval.

---

CDER. *See also* memoranda included in Appendix D for more detailed discussions of the concerns and issues raised by the review team members related to the sponsor's response to the August 11, 2004 not approvable letter.

<sup>57</sup> See Appendix F.

<sup>58</sup> *Ibid.*

<sup>59</sup> *Ibid.*



I feel like I can't just sit back and watch this happen without asking if there is anything more we can do. . . . As an M.D. with an interest in science, it seems to me that such an approval would be akin to approving an experimental product and is this what the FDA does?<sup>60</sup>

Committee Staff interviewed the CDRH Director in April 2005 and asked questions relating to his decision to issue an approvable letter to the sponsor in February 2005 despite the recommendations of the review team and the management staff at the branch, division, and office levels of CDRH. According to FDA regulations, as explained to Committee Staff by members of the review team, an approval letter signed by the CDRH Director would reverse the ODE's August 11, 2004, not approvable decision. Therefore, if the CDRH Director approved the device for TRD, he would be required to document his rationale for approving the device in an internal override memorandum.<sup>61</sup> At the time of the interview, the CDRH Director informed Committee Staff that he had not made his decision regarding approval of the device, and therefore, had not yet drafted the override memorandum.

On July 15, 2005, the FDA approved the VNS Therapy System for use in TRD patients. By signing the approval letter, the CDRH Director overruled the comprehensive scientific evaluation of FDA review team for the sponsor's PMA-S, including more than 20 FDA scientists, medical officers and management staff. According to the CDRH Director's override memorandum dated June 12, 2005, he found the additional long-term data from the D-01 and D-02 studies that the sponsor submitted as an amendment to its PMA-S (Amendment) to be compelling support for approval of the device, contrary to the review team's conclusions regarding that data.

*B. FDA's Public Materials Do Not Reveal the Extent of Scientific Dissent Regarding Effectiveness of the Device*

The Summary of Safety and Effectiveness (Summary), which is posted on the FDA's website, is silent with respect to the level of scientific dissent within CDRH regarding the safety and effectiveness of the VNS Therapy System for TRD. It simply states that CDRH believes that the sponsor "has provided reasonable assurance of safety and effectiveness based on valid scientific evidence as required by statute and regulation for the approval of a Class III medical device."<sup>62</sup> However, throughout the review of the sponsor's PMA-S, the review team recommended to the CDRH Director that the device not be approved for TRD. Yet, at every stage of the review, the team was instructed by the CDRH Director to proceed with the next stage of pre-market review.

<sup>60</sup>See Appendix F.

<sup>61</sup>21 C.F.R. § 10.70 requires documentation of significant agency decisions in an administrative file. The administrative file must contain, among other things, "the recommendations and decisions of individual employees, including supervisory personnel, responsible for handling the matter," see Appendix C.

<sup>62</sup>Medical devices are classified based on the risk they pose when patients use or misuse them. There are three classes of devices, Class I, II, and III. Class III devices include devices that are life-supporting or life-sustaining, and devices that present a high or potentially unreasonable risk of illness or injury to the patient.

The Summary also presents a single conclusion from CDRH regarding the June 15, 2004, advisory panel's recommendation. It states that CDRH "concurred with the Panel's recommendation of June 15, 2004, and issued a letter to the sponsor on February 2, 2005, advising that its PMA was approvable subject to" specified conditions. However, CDRH did not initially concur with the Panel's recommendation of an approvable decision. A not approvable letter was issued by the FDA on August 11, 2004. FDA staff who were interviewed by Committee Staff explained that although the panel recommended approval with conditions, the review team considered the panel's discussion and deliberations as well as its recommendations in deciding whether or not the VNS Therapy System should be approved for use in TRD patients.<sup>63</sup> Based on the comments of the panel members<sup>64</sup> and the review team's evaluation of the PMA-S, the review team concluded that the data submitted by the sponsor with its PMA-S did not meet the standard of reasonable assurance of safety and effectiveness.

Several FDA management staff, including the CDRH Director, stated in interviews with Committee Staff that the CDRH Director is very rarely directly involved in the approval or non-approval of medical devices. They could recall only one other instance where the Center Director made the final decision regarding a device's approvability in the past decade. In that instance, the Center Director decided not to reverse the Office Director's decision. In the case of the VNS Therapy System, the FDA review team that evaluated the VNS Therapy System for TRD strongly disagreed with the CDRH Director's decision to approve that device, but despite the team's conclusions about the device, the CDRH Director decided independently to approve the VNS Therapy System for TRD.

Prior to Cyberonics's PMA-S submission on October 27, 2003, CDRH had expressed concerns about Cyberonics's acute D-02 data; however, the Center accepted the sponsor's application for review. According to an e-mail communication from CDER staff to CDRH staff, dated October 3, 2003, if a sponsor had submitted to CDER

<sup>63</sup>Although the panel recommended approval with conditions, one panel member stated in an e-mail to the Executive Secretary of the Neurological Devices Panel dated June 18, 2004, "If I were to have voted up front, I would have not approved the device." Another panel member said in an e-mail dated October 19, 2004, that she was not surprised that the FDA issued a not approvable letter despite the panel's recommendation. She stated, "This was not surprising in and of itself, given the less than impressive nature of the data as well as the extreme ambivalence about the approval as reflected in the deliberations of the panel. I certainly was very ambivalent myself." One of the two members who did not believe VNS Therapy should be approved stated in an e-mail to a supervisory medical officer in CDER dated June 17, 2004, that "The sponsor did not present convincing data that the treatment was effective, nor in my mind, that it was safe." See Appendix F.

<sup>64</sup>According to several members of the review team, the panel's recommendation was inconsistent with its discussion of the data on the risks and benefits of VNS Therapy. In particular, even though the panel members found that without a randomized, controlled study they could not determine how much of the response to VNS stimulation was due to a placebo effect or what impact concomitant medications and ECT had on interpreting the efficacy of the VNS Therapy System for TRD patients—two of the concerns that led the review team to recommend non-approval of the device—the majority of the panel members still concluded that the data provided a reasonable assurance of effectiveness. See Neurological Devices Panel Meeting Transcript, p. 343-357, 363-368, <http://www.fda.gov/ohrms/dockets/ac/04/transcripts/2004-404711.DOC>. The BlueCross BlueShield Technology Evaluation Center's evaluation of the evidence on the effectiveness of VNS for TRD also noted that "Although the FDA voted to approve VNS Therapy, a poll of committee members showed that approval was based on the safety of VNS Therapy rather than strong evidence of efficacy." In addition, the Executive Secretary of the June 15, 2005, panel informed Committee Staff that the June 15 meeting was "very unusual, emotional, not data driven," compared to more than a dozen panel meetings for which she was the executive secretary.

the type of data that Cyberonics's did for FDA review and approval of a drug, CDER would not have filed that sponsor's application. In that e-mail, the psychopharmacology expert in CDER who reviewed initial materials from the sponsor wrote:

I am concerned that we are not getting our point across that the VNS for depression package that we reviewed represents a failed development program on face and that we would not file this as an NDA [New Drug Application<sup>65</sup>] if it were a drug. We realize that you may have a different threshold for approval when it comes to devices because of the nature of the different diseases on which our respective Divisions are asked to comment. However, we tend to view treatments for depression based on the disease and not on the therapeutic modality (psychotherapy, drug, ECT and now VNS). So it is artificial to us to consider one study for a device (that is negative on face) as sufficient to provide evidence for regulatory efficacy when we require positive studies for a drug.<sup>66</sup>

The CDER expert added that:

The long term claims [of efficacy by the sponsor] are based on open-label data. We do not allow labeling claims based [on] open label studies that rely on historical controls in depression. Historical controls in depression are extremely unreliable.<sup>67</sup>

The FDA review team leader informed Committee Staff that the team was puzzled by the CDRH Director's decisions to proceed with each stage of the review of the sponsor's PMA-S despite the team continuously recommending that the FDA not approve the VNS Therapy System for TRD. According to the team leader and DGRND Director, the team recommended non-approval prior to the 100-day meeting, because the team did not believe the sponsor would be able to address the limitations of the clinical data provided in the PMA-S. The team leader and DGRND Director explained that the review team believed that the device could not be approved without the sponsor conducting a new randomized, controlled study to demonstrate effectiveness. Throughout the review of the sponsor's PMA-S, DGRND recommended to the sponsor that it conduct such a study prior to approval. However, the sponsor insisted each time that it was unnecessary and unethical to conduct such a study, at least not before FDA approval of the device.<sup>68</sup>

<sup>65</sup>The vehicle through which drug manufacturers seek the FDA's approval of a new drug for sale and marketing in the U.S.

<sup>66</sup>See Appendix F.

<sup>67</sup>Ibid.

<sup>68</sup>According to an e-mail dated February 4, 2004, from a review team member to the team leader and Branch Chief, "Cyberonics spent an hour telling why it was completely impossible for them to do a placebo controlled long-term (or short-term) study . . . but then, completely out of the blue, promised that if we approved the device that they would do such a study post approval. I find this offer extremely puzzling since their argument centered around troubles with ethics, IRB cooperation, and patient recruitment. These are definitely not problems that would go away post approval." See Appendix F.

The team leader and DGRND Director acknowledged that randomized, controlled studies are not always required for FDA approval of devices, but the review team believed in the case of the VNS Therapy System, a randomized, controlled trial was necessary in order to distinguish improvement that is attributable to VNS Therapy from improvement that is attributable to other reasons, specifically, a placebo response or antidepressant treatments taken concurrently with VNS Therapy.<sup>69</sup> Nevertheless, Committee Staff were told that the CDRH Director, who was the ODE Director at the time, instructed the team to issue a major deficiency letter instead of a not approvable letter. The team leader said that the review team was surprised that the then-ODE Director would suggest a major deficiency letter without examining the sponsor's data. The CDRH Director, however, told Committee Staff that he asked for a deficiency letter because he prefers giving sponsors "a second bite at the apple," to address concerns.

The team leader and DGRND director stated that, after reviewing the sponsor's response to the major deficiency letter, the review team concluded that the sponsor had not addressed all of the deficiencies in its PMA-S and could not do so without conducting a new study. Consequently, the review team recommended that the device not be approved. Once again, the team was told to proceed with an advisory panel meeting to obtain recommendations on whether or not the FDA should approve the device. The DGRND Director told Committee Staff that she expressed her concerns to the then-ODE Director about convening an advisory panel, asking him what the FDA would do if the panel recommended approval despite the lack of sufficient effectiveness data, which is what occurred at the panel meeting. The then-ODE Director told Committee Staff that if the panel had agreed with the review team's assessment of the sponsor's clinical data, the panel's recommendation would provide additional support for a not approvable decision.

According to the ODE Deputy Clinical Director, soon after the June 15, 2004, advisory panel meeting, the ODE Director asked him to review the sponsor's application to advise her on whether or not the office should approve the VNS Therapy System for TRD. The Deputy Clinical Director informed Committee Staff that he was not initially involved in the review of the sponsor's PMA-S. He reviewed the transcript of the advisory panel meeting, the PMA-S file, and the review team's memoranda and supported DGRND's recommendation to not approve the device for TRD. In addition, after the not approvable letter was issued on August 11, 2004, the Deputy Clinical Director requested and reviewed additional patient response data from the sponsor and concluded in an e-mail to the ODE Director dated September 14, 2004:

---

<sup>69</sup>Even before the sponsor submitted its PMA-S in October 2003, the DGRND Director had expressed concerns about the sponsor being able to demonstrate effectiveness after the failure of the sponsor's D-02 acute phase to show a difference in responses between those receiving VNS Therapy and those who were not. According to minutes from a meeting between the sponsor and the FDA on March 1, 2002, the DGRND Director stated that she was not convinced that the sponsor would not need a randomized, long-term study to demonstrate effectiveness. About two weeks prior to the sponsor's submission of the PMA-S, the FDA reiterated concerns about the data limitations during a conference call with the sponsor. See October 11, 2002, conference call minutes. See Appendix H for the March and October 2002 minutes.

I do not see anything in the information which would convincingly make me decide to overrule the original Division/Office decision.<sup>70</sup>

Committee Staff were informed that the team leader as well as the DGRND, ODE, and CDRH Directors received hundreds of letters and phone calls opposing the FDA's August 11, 2004, decision to not approve the device for treatment-resistant depression. FDA staff interviewed by Committee Staff stated that interactions with the sponsor were not collegial<sup>71</sup> and the company was more aggressive than other sponsors in pursuing FDA approval. According to the CDRH Director and Ombudsman, the sponsor also spoke with staff in the Office of the Secretary, Department of Health and Human Services, who in turn followed up with CDRH regarding the FDA's not approvable letter. As a result of the influx of letters and phone calls after the not approvable letter was issued, the CDRH Director informed Committee Staff that he kept then-FDA Commissioner Lester Crawford apprised of developments in the review of the sponsor's PMA-S during his bi-weekly meetings with the Commissioner.

On September 23, 2004, the sponsor submitted its Amendment, in response to the not approvable letter. The review team examined the data and information provided in the sponsor's Amendment submission and, on November 10, 2004, concluded that the not approvable decision should stand. However, according to the review team leader and the DGRND and ODE Directors, the CDRH Director decided to schedule a meeting with the sponsor in December 2004 to further discuss the sponsor's Amendment and what the sponsor could do to enable the FDA to reach approval of the VNS Therapy System for TRD. Only four members of the review team were invited to attend the meeting, and according to the team leader and DGRND Director, management staff were not invited to participate in the meeting.

When the Restorative Devices Branch Chief learned that the CDRH Director planned to hold a meeting with the sponsor that would not include the management staff involved in the sponsor's PMA-S review—the branch chief, the deputy division director, and the division director—he expressed his concerns to the team leader. In an e-mail dated November 24, 2004, he wrote:

Don't know if you heard yesterday, but [the CDRH Director] has made a decision—of sorts. His plan is to have a meeting with the sponsor and the partial review team, for us to explain again why we came out to a different conclusion with the same data. I'll be meeting with [the ODE Director] today, and explain why I think that's a really bad idea, but chances are that's what'll happen.<sup>72</sup>

The CDRH Director stated to Committee Staff during his interview that the management staff were not intentionally excluded.

<sup>70</sup> See Appendix F.

<sup>71</sup> According to the CDRH Director, DGRND's interactions with the sponsor were "terrible" and the staff felt "abused" in meetings with the sponsor. The ODE Director informed Committee Staff that she spoke with the Chief Executive Officer of Cyberonics at the end of a meeting and requested that he refrain from yelling at her review team.

<sup>72</sup> See Appendix F.

However, only the team leader and three other members of the review team were invited—a medical officer, the CDER psychopharmacology expert, and the ODE Deputy Clinical Director. The review team leader informed Committee Staff during an interview that he felt “outnumbered” by the sponsor’s representatives. In addition, he wrote in his e-mail response to the Branch Chief dated November 29, 2004, that he was very troubled about the decision to hold a meeting without management and said such a meeting seemed “highly irregular.” See Appendix F.

The CDER psychopharmacology expert on the review team also expressed his concern regarding the December 2004 meeting when he was told to limit his comments to the sponsor’s clinical data and not discuss what types of studies CDER or the Center for Biologics Evaluation and Research would require for approval. He stated in an e-mail dated November 24, 2004:

I am a little troubled by what appears to be a request that I not discuss the need for replicated controlled data in our upcoming discussion with Cyberonics and [the CDRH Director]. I am left with the impression that you may view our Division’s opinion on the need for replicated controlled trial data as simply a bureaucratic policy difference between Centers. . . . This need for replicated controlled clinical trial data is a basic tenet of psychiatric clinical research. This need is based on sad experience. I suggest that the need for two randomized controlled trials should actually be the focus of this upcoming meeting.<sup>73</sup>

According to the CDRH Director and the Deputy Commissioner for Operations, the CDRH Director sought the Deputy Commissioner’s advice on how to proceed with the review of the VNS Therapy System for TRD because of the Deputy Commissioner’s expertise on antidepressants. During an interview with Committee Staff, the CDRH Director stated that he and the Deputy Commissioner discussed ways to obtain more data on the device, such as requesting the sponsor to conduct additional studies pre- or post-approval; however, the Deputy Commissioner did not advise him to approve or not approve the device. When he asked her impression of the sponsor’s VNS Therapy for TRD, he said she was “lukewarm” about the device. According to the CDRH Director, the Deputy Commissioner said there could be something there, but the studies were flawed.

The Deputy Commissioner also informed Committee Staff that she spoke with the Director of the Office of Medical Policy regarding potential studies that the sponsor could conduct to generate more effectiveness data on its device. She suggested to the CDRH Director a “randomized withdrawal” study, *i.e.*, randomly withdrawing VNS treatment from D-02 patients that the sponsor labeled as “responders.” According to the Deputy Commissioner, if the device works, the sponsor should observe a relapse in patients when their treatment is withdrawn. Alternatively, because patients usually can tell if the device is on, she suggested randomly reducing the output of the stimulator rather than fully withdrawing

---

<sup>73</sup>See Appendix F.

treatment. By e-mail dated December 23, 2004, the Director of the Office of Medical Policy also suggested to the CDRH Director a study that the sponsor “can and should do,” a randomized withdrawal study.<sup>74</sup> However, he questioned whether or not the sponsor could “realistically” conduct such a study post-approval.<sup>75</sup> The Deputy Commissioner informed Committee Staff that the FDA received “push back” from the sponsor on the proposal.

On July 28, 2005, the Chairman and Ranking Member sent a letter to the FDA to question why the FDA’s website did not address the level of scientific dissent within CDRH regarding the review and approval of the VNS Therapy System for TRD. FDA’s response, dated August 9, 2005, states:

The absence from the SSE of any discussion of internal discussions and the decision-making process that led to the approval reflects the policy of the Agency not to disclose pre-decisional and deliberative process information. . . . The reasons for this policy are to encourage open and frank discussions among colleagues and between subordinates and superiors at FDA and to protect against public confusion that might result from disclosure of reasons and rationales that were not in fact ultimately the grounds for the Agency’s decision.<sup>76</sup>

A review of whether or not the FDA uniformly adheres to this policy, however, shows that enforcement of the policy appears to depend on the interests of FDA management rather than any stated interest in encouraging scientific debate or in protecting the public. The Committee Staff are aware of more than one instance in recent years where the FDA has forthrightly publicized internal dissent regarding safety and effectiveness.

While Committee Staff recognize that it is not uncommon for FDA reviewers to disagree about the findings and conclusions regarding the safety and/or effectiveness of a drug or device, the level of dissent regarding the approval of the VNS Therapy System for TRD goes far beyond that of “open and frank discussions.” As the CDRH Director acknowledged to Committee Staff prior to his decision to approve the device, if he approved the device, the public would not be aware of his decision to overrule more than 20 FDA staff.

<sup>74</sup> See Appendix F.

<sup>75</sup> By letter dated July 7, 2005, Chairman Grassley and Ranking Member Baucus asked the FDA whether or not an agreement or understanding was reached between the sponsor and the FDA regarding FDA approval of VNS Therapy for TRD if the sponsor agreed to voluntarily withdraw VNS Therapy for TRD should post-marketing studies fail to show efficacy. The FDA provided its response on July 20, 2005. See Appendix E. In that response, the FDA noted that “consideration of post-market controls is an important component of FDA’s Pre-Market Approval program for devices.” The FDA also stated that “there exists no agreement or understanding between FDA and Cyberonics, written or oral,” and “such an agreement or understanding between FDA and Cyberonics has never been discussed.” However, given the FDA’s post-market authorities, “studies agreed to by Cyberonics do not reflect an inappropriate agreement by the Agency to permit the marketing of a device in exchange for a promise of withdrawal should the studies show the device to be ineffective.”

<sup>76</sup> See Appendix E.

*C. Not All Relevant Findings and Conclusions Regarding Safety and Effectiveness of the Device Were Made Publicly Available*

Through its website, the FDA has made available to the public the approval letter for the VNS Therapy System for TRD, the Summary of Safety and Effectiveness (Summary), physician and patient labeling information for the device, and other information for consumers. The Committee Staff reviewed these materials as well as other information and documents obtained by and provided to the Committee from the FDA and the sponsor. Based on that review, the Chairman and Ranking Member questioned, by letter dated July 28, 2005, the FDA's decision not to disclose certain information regarding the effectiveness of the VNS Therapy System that appears relevant to those who are considering having this device implanted.<sup>77</sup>

In the July 28, 2005, letter, the Chairman and Ranking Member noted that during an interview conducted with the CDRH Director, prior to approval of the VNS Therapy System for TRD, the Director acknowledged that data from the only randomized, controlled study, the acute phase of D-02, failed to demonstrate the effectiveness of the VNS Therapy System for TRD. The Director's internal override memorandum dated June 12, 2005, states:

With regard to effectiveness, I think it needs to be stated clearly and unambiguously that the short-term randomized comparison of VNS active to VNS sham<sup>78</sup> at 12 weeks failed to reach, or even come close to reaching, statistical significance with respect to its primary endpoint. I think that one has to conclude that, based on that data; either the device has no effect, or, if it does have an effect that in order to measure that effect a longer period of follow-up is required.<sup>79</sup>

However, the Director's comments regarding the effectiveness of the VNS Therapy System for TRD are absent from the Summary that is posted on the FDA's website. The Chairman and Ranking Member also noted in the July 28, 2005 letter to the FDA that the patient labeling of the VNS Therapy System for TRD does not make clear the Director's own conclusions regarding the sponsor's short-term clinical study. Instead of stating "clearly and unambiguously" that the "[VNS Therapy System for TRD] has no effect, or, if it does have an effect that in order to measure that effect a longer period of follow-up is required," the patient labeling for the VNS Therapy System for TRD states:

At the end of the first 3 months, the proportion of patients who had at least a 50 percent reduction in depression symptoms was 15 percent in the group of patients receiving active stimulation, slightly better than for patients who were not receiving stimulation (10 percent of these patients had at least a 50 percent reduction in symptoms).

<sup>77</sup> See Appendix A.

<sup>78</sup> A "sham" is used to resemble a treatment without actual use of the treatment. A placebo is an example of a sham control.

<sup>79</sup> See Appendix B.



. . . This finding suggested that the full effects of VNS Therapy might require more than 3 months of treatment.<sup>80</sup>

On August 9, 2005, the FDA responded to the Committee and cited a different section of the patient labeling to show that the labeling acknowledges “the failure of the data to demonstrate short-term effectiveness.”<sup>81</sup> The labeling states that “the 12 week acute studies did not show a significant difference between patients receiving VNS Therapy and those not receiving it.” However, it does not explain that “did not show a significant difference” means that any differences observed between the two groups of patients could have been due to chance rather than a response to the device. Because it could not be determined if the effect of the device was real or due to chance, the CDRH Director concluded in his override memorandum that, based on the results of the short-term study, a longer study would be needed to determine whether or not the device is effective.

In response to the Chairman and Ranking Member, the FDA also stated that it would review the CDRH Consumer Information webpage ([www.fda.gov/cdrh/mda/docs/p970003s050.html](http://www.fda.gov/cdrh/mda/docs/p970003s050.html)) regarding the approval of the VNS Therapy System for TRD to determine whether or not it could be revised to provide more helpful information to patients. By e-mail dated August 23, 2005, the FDA notified Committee Staff that it had revised its webpage. The current webpage, updated on August 12, 2005, includes additional information on when the device can be used:

The device is to be used only in patients 18 years of age or over with treatment-resistant depression (TRD). These are patients who have been treated with, but failed to respond to, at least 4 adequate medication and/or ECT treatment regimens prescribed by their physician. It is not intended to be used as a first-line treatment, even for patients with severe depression.<sup>82</sup>

The FDA also added information regarding what the VNS Therapy System is intended to accomplish. Specifically, the CDRH Consumer Information webpage on VNS Therapy states:

Based on the results of a clinical study of over 200 patients conducted in the United States, during the first 3 months of therapy, patients who had the device implanted and turned on did not show any significant advantage in response compared to patients in whom the device was implanted but not turned on.

The additional information regarding the short-term effectiveness data is similar to what is provided in the patient labeling. However, as presented, the information does not represent the gravity of the statement made by the CDRH Director in his override memorandum that the short-term study “failed to reach, or even come close to reaching, statistical significance with respect to its primary endpoint [of efficacy].” Nor does it represent the conclusions of the review team or the management staff at the branch,

<sup>80</sup> See Appendix D.

<sup>81</sup> See Appendix E.

<sup>82</sup> See Appendix B.

division and office levels who found the sponsor's data on the effectiveness of the VNS Therapy System for TRD to be "weak" and insufficient for FDA approval of the device.

In addition, because the review team's own assessment of the safety and effectiveness of the device is not available to the public, patients and physicians are not made aware of the reviewers' concerns regarding the safety of the VNS Therapy System for TRD in light of the team's conclusion that the device has not been shown to be effective. The review team stated in its final review memorandum dated January 6, 2005, "any safety risk associated with using a long-term implant, in the absence of a reasonable assurance of effectiveness data, is excessive."<sup>83</sup> The FDA review team also believed that the sponsor did not provide a reasonable assurance of safety because the safety data provided in the PMA-S did not allow an accurate assessment of any increased risks of using the device for TRD.

In the Preamble to a final rule on drug and biological products labeling, the FDA recently stated:

The centerpiece of risk management for prescription drugs generally is the labeling, which reflects thorough FDA review of the pertinent scientific evidence and communicates to health care practitioners the agency's formal, authoritative conclusions regarding the conditions under which the product can be used safely and effectively in accordance with the act. . . .

As FDA has long recognized, its role is not to regulate medical practice. The agency's actions nevertheless affect medical practice in a variety of ways. For example, FDA approval decisions affect the availability of drugs and medical devices. Also, FDA decisions as to the content and format of prescription drug labeling affect health care practitioner communications with patients, to the extent such labeling is relied upon by such practitioners to guide their discussions of risk with patients. FDA strongly believes that health care practitioners should be able to rely on prescription drug labeling for authoritative risk information and that health care practitioners should not be required to convey risk information to patients that is not included in the labeling.<sup>84</sup>

While these statements were made with respect to labeling for drug and biological products, they have implications for how and what information might be conveyed in device labeling. The FDA's position is that health care providers and their patients should be relying on the FDA for "authoritative risk information." However, the questionable aspects of the agency's regulatory approval process as evidenced in this Report suggest that health care providers relying on the FDA's authoritative information may not be able to convey complete risk information to their patients on the safety and effectiveness of the VNS Therapy System, because not all of

<sup>83</sup> Final review memorandum, *see* Appendix D, p. 207.

<sup>84</sup> "Requirements on Content and Format of Labeling for Human Prescription Drug and Biological Products," 71 Fed. Reg. 3922, 3969. (January 24, 2006).

the relevant findings and conclusions regarding this device have been made available.

Then-FDA Commissioner Crawford testified on July 26, 2005, before the House of Representatives Committee on Appropriations Subcommittee on Agriculture, Rural Development, Food and Drug Administration, and Related Agencies that he would make the FDA “a much more open and transparent organization.” This pledge has been reiterated by the FDA in letters to the Committee on other matters. However, selective disclosure of the FDA’s findings and conclusions regarding the safety and effectiveness of a device, in this case the VNS Therapy System for TRD, appears inconsistent with that pledge.

## **VI. Concluding Observations**

The public relies on the FDA to weigh the risks and benefits of a new medical device or a new indication for a device to determine whether or not the device is reasonably safe and effective for use. FDA approval has long been considered the gold standard. However, the events and circumstances surrounding the FDA’s review and approval of the VNS Therapy System for TRD—including the rare involvement of the CDRH Director and other high level FDA officials in the review of a device; the insistence of a single official to continue review of the PMA-S despite the repeated recommendations of over 20 FDA scientists, medical officers, and management staff to not approve the device throughout approximately 15 months of review; a “highly irregular” meeting between the sponsor and the FDA; and external pressure from the sponsor as well as hundreds of health care providers and TRD patients through letters, e-mails and phone calls—raise legitimate questions about the FDA’s decision to approve that device for the treatment of TRD. In light of the significant scientific dissent within the FDA regarding the effectiveness of the VNS Therapy System for TRD and the conclusion not only of the review team for the sponsor’s PMA-S but also of high level officials in the FDA that the effectiveness data were weak, concerns persist that the FDA’s standard of reasonable assurance of effectiveness may not have been met.

The FDA has standards for approval that must be met so that there is some assurance that the products approved for commercial distribution are safe and effective when used as directed in the product labeling. As a result of the short lifespan of new devices, different standards for demonstrating effectiveness may apply for devices compared to drugs. An approved device can quickly be replaced by a newer model or by smaller, better, and more sophisticated devices. However, what remains the same in FDA’s approval of a device or a drug is the requirement that data supporting a sponsor’s application for approval be scientifically sound. Otherwise health care providers and insurers as well as patients may question the integrity and reliability of the FDA’s assessment of the safety and effectiveness of an approved product. In the case of VNS Therapy for TRD, the FDA review team for the sponsor’s PMA-S believed that conducting a new randomized, controlled study would be the only way that the sponsor could address the data limitations in its PMA-S and repeatedly recommended that the sponsor con-

duct the study prior to approval. However, the sponsor refused to conduct another randomized, controlled study pre-approval.

FDA approval does not mean that a device is risk-free or that it will work in every patient. The determination of a medical device's safety and effectiveness prior to approval is based largely on studies that are conducted in small populations. While valuable information about the effectiveness of a device can be gained and new risks are sometimes identified once the device is on the market and used by millions of people, the FDA should not be making devices available to the public if those devices have not reached the agency's standard for safety and effectiveness. With respect to the VNS Therapy System for TRD, however, it appears that instead of relying on the comprehensive scientific evaluation of its scientists and medical officers, the FDA lowered its threshold for evidence of effectiveness. The FDA approved the VNS Therapy System for TRD based on what its own reviewers considered to be weak data and allowed the sponsor to test its device post-approval, contrary to the recommendations of the review team.

In addition to questions about the effectiveness of VNS Therapy System in the population for which the device is intended, concerns exist about the potential off-label uses of the device. Because the FDA does not regulate the practice of medicine, once a device is on the market, it is available for widespread use. While there have been benefits derived from off-label uses, the safety and effectiveness of off-label uses are not known and therefore can pose serious health risks to patients. The circumstances are no different for the VNS Therapy System for TRD. The specific public safety concern related to off-label use of this device is the implantation of the device in children with TRD. For example, the VNS Therapy System for epilepsy is approved only for use in patients 12 years of age or older, but off-label use of the device has occurred in children as young as five years of age. There are risks with using the VNS Therapy System in children that do not exist among adults because implantation of the device involves wrapping a wire around the nerve of a growing child. In the case of TRD, the VNS Therapy System is approved only for patients 18 years of age or older.

The level of scientific dissent within the FDA regarding the effectiveness of the VNS Therapy System for TRD also raises concerns about the use of taxpayer dollars to pay for a \$25,000 device, including implantation and programming, that over 20 FDA scientists, medical officers, and management staff believed should not be approved for the treatment of TRD. Whether or not a device is effective is not only a major public safety concern, but also a very important financial concern. The Medicare and Medicaid programs pay for health care services received by millions of Americans, so the Committee has a responsibility to ensure that the programs pay for medical devices approved based not on an abstract estimation of safety and effectiveness but on a comprehensive scientific evaluation of the product's benefits and risks, in accordance with all laws and regulations.

In addition, patients and their doctors, including Medicare and Medicaid beneficiaries, should have access to all relevant findings and conclusions regarding the safety and effectiveness of a device. The CDRH Director acknowledged during a media briefing on Feb-

ruary 2, 2006 that one of the FDA's "biggest challenges is in terms of providing useful information, and we understand that a lot of the concerns that have been raised over the course of the last few months to a year is with regard to the information that we present—the quantity of information and the timeliness of that information." Concerns remain about the lack of transparency regarding the approval process for the VNS Therapy System, which deprives doctors and their patients of information that may be relevant to a patient's care. All relevant findings and conclusions regarding the safety and effectiveness of the VNS Therapy System for TRD should be made available to patients and their doctors to enable them to make fully informed health care decisions and ensure all risks and benefits can be carefully weighed by those considering having the device implanted.



## **VII. LIST OF ACRONYMS**

CDER	Center for Drug Evaluation and Research
CDRH	Center for Devices and Radiological Health
CGMP	Current Good Manufacturing Practices
CPT	Current Procedural Terminology
DGRND	Division of General, Restorative and Neurological Devices
ECT	electroconvulsive therapy
FDA	Food and Drug Administration
HSRD	Hamilton Rating Scale for Depression
IDE	Investigational Device Exemption
IDS-SR	Inventory of Depressive Symptomatology-Self-Report
NDA	New Drug Application
ODE	Office of Device Evaluation
PMA-S	pre-market approval application supplement
TEC	Technology Evaluation Center
TRD	treatment-resistant depression
VNS	Vagus Nerve Stimulation





## VIII. GLOSSARY

**Approvable:** An application for pre-market approval of a medical device substantially meets the requirements of the Food and Drug Administration's regulations on the approval of medical devices (Part 814 of Title 21 of the Code of Federal Regulations), and the Food and Drug Administration believes it can approve the application if specific additional information is submitted or the applicant agrees to specific conditions.

**Arm:** The treatment or intervention groups in a clinical trial are referred to as trial or study arms.

**Clinical trial/clinical study:** An experimental study to answer specific questions about new therapies or new ways of using known treatments in people. Clinical trials are used to determine whether or not new drugs or treatments are both safe and effective.

**Comparative study:** A study in which the investigative drug or treatment is compared against another study treatment or placebo (see definition of placebo).

**Control:** Individuals who participate in a study and receive a standard treatment or no treatment that is compared with the experimental treatment.

**Controlled study:** A study in which one group of patients is given an experimental treatment, while another group, the control group, is given standard treatment or a placebo (see definition of placebo).

**Double-blind:** Neither the patients nor the study investigators knows which patients are receiving the experimental drug and which are receiving a placebo or another therapy.

**Electroconvulsive therapy:** A type of shock therapy that involves a brief electrical shock that is applied to the head to induce a short seizure.

**Indication:** A symptom or medical condition that leads to the recommendation of a test, drug, medical device, or other treatment. The term also refers to uses for which a treatment, test or procedure has been approved by the Food and Drug Administration.

**New Drug Application (NDA):** The vehicle through which drug manufacturers seek the Food and Drug Administration's approval of a new drug for sale and marketing in the U.S.

**Not approvable or non approvable:** The Food and Drug Administration determines that the data provided in an application for pre-market approval of a medical device is insufficient to establish that there is a reasonable assurance that the device is safe and effective for the use(s) specified in the application.

**Observational study:** A study in which patients taking one kind of drug or other medical treatment are compared against patients using an alternative drug or treatment.

**Off-label use:** A drug or treatment prescribed for conditions other than those that are approved by the Food and Drug Administration.

**Open label study:** A study in which doctors and participants know which drug or treatment is being administered. An open-label study does not use placebos.

**Pilot study:** A small study conducted in advance of a large one to test the feasibility of a large study or various doses of the study drug.

**Placebo:** An inactive substance or treatment against which investigational treatments are compared for efficacy and safety.

**Placebo-controlled study:** A study in which an inactive substance or treatment (placebo) is given to one group of patients, while the treatment being tested is given to another group. The results obtained in the two groups are then compared to see if the investigational treatment is more effective in treating the condition.

**Placebo effect:** A physical or emotional change, occurring after a substance is taken or treatment is administered, that is not the result of any special property of the substance or treatment. For example, patients who think that they are receiving a promising experimental treatment may have a psychological benefit from this knowledge and appear to improve even if the treatment itself is not effective.

**Pre-market approval application (PMA):** The vehicle through which medical device manufacturers seek the Food and Drug Administration's approval of a new device for sale and marketing in the U.S.

**Pre-market approval application supplement (PMA-S):** After the Food and Drug Administration grants an applicant a license to market a particular medical device, the applicant is required to file supplements to the original pre-market approval application (PMA) for all changes that affect the safety and effectiveness of the device, such as submitting a PMA-S to obtain the agency's approval of a new use for the device.

**Post-market study:** A clinical study that is conducted after a drug or treatment has been approved for marketing by the Food and Drug Administration, such as studies of new uses, new safety risks, and comparisons with other treatments.

**Randomized study:** A study in which participants are randomly assigned to one of two or more treatment arms or regimens of a study.

**Serious adverse event:** An adverse event that is fatal, life-threatening, permanently disabling, or results in hospitalization.

**Sham:** Used to resemble a treatment without actual use of the treatment. A placebo is an example of a sham control.

**Sponsor:** Under 21 C.F.R. § 3.2, this term has the same meaning as “applicant,” any person who submits or plans to submit an application to the FDA for pre-market review. The sponsor is usually the manufacturer of the product under review. Under 21 C.F.R. § 812.3, a sponsor is also a person who initiates the clinical studies to determine the safety or effectiveness of a device.

**Statistical significance:** The probability that a result or difference observed during a study did not occur by chance alone. In general, a difference between two groups (*e.g.*, investigational treatment vs. standard treatment, investigational treatment vs. placebo) is considered statistically significant if chance could explain the difference only 5% of the time or less.

**Valid scientific evidence:** Consists principally of well-controlled clinical investigations, which include assigning study subjects to tests groups that can be compared. The Food and Drug Administration regulations specify four types of controls to which subjects receiving the treatment under investigation can be compared: (1) no treatment; (2) placebo control; (3) active treatment control, *i.e.*, comparison to an effective treatment; and (4) historical control, *i.e.*, comparison to a group of patients receiving no treatment or an established effective regimen who were observed at a previous time. (21 C.F.R. § 860.7(f))



**IX. TIMELINE OF MAJOR EVENTS RELATED TO CYBERONICS'S PMA-SUPPLEMENT FOR THE VAGUS NERVE STIMULATION THERAPY SYSTEM**

<b>DATE</b>	<b>EVENT</b>
October 27, 2003	Sponsor submits Vagus Nerve Stimulation Therapy System (VNS Therapy System) pre-market approval application supplement (PMA-S) for new indication, treatment-resistant depression (TRD)
January 28, 2004	FDA teleconference with sponsor to review status of PMA-S
February 4, 2004	100-day meeting between FDA and sponsor regarding PMA-S
March 4, 2004	FDA sends sponsor major deficiency letter
June 15, 2004	Neurological devices panel meeting (5-2 vote in favor of approvable with specific conditions)
August 11, 2004	FDA issues not approvable letter
September 10, 2004	Sponsor submits Treatment Investigational Device Exemption (Treatment IDE) application to FDA
September 15, 2004	Meeting between sponsor and FDA's Office of Device Evaluation (ODE) to discuss reconsideration of not approvable decision and provision of additional data
September 23, 2004	Meeting between sponsor and senior officials of the FDA  Sponsor submits amendment to PMA-S
October 15, 2004	FDA approves Treatment IDE
November 10, 2004	FDA review team meeting to discuss sponsor's Amendment submission; team votes to recommend not approvable
November 19, 2004	ODE and review team brief Center for Device and Radiological Health (CDRH) Director regarding recommendation of not approvable
December 1, 2004	CDRH Director convenes meeting between sponsor and several members of FDA review team
December 22, 2004	FDA issues warning letter to sponsor after site inspection
January 6, 2005	Review team leader files final review memorandum, which documents review team's rationale for recommending not approvable
February 2, 2005	FDA issues approvable letter
July 15, 2005	FDA approves VNS Therapy System for TRD



## **X. APPENDICES**

A number of documents in the appendices to this Report to the Chairman and Ranking Member contain redactions. Publicly available documents were not redacted. To the extent possible, personal identifying information, including names, phone numbers and e-mail addresses, was redacted. In aid of clarity, then-titles of FDA officials and employees have been substituted for the redacted names in many FDA memoranda and e-mails. In response to an invitation from the Committee Staff, the FDA also marked for potential redaction documents or portions of documents, which the FDA had provided to the Committee, as the FDA would redact them if it were disclosing the documents publicly under the Freedom of Information Act (FOIA). All of the FDA's proposed redactions related to FOIA exemption 5: pre-decisional opinions, judgments or recommendations within inter-agency or intra-agency communications. The proposed redactions were considered and implemented wherever reporting of the facts and findings of the Report was not hindered by exclusion of the redacted information.





---

---

APPENDIX A—CHAIRMAN AND RANKING MEMBER  
LETTERS TO THE FDA

---

---

CHARLES E. GRASSLEY, IOWA, CHAIRMAN  
 ORIN G. HATCH, UTAH  
 TRENT LOTT, MISSISSIPPI  
 OLYMPIA J. SNOWE, MAINE  
 JON KYL, ARIZONA  
 CRAIG THOMAS, WYOMING  
 RICK SANTORUM, PENNSYLVANIA  
 BILL FRET, TENNESSEE  
 GORDON SMITH, OREGON  
 JIM BUNNING, KENTUCKY  
 MIKE CRAPO, IDAHO

MAX BAUCUS, MONTANA  
 JOHN D. ROCKEFELLER IV, WEST VIRGINIA  
 KENT CONRAD, NORTH DAKOTA  
 JAMES M. HOFFORDS II, VERMONT  
 JEFF BINGAMAN, NEW MEXICO  
 JOHN F. KERRY, MASSACHUSETTS  
 BLANCHIE L. LINCOLN, ARKANSAS  
 RON WYDEN, OREGON  
 CHARLES E. SCHUMER, NEW YORK

KOLAN DAVIS, STAFF DIRECTOR AND CHIEF COUNSEL  
 RUSSELL SULLIVAN, DEMOCRATIC STAFF DIRECTOR

## United States Senate

COMMITTEE ON FINANCE  
 WASHINGTON, DC 20510-6200

March 11, 2005

VIA FACSIMILE: (301) 827-1960  
ORIGINAL BY U.S. MAIL

Lester M. Crawford, D.V.M., Ph.D.  
 Acting Commissioner  
 U.S. Food and Drug Administration  
 5600 Fishers Lane  
 Rockville, MD 20857

Dear Dr. Crawford:

It has come to the attention of the Senate Committee on Finance (Committee) that the Food and Drug Administration (FDA) issued an approvable letter to Cyberonics, Inc. (Cyberonics) last month for the company's Vagus Nerve Stimulation Therapy System (VNS) to treat chronic or recurrent depression in adults despite allegedly strong objections from the FDA scientists involved in evaluating the safety and efficacy of that device. In addition, last August, the FDA rejected Cyberonics' pre-market application to use VNS for depression.

As Chairman and Ranking Member of the Committee, we request that the FDA make the following individuals available for an interview with our Committee staff within three weeks of the date of this letter:

- Director, FDA's Center for Devices and Radiological Health (CDRH)
- Director, Office of Device Evaluation (ODE), CDRH
- Director, Division of General, Restorative and Neurological Devices, ODE, CDRH
- Neuroscientist, Division of General, Restorative and Neurological Devices, ODE, CDRH

should be prepared to answer questions regarding the approvable letter and FDA's evaluation of VNS for chronic or recurrent depression. In addition, these individuals should be prepared to provide and discuss with the Committee all documents relating to or referring to the VNS and the issuance of the approvable letter. These documents include, but are not limited to, emails, diary notes,

meeting notes, telephone conversations, memoranda, and any other written communication. Please refer to the attached definitions concerning the production of documents.

Thank you in advance for your assistance. Please have your staff coordinate with my staff about this letter by no later than March 18, 2005.

Sincerely,



Charles E. Grassley  
Chairman



Mr. Baucus  
Ranking Member

CHARLES E. GRASSLEY, IOWA, CHAIRMAN  
 ORRIN G. HATCH, UTAH  
 TRENT LOTT, MISSISSIPPI  
 OLYMPIA J. SNOWE, MAINE  
 JON KYL, ARIZONA  
 CRAIG THOMAS, WYOMING  
 RICK SANTORUM, PENNSYLVANIA  
 BILL FRIST, TENNESSEE  
 JIM BURNINGHAM, KENTUCKY  
 MIKE CRAPO, IDAHO

KOLAN DAVIS, STAFF DIRECTOR AND CHIEF COUNSEL  
 RUSSELL SULLIVAN, DEMOCRATIC STAFF DIRECTOR

MAY BAUCUS, MONTANA  
 JOHN D. ROCKEFELLER IV, WEST VIRGINIA  
 KENT CONRAD, NORTH DAKOTA  
 JAMES M. JEFFORDS II, VERMONT  
 JEFF BLINGAMAN, NEW MEXICO  
 JOHN F. KERRY, MASSACHUSETTS  
 BLANCHE L. LINCOLN, ARKANSAS  
 RON WYDEN, OREGON  
 CHARLES E. SCHUMER, NEW YORK

## United States Senate

COMMITTEE ON FINANCE  
 WASHINGTON, DC 20510-6200

April 19, 2005

Via Facsimile: (301) 827-1960  
Original via U.S. Mail

Lester M. Crawford, D.V.M., Ph.D.  
 Acting Commissioner  
 U.S. Food and Drug Administration  
 5600 Fishers Lane  
 Rockville, MD 20857

Dear Dr. Crawford:

We appreciate your cooperation with the Committee on Finance's (Committee) request dated March 11, 2005, regarding the approvable letter that the Food and Drug Administration (FDA) issued to Cyberonics, Inc. (Cyberonics) on February 2, 2005, with respect to using its Vagus Nerve Stimulator (VNS) Therapy System to treat treatment-resistant depression (TRD) in adults. Recently, our Committee staff conducted interviews with the four FDA employees identified in our earlier letter, and the FDA responded in part to the Committee's document request.

The information provided to date does not resolve all of our questions about the FDA's handling of the Cyberonics' Panel-Track PMA-Supplement for VNS Therapy to treat TRD. Additional questions regarding the safety and efficacy of this treatment for this indication have been raised, and troubling questions remain as to whether sufficient evidence exists to support VNS Therapy as safe and effective for TRD.

During the interviews, additional FDA staff were identified who may have pertinent knowledge and information. As Chairman and Ranking Member of the Committee, we request that the FDA schedule Committee staff interviews with the following individuals during the course of the next three weeks. Please schedule the interviews to occur in the following order and provide curricula vitae in advance of the interviews:

1. Clinical Deputy Director, Office of Device Evaluation  
(ODE), CDRH
2. Ombudsman, CDRH
3. Chemist, ODE, CDRH
4. Acting Deputy Commissioner for Operations
5. Director of Scientific Policy Development, Office of the  
Commissioner

In addition, we understand that the FDA is still complying with the Committee's original document request. Moreover, during the interviews, a number of documents were discussed that we may not have specifically requested. Therefore, we request that the FDA include the following documentation as part of its response:

1. Copies of the major deficiencies letter dated March 4, 2004 issued to Cyberonics and Cyberonics' responses to that letter
2. Copies of investigations and analyses of deaths among patients who were enrolled in Cyberonics' clinical trials for use of VNS Therapy to treat TRD
3. June 15, 2004 panel review memo
4. FDA's letter and/or other responses to Cyberonics regarding Cyberonics' statistical plan to compare outcomes from an investigational device study (D02) and an observational control study (D04)
5. Cyberonics' Amendment 11 response to the August 11, 2004 not approvable letter
6. E-mail communications and minutes and/or summaries (all drafts and final versions) of all internal meetings between and among the review team, branch, division, office, and center management regarding VNS Therapy from October 27, 2003 through February 2, 2005
7. E-mail communications, documentation of phone calls, and minutes and/or summaries (all drafts and final versions) of all meetings between the FDA and Cyberonics' representatives and consultants from October 27, 2003 through April 15, 2005, including but not limited to the following meetings:
  - a. December 1, 2004 meeting between FDA's and Cyberonics' scientists
  - b. Meeting(s) between Acting Deputy Commissioner of Operations and CEO of Cyberonics, and other Cyberonics representatives
  - c. Meeting(s) between CDRH Director; CDRH Ombudsman; Cyberonics CEO; and Cyberonics General Counsel
8. Curricula vitae or resumes

Finally, we request that the FDA advise the Committee of its time frame for a final decision regarding the approval or non-approval of VNS Therapy for TRD.

We would appreciate the FDA's continued cooperation with these requests.

Thank you in advance for your assistance on this important matter. Please have your staff coordinate with our staffs by no later than April 25, 2005, to schedule the interviews, and please provide the requested materials no later than May 3, 2005.

Sincerely,

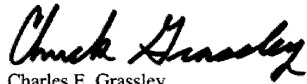

Charles E. Grassley  
Chairman



Max Baucus  
Ranking Member

CHARLES E. GRASSLEY, IOWA, CHAIRMAN

OPRIN G. HATCH, UTAH	MAX BAUCUS, MONTANA
TRENT LOTT, MISSISSIPPI	JOHN D. ROCKEFELLER IV, WEST VIRGINIA
OLYMPIA J. SNOWE, MAINE	KENT CONRAD, NORTH DAKOTA
JON KYL, ARIZONA	JAMES M. JEFFORDS II, VERMONT
CHRIS THOMAS, WYOMING	JEFF BINGAMAN, NEW MEXICO
RICK SANTORUM, PENNSYLVANIA	JOHN F. KERRY, MASSACHUSETTS
BILL PRIEST, TENNESSEE	BLANCHETT L. LINCOLN, ARKANSAS
GOPHON SMITH, OREGON	RON WYDEN, OREGON
JIM BUNNING, KENTUCKY	CHARLES E. SCHUMER, NEW YORK
MIKE CRAPO, IDAHO	

KOLAN DAVIS, STAFF DIRECTOR AND CHIEF COUNSEL  
 RUSSELL SULLIVAN, DEMOCRATIC STAFF DIRECTOR

United States Senate

COMMITTEE ON FINANCE  
 WASHINGTON, DC 20510-6200

May 17, 2005

Via facsimile: (301) 827-1960  
Original via U.S. Mail

Lester M. Crawford, D.V.M., Ph.D.  
 Acting Commissioner  
 U.S. Food and Drug Administration  
 5600 Fishers Lane  
 Rockville, MD 20857

Dear Dr. Crawford:

In addition to the materials we requested on March 11, 2005 and April 19, 2005, we request that the Food and Drug Administration (FDA) supply the following materials:

1. All adverse events evaluations related to Cyberonics, Inc.'s (Cyberonics) Vagus Nerve Stimulator (VNS)
2. Patient level data from Cyberonics' studies of patients with treatment-resistant depression implanted with VNS

We understand that the materials requested under #1 and #2 have already been forwarded to FDA's Office of Legislation. Please make them available to our Committee staff by May 20, 2005. Please also consider this and our previous requests for materials as ongoing and evolving. Therefore, we request that the FDA provide any documents or materials related to Cyberonics' Panel-Track PMA Supplement for VNS that were prepared or requested by the FDA after February 2, 2005 to our Committee staff as soon as they are available.

Thank you in advance for your assistance on this important matter.

Sincerely,



Charles E. Grassley  
 Chairman



Max Baucus  
 Ranking Member

CHARLES E. GRASSLEY, IOWA, CHAIRMAN  
 ORRIN G. HATCH, UTAH  
 TRENT LOTT, MISSISSIPPI  
 OLYMPIA J. SNOWE, MAINE  
 JON KYL, ARIZONA  
 GRAND THOMAS, WYOMING  
 RICK SANTORUM, PENNSYLVANIA  
 BILL PRIEST, TENNESSEE  
 GORDON SMITH, OREGON  
 JIM BUNNING, KENTUCKY  
 MIKE CRAPO, IDAHO

KOLAN DAVIS, STAFF DIRECTOR AND CHIEF COUNSEL  
 RUSSELL SULLIVAN, DEMOCRATIC STAFF DIRECTOR

MAX BAUCUS, MONTANA  
 JOHN D. ROCKEFELLER IV, WEST VIRGINIA  
 KENT CONRAD, NORTH DAKOTA  
 JAMES M. JEFFORDS II, VERMONT  
 JEFF BINGAMAN, NEW MEXICO  
 JOHN F. KERRY, MASSACHUSETTS  
 BLANCHE L. LINCOLN, ARKANSAS  
 RON WYDEN, OREGON  
 CHARLES E. SCHUMER, NEW YORK

# United States Senate

COMMITTEE ON FINANCE  
 WASHINGTON, DC 20510-6200

May 27, 2005

Via facsimile: (301) 827-1960  
Original via USPS Mail

Lester M. Crawford, D.V.M., Ph.D.  
 Acting Commissioner  
 U.S. Food and Drug Administration  
 5600 Fishers Lane  
 Rockville, MD 20857

Dear Dr. Crawford:

As part of our ongoing examination of the Food and Drug Administration's (FDA) handling of Cyberonics, Inc.'s Panel-Track PMA-Supplement for Vagus Nerve Stimulation Therapy to address treatment-resistant depression, we request that the FDA make available the members of the June 15, 2004 Neurological Devices Panel for interviews with our Committee on Finance staff. Our staff will coordinate with the FDA's Office of Legislation to schedule interviews.

Thank you in advance for your assistance.

Sincerely,

Charles E. Grassley  
 Chairman

Max Baucus  
 Ranking Member



CHARLES E. GRASSLEY, IOWA, CHAIRMAN	MAX BAUCUS, MONTANA
ORRIN G. HATCH, UTAH	JOHN D. ROCKEFELLER IV, WEST VIRGINIA
TRENT LOTT, MISSISSIPPI	KENT CONRAD, NORTH DAKOTA
OLYMPIA J. SNOWE, MAINE	JAMES M. HEFFORD III, VERMONT
JON KYL, ARIZONA	JEFF BINGAMAN, NEW MEXICO
CRAIG THOMAS, WYOMING	JOHN F. KERRY, MASSACHUSETTS
RICK SANTORUM, PENNSYLVANIA	BLANCHE L. LINCOLN, ARKANSAS
BILL FRET, TENNESSEE	RON WYDEN, OREGON
GORDON SMITH, OREGON	CHARLES E. SCHUMER, NEW YORK
JIM BUNNING, KENTUCKY	
MIKE CRAPO, IDAHO	

**United States Senate**  
 COMMITTEE ON FINANCE  
 WASHINGTON, DC 20510-6200

KOLAN DAVIS, STAFF DIRECTOR AND CHIEF COUNSEL  
 RUSSELL SULLIVAN, DEMOCRATIC STAFF DIRECTOR

July 7, 2005

Via Facsimile: (301) 827-1960  
Original via USPS Mail

Lester M. Crawford, D.V.M., Ph.D.  
 Acting Commissioner  
 U.S. Food and Drug Administration  
 5600 Fishers Lane  
 Rockville, MD 20857

Dear Dr. Crawford:

Under the Committee on Finance's (Committee) oversight authority, we are requesting that you provide the Committee with information relevant to the Committee's ongoing examination of the Food and Drug Administration's (FDA) handling of Cyberonics, Inc.'s (Cyberonics) Panel-Track PMA-Supplement for the Vagus Nerve Stimulation (VNS) Therapy to address treatment-resistant depression (TRD) in adults.

An allegation has come to the attention of the Committee that an agreement or understanding may exist between Cyberonics and the FDA regarding the FDA's review of VNS Therapy. The specific allegation suggests that an agreement or understanding was reached, either in writing or verbally, which provides, among other things, that the FDA would approve VNS Therapy for the indication of TRD if Cyberonics would agree to voluntarily withdraw VNS Therapy for TRD if post-marketing studies failed to show efficacy.

Please state whether any such agreement or understanding exists in any form whatsoever, and describe the terms of such agreement or understanding. If a written agreement or understanding exists, we request, as Chairman and Ranking Member of the Committee, that the FDA provide the Committee with a copy of the agreement or understanding, including all records and communications related to the written agreement or understanding. If the agreement or understanding was verbal, please describe in detail the terms and conditions of the agreement or understanding, and provide to the Committee all records and communications related to the verbal agreement or understanding. Finally, if an agreement or understanding was or is being discussed, we would also appreciate being so advised.

In conclusion, please state whether the FDA has ever entered into a similar agreement or understanding with any other sponsor and whether such agreements or understandings are common practice. Further, please explain in detail why such an

agreement or understanding with a sponsor is necessary if the FDA has sufficient authority to withdraw a device from the market that is deemed unsafe and/or ineffective.

Thank you in advance for your assistance. We would appreciate a response to our inquiries and document requests no later than July 21, 2005.

Sincerely,

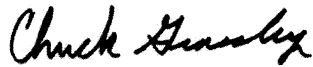

Charles E. Grassley  
Chairman



Max Baucus  
Ranking Member

CHARLES E. GRASSLEY, IOWA, CHAIRMAN  
 ORRIN G. HATCH, UTAH  
 TRENT LOTT, MISSISSIPPI  
 OLYMPIA J. SNOWE, MAINE  
 JON KYL, ARIZONA  
 CRAIG THOMAS, WYOMING  
 RICK SANTORUM, PENNSYLVANIA  
 BILL FRYE, TENNESSEE  
 GORDON SMITH, OREGON  
 JIM BUNNING, KENTUCKY  
 MIKE CRAPO, IDAHO

MAX BAUCUS, MONTANA  
 JOHN D. ROCKEFELLER IV, WEST VIRGINIA  
 KENT CONRAD, NORTH DAKOTA  
 JAMES M. JEFFORDS III, VERMONT  
 JEFF BINGAMAN, NEW MEXICO  
 JOHN F. KERRY, MASSACHUSETTS  
 BLANCHE L. LINCOLN, ARKANSAS  
 RON WYDEN, OREGON  
 CHARLES E. SCHUMER, NEW YORK

KOLAN DAVIS, STAFF DIRECTOR AND CHIEF COUNSEL  
 RUSSELL SULLIVAN, DEMOCRATIC STAFF DIRECTOR

## United States Senate

COMMITTEE ON FINANCE

WASHINGTON, DC 20510-6200

July 28, 2005

Via Facsimile: (301) 827-1960  
Original via USPS Mail

The Honorable Lester M. Crawford, D.V.M., Ph.D.  
 Commissioner  
 U.S. Food and Drug Administration  
 5600 Fishers Lane  
 Rockville, MD 20857

Dear Commissioner Crawford:

Since March, the Committee on Finance (Committee) has been reviewing the Food and Drug Administration's (FDA) handling of Cyberonics, Inc.'s (Cyberonics) Panel-Track PMA-Supplement for Vagus Nerve Stimulation Therapy to address treatment-resistant depression in adults (VNS Therapy System for TRD). We appreciate the FDA's cooperation with the Committee's review to date and request its continued cooperation.

Earlier this year, on February 16, 2005, the *Washington Post* reported that Secretary Michael Leavitt, Department of Health and Human Services, spoke before a gathering of FDA employees and announced: "The public has spoken, and they want more oversight and openness . . . [t]hey want to know what we know, what we do with the information and why we do it."

You were also quoted, as then acting Commissioner, saying, "I think we need to adopt the mentality that the public wants to know and the public needs to know, and we should find reasons to make information available, rather than simply saying we can't reveal trade secrets . . . 'closed case.'" As recently as Tuesday, in testimony before the House of Representatives Committee on Appropriations, you repeated your pledge to make the FDA "a much more open and transparent organization."

As the Chairman and Ranking Member of the Committee with responsibility to the more than 80 million Americans who receive health care coverage under Medicare and Medicaid, including payment for medical devices, we wholeheartedly agree with these statements and are greatly concerned when it appears that the FDA has not lived up to them.

On July 15, 2005, the FDA approved the VNS Therapy System for TRD and provided important approval information on its website, including the approval order, a

The Honorable Lester M. Crawford, D.V.M. Ph.D.  
July 28, 2005  
Page 2 of 3

summary of Safety and Effectiveness, and labeling information. Our Committee staff have reviewed the documents and information provided to the Committee, as well as the information the FDA has posted on its website. Based on that review, we question why the FDA has not disclosed other critical information regarding the effectiveness of VNS Therapy System for TRD, which appears highly relevant to those who are considering having this device implanted. In the interest of public health and safety, we encourage the FDA to disclose all information, findings and conclusions regarding the safety and effectiveness of the VNS Therapy System for TRD to enable patients and their health care providers to make fully informed health care decisions.

Specifically, the FDA review team responsible for evaluating the VNS Therapy System for TRD strongly disagreed with the decision to approve that device. In fact, the Director for the Center for Devices and Radiological Health (CDRH) overturned the entire team that reviewed the device, which consisted of more than twenty FDA scientists and medical officers, including neurosurgeons, neurologists, psychiatrists, statisticians, epidemiologists and adverse events analysts, as well as management from the branch, division and office levels of CDRH. The Director of CDRH decided independently to approve the VNS Therapy System for TRD and, therefore, was required to write the portion of an internal override memorandum that supported the conclusions and rationale behind his decision.

Prior to approval of the VNS Therapy System for TRD, our Committee staff had the opportunity to interview the Director of CDRH. The Director acknowledged that the data from the only randomized, controlled study submitted to the FDA by Cyberonics failed to demonstrate the effectiveness of VNS Therapy for TRD. Furthermore, the Director's internal override memorandum filed in support of approving the VNS Therapy System for TRD stated:

With regard to effectiveness, I think it needs to be stated clearly and unambiguously that the short-term randomized comparison of VNS active to VNS sham at 12 weeks failed to reach, or even come close to reaching, statistical significance with respect to its primary endpoint. I think that one has to conclude that, based on that data; either the device has no effect, or, if it does have an effect that in order to measure that effect a longer period of follow-up is required.

However, the Summary of Safety and Effectiveness posted on the FDA's website is silent with respect to the level of scientific dissent within CDRH. Moreover, the Director's own comments regarding the effectiveness of the VNS Therapy System for TRD are nowhere to be seen. Despite the fact that the Center Director overruled the entire FDA review team, the Summary of Safety and Effectiveness simply states that Cyberonics provided "reasonable assurance of safety and effectiveness" of the VNS Therapy System for TRD. Instead of stating "clearly and unambiguously" that the "[VNS Therapy System for TRD] has no effect, or, if it does have an effect that in order to

The Honorable Lester M. Crawford, D.V.M. Ph.D.  
July 28, 2005  
Page 3 of 3

measure that effect a longer period of follow-up is required," the patient labeling for the VNS Therapy System for TRD states:

At the end of the first 3 months, the proportion of patients who had at least a 50% reduction in depression symptoms was 15% in the group of patients receiving active stimulation, slightly better than for patients who were not receiving stimulation (10% of these patients had at least a 50% reduction in symptoms).... This finding suggested that the full effects of VNS Therapy might require more than 3 months of treatment.

If it is the FDA's policy to proactively disclose safety and effectiveness information to the public, please explain why the conclusions and rationale for approval of the VNS Therapy System for TRD are not publicly available in the Director's own clear and unambiguous language. Disclosing this information would appear to be consistent with your pledge to make the FDA more open and transparent.

We look forward to hearing from you promptly regarding the corrective actions the FDA will take to address the concerns and issues set forth in this letter. Given the seriousness of this matter and the apparent public safety concerns, we request that the FDA provide a response to the Committee no later than August 1, 2005.

Sincerely,



Charles E. Grassley  
Chairman



Max Baucus  
Ranking Member



---

---

APPENDIX B—APPROVAL AND LABELING INFORMATION  
POSTED ON FDA’S WEBSITE

---

---



DEPARTMENT OF HEALTH &amp; HUMAN SERVICES

Public Health Service

Food and Drug Administration  
9200 Corporate Boulevard  
Rockville MD 20850

JUL 15 2005

Ms. Annette Zinn, M.P.H., J.D., RAC  
Director and Senior Counsel, Regulatory Affairs  
Cyberonics, Inc.  
100 Cyberonics Boulevard  
Houston, TX 77058

Re: P970003/S50  
VNS Therapy System  
Filed: October 27, 2003  
Amended: December 4 and 19, 2003; February 17, March 18 and 29, April 5 and 8, July 7  
and 8, September 8 and 23, 2004; and March 11, and June 28, 2005  
Procure: MUZ

Dear Ms. Zinn:

The Center for Devices and Radiological Health (CDRH) of the Food and Drug Administration (FDA) has completed its review of your premarket approval application (PMA) supplement for the VNS Therapy System. This device is indicated for the adjunctive long-term treatment of chronic or recurrent depression for patients 18 years of age or older who are experiencing a major depressive episode and have not had an adequate response to four or more adequate antidepressant treatments. The PMA supplement is approved. You may begin commercial distribution of the device as modified in accordance with the conditions described below and in the "Conditions of Approval" (enclosed).

The sale, distribution, and use of this device are restricted to prescription use in accordance with 21 CFR 801.109 within the meaning of section 520(e) of the Federal Food, Drug, and Cosmetic Act (the act) under the authority of section 515(d)(1)(B)(ii) of the act. FDA has also determined that, to ensure the safe and effective use of the device, the device is further restricted within the meaning of section 520(e) under the authority of section 515(d)(1)(B)(ii), (1) insofar as the labeling specify the requirements that apply to the training of practitioners who may use the device as approved in this order and (2) insofar as the sale, distribution, and use must not violate sections 502(q) and (r) of the act.

In addition to the postapproval requirements outlined in the enclosure, you must conduct the following postapproval studies to further characterize the optimal stimulation dosing and patient selection criteria for the VNS Therapy System for treatment-resistant depression (TRD). The first study is a prospective, multicenter, randomized, double-blind comparison of different output currents in 450 new subjects with TRD. You have agreed to assess the effectiveness responses to differing outputs 16 weeks after the end of a 4-6 week titration period during which concomitant therapies will not be changed. You have also agreed to follow these subjects for at least one year following implantation to further characterize duration of response as well as safety parameters at



Page 2 - Ms. Annette Zinn, M.P.H., J.D., RAC

these higher doses. The second study is a prospective, observation registry study of 1000 implanted subjects with TRD with follow-up extending to 5 years after implantation. This study is designed to evaluate long-term patient outcomes as well as predictors of response to therapy. Post approval study progress reports and results will be submitted as a report to the PMA at 6 month intervals. As appropriate, CDRH may request panel review of the postapproval study data. When necessary, the results will be incorporated into the labeling, via a supplement.

CDRH does not evaluate information related to contract liability warranties, however you should be aware that any such warranty statements must be truthful, accurate, and not misleading, and must be consistent with applicable Federal and State laws.

CDRH will notify the public of its decision to approve your PMA by making available a summary of the safety and effectiveness data upon which the approval is based. The information can be found on the FDA CDRH Internet HomePage located at <http://www.fda.gov/cdrh/pmapage.html>. Written requests for this information can also be made to the Dockets Management Branch (HFA-305), Food and Drug Administration, 5630 Fishers Lane, rm. 1061, Rockville, MD 20852. The written request should include the PMA number or docket number. Within 30 days from the date that this information is placed on the Internet, any interested person may seek review of this decision by requesting an opportunity for administrative review, either through a hearing or review by an independent advisory committee, under section 515(g) of the Federal Food, Drug, and Cosmetic Act (the act).

Failure to comply with any postapproval requirement constitutes a ground for withdrawal of approval of a PMA. Commercial distribution of a device that is not in compliance with these conditions is a violation of the act.

You are reminded that, as soon as possible and before commercial distribution of your device, you must submit an amendment to this PMA submission with copies of all approved labeling affected by this supplement in final printed form. The labeling will not routinely be reviewed by FDA staff when PMA supplement applicants include with their submission of the final printed labeling a cover letter stating that the final printed labeling is identical to the labeling approved in draft form. If the final printed labeling is not identical, any changes from the final draft labeling should be highlighted and explained in the amendment.

All required documents should be submitted in triplicate, unless otherwise specified, to the address below and should reference the above PMA number to facilitate processing.

PMA Document Mail Center (HFZ-401)  
Center for Devices and Radiological Health  
Food and Drug Administration  
9200 Corporate Blvd.  
Rockville, Maryland 20850

Page 3 - Ms. Annette Zinn, M.P.H., J.D., RAC

If you have any questions concerning this approval order, please contact me at (301) 827-7975.

Sincerely yours,

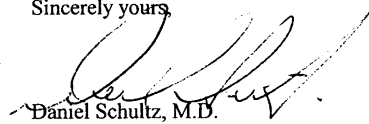
A handwritten signature in black ink, appearing to read "Daniel Schultz", written over a faint dotted line.

Daniel Schultz, M.D.  
Director  
Center for Devices and  
Radiological Health  
Food and Drug Administration

Enclosure

Last Modified: 1-31-02

## CONDITIONS OF APPROVAL

**PREMARKET APPROVAL APPLICATION (PMA) SUPPLEMENT.** Before making any change affecting the safety or effectiveness of the device, submit a PMA supplement for review and approval by FDA unless the change is of a type for which a "Special PMA Supplement-Changes Being Effectuated" is permitted under 21 CFR 814.39(d) or an alternate submission is permitted in accordance with 21 CFR 814.39(e) or (f). A PMA supplement or alternate submission shall comply with applicable requirements under 21 CFR 814.39 of the final rule for Premarket Approval of Medical Devices.

All situations that require a PMA supplement cannot be briefly summarized; therefore, please consult the PMA regulation for further guidance. The guidance provided below is only for several key instances.

A PMA supplement must be submitted when unanticipated adverse effects, increases in the incidence of anticipated adverse effects, or device failures necessitate a labeling, manufacturing, or device modification.

A PMA supplement must be submitted if the device is to be modified and the modified device should be subjected to animal or laboratory or clinical testing designed to determine if the modified device remains safe and effective.

A "Special PMA Supplement - Changes Being Effectuated" is limited to the labeling, quality control and manufacturing process changes specified under 21 CFR 814.39(d)(2). It allows for the addition of, but not the replacement of previously approved, quality control specifications and test methods. These changes may be implemented before FDA approval upon acknowledgment by FDA that the submission is being processed as a "Special PMA Supplement - Changes Being Effectuated." This procedure is not applicable to changes in device design, composition, specifications, circuitry, software or energy source.

Alternate submissions permitted under 21 CFR 814.39(e) apply to changes that otherwise require approval of a PMA supplement before implementation of the change and include the use of a 30-day PMA supplement or annual postapproval report (see below). FDA must have previously indicated in an advisory opinion to the affected industry or in correspondence with the applicant that the alternate submission is permitted for the change. Before such can occur, FDA and the PMA applicant(s) involved must agree upon any needed testing protocol, test results, reporting format, information to be reported, and the alternate submission to be used.

Alternate submissions permitted under 21 CFR 814.39(f) for manufacturing process changes include the use of a 30-day Notice. The manufacturer may distribute the device 30 days after the date on which the FDA receives the 30-day Notice, unless the FDA notifies the applicant within 30 days from receipt of the notice that the notice is not adequate.

**POSTAPPROVAL REPORTS.** Continued approval of this PMA is contingent upon the submission of postapproval reports required under 21 CFR 814.84 at intervals of 1 year from the date of approval of the original PMA. Postapproval reports for supplements approved under the original PMA, if applicable, are to be included in the next and subsequent annual reports for the original PMA unless specified otherwise in the approval order for the PMA supplement. Two copies identified as "Annual Report" and bearing the applicable PMA reference number are to be submitted to the PMA Document Mail Center (HFZ-401), Center for Devices and Radiological Health, Food and Drug Administration, 9200 Corporate Blvd., Rockville, Maryland 20850. The postapproval report shall indicate the beginning and ending date of the period covered by the report and shall include the following information required by 21 CFR 814.84:

1. Identification of changes described in 21 CFR 814.39(a) and changes required to be reported to FDA under 21 CFR 814.39(b).
2. Bibliography and summary of the following information not previously submitted as part of the PMA and that is known to or reasonably should be known to the applicant:
  - a. unpublished reports of data from any clinical investigations or nonclinical laboratory studies involving the device or related devices ("related" devices include devices which are the same or substantially similar to the applicant's device); and
  - b. reports in the scientific literature concerning the device.

If, after reviewing the bibliography and summary, FDA concludes that agency review of one or more of the above reports is required, the applicant shall submit two copies of each identified report when so notified by FDA.

**ADVERSE REACTION AND DEVICE DEFECT REPORTING.** As provided by 21 CFR 814.82(a)(9), FDA has determined that in order to provide continued reasonable assurance of the safety and effectiveness of the device, the applicant shall submit 3 copies of a written report identified, as applicable, as an "Adverse Reaction Report" or "Device Defect Report" to the PMA Document Mail Center (HFZ-401), Center for Devices and Radiological Health, Food and Drug Administration, 9200 Corporate Blvd., Rockville, Maryland 20850 within 10 days after the applicant receives or has knowledge of information concerning:

1. A mix-up of the device or its labeling with another article.
2. Any adverse reaction, side effect, injury, toxicity, or sensitivity reaction that is attributable to the device and:
  - a. has not been addressed by the device's labeling; or
  - b. has been addressed by the device's labeling but is occurring with unexpected severity or frequency.

3. Any significant chemical, physical or other change or deterioration in the device, or any failure of the device to meet the specifications established in the approved PMA that could not cause or contribute to death or serious injury but are not correctable by adjustments or other maintenance procedures described in the approved labeling. The report shall include a discussion of the applicant's assessment of the change, deterioration or failure and any proposed or implemented corrective action by the applicant. When such events are correctable by adjustments or other maintenance procedures described in the approved labeling, all such events known to the applicant shall be included in the Annual Report described under "Postapproval Reports" above unless specified otherwise in the conditions of approval to this PMA. This postapproval report shall appropriately categorize these events and include the number of reported and otherwise known instances of each category during the reporting period. Additional information regarding the events discussed above shall be submitted by the applicant when determined by FDA to be necessary to provide continued reasonable assurance of the safety and effectiveness of the device for its intended use.

**REPORTING UNDER THE MEDICAL DEVICE REPORTING (MDR) REGULATION.**

The Medical Device Reporting (MDR) Regulation became effective on December 13, 1984. This regulation was replaced by the reporting requirements of the Safe Medical Devices Act of 1990 which became effective July 31, 1996 and requires that all manufacturers and importers of medical devices, including in vitro diagnostic devices, report to the FDA whenever they receive or otherwise become aware of information, from any source, that reasonably suggests that a device marketed by the manufacturer or importer:

1. May have caused or contributed to a death or serious injury; or
2. Has malfunctioned and such device or similar device marketed by the manufacturer or importer would be likely to cause or contribute to a death or serious injury if the malfunction were to recur.

The same events subject to reporting under the MDR Regulation may also be subject to the above "Adverse Reaction and Device Defect Reporting" requirements in the "Conditions of Approval" for this PMA. FDA has determined that such duplicative reporting is unnecessary. Whenever an event involving a device is subject to reporting under both the MDR Regulation and the "Conditions of Approval" for a PMA, the manufacturer shall submit the appropriate reports required by the MDR Regulation within the time frames as identified in 21 CFR 803.10(c) using FDA Form 3500A, i.e., 30 days after becoming aware of a reportable death, serious injury, or malfunction as described in 21 CFR 803.50 and 21 CFR 803.52 and 5 days after becoming aware that a reportable MDR event requires remedial action to prevent an unreasonable risk of substantial harm to the public health. The manufacturer is responsible for submitting a baseline report on FDA Form 3417 for a device when the device model is first reported under 21 CFR 803.50. This baseline report is to include the PMA reference number. Any written report and its envelope is to be specifically identified, e.g., "Manufacturer Report," "5-Day Report," "Baseline Report," etc.

Any written report is to be submitted to:

Food and Drug Administration  
Center for Devices and Radiological Health  
Medical Device Reporting  
PO Box 3002  
Rockville, Maryland 20847-3002

Copies of the MDR Regulation (FOD # 336&1336) and FDA publications entitled "An Overview of the Medical Device Reporting Regulation" (FOD # 509) and "Medical Device Reporting for Manufacturers" (FOD #987) are available on the CDRH WWW Home Page. They are also available through CDRH's Fact-On-Demand (F-O-D) at 800-899-0381. Written requests for information can be made by sending a facsimile to CDRH's Division of Small Manufacturers International and Consumer Assistance (DSMICA) at 301-443-8818.

### Summary of Safety and Effectiveness Data

#### I. GENERAL INFORMATION

Device Generic Name: Stimulator, Vagus Nerve

Device Trade Names: VNS Therapy™ System

VNS Therapy™ Pulse Model 102 Generator  
 VNS Therapy™ Pulse Duo Model 102R Generator  
 VNS Therapy™ Programming Wand Model 201  
 VNS Therapy™ Magnet Model 220  
 VNS Therapy™ Software Model 250  
 VNS Therapy™ Lead Model 302  
 VNS Therapy™ Tunneler Model 402  
 VNS Therapy™ Accessory Pack Model 502

Applicant's Name and Address: Cyberonics, Inc.  
 100 Cyberonics Boulevard  
 Cyberonics Building  
 Houston, Texas 77058

Premarket Approval Application (PMA) Number: P970003/S50

Date of Panel Recommendation: June 15, 2004

Date of Notice of Approval to the Applicant: July 15, 2005

#### II. INDICATIONS FOR USE

The VNS Therapy System is indicated for the adjunctive long-term treatment of chronic or recurrent depression for patients 18 years of age or older who are experiencing a major depressive episode and have not had an adequate response to four or more adequate antidepressant treatments.

#### III. CONTRAINDICATIONS, WARNINGS AND PRECAUTIONS

##### A. Contraindications

- The VNS Therapy System cannot be used in patients after a bilateral or left cervical vagotomy.
- Do not use shortwave diathermy, microwave diathermy or therapeutic ultrasound diathermy (hereafter referred to as diathermy) on patients implanted with a VNS Therapy System. Diagnostic ultrasound is not included in this contraindication.

Energy delivered by diathermy may be concentrated into or reflected by implanted products such as the VNS Therapy System. This concentration or reflection of energy may cause heating.

Testing indicates that diathermy can cause heating of the VNS Therapy System well above temperatures required for tissue destruction. The heating of the VNS Therapy System resulting from diathermy can cause temporary or permanent nerve or tissue or vascular damage. This

damage may result in pain or discomfort, loss of vocal cord function, or even possibly death if there is damage to blood vessels.

Because diathermy can concentrate or reflect its energy off any size-implanted object, the hazard of heating is possible when any portion of the VNS Therapy System remains implanted, including just a small portion of the Lead or electrode. Injury or damage can occur during diathermy treatment whether the VNS Therapy System is turned "ON" or "OFF".

Diathermy is further prohibited because it may also damage the VNS Therapy System components resulting in loss of therapy, requiring additional surgery for system explantation and replacement. All risks associated with surgery or loss of therapy would then be applicable.

Advise your patients to inform all their health care professionals that they should not be exposed to diathermy treatment.

#### **B. Warnings and Precautions**

See Physician Labeling

#### **IV. DEVICE DESCRIPTION**

The VNS Therapy System used for vagus nerve stimulation (VNS), consists of the implantable VNS Therapy Pulse Generator, the VNS Therapy Lead and the external programming system used to change stimulation settings. The lead and the pulse generator make up the implantable portion of the VNS Therapy System. Electrical signals are transmitted from the pulse generator to the vagus nerve by the lead. The software allows a physician to identify, read and change device settings. The pulse generator is surgically placed in the left chest. The lead is then connected to the pulse generator and attached to the left vagus nerve. Patients are provided with magnets that, by placing the magnet over the implanted pulse generator can deactivate (turn OFF) programmed stimulation. Programmed stimulation resumes when the magnet is removed.

##### **A. VNS Therapy™ Pulse Generators (Model 102 and 102R)**

The VNS Therapy™ Pulse Generators are implantable, multiprogrammable pulse generators that deliver electrical signals to the vagus nerve. Constant current, capacitively coupled, charge-balanced signals are transmitted from the Generator to the vagus nerve by the lead. The pulse generator is housed in a hermetically sealed titanium case. The pulse generator has a number of programmable settings including pulse width, magnet-activated output current, output current, magnet-activated ON time, signal frequency, magnet-activated pulse width, signal ON time and signal OFF time. The pulse generator has telemetry capability that supplies information about its operating characteristics, such as parameter settings, lead impedance and history of magnet use.

##### **B. VNS Therapy™ Lead Model 302**

The lead delivers electrical signals from the pulse generator to the vagus nerve. The lead has two helical electrodes on one end and on the other end a 3.2-millimeter (mm) connector. The lead is insulated with silicone rubber and is non-bifurcated. The lead wire is quadrifilar MP-35N, and the electrode is a platinum ribbon.



**C. VNS Therapy™ Tunneler Model 402**

The tunneler is designed for use during subcutaneous tunneling and implantation of the lead. The tunneler consists of 4 basic components: a stainless steel shaft, 2 fluorocarbon polymer sleeves and a stainless steel bullet tip. The Tunneler is supplied sterile and is for single use only.

**D. VNS Therapy™ Programming Wand Model 201**

The wand is used to activate, program, reprogram and interrogate the pulse generator.

**E. VNS Therapy™ Software Model 250**

The programming software is a computer program that permits communication with the implanted pulse generator. The programmed parameters and operational status can be interrogated. One or more parameters can be programmed at one time, and the programmed values are verified and displayed.

**F. VNS Therapy™ Accessory Pack Model 502**

The accessory pack contains replacement components for the VNS Therapy System and includes a hex screwdriver, test resistors and lead tie downs. These are supplied sterile.

**G. VNS Therapy™ Magnet Model 220**

Cyberonics provides patients two magnets—a watch-style magnet and a pager-style magnet. When a magnet is passed over the pulse generator, the magnetic field causes a reed switch within the pulse generator to close. The magnet is placed over the pulse generator to stop stimulation.

**V. ALTERNATIVE PRACTICES AND PROCEDURES**

There are currently three major treatment modalities for which there is substantial evidence of effectiveness in the treatment of a major depressive episode: pharmacotherapy with antidepressant drugs (ADDs), specific forms of psychotherapy (including cognitive behavior and interpersonal therapy), and electroconvulsive therapy (ECT). ADDs are the usual first line treatment for depression. Clinical trials have demonstrated efficacy for a number of pharmacologic classes of ADDs. Physicians usually reserve ECT for treatment-resistant cases or when they determine a rapid response to treatment is desirable.

For those patients who do not respond to initial antidepressant treatment, physicians generally use one or more of the following strategies: (1) switching to an alternative first-line ADD, (2) switching to a second-line ADD, (3) adding psychotherapy, a second ADD, or an augmentation agent. Augmentation agents are drugs that are not generally considered to have significant antidepressant activity when administered alone, but they can enhance the effectiveness of an ADD when they are administered in combination with the ADD. Augmentation agents include drugs such as lithium or atypical antipsychotic drugs. Additional options for treatment-resistant patients, especially for patients who fail on the above alternatives, include monoamine oxidase inhibitors and ECT. For treatment-resistant cases that exhibit a marked seasonal pattern, adding phototherapy to pharmacotherapy may also be an option.

**VI. MARKETING HISTORY****A. Foreign Marketing History**

Since June 1994, the VNS Therapy System has been approved as treatment for epilepsy in all countries of the European Union. In March 2001 CE Mark Approval was granted for the treatment of depression in all European Community (EC) countries. Subsequently, in April 2001 Cyberonics began distribution of the VNS System for the treatment of depression in Canada. The VNS Therapy System has not been withdrawn from marketing in any country outside the United States for any reason, including those related to the safety or effectiveness.

**B. U.S. Marketing History**

Since July 1997 the VNS Therapy System has been approved for use as an adjunctive therapy in reducing the frequency of seizures in adults and adolescents over 12 years of age with medically refractory partial onset seizures. The VNS Therapy System has not been withdrawn from marketing in the U.S. for any reason related to the safety or effectiveness.

**VII. POTENTIAL ADVERSE EFFECTS OF THE DEVICE ON HEALTH**

In addition to the normal risks associated with a surgical procedure, complications associated with implantation include, but may not be limited to, vagus nerve damage; skin irritation; pain at the incision site; infection; extrusion or migration of the pulse generator and/or lead dislodgment, disconnection (from pulse generator), breakage (lead), or corrosion; hematoma; fluid accumulation; cyst formation; inflammation; and histotoxic reactions. These phenomena may require device replacement to correct the complication. A pivotal clinical trial of 235 subjects (D-02) was conducted by the sponsor to evaluate the safety and effectiveness of the device for the intended use. The number (and percentage) of subjects reporting an event during the 0-3 month period and during the 9-12 month period is depicted in Table 1 below.

**Table 1 – Adverse Events Associated With VNS Therapy at 0-3 Months and 9-12 Months**

<b>Adverse Event</b>	<b>0-3 Months (N=232)</b>	<b>9-12 Months (N=209)</b>
Voice Alteration	135 (58.2%)	113 (54.1%)
Increased Cough	55 (23.7%)	13 (6.2%)
Neck Pain	38 (16.4%)	27 (12.9%)
Dyspnea	33 (14.2%)	34 (16.3%)
Dysphagia	31 (13.4%)	9 (4.3%)
Paresthesia	26 (11.2%)	9 (4.3%)
Laryngismus	23 (9.9%)	10 (4.8%)
Pharyngitis	14 (6.0%)	11 (5.3%)
Nausea	13 (5.6%)	4 (1.9%)
Pain	13 (5.6%)	13 (6.2%)
Headache	12 (5.2%)	8 (3.8%)
Insomnia	10 (4.3%)	2 (1.0%)
Palpitation	9 (3.9%)	6 (2.9%)
Chest Pain	9 (3.9%)	4 (1.9%)
Dyspepsia	8 (3.4%)	4 (1.9%)
Hypertonia	6 (2.6%)	10 (4.8%)
Hypesthesia	6 (2.6%)	2 (1.0%)
Anxiety	5 (2.2%)	6 (2.9%)
Ear Pain	5 (2.2%)	6 (2.9%)
Eructation	4 (1.7%)	0
Diarrhea	4 (1.7%)	2 (1.0%)
Dizziness	4 (1.7%)	3 (1.4%)
Incision Site Reaction	4 (1.7%)	2 (1.0%)
Asthma	4 (1.7%)	3 (1.4%)
Device Site Reaction	4 (1.7%)	0
Device Site Pain	4 (1.7%)	2 (1.0%)
Migraine Headache	4 (1.7%)	2 (1.0%)

## VIII. PRE-CLINICAL STUDIES

### A. Summary of Non-Clinical Laboratory Studies

#### 1. Pre-Clinical Laboratory and Animal Studies

A summary of these studies can be found in the Summary of Safety and Effectiveness document for P970003 (epilepsy indication). No additional pre-clinical or animal studies were required for this application.

#### 2. Risk Analysis

The commercially available system's risk analysis was re-evaluated for treatment-resistant depression (TRD). Since subjects undergo the same implantation procedure using the same system, no new surgical risks were identified. The sponsor evaluated the potential risks associated with patients who are implanted and are having a TRD episode. The risks associated with this population include suicide attempt/suicide, manic depressive reaction, anxiety, confusion, overdose, and worsening depression. No design related mitigation solutions could be developed.

## IX. SUMMARY OF CLINICAL INVESTIGATIONS

Cyberonics has conducted the following studies to support the use of the VNS System in subjects with treatment-resistant depression:

- a feasibility trial (D-01);
- a randomized, sham-controlled 3-month clinical trial (D-02, acute)
- a long-term (12-and 24-month) open-label extension (D-02, long-term); and
- a long-term (12-month) observational study of subjects receiving standard-of-care treatments (D-04) for comparison to D-02 long-term.

### 1. Feasibility Study D-01

D-01 was an open-label, nonrandomized, single arm, multicenter, 60-patient study of VNS in treatment-resistant major depression. The study included an acute 12-week phase as well as a subsequent long-term follow-up. Patients were required to maintain a stable antidepressant medication regimen during the acute phase of the study.

The most commonly reported treatment-emergent adverse events, regardless of relationship to stimulation (in order of frequency) were: voice alteration (75%), neck pain (32%), depression (27%), headache (27%), dyspnea (23%), dysphagia (18%), increased cough (17%), nausea (15%), dyspepsia (12%), and dizziness (10%). Seventy-seven (77) events in 38 subjects were rated as serious (10 in acute phase and 67 in long-term follow-up) including 34 reports of worsening depression and 12 suicide attempts or overdose.

Fifty-nine of the 60 subjects completed the 12-week acute phase and were available for evaluation of effectiveness. Primary efficacy analysis of the 28-item Hamilton Rating Scale for Depression (HRSD<sub>28</sub>) at the end of this phase showed 18 (31%) of the 59 evaluable subjects met response criteria ( $\geq 50\%$  reduction in score as compared to baseline). In addition, 25 of 55 (45%) were responders after one year, and 18 of 42 (43%) after two years. Furthermore, after one year of stimulation, 13 of the 18 acute responders (72%) maintained their response and 12 of the acute non-responders (29%) became responders. Of the subjects included in the evaluable population, 15%, 27% and 21% reached remission (HRSD<sub>28</sub>  $\leq 10$ ) at 12 weeks, 1 year, and 2 years, respectively.

### 2. Pivotal D-02 Study and D-02/D-04 Comparison Study

The acute phase of D-02 was a 12-week, double-blind, randomized, sham treatment-controlled, multi-center, pivotal study where subjects were implanted with the VNS System and randomized to either the treatment (stimulation) group or control (sham) group. Two weeks after surgery, treatment group subjects had the device turned ON and the output current adjusted to a tolerable level during a 2-week period. Sham subjects were treated identically; however, the output current of the device was set at 0.00 mA throughout the acute phase. The treatment group subjects' stimulation parameters remained constant for the remainder of the acute study (8 weeks) but were permitted to be decreased to accommodate for events possibly related to tolerance. During the acute phase of the study, antidepressant medications were to remain unchanged from baseline.

After completion of the 12-week acute phase, subjects could continue in an open-label long-term phase (D-02, long-term), during which time subjects in the treatment group continued VNS therapy and stimulation was initiated for subjects originally in the sham-control group. Sham subjects followed the same treatment schedule that the treatment group received during the acute

phase. Following the acute phase, changes in concomitant treatments (medications and ECT) were permitted.

D-04 was a long-term, observational, prospective study designed to collect data regarding usual standard-of-care (SOC) treatment for TRD in people who were in a major depressive episode at the time of admission. The usual SOC was defined as the treatment strategy the physician and subject chose to follow. Clinical depression assessments and quality of life outcomes were assessed at baseline, 3, 6, 9 and 12 months. D-04 was intended to provide a comparison group for the D-02 long-term analysis. *Safety data were not prospectively collected in D-04.*

**a) Inclusion/Exclusion Criteria**

D-02 and D-04 Inclusion criteria

- Age 18-80
- In a chronic ( $\geq 2$  years) current major depressive episode (MDE) and/or have had a history of recurrent MDEs ( $> 4$  lifetime episodes, including current) per DSM-IV.
- HRSD<sub>24</sub> score  $\geq 20$  at the acute phase baseline.
- Failed 2-6 mood disorder treatments from different treatment categories as determined by an Antidepressant Resistance Rating (ARR) score of 3 or higher using the modified version of the Antidepressant Treatment History Form)
- Continuation criteria required an HRSD<sub>24</sub> score  $\geq 18$ .
- History of treatment with psychotherapy  $> 6$  weeks without improvement (D02 only)
- Stable medication regimen of not more than 5 medications for at least 4 weeks prior to the baseline visit (D02 only)
- Adequate contraception (D02 only).

Exclusions for both studies included:

- Atypical depression or psychotic symptoms;
- Schizophrenia, schizoaffective disorder, or delusional disorders;
- Rapid cycling; delirium, dementia, amnesic, or other cognitive disorders;
- Not having an acceptable clinical response due to failure with  $\geq 7$  antidepressant treatments during the current MDE;
- Recent suicide attempts (or suicide risk/plan) within 12 months;
- Recent alcohol or substance dependence or abuse (other than nicotine);
- Other progressive neurological disease, significant CNS disease or injury;
- Current enrollment in another investigational study or using an investigational device;
- History of, or evidence of, significant brain malformation or significant head injury, clinically apparent cerebral vascular events, prior brain surgery such as cingulotomy; or previous implantation with the VNS.
- Myocardial infarction or arrest, general anesthesia within 30 days, ASA III or IV, pacemaker or other implantable stimulator, likely to require MRI or diathermy (D-02 only)

**b) Concomitant Mood Disorder Treatments**

D-04 subjects were allowed to have mood disorder treatments changed according to the investigator and subject's determination of the best treatment regimen. For the D-02 study, continuation of stable baseline mood disorder treatments was allowed. *Changes* to these treatments were not allowed during the 12-week acute phase but were allowed during the long-term phase, although such changes were discouraged.

c) **D02 and D04 Study Accountability and Subject Population**

D02 Subject Accountability

Of the 235 subjects who were enrolled and randomized in the Acute D-02 study, 2 subjects withdrew during the acute phase (including 1 suicide), 2 additional subjects did not complete the acute study, and 9 were either protocol violations or failed to meet Visit 2 continuation criteria. Therefore, at the end of the acute phase of the D-02 study, 222 subjects were evaluable for effectiveness with 112 from the treatment group and 110 from the sham-control group.

A total of 233 subjects entered the long-term phase of D-02. During this phase, 28 subjects were deemed to be not evaluable for effectiveness for the following reasons:

- No effectiveness data included at any long-term visit 4
- Did not meet acute phase continuation criteria 3
- Did not have acute exit HRSD score  $\geq 18$  if in sham group 21

A total of 205 subjects were therefore *evaluable* for effectiveness at the end of the D-02 long-term phase study (110 from the original treatment group and 95 from the original sham group) and 209 were evaluable for safety. Of these, 28 did not complete 12 months of follow-up for the following reasons:

- Withdrew before 1 year of stimulation 17
- Reached 1 year but device was ON < 80% of time 6
- Did not have 1 year assessments/records 5

The most common reason cited for early withdrawal was lack of effectiveness. In the end 177 *12-month stimulation completers* (103 from the original stimulation group and 74 from the original sham group) contributed to the effectiveness analysis for the long-term D-02 and D-02/D-04 comparison.

D04 Subject Accountability

For the D04 study, 138 subjects were enrolled. Of these, 11 discontinued and 3 only provided baseline data. As such, 124 subjects were included in the *evaluable* population for this portion of the study. Of these 124, 112 were 12-month *completers* which provided effectiveness data.

D02 and D04 Subject Demographics

Table 2 lists baseline demographics of the evaluable D-02 and D-04 subjects.

**Table 2. D02, D04 Comparison of Demographics (Evaluable Subjects)**

Parameter	Statistic	D02 (N=205)	D04 (N=124)
Age (years)	Mean	46.3	45.5
Male	N (%)	74(36)	39(31)
Female	N (%)	131(64)	85(69)
Caucasian	N (%)	198(97)	111(90)*
African-American	N (%)	3(1)	5(4)
Hispanic	N (%)	3(1)	2(2)
Unipolar	N (%)	185(90)	109(88)
Bipolar	N (%)	20(10)	15(12)
Recurrent	N (%)	161(87)	93(85)
Single Episode	N (%)	24(13)	16(15)
Length of Current MDE (mos)	Mean (S.D.)	49.9(52.1)	68.6(91.5)
# Failed Trials in Current MDE	Mean (S.D.)	3.5(1.3)	3.5(1.3)
Received ECT Lifetime	N(%)	108(53%)	32(26%)*
Received ECT, Current MDE	N(%)	72(35%)	15(12%)*
Duration of Illness (yrs)	Mean (S.D.)	25.5(11.9)	25.8(13.2)
Lifetime episodes of Depression			*
0-2	N(%)	50(24)	31(25)
3-5	N(%)	69(34)	36(29)
6-10	N(%)	56(27)	18(15)
>10	N(%)	19(9)	32(26)
No Suicide Attempts in Lifetime	N(%)	140(68)	80(65)
Treatment induced (hypo)mania	N(%)	16(8)	6(5)
Hospitalizations for Depression	Mean (S.D.)	2.7(5.4)	2.1(2.9)
ECT Treatment Within past 2yrs	N(%)	54(26)	19(15)

\* p&lt;0.05.

**d) Safety Data****Acute Phase Adverse Events****Implantation-Related**

Some acute phase adverse events were noted and judged to be implant-related (due to the surgery). These included the following events (based on N=235): Incision Pain, 84 (36%); Voice Alteration, 78 (33%); Incision Site Reaction 67 (29%); Device Site Pain, 54 (23%); Device Site Reaction, 33 (14%); Pharyngitis, 31 (13%); Dysphagia 26 (11%); Hypesthesia, 25 (11%); Nausea, 20 (9%); Dyspnea, 20 (9%); Neck Pain, 16 (7%); and Increased Cough, 15 (6%).

**Stimulation-Related (Device-Related)**

Table 3 reports adverse events during the acute randomized phase of D-02 which occurred in the active stimulation group at rates  $\geq 3\%$  and were judged at least possibly related to stimulation.

**Table 3. Incidence of Treatment-Emergent Adverse Events  $\geq$  3% in Acute Phase of D-02**

Event	Treatment (N=119) N (%)	Sham- control (N=116) N (%)
Voice alteration	65 (55%)	3 (3%)
Cough increased	28 (24%)	2 (2%)
Dyspnea	23 (19%)	2 (2%)
Neck pain	19 (16%)	1 (<1%)
Dysphagia	15 (13%)	0
Laryngismus	13 (11%)	0
Paresthesia	12 (10%)	3 (3%)
Pharyngitis	9 (8%)	1 (<1%)
Nausea	8 (7%)	1 (<1%)
Incision Pain	6 (5%)	3 (3%)
Headache	5 (4%)	1 (<1%)
Insomnia	4 (3%)	0
Dyspepsia	4 (3%)	0
Diarhea	3 (3%)	0
Palpitations	3 (3%)	1 (<1%)
Dizziness	3 (3%)	0
Chest Pain	3 (3%)	1 (<1%)

**Duration of Early Adverse Events**

For the 7 events which occurred at a frequency  $\geq$  10% in the VNS Therapy group during the acute randomized phase of the study (Table 3), further analysis was performed to determine how long these events persisted in subjects. Table 4 shows a cohort of subjects who reported the 7 most common adverse events during their first 3 months of stimulation and who also had follow-up visits during months 9 through 12. Numbers in the last 3 columns refer to the number (and percentage) of subjects who had the event between months 0-3 (second column) who continued to have the symptom at the latter point.



**Table 4. Persistence of Early Stimulation-Related Events Through One Year (N=209)**

Preferred Term	N Reporting Event During First 3 Mos. <sup>1</sup>	N (%) <b>Continuing to Report Event During Succeeding Quarters</b> <sup>2</sup>			
	0-3 Mos.	3-6 Mos.	6-9 Mos.	9-12 Mos.	
Voice Alteration	135	115 (85%)	101 (75%)	90 (67%)	
Cough Increased	55	18 (33%)	15 (27%)	11 (20%)	
Neck Pain	38	17(45%)	19 (50%)	16 (42%)	
Dyspnea	35	22 (63%)	18 (51%)	16 (46%)	
Dysphagia	31	16 (52%)	10 (32%)	6 (19%)	
Paresthesia	26	12 (46%)	6 (23%)	4 (15%)	
Laryngismus	23	13 (57%)	9 (39%)	5 (22%)	

<sup>1</sup>Entries are the number of subjects who experienced the AEs between implantation and 3 months.

<sup>2</sup>Number of subjects who continued to experience the same adverse event between months 3 and 6, months 6 and 9, and months 9 and 12.

Note: Subjects were counted only once within each preferred term and time interval.

#### Late-Emerging Adverse Events

New adverse events first reported after the first 3 months of stimulation were assessed by the sponsor. Only event types which were *not* reported by any subjects during the first 3 months were included in this data set. Hence, new reports of voice alteration, neck pain, and the like were not included in this analysis. The new events included syncope (3), gastritis (3), weight gain (3), deafness (2), colitis (2), and 1 of each of the following: stridor, hypotension, speech disorder, back pain, weight loss, arthralgia, myalgia, amblyopia, and viral or flu infection.

#### Serious Adverse Events (SAE)

A serious adverse event was defined as one that resulted in death, was life-threatening, resulted in or prolonged hospitalization, resulted in a persistent disability, or involved a congenital anomaly. All events were reported regardless of relationship to VNS Therapy.

#### SAE During Acute Phase of D-02

In the acute D-02 study, there were 30 SAEs in 27 subjects. One death due to suicide occurred in an active stimulation subject. The following SAE occurred more than once.

- Worsening Depression            12 events in 11 subjects (5 treatment, 7 control subjects)
- Site Reaction                        2 events in 2 subjects (2 treatment subjects)
- Pneumonia                            2 events in 2 subjects (1 treatment, 1 control subject)
- Dehydration                         2 events in 2 subjects (1 treatment, 1 control subject)

In addition, the following were reported once in the treatment group alone: asystole, bradycardia, confusion, abnormal thinking, wound infection, and urinary retention. The following SAE were reported once in the control group alone: renal failure, vocal cord paralysis, cholecystitis, voice alteration, and myasthenia.

#### SAE in the Long-Term Phase of D-02

In the D-02 long-term phase there were 96 SAE. These events are shown in Table 5 below.

Table 5 – Serious Adverse Events in Long-Term D-02

Event	# of Events	# Subjects
Worsening Depression	62	31
Suicide Attempt	7	6
Syncope	4	3
Convulsion	2	2
GI Disorder	2	2
Sudden Unexplained Death	1	1
Chest Pain, Abdominal Pain, Peritonitis, Cholecystitis, Constipation, Dehydration, Dizziness, Drug Dependence, Manic Depression, Somnolence, Abnormal Thinking, Overdose, Accidental Injury, Breast CA, Wound Infection, Surgical Procedure, Enlarged Uterine Fibroid, Cholelithiasis	1 each (18)	18

**Deaths**

Four deaths were reported. One occurred prior to implantation/stimulation. Two deaths occurred after device implantation and prior to the 12 month follow-up. One was a suicide during the acute phase (in the treatment group) and one was listed as “undetermined” cause. The latter occurred approximately 2-3 months after implantation and stimulation. An additional death occurred after 12 months of follow-up and was due to acute brain injury.

**Specific Depression-Related Adverse Events****Mania/Hypomania**

The Young Mania Rating Scale (YMRS) was used to detect the emergence of mania in the D-02 study. Three (3) subjects had a manic reaction reported. Another 3 had YMRS > 15 during the long-term phase without an adverse event being reported. Two of the six patients had their event during the acute phase and 5 of the 6 had a prior history of bipolar disorder or mania. One subject’s mania was classified as a serious adverse event.

**Worsening Depression**

In the acute phase there were 12 reports of worsening depression, 5 in the stimulation group [4 of 119 subjects] and 7 in the sham group [7 of 116 subjects]. One of the treatment-group reports occurred prior to stimulation initiation. Following acute phase exit and during the 12-month period of stimulation, 62 events were reported in 31 subjects. The number of episodes or worsening depression per patient ranged from 1 to 6. Of note, rates of worsening depression (and other safety endpoints) were not collected during the D04 study for direct comparison. However, the item of “hospitalizations for psychiatric illness” which might be used as a surrogate for worsening depression was captured in D04. The rate of such was 0.237 events per patient-year in the D04 group (n=124 subjects) compared to 0.284 in the 1-year D02 group (n=233 subjects) and 0.314 in the D-02 sham group (n=116 subjects).

**Suicidal Ideation and Suicide.**

One way in which the sponsor analyzed change in suicidal ideation was to look at Item 3 of the HRSD<sub>24</sub> score. During the acute D-02 study, 2.6% of sham subjects and 1.7% of the stimulation subjects increased their Item 3 score by 2 or more points. During the long-term D-02 phase, 2.8% of subjects had increased their Item 3 score by at least 2 points at 12 months versus baseline. In

the D-04 group, this was 1.9%. Conversely, 27% of D-02 subjects decreased their score by at least 2 points at 12 months compared to baseline whereas only 9% of D-04 subjects did.

As noted above, 1 subject committed suicide in the acute phase and 6 attempted suicide during the 12 months of the long-term stimulation phase of D-02 (n=235). One of the 6 subjects noted in the long-term phase attempted suicide twice. Although safety data were not formally collected for the D-04 study, the health care utilization form documented suicide attempts. There were 3 suicide attempts in this group through the first year (n=124).

#### e) Effectiveness Data

##### D02 Acute Study

The primary effectiveness endpoint for the randomized, sham-controlled study was an analysis of the percent responders ( $\geq 50\%$  decrease in HAM-D (Hamilton) score from baseline to exit) between the 2 groups. In an evaluable patient population, 15.3% (17/111) of the active stimulation group were considered responders as compared to 10.0% of the sham group (11/110). This difference was *not* statistically significant (p=0.238).

Secondary endpoints of the acute phase study assessed changes in other depression scales (IDS-SR, CGI, MADRS, SF-36). The IDS-SR scale revealed a significant difference in the percent responders (17.4% versus 7.5%, p=0.032). None of the other scales (CGI, MADRS, YMRS, SF-36) identified as secondary endpoints, however, showed a statistically significant difference.

After completing the analysis of this acute phase data, an alternate statistical plan for demonstrating effectiveness was employed that included comparison of 12 month results of the D-02 continuation phase to the results of the D-04 observation study (see below).

##### D02 Long-Term Phase

The primary endpoint for the evaluation of the long-term phase of D-02 was a repeated measures linear regression analysis performed on the raw HAM-D (HRSD<sub>24</sub>) scores during the first 12 months after initiation of stimulation on the 12 month completer population. This was calculated as the average of the slopes across the 4 quarters with each quarter having equal weight. As a secondary endpoint, similar data was assessed using the IDS-SR scale. These results are shown in Table 6.

**Table 6. D-02 Long-Term Primary Effectiveness Results**

	N	Slope	p-value
12-Month Completer Population	177		
HAM-D		-0.47/month	<0.001
IDS-SR		-0.55/month	<0.001
12-Month Evaluable Population	205		
HAM-D		-0.45/month	<0.001
IDS-SR		-0.52/month	<0.001
12-Month Intent-to-Treat Population	231		
HAM-D		-0.40/month	<0.001
IDS-SR		-0.45/month	<0.001

Patients were also assessed in terms of response rates as a secondary endpoint. Again, response was defined as a 50% of more improvement in a scale's score at 12 months compared with

baseline. Complete response (or remission) was defined as a score  $\leq 9$  for HAM-D and  $\leq 14$  for IDS-SR. These results at 12 months are shown below in Table 7.

**Table 7. 12-Month Evaluable Responder and Remission Rates**

	Response	Remission
HAM-D	29.8%	17.1%
IDS-SR	21.7%	15.0%

### Sustained Response

The evaluable population was assessed over the last 4 visits of the first year (months 9, 10, 11, and 12) to ascertain which subjects were “sustained responders” (defined as  $\geq 1$  visit with  $\geq 50\%$  response and at least an additional 2 visits with  $\geq 40\%$  response). Using this definition, 27% (47/177) of the 12-month completer population were considered sustained responders.

To explore whether subjects were receiving benefit that was not fully reflected in these response rates, subjects were assigned to “clinical benefit” categories prospectively defined as extraordinary benefit ( $\geq 75\%$  improvement in HRSD<sub>24</sub>), highly meaningful benefit (50-74%), meaningful benefit (25% -49%), minimal/no benefit (0%-24%), and worsened ( $<0\%$ ). At 12 months, the percentage of evaluable subjects (n=180) in each of these categories was as follows:

- Extraordinary Benefit 10.6%
- Highly Meaningful Benefit 20.0%
- Meaningful Benefit 25.0%
- Minimal or No Benefit 26.7%
- Worse 17.8%

As can be seen after 12 months, 56% of *evaluable* D-02 patients were realizing at least a meaningful clinical benefit. This includes 57 (out of 122) subjects who were originally rated as minimal to worse at 3 months.

For the long-term D-02 subjects who were considered HRSD responders after 12 months of stimulation, data depicting scores over time were further analyzed. Table 8 below describes some long-term response characteristics of these subjects who were regarded as “responders”.

**Table 8 – HRSD Responder Characteristics**

	Number of Subjects	% of Responders (N=54)
Had $\geq$ 50% of all assessments as responder	31	57.4%
Had $\geq$ 75% of all assessments as responder	9	16.7%
Had last 2 consecutive months as responder	34	63.0%
Had last 3 consecutive months as responder	24	44.4%
Able to reduce/eliminate antidepressant medications	7	13.0%

**Response by Diagnosis**

Separate analyses for both unipolar and bipolar groups were performed and found to show identical results for the evaluable, ITT, or 12 month completer populations. Most of the unipolar analyses retained statistical significance although the bipolar group sample size was too small for most of the outcomes to reach statistical significance.

**D02/D04 Comparisons**

The efficacy analysis for the D02-D04 comparative analysis was the comparison of the change over time (slope) of the IDS-SR raw scores across 12-months with a repeated measures linear regression model. A statistically significant difference ( $p < 0.001$ ) was demonstrated in the estimated IDS-SR raw scores per month between the D02 and D04 evaluable populations (-0.397 estimated average difference per month). The outcome result is presented graphically in Figure 2 below.

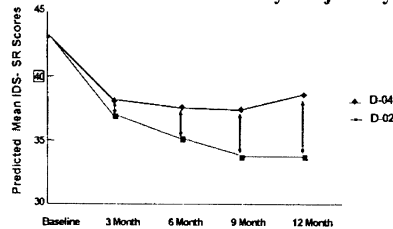
**Figure 2. IDS-SR Scores D-02 Versus D-04 Study Subjects by Quarter**

	B/L	3 mos	6 mos	9 mos	12 mos
Mean D-04 Scores (N=124)	43.0	38.1 (N=120)	37.5 (N=119)	37.3 (N=116)	38.5 (N=112)
Mean D-02 Scores (N=201)	43.0	36.9 (N=200)	35.1 (N=195)	33.7 (N=183)	33.7 (N=177)

When the analysis was repeated on the populations representing all implanted D-02 subjects compared to all D-04 subjects having any data (D-02 N = 235; D-04 N = 127), the results remained statistically significant ( $p < 0.001$ ).

Baseline demographic and illness characteristic differences were controlled in the repeated measures linear regression analysis by incorporating the 5-level grouped propensity score. This 5-level grouped propensity score did not contribute to the statistical significance of the outcome

( $p = 0.831$ ). Based on this analysis, the observed baseline demographic and illness characteristics did not contribute to the difference in outcome between the D-02 and D-04 populations.

**Secondary Analyses (D-02 vs D-04 Comparison)**  
**IDS-SR and HRSD<sub>24</sub> 12-Month Results**

Tables 9 and 10 below show results of IDS-SR and HRSD<sub>24</sub> evaluations at 12 months for both the D-02 and D-04 long-term evaluable populations.

**Table 9. IDS-SR Scores – D-02/D-04 Evaluable Observed Populations**

	D-02	D-04	P-Value
N	180	112	
Baseline Average Raw Score (RS)	42.4	43.8	
<b>12 Month Data</b>			
Average RS	32.6	39.2	
Median RS	32	40	
Average Change	-9.8	-4.6	<0.001
LOCF Average Change	-9.3 (N=204)	-5.0 (N=124)	<0.001
Median Change	-8.5	-3.5	
Avg. % Change	23.4	8.1	
Median % Change	20.6	7.9	
Response (% of Subjects)	22	12	0.029
LOCF Response (% of Subjects)	20 (N=204)	12 (N=124)	0.108
Complete Response (% Subjects)	15	4	0.006
LOCF Complete Response (%)	13 (N=204)	3 (N=124)	0.007

**Table 10. HRSD<sub>24</sub> Scores – D-02/D-04 Comparisons Evaluable Observed Populations**

	D-02	D-04	P-Value
N	180	104 <sup>1</sup>	
Baseline Average	27.9	27.8	
<b>12 Month Data</b>			
Average	19.6	22.8	
Median	19.5	23.5	
Average Change	-8.2	-4.9	0.006
LOCF Average Change	-7.4 (N=205)	-4.9 (N=104)	0.040
Median Change	-7.5	-5.0	
Avg. % Change	29.6	16.6	
Median % Change	28.4	15.6	
Response (% of Subjects)	30	13	0.003
LOCF Response (% of Subjects)	27 (N=205)	13 (N=104)	0.011
Complete Response (% Subjects)	17	7	0.031
LOCF Complete Response (%)	16 (N=205)	7 (N=104)	0.059

<sup>1</sup> – 20 D-04 subjects did not have HRSD's performed at their 12-month visit; the 12-month HRSD was added after study initiation and several sites did not have IRB approval prior to subjects reaching one-year in the study.

**Censored Analysis (D-02 versus D-04 Comparison)****IDS-SR and HRSD<sub>24</sub> 12-Month Results after Censoring for Concomitant Treatments**

Medication changes and ECT treatments were permitted in D02 subjects following the 12-week acute phase portion of the study. A total of 14 D-02 subjects received ECT during the long-term phase. ECT was used more frequently in non-responders. Four of the 14 subjects were responders, two of which were complete responders; none of the subjects were sustained responders (HRSD<sub>24</sub>). Only one responder received ECT in proximity to the 12-month visit. Seven (7) D-04 subjects received ECT through 12-months. Two of these 7 were responders at 12-months. To ascertain mood medication changes over the course of the long-term phase, an antidepressant resistance rating (ARR) score was determined for each medication for each subject. More D-02 non-responders (77%) and D-04 subjects (81%) than D-02 responders (56%) added or increased mood medications during the 12 months of VNS Therapy.

An additional post-hoc analysis was performed comparing D02 and D04 subjects after censoring the D02 patients at the first time of a significant addition or change in antidepressant treatment and using the IDS score obtained just prior to this change for all subsequent visits. With this analysis, the difference observed in the estimated IDS-SR raw scores per month between D02 and D04 evaluable populations at 12 months was -0.183 which was not statistically significant ( $p=0.052$ ). In addition, the response rate for the HSRD endpoint decreased from 30% to 19.9%. This censored rate for HSRD was not statistically different from the D04 group response rate (13%,  $p=0.118$ ). Differences in response rates using the IDS-SR scale also were not significant after censoring (18% versus 12%,  $p=0.085$ ).

**Sustained Response at 12 Months**

As IDS-SR scores were collected only quarterly in the D-04 group, sustained response for comparison of the two groups was defined as a 50% improvement or better at the last two measured quarters (IDS-SR at 9- and 12-months compared to baseline). Statistically significantly more evaluable D-02 subjects (13%) had sustained response than D-04 subjects (4%) [ $p = 0.005$ ] using this definition.

**CGI-I (Clinical Global Impression – Improvement)**

Thirty-seven percent (37%) of evaluable D-02 subjects were rated as much improved or very much improved at 12 months compared to D-04 subjects (12%;  $p < 0.001$ ).

**Other Statistical Analyses of D-02/D-04 Data**

An intent-to-treat (ITT) analysis included 231 D-02 subjects and 124 D-04 subjects. The ITT analysis results of the efficacy model were statistically significant ( $p < 0.001$ ). An LOCF analysis uses the last available observation for subsequent time points where data are missing. LOCF analyses were performed on all D-02/D-04 secondary comparisons, and statistical significance was maintained for all comparisons except for the IDS-SR evaluable response rates and HRSD<sub>24</sub> evaluable complete response rates; in these latter two analyses, the results were not statistically significant ( $p=0.108$  and  $0.059$  respectively).

Since the D-02 and D-04 studies had some different sites the results were examined from sites that were only involved in both the D-02 and D-04 studies. This examination (using the HRSD<sub>24</sub>) yielded results similar to the analysis that included all sites (27% HRSD<sub>24</sub> 12-month responder rate for D-02 sites that also participated in D-04 vs. 30% for all D-02 sites). A formal statistical analysis was not performed because the decreased sample size would not ensure adequate power.

**SUPPLEMENTAL DATA**

Although not provided in the original PMA, the sponsor submitted additional information to FDA in a PMA Supplement following the Advisory Panel Meeting. This information is summarized below.

**2-Year Response Rates**

The sponsor provided 2-year HRSD effectiveness data on 199 subjects including 42 from D-01 (feasibility) and 157 from D-02 (pivotal) representing 75% of the evaluable subjects and 67% of the implanted patients combined from both studies. Table 11 below shows HRSD response and complete response rates at 24 months as well as 3 and 12 months for evaluable subjects.

**Table 11. Evaluable D-01 and D-02 HRSD Response Rates 3-24 Months**

	<b>D-02</b>	<b>D-01</b>	<b>Combined</b>
<b>3 Months</b>	N=205	N=59	N=264
Responder	30 (14.6%)	18 (31%)	48 (18.2%)
Complete Responder	15 (7.3%)	9 (15%)	24 (9.1%)
<b>12 Months</b>	N=181	N=55	N=236
Responder	54 (29.8%)	25 (45%)	79 (33.5%)
Complete Responder	31 (17.1%)	15 (27%)	46 (19.5%)
<b>24 Months</b>	N=157	N=42	N=199
<b>Responder</b>	<b>51 (32.5%)</b>	<b>18 (43%)</b>	<b>69 (34.7%)</b>
<b>Complete Responder</b>	<b>27 (17.2%)</b>	<b>9 (21%)</b>	<b>36 (18.1%)</b>

The sponsor further evaluated D-02 subjects at 2 years in terms of “clinical benefit” categories based on changes in HRSD scores. This information is included in Table 12 below.

**Table 12 – “Clinical Benefit” at 3, 12 and 24 Months for Evaluable D-02 Subjects**

	<b>3 Months (N=205)</b>	<b>12 Months (N=180)</b>	<b>24 Months (N=157)</b>
< 25% Improvement (Minimal Benefit)	142 (70%)	80 (44%)	69 (43%)
25-49% Improvement (Meaningful Benefit)	33 (16%)	45 (25%)	36 (23%)
50-74% Improvement (Highly Meaningful Benefit)	21 (10%)	36 (20%)	37 (24%)
>75% Improvement (Extraordinarily Meaningful Benefit)	9 (4%)	19 (11%)	15 (10%)

As can be seen in the table above, at 24 months, 57% of evaluable subjects received at least meaningful benefit and 34% received at least a highly meaningful benefit. In an ITT analysis, however, these percentages are 38% and 23% respectively.

It should be noted that changes and additions in concomitant medications and ECT were allowed from 3 months through this 24 month follow-up and the impact of these changes is unknown.

**2-Year Sustained Response**

An analysis was also performed to evaluate “2-year sustained response.” Sustained response was defined as having an initial  $\geq 50\%$  reduction in HRSD score at the designated “early” visit (3 months or 12 months) and then maintaining at least a  $\geq 40\%$  reduction at the later visit (1 or 2 years, respectively). Of the 30 subjects who were 3-month responders, 18 (60%) maintained



responder status at 12 months and 21 (70%) maintained responder status at 24 months. Of the 54 12-month responders, 37 (69%) were also responders at 24 months. Similar rates are seen with IDS data (61%, 57%, and 85% respectively).

#### **New Analysis of Medication Changes**

The sponsor performed an additional analysis on antidepressant medications in D-02 subjects. For this analysis, evaluable subjects with an increase in antidepressant medication were compared to subjects who had no increase in antidepressant medication. A total of 48 evaluable subjects had no increase in antidepressant medication while 157 did have an increase over one year of VNS therapy. At 12 months, 50% of the subjects without increase in medications were responders as compared to 23% of the subjects who did have an increase in medications.

#### **2-Year Therapy Continuation Rates**

At one year, 98% (59/60) of D-01 subjects and 90% (211/235) of D-02 subjects continued to receive VNS therapy. At 2 years, 87% (52/60) of D-01 subjects and 81% (190/235) of D-02 subjects continued with VNS therapy.

#### **Adverse Event Update**

Five (5) new events judged to be related to stimulation were noted between 12 and 24 months that were not reported in the time prior: back pain, cerebral ischemia, hyperventilation, sinusitis, and urinary frequency. The rates of the most common non-serious adverse events after 18 and 24 months of follow-up are shown in Table 13 below.

**Table 13. Most Common Adverse Events at 18 and 24 Months**

<b>Event</b>	<b>18 Months (N=200)</b>	<b>24 Months (N=184)</b>
Voice Alteration	100 (50%)	95 (51.6%)
Neck Pain	27 (13.5%)	28 (15.2%)
Dyspnea	28 (14.0%)	25 (13.6%)
Laryngismus	9 (4.5%)	10 (5.4%)
Pain	15 (7.5%)	10 (5.4%)
Dysphagia	6 (3.0%)	9 (4.9%)
Increased Cough	14 (7.0%)	8 (4.3%)
Pharyngitis	9 (4.5%)	8 (4.3%)
Paresthesia	6 (3.0%)	7 (3.8%)

No reports of mania were recorded between 12 and 24 months of stimulation.

#### **Serious Adverse Events**

Table 14 below depicts the updated number of events of worsening depression and suicide attempts by the quarter in which the event was reported known to the sponsor as of 10/10/03.

Table 14. Worsening Depression and Suicide Attempts per Quarter of Stimulation

Quarter after Start of Stimulation		Number of Events of Worsening Depression	Number of Suicide Attempts
Year 1	1 <sup>st</sup>	13	2
	2 <sup>nd</sup>	19	3
	3 <sup>rd</sup>	13	2
	4 <sup>th</sup>	14	1
Year 2	5 <sup>th</sup>	8	1
	6 <sup>th</sup>	6	0
	7 <sup>th</sup>	5	1
	8 <sup>th</sup>	5	0
<b>TOTAL</b>		<b>83</b>	<b>10</b>

The 83 events of worsening depression were reported in 38 subjects and the 10 suicide attempts were reported in 9 subjects.

#### SAFETY DATA FROM EPILEPSY EXPERIENCE (Studies and Post Marketing Data)

The VNS Device has been approved and marketed in the United States for the treatment of refractory epilepsy since 1997. A summary of safety issues related to that use are provided here.

#### Therapeutic Side Effects and Tolerability

In the two randomized, double-blind, controlled epilepsy studies the following adverse events were found to occur more frequently acutely, in either High or Low stimulation, than in baseline in at least one of the two studies (E-03 Low Group Rate, E-05 High Group Rate): These results are shown in Table 15 below.

Table 15. Adverse Events in Epilepsy Studies

Event	E-03 Low Group <sup>1</sup>	E-05 High Group <sup>1</sup>
Voice Alteration	38.6%	72.6%
Cough	12.3%	52.6%
Throat Pain	7.0%	42.1%
Pain	Not Reported	33.7%
Dyspnea	10.5%	27.4%
Paresthesia	15.8%	24.2%
Dyspepsia	Not Reported	21.1%
Vomiting	1.8%	17.9%
Infection	3.5%	14.7%

<sup>1</sup>High Group defined as receiving therapeutic stimulation

#### Analysis of Recent MDR Reports Submitted to FDA

An analysis was performed by FDA's Office of Biometrics and Surveillance (OSB) on all medical device reports (MDR) submitted for the VNS Epilepsy indication from July 1, 1997 through October 8, 2004. This analysis included 2,887 reports, 2,453 of which were reported from sites within the United States. It should be noted that during this time, a total of 32,065 VNS Therapy device implants and 80,144 device years of implant experience had occurred.

Submission or an MDR report does not constitute an admission that medical personnel, user facility, importer, distributor, manufacturer, or product caused or contributed to the events listed.

#### Deaths

A total of 524 deaths have been reported to FDA. Of these, 102 (20%) were of an “unknown cause.” Of those deaths with a reported cause the following were the most common etiologies:

- seizure disorder (152; 29%) including sudden unexplained death in elipepsy and status epilepticus;
- respiratory events (99; 19%) including pneumonia, pulmonary edema, hypoxia;
- cardiac events (51; 10%) including cardiopulmonary arrest, infarction, and arrhythmias;
- neurovascular events (24; 5%) including stroke and cerebral hemorrhage
- malignancy (19; 3%) including brain and colon.

Nine (9) of the deaths were reported from suicide and 39 occurred during sleep.

#### Serious Injuries

A total of 1,644 serious injuries have been reported by the sponsor. The most frequently reported serious injury was infection (525; 32%). Approximately 40% of these were known to have required device explantation. The second most common serious injury reported was increased seizure activity (324; 20%). Others included:

- vagus nerve injury (181; 11%) including vocal cord paralysis (109) and hoarseness (71);
- respiratory injuries (141; 9%) including sleep apnea (33), dyspnea (50), and aspiration (14);
- cardiac events (123; 8%) including tachycardia, bradycardia, palpitations, hypertension, hypotension, syncope, and asystole;
- pain (81; 5%) including chest and neck pain;
- gastrointestinal events (60; 4%) including dysphagia (24) and weight loss (24);
- depression (21; 1%)

Of the 1,644 reports of serious injury, 694 (42%) were associated with subsequent device explantation in that subject.

#### Device Malfunctions

A total of 708 device malfunctions have been reported through the MDR system. Some of the most common malfunctions reported were high lead impedance (351), lead breakage (116), device failure (44), and device migration (20).

## **IX. CONCLUSIONS DRAWN FROM STUDIES**

In conclusion, CDRH believes that the PMA applicant has provided reasonable assurance of safety and effectiveness based on valid scientific evidence as required by statute and regulation for the approval of a Class III medical device. CDRH has come to this conclusion because the sponsor has provided data that were systematically collected and analyzed which showed significant improvement from baseline over one and two years for a definable subset of the target population, and comparative data against a reasonably matched control which also showed sustained improvement over time.

**X. PANEL RECOMMENDATION**

On June 15, 2004, the Neurological Devices Panel, by a vote of 5-2, recommended that the Pre-Market Approval Application (PMA) for the VNS Therapy System for the treatment of chronic or recurrent treatment-resistant depression be found approvable with the following conditions:

1. Patients should have failed four or more trials of traditional treatment modalities for treatment-resistant depression (medications and ECT) prior to use of the device.
2. The device will be implanted by surgeons with appropriate training.
3. Training regarding device electronic programming will be provided for primary care providers.
4. Additional patient labeling for use of the device and identification card be provided.
5. A patient registry to collect clinical data will be established.
6. The physician labeling be revised regarding the following: 12 month open label follow-up, the variable effect of treatment, patient selection, and deletion of imaging claims.

**XI. CDRH DECISION**

CDRH concurred with the Panel's recommendation of June 15, 2004, and issued a letter to Cyberonics, Inc. on February 2, 2005, advising that its PMA was approvable subject to

1. Submission of complete protocols for two post-market clinical studies:
  - a. A 1-year, randomized dose-ranging study and
  - b. A 5-year observational registry study.
2. Revised physician and patient labeling
3. Resolution of Good Manufacturing Processes (GMP) inspection issues
4. Resolution of Bioresearch monitoring issues

In an amendment received by FDA on March 11, 2005, Cyberonics, Inc. submitted the required data. FDA issued an approval order on July 15, 2005. The applicant's manufacturing facility was inspected on June 10, 2005 and was found to be in compliance with the Quality System Regulation (21 CFR 820).

**XII. APPROVAL SPECIFICATIONS**

Directions for use: See the labeling.

Hazards to Health from Use of the Device: See Indications, Contraindications, Warnings, precautions and Adverse Events in the labeling.

Postapproval Requirements and Restrictions: See approval order.

# Depression Physician's Manual

VNS Therapy™ Pulse  
Model 102 Generator

and

VNS Therapy™ Pulse Duo  
Model 102R Generator

July 2005

Caution: U.S. federal law restricts this device  
to sale by or on the order of a physician.



26-0005-6300/10  
© Copyright 2005 Cyberonics, Inc. Houston, Texas  
All rights reserved

## Table of Contents

1-D. BRIEF DEVICE DESCRIPTION .....	1
2-D. INTENDED USE / INDICATIONS .....	2
3-D. CONTRAINDICATIONS .....	3
4-D. WARNINGS .....	5
5-D. PRECAUTIONS .....	11
5.1-D. Sterilization, Storage, and Handling .....	14
5.2-D. Lead Evaluation and Connection .....	14
5.3-D. Environmental and Medical Therapy Hazards .....	15
6-D. CLINICAL STUDIES — SAFETY .....	23
6.1-D. Adverse events .....	23
6.2-D. Serious Adverse Events (SAEs) .....	25
6.3-D. Safety Considerations Specific to Depressed Patients .....	28
6.4-D. Adverse Event (AE) Relationship to VNS Therapy and Duration of Events .....	30
6.5-D. Severity of Adverse Events .....	43
6.6-D. VNS Therapy Continuation Rates .....	43
6.7-D. Device Performance .....	44
6.8-D. Analysis of Medical Device Reports Submitted to the FDA from July 1, 1997 through October 8, 2004 for the VNS Therapy System Epilepsy Indication .....	44
7-D. CLINICAL STUDIES — EFFECTIVENESS .....	47
7.1-D. Feasibility (D-01) Study .....	47
7.2-D. Pivotal (D-02) Study .....	47
7.3-D. Pivotal (D-02) Study, Long-term Phase .....	48

7.4-D. Data Analysis: D-02 and D-04 Studies.....	52
7.5-D. Results: Pivotal Study (D-02).....	55
7.6-D. Results: Comparison of D-02 and D-04 Studies .....	59
7.7-D. Clinical Benefit Over Time.....	62
7.8-D. Maintaining Response (2 Year Data).....	64
7.9-D. Standard-of-Care Antidepressant Treatments During the Long-term Phase of Study D-02 and During Study D-04 .....	66
7.10-D. Bibliography.....	68
8-D. INDIVIDUALIZATION OF TREATMENT .....	69
9-D. PATIENT COUNSELING INFORMATION.....	70
10-D. CONFORMANCE TO STANDARDS .....	71
11-D. HOW SUPPLIED .....	72
12-D. OPERATOR'S MANUAL .....	73
12.1-D. Directions for Use .....	73
12.2-D. Physician Training/Information.....	73
12.3-D. Detailed Device Description.....	74
13-D. CYBERONICS' LIMITED REPLACEMENT WARRANTY.....	75
14-D. TROUBLESHOOTING .....	76
15-D. INFORMATION AND SUPPORT .....	77
16-D. GLOSSARY.....	78

**Tables**

Table D-1. Adverse Events Reported During VNS Therapy at 0-3 Months and 9-12 Months (D-02).....	24
Table D-2. Serious Adverse Events Reported in Study D-02, Regardless of Relationship to Implantation or Stimulation .....	26
Table D-3. Suicide Attempt and Suicide Rates.....	30
Table D-4. Implantation-Related Adverse Events Occurring in Greater Than or Equal To 5% of Subjects During the Acute Phase of the Pivotal (D-02) Study .....	32
Table D-5. Implantation-related Adverse Events Occurring in Less Than 5% of Subjects in Acute Phase - Pivotal (D-02) Study .....	33
Table D-6. D-02 Acute Phase Duration of Treatment-Related Adverse Events Related to Implantation Reported by More Than 10% of Subjects.....	35
Table D-7. Stimulation-Related Adverse Events Occurring in Greater Than or Equal To 5% of Subjects in Treatment Versus Control, Acute Phase - Pivotal (D-02) study .....	36
Table D-8. Stimulation-related Adverse Events Occurring in Less Than 5% of Subjects in the Treatment Group, Acute Phase - Pivotal (D-02) Study.....	37
Table D-9. Stimulation-related Adverse Events Occurring in Greater Than or Equal To 5% of Subjects By Time Intervals After Initiation of Stimulation - Pivotal (D-02) Study .....	38
Table D-10. Stimulation-related Adverse Events Occurring in Less Than 5% of Subjects, Long-term Phase - Pivotal (D-02) Study.....	39

Table D-11. Incidence of First Reported Stimulation-Related Adverse Events Experienced After 3 Months of VNS Therapy.....	40
Table D-12. Duration of Early Stimulation-related Events Through 1 Year (Study D-02).....	42
Table D-13. Description of Subjects in Pivotal (D-02) and Comparative (D-04) Studies.....	51
Table D-14. Responders, Remitters, and Percent Change Pivotal (D-02) Study 12-Month Completer Population.....	58
Table D-15. Stimulation Parameters at 12 months of VNS Therapy in the Pivotal (D-02) Study.....	69
<b>Figures</b>	
Figure D-1. ECG Artifact Produced by Pulse Generator Communication.....	22
Figure D-2. Pivotal Study, Long-Term.....	54
Figure D-3. Responder Quarterly Results for D-02 Evaluable Subjects.....	56
Figure D-4. Remitter Quarterly Results for D-02 Evaluable Subjects.....	57
Figure D-5. Comparison of IDS-SR Scores of Pivotal (D-02) Versus Comparative (D-04) Study Subjects by Quarter (Repeated Measures Linear Regression Analysis), Evaluable Population.....	60
Figure D-6. Secondary Analyses: Categorical Outcomes at 12 Months (Evaluable Observed Analysis).....	61
Figure D-7. Secondary Analyses: CGI-I Categorical Outcome at 12 Months (Evaluable Observed Analysis).....	62
Figure D-8. Clinical Benefit after 3, 12 and 24 months; D-02 Evaluable Population; HRSD <sub>24</sub> .....	63
Figure D-9. Maintenance of Adjunctive VNS Therapy Response (% of HRSD Responders who Maintained Response at 1 and 2 Years).....	65

## 1-D. BRIEF DEVICE DESCRIPTION

Please refer to the Brief Device Description section in the 102/102R Epilepsy Physician's Manual for a brief description of the components of the VNS Therapy System, compatibility, and symbols and definitions used in this manual.

## 2-D. INTENDED USE / INDICATIONS

The VNS Therapy System is indicated for the adjunctive long-term treatment of chronic or recurrent depression\* for patients 18 years of age or older who are experiencing a major depressive episode and have not had an adequate response to four or more adequate antidepressant treatments\*.

\*See glossary for a definition of terms.

## 3-D. CONTRAINDICATIONS



The VNS Therapy System cannot be used in patients after a bilateral or left cervical vagotomy.



Do not use shortwave diathermy, microwave diathermy or therapeutic ultrasound diathermy (hereafter referred to as diathermy) on patients implanted with a VNS Therapy System. Diagnostic ultrasound is not included in this contraindication.

Energy delivered by diathermy may be concentrated into or reflected by implanted products such as the VNS Therapy System. This concentration or reflection of energy may cause heating.

Testing indicates that diathermy can cause heating of the VNS Therapy System well above temperatures required for tissue destruction. The heating of the VNS Therapy System resulting from diathermy can cause temporary or permanent nerve or tissue or vascular damage. This damage may result in pain or discomfort, loss of vocal cord function, or even possibly death if there is damage to blood vessels.

Because diathermy can concentrate or reflect its energy off any size-implanted object, the hazard of heating is possible when any portion of the VNS Therapy System remains implanted, including just a small portion of the Lead or electrode. Injury or damage can occur during diathermy treatment whether the VNS Therapy System is turned "ON" or "OFF".

∞∞



Diathermy is further prohibited because it may also damage the VNS Therapy System components resulting in loss of therapy, requiring additional surgery for system explantation and replacement. All risks associated with surgery or loss of therapy would then be applicable.

Advise your patients to inform all their health care professionals that they should not be exposed to diathermy treatment.

#### 4-D. WARNINGS

Physicians should inform patients about all potential risks and adverse events discussed in the VNS Therapy System physician's manuals.

**⚠** This device is a permanent implant. It is only to be used in patients with severe depression who are unresponsive to standard psychiatric management. It should only be prescribed and monitored by physicians who have specific training and expertise in the management of treatment-resistant depression and the use of this device. It should only be implanted by physicians who are trained in surgery of the carotid sheath and have received specific training in the implantation of this device.

89

**⚠**

#### Not curative

Physicians should warn patients that VNS Therapy has not been determined to be a cure for depression. Patients should be counseled to understand that individual results will likely vary. Beneficial results might not become evident for months. Most patients will continue to require antidepressant medications and/or electroconvulsive therapy (ECT) in addition to VNS Therapy.

**⚠**

#### Unapproved uses

The safety and efficacy of the VNS Therapy System have not been established for uses outside the "Intended Use/Indications" section of the physician's manuals (Depression and Epilepsy), including (but not limited to) patients with:

- Acute suicidal thinking or behavior
  - History of schizophrenia, schizoaffective disorder or delusional disorders
  - History of rapid cycling bipolar disorder
  - History of previous therapeutic brain surgery or CNS injury
  - Progressive neurological diseases other than epilepsy
  - Cardiac arrhythmias or other abnormalities
  - History of dysautonomias
  - History of respiratory diseases or disorders, including dyspnea and asthma
  - History of ulcers (gastric, duodenal, or other)
  - History of vasovagal syncope
  - Only one vagus nerve
  - Other concurrent forms of brain stimulation
  - Pre-existing hoarseness
- ⚠ **Worsening depression/suicidality**  
Patients being treated with adjunctive VNS Therapy should be observed closely for clinical worsening and suicidality, especially at the time of VNS Therapy stimulation parameter changes or drug or drug dose changes, including either increases or decreases in the stimulation parameters or concomitant treatments. Consideration should be given to changing the therapeutic regimen of VNS Therapy or concomitant treatments, including possibly discontinuing VNS Therapy or the concomitant therapy, in patients whose depression is
- ⚠ **Dysfunctional cardiac conduction systems**  
The safety and effectiveness of the VNS Therapy System in patients with predisposed dysfunction of cardiac conduction systems (re-entry pathway) have not been established. Evaluation by a cardiologist is recommended if the family history, patient history, or electrocardiogram suggests an abnormal cardiac conduction pathway. Serum electrolytes, magnesium, and calcium should be documented before implantation. Additionally, postoperative bradycardia can occur among patients with certain underlying cardiac arrhythmias. Post-implant electrocardiograms and Holter monitoring are recommended if clinically indicated.
- ⚠ **It is important to follow recommended implantation procedures and intraoperative product testing described in this manual.** During the intraoperative Lead Test, infrequent incidents of bradycardia and/or asystole have occurred. If asystole, severe bradycardia (heart rate < 40 bpm), or a clinically significant change in heart rate is encountered during a Lead Test or during initiation of stimulation, physicians should be prepared to follow guidelines consistent with Advanced Cardiac Life Support (ACLS). Additionally, postoperative bradycardia can occur among patients with certain underlying cardiac
- ⚠ **It is important to follow recommended implantation procedures and intraoperative product testing described in this manual.** During the intraoperative Lead Test, infrequent incidents of bradycardia and/or asystole have occurred. If asystole, severe bradycardia (heart rate < 40 bpm), or a clinically significant change in heart rate is encountered during a Lead Test or during initiation of stimulation, physicians should be prepared to follow guidelines consistent with Advanced Cardiac Life Support (ACLS). Additionally, postoperative bradycardia can occur among patients with certain underlying cardiac

arrhythmias. If a patient has experienced asystole, severe bradycardia (heart rate < 40 bpm) or a clinically significant change in heart rate during a Lead Test at the time of initial device implantation, the patient should be placed on a cardiac monitor during initiation of stimulation.

The safety of this therapy has not been systematically established for patients experiencing bradycardia or asystole during VNS Therapy System implantation.

#### **Swallowing difficulties**

Difficulty swallowing (dysphagia) may occur with active stimulation, and aspiration may result from the increased swallowing difficulties. Patients with pre-existing swallowing difficulties are at greater risk for aspiration. Appropriate aspiration precautions should be taken for such patients.

#### **Dyspnea or shortness of breath**

Dyspnea (shortness of breath) may occur with active VNS Therapy. Any patient with underlying pulmonary disease or insufficiency such as chronic obstructive pulmonary disease or asthma may be at increased risk for dyspnea and should have their respiratory status evaluated prior to implantation and monitored following initiation of stimulation.

#### **Obstructive sleep apnea**

Patients with obstructive sleep apnea (OSA) may have an increase in apneic events during stimulation. Lowering stimulus frequency or prolonging "OFF" time may prevent exacerbation of OSA. Vagus nerve stimulation may also cause new onset sleep apnea in patients who have not previously been diagnosed with this disorder. It is

recommended that patients being considered for VNS Therapy who demonstrate signs or symptoms of OSA, or who are at increased risk for developing OSA, should undergo the appropriate evaluation(s) prior to implantation.

#### **Device malfunction**

Device malfunction could cause painful stimulation or direct current stimulation. Either event could cause nerve damage and other associated problems. Patients should be instructed to use the Magnet to stop stimulation if they suspect a malfunction, and then to contact their physician immediately for further evaluation. Prompt surgical intervention may be required if a malfunction occurs.

#### **MRI**

Patients with the VNS Therapy System or any part of the VNS Therapy System implanted should not have full body MRI. Additional surgery may be required to remove the VNS Therapy system if full body MRI is required. See "Magnetic resonance imaging" in this manual for details.

#### **Excessive stimulation**

**Note:** Use of the Magnet to activate stimulation is not recommended for patients with depression. The Magnet Mode output current should remain at 0.0mA for patients with depression.

Excessive stimulation at an excess duty cycle (that is, one that occurs when "ON" time is greater than "OFF" time) has resulted in degenerative nerve

damage in laboratory animals. An excess duty cycle can be produced by continuous or frequent magnet activation (> 8 hours), as determined by animal studies. Do not stimulate at these combinations of ranges.



**Device manipulation**

Patients who manipulate the Pulse Generator and Lead through the skin (Twiddler's Syndrome) may damage or disconnect the Lead from the Pulse Generator and/or possibly cause damage to the vagus nerve. Patients should be warned against manipulating the Pulse Generator and Lead.

**5-D. PRECAUTIONS**

Physicians should inform patients about all potential risks and adverse events discussed in the VNS Therapy System physician's manuals.

 **Appropriate physician training is very important.**

- **Prescribing physicians should be experienced in the diagnosis and treatment of depression and should be familiar with the programming and use of the VNS Therapy System.**
- **Physicians who implant the VNS Therapy System should be experienced performing surgery in the carotid sheath and should be trained in the surgical technique relating to implantation of the VNS Therapy System. (See the "Physician Training/Information" section of the Physician's Manual.)**



**Use during pregnancy**

The safety and effectiveness of the VNS Therapy System have not been established for use during pregnancy. There are no adequate and well-controlled studies of VNS Therapy in pregnant women. Reproduction studies have been performed using female rabbits stimulated with the commercially available VNS Therapy System at stimulation dose settings similar to those used for humans. These animal studies have revealed no evidence of impaired fertility or harm to the fetus due to VNS Therapy. Because animal reproduction studies are not always predictive of human

response and animal studies cannot address developmental abnormalities, VNS Therapy should be used during pregnancy only if clearly needed. Although the operating ranges of the VNS Therapy System and fetal monitors are dissimilar and no interaction would be expected, testing has not been performed. Therefore, the potential may exist for interaction between the VNS Therapy System and fetal monitoring systems.



The VNS Therapy System is indicated for use only in stimulating the left vagus nerve in the neck area inside the carotid sheath. The VNS Therapy System is indicated for use only in stimulating the left vagus nerve below where the superior and inferior cervical cardiac branches separate from the vagus nerve. The safety and efficacy of the VNS Therapy System have not been established for stimulation of the right vagus nerve or of any other nerve, muscle, or tissue.



It is important to follow infection control procedures. Infections related to any implanted device are difficult to treat and may require that the device be explanted. The patient should be given antibiotics preoperatively. The surgeon should ensure that all instruments are sterile prior to the operation.

Frequent irrigation of both incision sites with generous amounts of bacitracin or equivalent solution should be performed prior to closure. To minimize scarring, these incisions should be closed with cosmetic closure techniques. Also, antibiotics should be administered postoperatively at the discretion of the physician.

12



**Effects on other medical devices**  
The VNS Therapy System may affect the operation of other implanted devices, such as cardiac pacemakers and implanted defibrillators. Possible effects include sensing problems and inappropriate device responses. If the patient requires concurrent implantable pacemaker, defibrillator therapy or other types of stimulators, careful programming of each system may be necessary to optimize the patient's benefit from each device. Furthermore, when the VNS Therapy System and another stimulator are implanted in the same patient, the two stimulators should be placed at least four inches (10 centimeters) apart to avoid communication interference. Users should refer to the product labeling for the concurrent device to determine if there are additional precautions that should be observed.



**Reversal of Lead polarity has been associated with an increased chance of bradycardia in animal studies.** It is important that the electrodes are attached to the left vagus nerve in the correct orientation. It is also important to make sure that leads with dual connector pins are correctly inserted (white marker band/serial number to + connection) into the lead receptacle(s).



The patient can use a neck brace for the first week to help ensure proper lead stabilization.

- ⚠ **Do not program the VNS Therapy System to an ON or periodic stimulation treatment for at least 14 days after the initial or replacement implantation.** Failure to observe this precaution may result in patient discomfort or adverse events.
- ⚠ **Do not use frequencies of 5 Hz or below for long-term stimulation.** Because these frequencies generate an electromagnetic trigger signal, their use results in excessive battery depletion of the implanted Pulse Generator and, therefore, should be used for short periods of time only.
- ⚠ **Resetting the Pulse Generator turns the device OFF (output current = 0.0 mA), and all device history information is lost.** The device history information should be printed out before resetting.
- ⚠ **Laryngeal irritation may result from stimulation.** Patients who smoke may have an increased risk of laryngeal irritation.

**5.1-D. Sterilization, Storage, and Handling**  
Please refer to the Sterilization, Storage, and Handling section in the 102/102R Epilepsy Physician's Manual for information on sterilization, storage, and handling of the VNS Therapy System.

**5.2-D. Lead Evaluation and Connection**  
Please refer to the Lead Evaluation and Connection section in the 102/102R Epilepsy Physician's Manual for information on evaluating and connecting the Lead component of the VNS Therapy System.

14

**5.3-D. Environmental and Medical Therapy Hazards**

- ⚠ **Patients should exercise reasonable caution in avoiding devices that generate a strong electric or magnetic field.** (For examples, see the "Other Environmental Hazards" below.) If a Pulse Generator ceases operation while in the presence of electromagnetic interference (EMI), moving away from the source may allow it to return to its normal mode of operation.

**5.3.1-D. Hospital and Medical Environments**

- ⚠ **VNS Therapy System operation should always be checked by performing device diagnostics after any of the procedures mentioned in this manual.** Additional precautions for these procedures are described below.

- ⚠ **For clear imaging, patients may need to be specially positioned for mammography procedures because of the location of the Pulse Generator in the chest.** (Most routine diagnostic procedures, such as fluoroscopy and radiography, are not expected to affect system operation.)

- ⚠ **Therapeutic radiation may damage the Pulse Generator's circuitry, although no testing has been done to date and no definite information on radiation effects is available.** Sources of such radiation include therapeutic radiation, cobalt machines, and linear accelerators. The radiation effect is cumulative, with the total dosage

15

determining the extent of damage. The effects of exposure to such radiation can range from a temporary disturbance to permanent damage, and may not be detectable immediately.



External defibrillation may damage the Pulse Generator. Attempt to minimize current flowing through the Pulse Generator and Lead system by following these precautions:

- Position defibrillation paddles perpendicular to the Pulse Generator and Lead system and as far from the Pulse Generator as possible.
- Use the lowest clinically appropriate energy output (watt-seconds).
- Confirm Pulse Generator function after any internal or external defibrillation.



Use of electrocautery (electrocautery or radio frequency (RF) ablation devices) may damage the Pulse Generator. Attempt to minimize the current flowing through the Pulse Generator and Lead system by following these precautions:

- Position the electrocautery electrodes as far as possible from the Pulse Generator and Lead.
- Avoid electrode placement that puts the Pulse Generator or Lead in the direct path of current flow or within the part of the body being treated.
- Confirm that the Pulse Generator functions as programmed after electrocautery.



Magnetic resonance imaging (MRI) should not be performed with a magnetic resonance body coil in the transmit mode. The heat induced in the Lead by an MRI body scan can cause injury.

If an MRI should be done, use only a transmit and receive type of head coil. Magnetic and RF fields produced by MRI may change the Pulse Generator settings (change to reset parameters) or activate the device. Stimulation has been shown to cause the adverse events reported in the "Adverse Events" section of this manual. MRI compatibility was demonstrated using a 1.5T General Electric Signa Imager with a Model 100 only. The Model 102 and Model 102R are functionally equivalent to the Model 100. Testing on this imager as performed on a phantom<sup>1</sup> indicated that the following Pulse Generator and MRI procedures can be used safely without adverse events:

- Pulse Generator output programmed to 0 mA for the MRI procedure, and afterward, retested by performing the Lead Test diagnostics and reprogrammed to the original settings
- Head coil type: transmit and receive only
- Static magnetic field strength:  $\leq 2.0$  tesla
- Specific absorption rate (SAR):  $< 1.3$  W/kg for a 154.5-lb (70-kg) patient
- Time-varying intensity:  $< 10$  tesla/sec

<sup>1</sup> A phantom is a material resembling a body in mass, composition, and dimensions that is used to measure absorption of radiation.

Use caution when other MRI systems are used, since adverse events may occur because of different magnetic field distributions. Consider other imaging modalities when appropriate.

⚠ Procedures in which the RF is transmitted by a body coil should not be done on a patient who has the VNS Therapy System. Thus, protocols must not be used that utilize local coils that are RF-receive only, with RF-transmit performed by the body coil. Note that some RF head coils are receive-only, and that most other local coils, such as knee and spinal coils, are also RF receive-only. These coils must not be used in patients with the VNS Therapy System.

⚠ Extracorporeal shockwave lithotripsy may damage the Pulse Generator. If therapeutic ultrasound is required, avoid positioning the area of the body where the Pulse Generator is implanted in the water bath or in any other position that would expose it to ultrasound therapy. If that positioning cannot be avoided, program the Pulse Generator output to 0 mA for the treatment, and then after therapy, reprogram the Pulse Generator to the original parameters.

⚠ If the patient receives medical treatment for which electric current is passed through the body (such as from a TENS unit) either the Pulse Generator output should be set to 0 mA or function of the Pulse Generator should be monitored during initial stages of treatment.

⚠ Therapeutic ultrasound. Routine therapeutic ultrasound could damage the Pulse Generator and may be inadvertently concentrated by the device, causing harm to the patient.

**5.3.2-D. Home Occupational Environments**  
Properly operating microwave ovens, electrical ignition systems, power transmission lines, theft-prevention devices, and metal detectors are not expected to affect the Pulse Generator. Similarly, most routine diagnostic procedures, such as fluoroscopy and radiography, are not expected to affect system operation. However, because of their higher energy levels, sources such as transmitting antennas may interfere with the VNS Therapy System. It is suggested that the Pulse Generator be moved away from equipment—typically at least six feet (1.8 meters)—that may be causing interference.

⚠ The patient should seek medical advice before entering environments that are protected by a warning notice preventing entry by patients implanted with a cardiac pacemaker or defibrillator.

**5.3.3-D. Cellular Phones**  
Based on testing to date, cellular phones have no effect on Pulse Generator operation. Unlike an implanted pacemaker or defibrillator, the Pulse Generator does not sense physiologic signals.



#### 5.3.4-D. Other Environmental Hazards

⚠ Strong magnets, hair clippers, vibrators, loudspeaker magnets, Electronic Article Surveillance (EAS) System tag deactivators, and other similar electrical or electro-mechanical devices, which may have a strong static or pulsing magnetic field, can cause accidental magnet activation. Patients should be cautioned to keep such devices away from the Pulse Generator, typically at least six inches (15 centimeters) away.

#### 5.3.5-D. Programming Software

The Pulse Generator can be programmed using the Model 250 Software, Version 4.6, Version 6.1, Version 7.0 or higher. The Software should be used on a laptop or handheld computer dedicated only to programming the VNS Therapy System. (For more information, see the Model 250 Software Physician's Manual for Version 4.6, Version 6.1, Version 7.0, or higher, including a list of computers that have been qualified for use with this Software.)

#### 5.3.6-D. Pulse Generator and EMI Effects on Other Devices

During stimulation, the Pulse Generator may interfere with devices operating in the 30 kHz to 100 kHz range, such as pocket transistor radios and hearing aids. This interference is a theoretical possibility, and no effects on hearing aids have yet been reported, although the Pulse Generator can interfere with a transistor radio when held directly over one. No specific testing has been done to date, and no definite information on effects is available.

The Pulse Generator should be moved—typically at least 6 feet (1.8 meters)—away from equipment with which it may be interfering.

Programming or interrogating the Pulse Generator may momentarily interfere with other sensitive electronic equipment nearby. The Pulse Generator is not expected to trigger airport metal detectors or theft-protection devices that are closer than about 6 feet (1.8 meters).

⚠ The Pulse Generator may affect the operation of other implanted devices, such as cardiac pacemakers and implantable defibrillators. Possible effects include sensing problems and inappropriate Pulse Generator responses. If the Pulse Generator patient requires concurrent implantable pacemaker and/or defibrillator therapy, careful programming of each system is necessary to optimize the patient's benefit from each device.

⚠ The magnet provided for activation or inhibition of the Pulse Generator may damage televisions, computer disks, credit cards, and other items affected by strong magnetic fields.

#### 5.3.7-D. Effects on ECG Monitors

Pulse Generator data communication produces an ECG artifact, an example of which is shown in the ECG tracings in Figure D-1.

**Figure D-1. ECG Artifact Produced by Pulse Generator Communication**

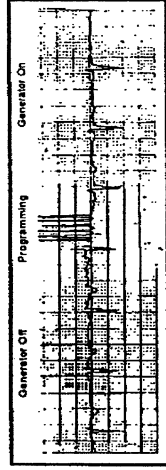

**5.3.8-D. Pulse Generator Disposal**

- ⚠ Do not incinerate the Pulse Generator, because it can explode if subjected to incineration or cremation temperatures.
- ⚠ Return all explanted Pulse Generators to Cyberonics for examination and safe disposal.
- ⚠ Do not implant an explanted Pulse Generator in another patient, because sterility, functionality, and reliability cannot be ensured.

**6-D. CLINICAL STUDIES — SAFETY**

Except where noted otherwise, the safety information presented in this section derives from the pivotal (D-02) study. The D-02 study of VNS Therapy consisted of both an acute and a long-term phase to collect data regarding the safety and efficacy of VNS Therapy as an adjunctive treatment for persons with chronic or recurrent treatment-resistant depression.

**6.1-D. Adverse events**

The number (and percentage) of subjects reporting an adverse event during the 0-3 month period and during the 9-12 month period of the pivotal (D-02) study is depicted in Table D-1 for the most commonly reported adverse events. Adverse events were coded using the COSTART 5 dictionary. Note that some subjects may have reported multiple events.

**Table D-1. Adverse Events Reported During VNS Therapy at 0-3 Months and 9-12 Months (D-02)**

Adverse Event	0-3 Months (N=222)	9-12 Months (N=209)
Voice Alteration	135 (60.8%)	113 (54.1%)
Increased Cough	55 (24.8%)	13 (6.2%)
Neck Pain	38 (17.1%)	27 (12.9%)
Dyspnea	33 (14.9%)	34 (16.3%)
Dysphagia	31 (13.9%)	9 (4.3%)
Parosmia	28 (12.6%)	9 (4.3%)
Laryngismus	23 (10.4%)	10 (4.8%)
Pharyngitis	14 (6.3%)	11 (5.3%)
Nausea	13 (5.9%)	4 (1.9%)
Pain	13 (5.9%)	13 (6.2%)
Headache	12 (5.4%)	8 (3.8%)
Insomnia	10 (4.5%)	2 (1.0%)
Palpitation	9 (4.1%)	6 (2.9%)
Chest Pain	9 (4.1%)	4 (1.9%)
Dysosmia	8 (3.6%)	4 (1.9%)
Hypertonia	6 (2.7%)	10 (4.8%)
Hyposthesia	6 (2.7%)	2 (1.0%)
Anxiety	5 (2.3%)	6 (2.9%)
Ear Pain	5 (2.3%)	6 (2.9%)
Eructation	4 (1.8%)	0
Diarrhea	4 (1.8%)	2 (1.0%)
Dizziness	4 (1.8%)	3 (1.4%)
Incision Site Reaction	4 (1.8%)	2 (1.0%)
Asthma	4 (1.8%)	3 (1.4%)
Device Site Reaction	4 (1.8%)	0
Device Site Pain	4 (1.8%)	2 (1.0%)
Migraine Headache	4 (1.8%)	2 (1.0%)

It is important to note that subjects often had comorbid illnesses and almost all study subjects were also receiving antidepressant and other drugs that could have contributed to these events.

**6.1.1-D. Discontinuation Due to Adverse Events**

In the feasibility (D-01) study, no discontinuations were related to adverse events attributed to VNS Therapy or the implant procedure. By the time all continuing subjects in the pivotal (D-02) study had at least 1 year of VNS Therapy, 3% (8/235) of the subjects had discontinued VNS Therapy for an adverse event-related reason. The reasons for these eight discontinuations included one case each of suicide, implant-related infection necessitating device removal, hoarseness, lightheadedness, post-operative pain, chest and arm pain, sudden death (of unknown cause), and worsening depression (reported by the investigator as an adverse event rather than as lack of efficacy).

**6.2-D. Serious Adverse Events (SAEs)**

**6.2.1-D. Serious Adverse Events (SAEs)**

The SAEs described in this section are based on investigator reports from the pivotal (D-02) study from study initiation through the data cutoff date for submission; the data cutoff date included the entire period of evaluation for subjects who did not complete 12 months of VNS Therapy and included a minimum of 12 months of evaluation during VNS Therapy for all subjects who continued the study for 12 months or longer.

During the pivotal (D-02) study, 12 SAEs were considered related to the implant procedure (wound infection, asystole, bradycardia, syncope, abnormal thinking, vocal cord paralysis, aspiration pneumonia, voice alteration, device site reaction [two reports], acute renal failure, and urinary retention). During the acute phase of the D-02 study, investigators did not report any

SAE to be related to stimulation. During the long-term phase of the D-02 study, eight SAEs were considered at least possibly related to stimulation (sudden death of unknown cause, syncope (two reports), dizziness, a manic depressive reaction in a subject with bipolar disorder, hemorrhage GI, paresthesia, and an incident of worsening depression. Table D-2 displays all the SAEs reported during the D-02 study prior to the data cutoff date, regardless of relationship to implantation or stimulation.

**Table D-2. Serious Adverse Events Reported in Study D-02, Regardless of Relationship to Implantation or Stimulation**

Event	Acute (N=235)		Long Term (N=233)	
	Number of Events Treatment (N=119) (Sham)	Number of Subjects	Number of Events	Number of Subjects
Worsening Depression	5/7	11	82	31
Suicide Attempt	0	0	7	6
Syncope	0	0	4	3
Dehydration	1/1	2	1	1
Wound Infection	1/0	1	1	1
Cholecystitis	0/1	1	1	1
Gastrointestinal Disorder	0	0	2	2
Abnormal Thinking	1/0	1	1	1
Convulsion	0	0	2	2
Device Site Reaction	2/0	2	0	0
Pneumonia	0/1	1	0	0
Abdominal Pain	0	0	1	1
Accidental Injury	0	0	1	1
Chest Pain	0	0	1	1
Overdose	0	0	1	1
Peritonitis	0	0	1	1
Sudden Unexplained Death	0	0	1	1

Event	Acute (N=235)		Long Term (N=233)	
	Number of Events Treatment (N=119) (Sham)	Number of Subjects	Number of Events	Number of Subjects
Suicide	1/0	1	0	0
Surgical Procedure	0	0	1	1
Asystole	1/0	1	0	0
Bradycardia	1/0	1	0	0
Cholelithiasis	0	0	1	1
Constipation	0	0	1	1
Myasthenia	0/1	1	0	0
Confusion	1/0	1	0	0
Dizziness	0	0	1	1
Drug Dependence	0	0	1	1
Manic Depression	0	0	1	1
Somnolence	0	0	1	1
Vocal Cord Paralysis	0/1	1	0	0
Breast Cancer	0	0	1	1
Aspiration Pneumonia	1/0	1	0	0
Voice Alteration	0/1	1	0	0
Acute Renal Failure	0	0	1	1
Enlarged Uterine Fibroid	0	0	1	1
Urinary Retention	1/0	1	0	0

**6.2.2-D. Deaths**

Four deaths occurred during the pivotal (D-02) study: one after the subject had given consent, but before the subject was implanted; the second, a suicide; the third, a death of unknown cause; and the fourth, a subject who developed multi-organ failure.

#### 6.2.3-D. Unanticipated Adverse Device Effects

Two events in the pivotal (D-02) study met criteria for an unanticipated adverse device effect (UADE)—see Glossary for definition. Both these events were non-specific complications of surgery related to the implant procedure and occurred before stimulation began. One UADE was an episode of acute renal failure thought to be secondary to antibiotic administration, and the other was an episode of altered mental status thought to be due to perioperative narcotic administration.

#### 6.3-D. Safety Considerations Specific to Depressed Patients

Two specific safety concerns in the use of all antidepressant therapies are the precipitation of manic or hypomanic episodes and the possible effect of antidepressant therapy on suicidal ideation and behavior.

##### 6.3.1-D. Antidepressant Treatments and Manic or Hypomanic Reaction

Although patients with bipolar disorder experience manic episodes as the cardinal feature of their disorder, effective antidepressant therapies themselves can occasionally precipitate a manic or hypomanic episode. Antidepressant therapies can also occasionally precipitate a manic or hypomanic episode in patients without a prior history of mania who are being treated for a major depressive episode.

##### 6.3.1.1-D. Manic Reactions

In the pivotal (D-02) study, six hypomanic or manic reactions were identified according to DSM IV criteria or the Young Mania Rating Scale (YMRS). Five were observed in subjects with a known history of prior

hypomanic or manic episodes. One of the events was considered serious and the subject was hospitalized.

##### 6.3.2-D. Suicidal Ideation, Suicide Attempts, Suicide, and Worsened Depression

Suicidal ideation was analyzed by examining the HRSD<sub>24</sub> Item 3 scores. At 12 months of VNS Therapy, 90% of the subjects in the pivotal (D-02) study showed either improvement (56%) or no change (34%) in their Item 3 scores. During the acute D-02 study, 2.6% of the sham subjects and 1.7% of the stimulation subjects increased their Item 3 score by 2 or more points, indicative of an increase in suicidal ideation. During the long-term D-02 phase, 2.8% of the subjects had an increase in their Item 3 score by at least 2 points at 12 months compared to baseline. In a non-randomized control group of subjects treated with standard antidepressant therapies without VNS Therapy (the D-04 study population), 1.9% of the subjects had an increase of at least 2 points. Based on the occurrence of any increase in Item 3 score from baseline to 12 months, 10% of the D-02 subjects had an increase compared to 11% of the D-04 population. Conversely, 27% of the D-02 subjects decreased their score by at least 2 points at 12 months compared to baseline, whereas only 9% of the D-04 subjects did.

Suicide attempts and completed suicides in the D-02 and D-04 studies are shown in Table D-3. As noted above, one subject committed suicide in the acute phase and six attempted suicide during the long-term phase of the D-02 study (N = 235). One of the six subjects noted in the long-term phase attempted suicide twice. Although safety data were not prospectively collected for the D-04 study, the health care utilization form documented suicide attempts.

Three suicide attempts were reported for the D-04 study through the first year of the study (N=124).

**Table D-3. Suicide Attempt and Suicide Rates**

	Number of Patients	Patient Years	Suicide Attempts/Patient Years	Suicide/Patient Years
D-02	235	502	2.4%	0.2%
D-04	124	118	2.5%	0.8%

In the acute phase of the D-02 study, there were 12 reports of worsening depression, 5 in the stimulation group (4 of 119 subjects) and 7 in the sham group (7 of 116 subjects). One of the treatment-group reports occurred prior to stimulation initiation. Following acute phase exit and during the long-term phase of stimulation, 62 events were reported in 31 subjects. The number of episodes of worsening depression per subject ranged from 1 to 6. Although specific rates of worsening depression (and other safety endpoints) were not collected during the D-04 study, "hospitalizations for psychiatric illness," which might be a reasonable surrogate for worsening depression, were recorded. The rate of this event was 0.237 events per patient-year in the D-04 group compared to 0.293 events of worsening depression per patient-year in the D-02 group.

**6.4-D. Adverse Event (AE) Relationship to VNS Therapy and Duration of Events**

The pivotal (D-02) study investigators determined whether an adverse event (AE) was possibly, probably, or definitely related to implantation of, or stimulation by, the VNS Therapy Pulse Generator and Lead.

**6.4.1-D. Adverse Events Related to Implantation**  
 Because all eligible study subjects in the pivotal (D-02) study were implanted with the VNS Therapy System device, no control was available to assess whether an adverse event was related to the surgery. Investigators, therefore, determined which adverse events were related to implantation. The events reported as related to implantation and occurring in at least 10% of the subjects who received VNS Therapy System implants in the pivotal (D-02) study were device site pain, device site reaction, incision pain, dysphagia, hypesthesia, pharyngitis, voice alteration, and incision site reaction. The complete list of implantation-related adverse events is shown in Table D-4 and Table D-5.

**Table D-4. Implantation-Related Adverse Events Occurring in Greater Than or Equal To 5% of Subjects During the Acute Phase of the Pivotal (D-02) Study**

	D-02 Acute Phase Incidence of Surgery-Related AEs (n=235)
<b>Body as a Whole</b>	
Incision Pain	36%
Device Site Pain	23%
Device Site Reaction	14%
Headache	8%
Neck Pain	7%
<b>Digestive System</b>	
Dysphagia	11%
Nausea	9%
<b>Nervous System</b>	
Hypesthesia	11%
Paresthesia	6%
<b>Respiratory System</b>	
Voice Alteration	33%
Pharyngitis	13%
Dyspnea	9%
Cough Increased	6%
<b>Skin and Appendages</b>	
Incision Site Reaction	28%

**Table D-5. Implantation-related Adverse Events Occurring in Less Than 5% of Subjects in Acute Phase - Pivotal (D-02) Study**

<b>Body as a Whole</b>
Abdominal Pain, Allergic Reaction, Anaphylactic Reaction, Asthenia, Back Pain, Chest Pain, Chills, Fever, Infection, Injection Site Pain, Neck Rigidity, Photosensitivity Reaction, Surgical Injury, Viral Infection, Wound Infection
<b>Cardiovascular System</b>
Arrhythmia, Asystole, Bradycardia, Hemorrhage, Migraine, Palpitation, Syncope, Tachycardia
<b>Digestive System</b>
Anorexia, Constipation, Diarrhea, Dyspepsia, Flatulence, Gastrointestinal Disorder, Vomiting
<b>Endocrine System</b>
Thyroid Disorder
<b>Hemid and Lymphatic System</b>
Echymosis, Lymphadenopathy
<b>Metabolic and Nutritional Disorders</b>
Edema, Hyperglycemia, Peripheral Edema
<b>Musculoskeletal</b>
Athralgia, Joint Disorder, Myalgia, Myasthenia
<b>Nervous System</b>
Abnormal Dreams, Agitation, Ataxia, Dizziness, Hypertonia, Insomnia, Nervousness, Neuralgia, Neuropathy, Thinking Abnormal, Tremor, Vasodilatation, Vocal Cord Paralysis
<b>Respiratory System</b>
Aspiration Pneumonia, Asthma, Atelectasis, Bronchitis, Hiccup, Hypoxia, Laryngismus, Laryngitis, Lung Disorder, Respiratory Disorder, Rhinitis, Sinusitis, Sputum Increased
<b>Skin and Appendages</b>
Application Site Reaction, Maculopapular Rash, Pruritus, Rash, Sweating
<b>Social Senses</b>
Ear Disorder, Ear Pain, Tinnitus
<b>Urogenital</b>
Acute Kidney Failure, Dysuria, Hemorrhagia, Urinary Retention

**6.4.2-D. Duration of Implant-Related Adverse Events**  
 As can be seen in Table D-6, many of the individual incidences of the most common implantation-related AEs resolved within 30 days. Hypesthesia (generally described as a localized numbness) and voice alteration, however, tended to be more persistent in some individuals. For example, in 17 of 24 reports of implantation-related hypesthesia, the event continued beyond 3 months. Hypesthesia would be an expected side effect of nerve injury during surgery. The persistence of voice alteration in some subjects is difficult to assess because it could represent surgical injury to the innervation of the larynx, but vagus nerve stimulation itself can cause voice alteration.

**Table D-6. D-02 Acute Phase Duration of Treatment- Emergent Adverse Events Related to Implantation Reported by More Than 10% of Subjects**

Body System	Preferred Term	Duration to Resolution of Event in Days by all Implanted Subjects				
		1 - 7 Days	8 - 14 Days	15 - 30 Days	31 - 60 Days	61 - 90 Days
Body as a Whole	Device Site Pain	27	4	9	9	3
	Device Site Reaction	5	5	8	9	2
	Incision Pain	28	18	21	10	3
Digestive System	Dysphagia	2	5	9	5	2
Nervous System	Hypesthesia	0	0	3	2	2
Respiratory System	Pharyngitis	10	8	10	2	0
	Voice Alteration	11	7	22	17	3
Skin and Appendages	Incision Site Reaction	19	16	24	16	2

Total N = 235 through 30 days, 234 for 31 to 90, 233 for >90 days  
 Number within each box indicates number of subjects whose event resolved within the days shown (i.e. 27 subjects had the event of device site pain resolve within 7 days)



**6.4.3-D. Stimulation-related Adverse Events**

Among AEs judged by investigators to be stimulation-related in the D-02 study acute phase treatment group, seven events occurred at a frequency of 10% or greater: voice alteration (55%), cough increased (24%), dyspnea (19%), neck pain (16%), dysphagia (13%), laryngismus (11%), and paresthesia (10%).

Table D-7 and Table D-8 list stimulation-related adverse events that occurred during the acute phase of the pivotal (D-02) study.

**Table D-7. Stimulation-Related Adverse Events Occurring in Greater Than or Equal To 5% of Subjects in Treatment Versus Control, Acute Phase - Pivotal (D-02) study.**

	D-02 Treatment (n=119)	D-02 Sham-control (n=116)
Body as a Whole		
Inclision Pain	5 (5%)	3 (3%)
Neck Pain	19 (16%)	1 (<1%)
Digestive System		
Dysphagia	15 (13%)	0 (0%)
Nausea	8 (7%)	1 (<1%)
Nervous System		
Paresthesia	12 (10%)	3 (3%)
Respiratory System		
Cough increased	28 (24%)	2 (2%)
Dyspnea	23 (19%)	2 (2%)
Laryngismus	13 (11%)	0 (0%)
Pharyngitis	9 (8%)	1 (<1%)
Voice Alteration	65 (55%)	3 (3%)

\*Note: These subjects were not receiving stimulation during this phase.

**Table D-8. Stimulation-related Adverse Events Occurring in Less Than 5% of Subjects in the Treatment Group, Acute Phase - Pivotal (D-02) Study**

Body as a Whole
Abnormal Chest Pain, Device Site Pain, Device Site Reaction, Headache, Neck Rigidity, Pain
Cardiovascular System
Migraine, Palpitation, Postural Hypotension, Syncope, Tachycardia
Digestive System
Anorexia, Constipation, Diarrhea, Dyspepsia, Eructation, Flatulence, Increased Appetite, Vomiting
Metabolic and Nutritional Disorders
Weight Gain
Musculoskeletal
Myalgia, Myasthenia
Nervous System
Abnormal Dreams, Agitation, Depression, Dizziness, Emotional Lability, Hypertonia, Hypesthesia, Insomnia, Manic Reaction, Nervousness, Sleep Disorder, Somnolence, Twitching, Vasodilatation
Respiratory System
Asthma, Hiccups, Respiratory Disorder, Rhinitis
Skin and Appendages
Inclision Site Reaction
Special Senses
Ear Pain, Tinnitus
Urogenital
Amenorrhea

**6.4.4-D. Stimulation-related Events, Long-term Phase**

Table D-9 lists stimulation-related adverse events that occurred at an incidence of  $\geq 5\%$  during the pivotal (D-02) study. These adverse events were observed over quarters of stimulation. Note that this table also includes observations after 24 months of treatment. Subjects are counted only once within each preferred descriptive term, e.g., neck pain, nausea, pharyngitis, and time interval. Table D-10 lists stimulation-related adverse events that occurred at an incidence of  $< 5\%$  during the long-term phase of the D-02 study.

**Table D-9. Stimulation-related Adverse Events Occurring in Greater Than or Equal To 5% of Subjects By Time Intervals After Initiation of Stimulation - Pivotal (D-02) Study**

	0-3 Mos. n=232	>3-6 Mos. n=225	>6-9 Mos. n=217	>9-12 Mos. n=209	>12 Mos. n=184
<b>Body as a Whole</b>					
Neck Pain	16%	11%	14%	13%	15%
Pain	6%	7%	5%	6%	5%
Headache	5%	4%	4%	3%	3%
<b>Digestive System</b>					
Dysphagia	13%	8%	7%	5%	5%
Nausea	6%	2%	2%	1%	1%
<b>Nervous System</b>					
Parosmia	11%	7%	3%	4%	4%
<b>Respiratory System</b>					
Voice Alteration	58%	60%	58%	54%	52%
Cough	24%	10%	8%	7%	4%
<b>Increased</b>					
Dyspnea	14%	16%	15%	16%	14%
Laryngismus	10%	8%	8%	6%	5%
Pharyngitis	6%	4%	4%	5%	4%

**Table D-10. Stimulation-related Adverse Events Occurring in Less Than 5% of Subjects, Long-term Phase - Pivotal (D-02) Study**

<b>Body as a Whole</b>
Abdominal Pain, Asthenia, Chest Pain, Device Site Pain, Device Site Reaction, Flu Syndrome, Incision Pain, Neck Rigidity, Sudden Unexplained Death, Viral Infection
<b>Cardiovascular System</b>
Bradycardia, Hypotension, Migraine, Palpitation, Postural Hypotension, Syncope, Tachycardia
<b>Digestive System</b>
Aorenia, Colitis, Constipation, Diarrhea, Dyspepsia, Eructation, Flatulence, Gasitis, Gastrointestinal Disorder, Increased Appetite, Vomiting
<b>Metabolic and Nutritional Disorders</b>
Weight Gain, Weight Loss
<b>Musculoskeletal</b>
Athralgia, Joint Disorder, Myalgia
<b>Nervous System</b>
Abnormal Dreams, Agitation, Amnesia, Anxiety, Contusion, Depression, Dizziness, Dry Mouth, Emotional Lability, Hyperension, Hypertonia, Hypoesthesia, Insomnia, Manic Reaction, Manic Depressive Reaction, Nervousness, Sleep Disorder, Somnolence, Speech Disorder, Thinking Abnormal, Tremor, Twitching, Association, Vocal Cord Paralysis
<b>Respiratory System</b>
Asthma, Hiccups, Respiratory Disorder, Rhinitis, Stridor
<b>Skin and Appendages</b>
Incision Site Reaction, Sweating
<b>Special Senses</b>
Amblyopia, Deafness, Ear Pain, Eye Pain, Tinnitus
<b>Urogenital</b>
Amenorrhea, Menstrual Disorder

**6.4.5-D. Late-emerging Adverse Events**

After the first 3 months of stimulation, the incidence of first-reported (new event types) stimulation-related adverse events did not exceed 1.3% of total study subjects for any event (see Table D-11).

**Table D-11. Incidence of First Reported Stimulation-Related Adverse Events Experienced After 3 Months of VNS Therapy**

Body System	COSTART Term	Treatment Group (N=117) N (%)	Delayed Treatment Group (N=116) N (%)	Total (N=233) N (%)
Body as a Whole	Back Pain	1 (<1%)	0	1 (<1%)
	Flu	1 (<1%)	0	1 (<1%)
	Sudden Unexplained Death	1 (<1%)	0	1 (<1%)
	Viral Infection	1 (<1%)	0	1 (<1%)
	Hypotension	1 (<1%)	0	1 (<1%)
Cardiovascular System	Syncope	3 (3%)	0	3 (1%)
	Cellulitis	2 (2%)	0	2 (<1%)
Digestive System	Gastritis	2 (2%)	1 (<1%)	3 (1%)
	Weight Gain	1 (<1%)	2 (2%)	3 (1%)
Metabolic and Nutritional Disorders	Weight Loss	1 (<1%)	0	1 (<1%)
	Arthralgia	0	1 (<1%)	1 (<1%)
Musculoskeletal System	Joint Disorder	0	1 (<1%)	1 (<1%)
	Myalgia	0	1 (<1%)	1 (<1%)
	Speech Disorder	0	1 (<1%)	1 (<1%)
Nervous System	Vocal Cord Paralysis	0	1 (<1%)	1 (<1%)
	Stridor	1 (<1%)	0	1 (<1%)
Respiratory System	Amblyopia	1 (<1%)	0	1 (<1%)
Special Senses	Deafness	2 (2%)	0	2 (<1%)

Note: First reported stimulation-related AEs are defined as stimulation-related AEs that were reported during the first 3 months of VNS therapy and for which subject reported an AE that coded to that term during the first 3 months.

Note: AEs were coded using the COSTART 5 dictionary.

Note: Subjects were reported only once within each preferred term.

Note: Includes all AEs where relationship to stimulation was recorded as possible, probable, or definite.

**6.4.6-D. Duration of Stimulation-related Events**  
Subjects who reported adverse events during the first 3 months of stimulation and continued to be observed during the next 9 months were evaluated by 3-month intervals for continuation or resolution of their events. The largest decreases were noted between the first and second quarters of stimulation. The most notable exception was voice alteration. During the first quarter, 135 of 209 subjects (65%) reported voice alteration. Of those 135 subjects, 90 continued to report it during the fourth quarter of stimulation. See Table D-12.

**Table D-12. Duration of Early Stimulation-related Events Through 1 Year (Study D-02)**

Preferred Term	VNS Therapy (N=209)			
	N Reporting Event During First 3 Mos. <sup>1</sup>	3-6 Mos.	6-9 Mos.	9-12 Mos.
Voice Allergion	135	115 (85%)	101 (75%)	80 (67%)
Cough Increased	55	18 (33%)	15 (27%)	11 (20%)
Neck Pain	38	17(45%)	19 (50%)	16 (42%)
Dyspnea	35	22 (63%)	18 (51%)	16 (46%)
Dysphagia	31	16 (52%)	10 (32%)	6 (19%)
Paresthesia	26	12 (46%)	6 (23%)	4 (15%)
Laryngismus	23	13 (57%)	9 (39%)	5 (22%)
Pharyngitis	14	3 (21%)	2 (14%)	2 (14%)
Nausea	13	3 (23%)	1 (8%)	2 (15%)

<sup>1</sup>Entries are the number of subjects who experienced the AEs between implantation and 3 months.

<sup>2</sup>Number of subjects who continued to experience the same adverse event between months 3 and 6, months 6 and 9, and months 9 and 12.

Note: Subjects were counted only once within each preferred term and time interval.

**6.5-D. Severity of Adverse Events**

Investigators rated adverse events as mild, moderate, or severe according to the protocol definitions: mild events were transient and easily tolerated by the subject; moderate events caused discomfort and interrupted usual activities; severe events caused considerable interference with the subject's usual activities.

Most adverse events for the feasibility (D-01) study and pivotal (D-02) study were mild or moderate. Because the pivotal (D-02) study included a sham-control group, further analysis of severity rating was performed. After 3 months of treatment, there were 280 (43%) adverse events that were categorized as mild, 293 (45%) as moderate, and 73 (11%) as severe in the sham-control group. The active VNS Therapy group had 360 (47%) adverse events categorized as mild, 349 (45%) as moderate, and 61 (8%) as severe.

**6.6-D. VNS Therapy Continuation Rates**

Of the 295 subjects implanted during both the feasibility (D-01) and pivotal studies (D-02), 270 subjects (92%) were still receiving VNS Therapy at 12 months and 242 subjects (82%) were still receiving VNS Therapy at 24 months. This compares to 12- and 24-month continuation rates of 95% and 83%, respectively, for the subjects implanted in the epilepsy preapproval trials.

#### 6.7-D. Device Performance

The VNS Therapy System performed according to its specifications. Most device issues were communication difficulties resolved by repositioning the programming wand or replacing the programming wand batteries. One high lead impedance occurred requiring replacement; a lead break due to fatigue at the electrode bifurcation was noted. Most device complaints were resolved on the day of initial complaint.

#### 6.8-D. Analysis of Medical Device Reports Submitted to the FDA from July 1, 1997 through October 8, 2004 for the VNS Therapy System Epilepsy Indication

Once a medical device is approved for commercial distribution, the United States Food and Drug Administration (FDA) regulations require certain parties, including manufacturers of medical devices, to report to the FDA deaths and serious injuries to which a device has or may have caused or contributed. The required report is referred to as a medical device report (MDR). The FDA Office of Biometrics and Surveillance analyzed all MDRs submitted for the VNS Therapy System from July 1, 1997 through October 8, 2004. During this period, the VNS Therapy System had a single approved indication. By the end of the period analyzed, there were 2,453 of which were reported from sites within the United States. VNS Therapy device implants and 80,144 device-years of implant experience. It is important to emphasize that, although the events occurred during treatment with the

VNS Therapy System, the submission of an MDR does not necessarily mean the product caused or contributed to the event being reported.

#### 6.8.1-D. Deaths

A total of 524 deaths were reported to the FDA during the period from July 1, 1997 through October 8, 2004. By the end of the period, there were 32,065 VNS Therapy device implants and 80,144 device-years of implant experience. Of the 524 deaths, 102 (20%) were of an "unknown cause," including 24 deaths of unknown cause that occurred during sleep (5% of total deaths). Of those deaths with a reported cause, the following were the most common etiologies:

- seizure disorder (152 reports; 29% of total deaths), including sudden unexplained death in epilepsy and status epilepticus;
- respiratory events (99 reports; 19% of total deaths), including pneumonia, pulmonary edema, hypoxia;
- cardiac events (51 reports; 10% of total deaths), including cardiopulmonary arrest, infarction, and arrhythmias;
- neurovascular events (24 reports; 5% of total deaths), including stroke and cerebral hemorrhage
- malignancy (19 reports; 3% of total deaths), including brain and colon.
- Suicide (9 reports; 2% of total deaths)

### 6.8.2-D. Serious Injuries

A total of 1,644 serious injuries were reported to the FDA during the period from July 1, 1997 through October 8, 2004. By the end of the period, there were 32,065 VNS Therapy device implants and 80,144 device-years of implant experience. The most frequently reported serious injury was infection (525 reports). Approximately 40% of these were known to have required device explantation. The second most common serious injury reported was increased seizure activity (324 reports). Others included:

- vagus nerve injury (181 reports) including vocal cord paralysis (109) and hoarseness (71)
- respiratory injuries (141 reports) including sleep apnea (33), dyspnea (50), and aspiration (14)
- cardiac events (123 reports) including tachycardia, bradycardia, palpitations, hypertension, hypotension, syncope, and asystole
- pain (81 reports) including chest and neck pain;
- gastrointestinal events (60 reports) including dysphagia (24) and weight loss (24)
- depression (21 reports)

Of the 1,644 reports of serious injury, 694 (42%) were associated with subsequent device explantation in that subject.

### 6.8.3-D. Device Malfunctions

A total of 708 device malfunctions were reported to the FDA during the period from July 1, 1997 through October 8, 2004. By the end of the period, there were 32,065 VNS Therapy device implants and 80,144 device-years of implant experience. Some of the most common malfunctions reported were high lead impedance (351), lead breakage (116), device failure (44), and device migration (20).

## 7-D. CLINICAL STUDIES — EFFECTIVENESS

### 7.1-D. Feasibility (D-01) Study

The primary efficacy measure in the open-label feasibility (D-01) study was the percent of subjects responding (response was defined as a 50% or greater improvement in the HSRD<sub>24</sub> score). Of the 59 subjects with evaluable data, 18 (31%) responded at acute study exit, which was 12 weeks after implantation. Observation of subjects continued. After 1 year of adjunctive VNS Therapy, 25 of 55 subjects (45%) responded, and after 2 years, 18 of 42 (43%) responded. After 1 and 2 years of treatment, 27% and 21% of the subjects, respectively, were in remission (defined as HRS<sub>24</sub> scores less than or equal to 10). Other measures of depressive symptoms (CGI, MADRS, BDI, IDS-SR) and quality of life (MOS-36) supported the HRS<sub>24</sub> scores.

### 7.2-D. Pivotal (D-02) Study

The pivotal (D-02) study of VNS Therapy consisted of both an acute and a long-term phase to collect data regarding the safety and efficacy of VNS Therapy as an adjunctive treatment for persons with chronic or recurrent treatment-resistant depression.

#### 7.2.1-D. Pivotal D-02 Study, Acute Phase

The acute phase was a 12-week (after implantation), double-blind, randomized, parallel-group sham treatment-controlled, multi-center study. Subjects were assigned randomly to either the treatment (stimulation) group or control (sham) group and results of these two groups were compared. All subjects in both groups meeting the

eligibility criteria for participation in the study were implanted with the VNS Therapy Pulse Generator and VNS Therapy Lead. The VNS Therapy System remained OFF for 2 weeks after implantation to allow for recovery from surgery. Most subjects in the pivotal (D-02) study were being treated with one or more antidepressant medications at the time of enrollment. Medications were to remain constant at the pre-implant baseline dosages throughout the acute phase for both the treatment and sham-control groups.

**Sham Control:** Sham-control group subjects were treated the same as the treatment group, except that the output current of the device remained at 0.0 mA so that it did not deliver stimulation during the acute phase.

**Treatment Group:** Two weeks after implant, stimulation was initiated for the treatment group. Over the next 2 weeks, parameters were adjusted to subject tolerance, then remained constant for the rest of the acute phase (8 weeks). Decreases in stimulation parameters were permitted to accommodate subject tolerance.

### **7.3-D. Pivotal (D-02) Study, Long-term Phase**

All pivotal (D-02) study subjects who completed the acute phase were eligible to continue into the long-term extension phase, during which all subjects received active VNS Therapy. During the first 10 weeks of the extension phase, sham-control subjects (also referred to as the delayed treatment group for the long-term phase), received stimulation parameter adjustments. Weekly or every other week clinic visits and assessments were identical to those experienced by the treatment group during the acute phase. Otherwise, the protocol specified

monthly clinic visits for both groups through 12 months of active VNS Therapy. Various assessments, including depression ratings, were performed throughout this period. During the long-term extension phase, investigational site programmers were allowed to adjust stimulation parameters as clinically indicated.

Additionally, concomitant antidepressant treatments could be added, removed, or adjusted as clinically indicated.

### **7.3.1-D. Comparative Assessments**

Outcomes from a non-randomized comparative study (D-04) were compared with the long-term outcomes in study D-02. D-04 was a long-term, prospective, observational study to collect data regarding usual standard-of-care for treatment-resistant chronic or recurrent depression in persons who were experiencing a major depressive episode at the time of admission. Clinical (depression assessments) and quality of life outcomes were assessed at baseline, 3, 6, 9, and 12 months.

### **7.3.1.1-D. Concomitant Therapies**

Subjects enrolled in the comparative (D-04) study met the same enrollment criteria regarding chronicity or recurrence of depression, previous treatment failures, and severity of depression as subjects in the pivotal (D-02) study. Because the study was observational in nature, the protocol did not specify therapies for the treatment of depression; rather the physician managing the study subject's depression selected therapy according to clinical judgment. Thus antidepressant therapy in the comparative (D-04) study comprised "standard of care" treatment (also known as "treatment as usual"). The entire range of treatment options available for the comparative (D-04) study subjects was also available to the pivotal (D-02)

study subjects as concomitant treatment to their VNS Therapy. Thus subjects in both the long-term pivotal (D-02) extension and the comparative (D-04) study received standard-of-care treatment; however, only the pivotal (D-02) study subjects received VNS Therapy.

### 7.3.1.2-D. Comparison of D-02 and D-04 Study Populations

The comparative (D-04) study was conducted at 13 investigational sites, 12 of which were also pivotal (D-02) study sites. The similarities in the key inclusion criteria and study sites provide a basis to expect that the demographic and disease characteristics of both groups would be comparable, which was confirmed by the results of the analyses conducted to examine the comparability. The D-04 subjects provided a comparison group for the pivotal (D-02) study subjects at 12 months. See Table D-13.

Table D-13. Description of Subjects in Pivotal (D-02) and Comparative (D-04) Studies

Parameter	Statistic	D-02 (N=205)	D-04 (N=124)
Age (years)	Mean	46.3	45.5
Male	N (%)	74(36)	39(31)
Female	N (%)	131(64)	85(69)
Caucasian	N (%)	198(97)	111(90)*
African-American	N (%)	3(1)	5(4)
Hispanic	N (%)	3(1)	2(2)
Unipolar	N (%)	185(90)	109(88)
Bipolar	N (%)	20(10)	15(12)
Recurrent	N (%)	161(87)	93(65)
Single Episode	N (%)	24(13)	15(15)
Length of Current MDE (mos)	Mean	49.9(52.1)	68.6(91.5)
# Failed Trials in Current MDE	Mean (S.D.)	3.5(1.3)	3.5(1.3)
Received ECT	N (%)	108(53%)	32(26%)*
Received ECT - Current MDE	N (%)	72(35%)	15(12%)*
Duration of illness (yrs)	Mean (S.D.)	25.5(11.9)	25.6(13.2)
Lifetime episodes of Depression*			
0-2	N (%)	50(24)	31(25)
3-5	N (%)	69(34)	38(29)
6-10	N (%)	58(27)	18(15)
>10	N (%)	19(9)	32(26)
No Suicide Attempts in Lifetime	N (%)	140(68)	80(65)
Treatment induced (hypo)mania	N (%)	16(8)	6(5)
Hospitalizations for Depression	Mean (S.D.)	2.7(5.4)	2.1(2.9)
ECT Treatment Within past 2yrs	N (%)	54(26)	19(15)

\* p<0.05.



This comparison analyzed evaluable populations of 205 adjunctive VNS Therapy subjects (D-02) and 124 usual standard-of-care subjects (D-04). Groups were well matched, with similar demographic, psychiatric, and mood disorder treatment histories. The only relevant significant differences between groups were previous ECT history (with higher usage of ECT found in the D-02 group) and number of lifetime episodes of depression (with a higher percentage of the D-04 group reporting >10 lifetime episodes). These differences were handled within the efficacy analysis by use of a propensity adjustment.

#### **7.4-D. Data Analysis: D-02 and D-04 Studies**

##### **7.4.1-D. Pivotal (D-02) study**

The primary efficacy variable for both the acute and the long-term phases of the pivotal (D-02) study was the Hamilton Rating Scale for Depression-24 item (HRSD<sub>24</sub>). For the acute-phase analysis, the HRSD<sub>24</sub> response rate (percentage of subjects with a ≥50% improvement from baseline to 3 months, acute phase exit) was compared between the treatment and the sham-control groups. For the long-term phase, a linear regression model was used to assess the changes in HRSD<sub>24</sub> raw scores. Secondary efficacy analyses included within and between-group comparisons of 1) the Inventory of Depressive Symptomatology-Self Report (IDS-SR), 2) the Clinical Global Impressions (CGI), 3) the Montgomery-Asberg Depression Rating Scale (MADRS), and 4) the Medical Outcome Survey 36-Item Short Form Health Survey (MOS SF-36).

##### **7.4.2-D. Comparative (D-04) Study**

The primary efficacy variable for the D-02 and D-04 comparative analysis was the IDS-SR (raw scores). Multiple assessments with the IDS-SR allowed use of a linear regression model for the analysis. The HRSD<sub>24</sub> was used as a secondary assessment variable to analyze differences in response rates and raw score changes between subjects in the pivotal (D-02) and comparative (D-04) studies. Subjects in the comparative (D-04) study were assessed with the HRSD<sub>24</sub> only at baseline and 12 months.

Secondary analyses included IDS-SR average change, IDS-SR response, IDS-SR remission, IDS-SR sustained response, and HRSD<sub>24</sub> remission. Other secondary analyses included the CGI response.

##### **7.4.3-D. Propensity Scores**

Propensity scores were calculated for the pivotal (D-02) study and comparative (D-04) study groups and used in the linear regression analysis to address the potential impact of baseline differences on differences in outcome between the two groups. Propensity scores provide a scalar summary of the covariate information (e.g., age, number of prior depressive episodes, etc). They are not limited by the constraints of traditional methods of adjustment, which can only use a limited number of covariates for adjustment.

##### **7.4.4-D. Responder Rate**

Response was prospectively defined as a ≥50% improvement from baseline for the IDS-SR, HRSD<sub>24</sub>, and MADRS ratings and as a score of much or very much improved for the CGI improvement rating. Remission

(complete response) was prospectively defined as an HRSD<sub>16</sub> score of  $\leq 9$ , a MADRS score of  $\leq 10$ , or an IDS-SR score  $\leq 14$ .

All statistical analyses were performed using the updated SAS version 8.2. All statistical tests were two-sided and performed at the 0.050 level of significance. No adjustments were made for multiple outcome measures.

**Figure D-2. Pivotal Study, Long-Term**  
Flowchart: Pivotal Study, Long-term Phase

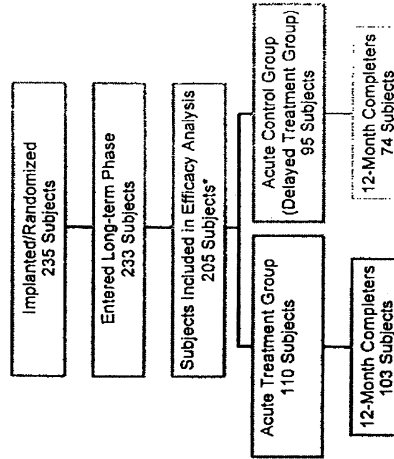

\*28 subjects did not qualify for Efficacy Analysis:  
21 sham-control subjects did not have required HRSD<sub>16</sub> score  $\geq 18$  at acute phase exit  
4 subjects did not have long-term phase efficacy assessments  
3 subjects did not meet continuation criteria for acute phase

**7.5-D. Results: Pivotal Study (D-02)**

Figure D-2 provides a flow chart of subjects from the acute phase through the long-term phase of the pivotal (D-02) study. Information describing subjects in the pivotal (D-02) and comparative (D-04) studies is presented in Table D-13.

**7.5.1-D. Results: Acute phase, pivotal (D-02) study**  
In the primary efficacy measure, HRSD<sub>16</sub> response rate, (the percentage of subjects achieving a  $\geq 50\%$  improvement in HRSD<sub>16</sub> total score from baseline to acute phase exit), 15% of the treatment group and 10% of the sham-control group were responders ( $p=0.238$ ). Analyses using a secondary efficacy parameter, the IDS-SR, did show a statistically significant advantage for VNS Therapy over sham treatment: 17% response versus 7% response ( $p=0.032$ ) using the last observation carried forward (LOCF) method.

**7.5.2-D. Results: Long-Term Phase, Pivotal Study (D-02)**

During long-term adjunctive VNS Therapy, the D-02 subjects exhibited statistically significant and clinically meaningful improvement. The primary analysis found statistically significant improvement from baseline in HRSD<sub>16</sub> scores averaged over 12 months ( $p<0.001$ ). Additionally, clinical significance was shown, using the HRSD<sub>16</sub>, IDS-SR, MADRS, and CGI (Figure D-3 and Figure D-4, evaluable population, and Table D-14, 12-month completer population).

Figure D-3. Responder Quarterly Results for D-02  
Evaluable Subjects

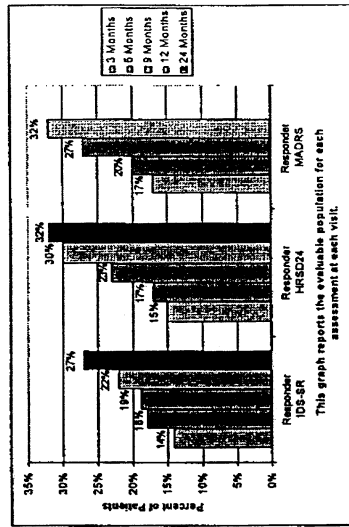

The number of evaluable subjects in each of the above analyses is as follows.

Mos	IDISSR	HRSD	MADRS
3	203	205	205
6	192	197	197
9	185	185	195
12	180	181	181
24	157	157	N/A

Figure D-4. Remitter Quarterly Results for D-02  
Evaluable Subjects

The number of evaluable subjects in each of the above analyses is as follows.

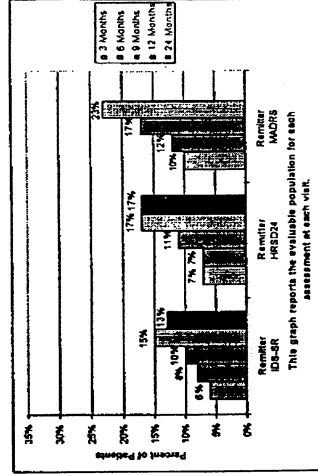

Mos	IDISSR	HRSD	MADRS
3	203	205	205
6	192	197	197
9	185	185	195
12	180	181	181
24	157	157	N/A

**Table D-14. Responders, Remitters, and Percent Change Pivotal (D-02) Study 12-Month Completer Population**

	HRSD <sub>17</sub> <sup>a</sup> 12-Month Visit	IDS-SR <sup>b</sup> 12-Month Visit	MADRS <sup>c</sup> 12-Month Visit
Responders – N (%)			
Treatment	34/103 (33%) <sup>d</sup>	25/102 (25%)	34/103 (33%) <sup>d</sup>
Delayed treatment	18/71 (25%)	13/71 (18%)	22/71 (31%) <sup>e</sup>
All 12-Month Completers	52/174 <sup>a</sup> (30%) <sup>d</sup>	38/173 (22%) <sup>f</sup>	56/174 (32%) <sup>d</sup>
Remitters – N (%)			
Treatment	19/103 (18%) <sup>d</sup>	16/102 (16%) <sup>f</sup>	25/103 (24%) <sup>f</sup>
Delayed treatment	10/71 (14%)	10/71 (14%)	16/71 (23%) <sup>f</sup>
All 12-Month Completers	29/174 (17%) <sup>d</sup>	26/173 (15%) <sup>f</sup>	41/174 (24%) <sup>f</sup>
Mean Percent Change from Baseline			
Treatment	31.9% <sup>g</sup>	27.8% <sup>g</sup>	32.9% <sup>g</sup>
Delayed treatment	26.5% <sup>g</sup>	17.3% <sup>g</sup>	26.3% <sup>g</sup>
All 12-Month Completers	29.7% <sup>g</sup>	23.5% <sup>g</sup>	30.2% <sup>g</sup>

<sup>a</sup> p<0.05; <sup>b</sup> p<0.01; <sup>c</sup> p<0.001; Response and Remitter used the Exact McNemar's test compared with 3 months; Percent Change used the paired t-test (change from pre-stimulation baseline).  
<sup>d</sup> These subjects did not have 12-month HRSD<sub>17</sub>, as assessments. (These 3 subjects did have 11-month assessments).  
<sup>e</sup> One subject did not have a baseline IDS-SR assessment and several others did not have 12-month assessments, which accounts for the varying Ns in the comparison of HRSD<sub>17</sub> with IDS-SR data.  
<sup>f</sup> Two delayed-treatment subjects did not have 12-month MADRS assessments.

**7.5.3-D. Quality of Life Assessment**  
 The observed improvement in depression among subjects in the pivotal (D-02) study long-term phase was supported by improved quality of life as measured by the MOS SF-36. Significant improvement was observed in several of the MOS SF-36 subscales: Vitality, Social Functioning, Role Functioning – Emotional, Mental Health (p<0.01), and the Physical and General Health Perceptions (p<0.05).

**7.6-D. Results: Comparison of D-02 and D-04 Studies**

The D-04 study provided a control group of similarly ill subjects who received usual standard-of-care therapies for 12 months but were not implanted with the VNS Therapy device. See Table D-13.

**7.6.1-D. Primary Effectiveness Outcome**  
 The primary and secondary analyses comparing subjects treated with VNS Therapy plus usual standard-of-care (pivotal, D-02) with subjects treated with usual standard-of-care alone (comparative, D-04) showed that adjunctive VNS Therapy produced statistically significantly greater improvement in depressive symptoms over 1 year of treatment. The primary efficacy analysis, a repeated measures linear regression analysis of the IDS-SR over 1 year, showed a statistically significant (p<0.001) evaluable; p<0.001 intent to treat) difference favoring adjunctive VNS Therapy. (See Figure D-5.)

Figure D-5. Comparison of IDS-SR Scores of Pivotal (D-02) Versus Comparative (D-04) Study Subjects by Quarter (Repeated Measures Linear Regression Analysis), Evaluable Population

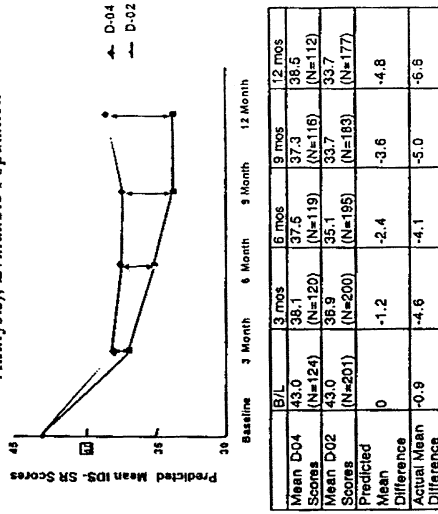

### 7.6.2-D. Secondary Analyses

Additionally, the following secondary analyses were statistically significant and showed adjunctive VNS Therapy improved depressive symptoms more than usual standard-of-care alone after 12 months of therapy. See Figure D-6 and Figure D-7.

Figure D-6. Secondary Analyses: Categorical Outcomes at 12 Months (Evaluable Observed Analysis)

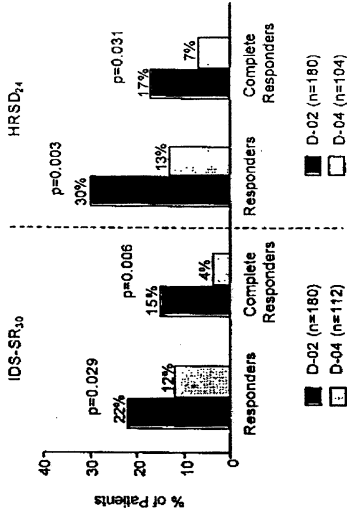
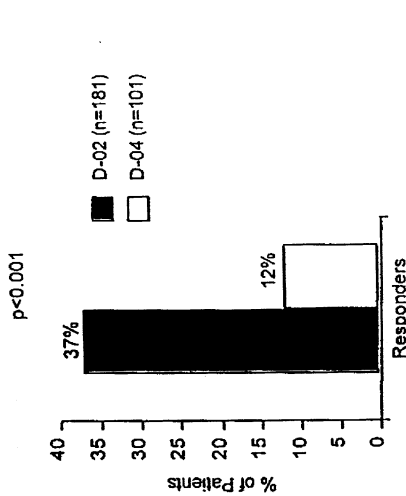
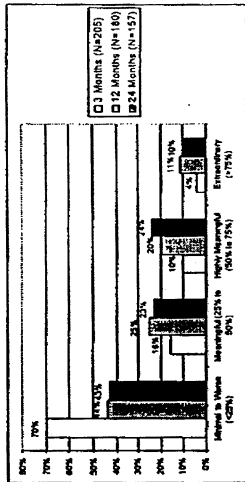

Figure D-7. Secondary Analyses: CGI-I Categorical Outcome at 12 Months (Evaluable Observed Analysis)



As shown in Figure D-8, clinical benefit increased over time. The percent of subjects realizing at least a meaningful clinical benefit at 12 months was significant when compared to those experiencing a similar benefit after 3 months (Stuart-Maxwell test,  $p < 0.001$ ).

Figure D-8. Clinical Benefit after 3, 12 and 24 months; D-02 Evaluable Population; HRS<sub>D4</sub>



The subjects realizing at least a meaningful clinical benefit after 12 months of adjunctive VNS Therapy included subjects who sustained their 3-month meaningful or greater benefit and those who had minimal to no 3-month benefit and accrued at least a meaningful benefit after 12 months. Of the 56 subjects who had at least a meaningful benefit at 3 months, 41 (73%) continued to have at least a meaningful benefit at 12 months and 34 (61%) of these same 56 subjects had at least the same level of clinical benefit after 12 months of adjunctive VNS Therapy as they did after 3 months. Of the 118 subjects who realized minimal-to-worse clinical benefit after 3 months of adjunctive VNS Therapy, 56 (47%) had

### 7.7-D. Clinical Benefit Over Time

To explore whether these subjects were receiving benefit that was not fully reflected in the response rates, they were assigned to categories according to "clinical benefit." Clinical benefit was prospectively defined as extraordinary ( $\geq 75\%$  improvement in HRS<sub>D4</sub>), highly meaningful (50% to  $< 75\%$ ), meaningful (25% to  $< 50\%$ ), minimal (0% to  $< 25\%$ ), and worsened (less than 0%). This scale is consistent with studies in many chronic illnesses that define less than a 50% improvement as a clinically meaningful response (e.g., schizophrenia, obsessive compulsive disorder).

at least a meaningful benefit after 12 months of adjunctive VNS Therapy.

A majority (56%) of evaluable subjects treated with adjunctive VNS Therapy realized at least a meaningful clinical benefit after 12 months of treatment. After 24 months of VNS Therapy, 57% of evaluable subjects realized at least a meaningful clinical benefit.

**7.8-D. Maintaining Response (2 Year Data)**

An analysis of subjects having an initial  $\geq 50\%$  reduction in HRSD score at the designated "early" visit (3 months or 12 months) and then maintaining at least a  $\geq 40\%$  reduction at the later visit (1 or 2 years), was performed for the D-02 Study. Data are presented below in a bar graph (Figure D-9), with each bar showing the percent of subjects that maintained their early response at the later observation.

**Figure D-9. Maintenance of Adjunctive VNS Therapy Response (% of HRSD Responders who Maintained Response at 1 and 2 Years)**

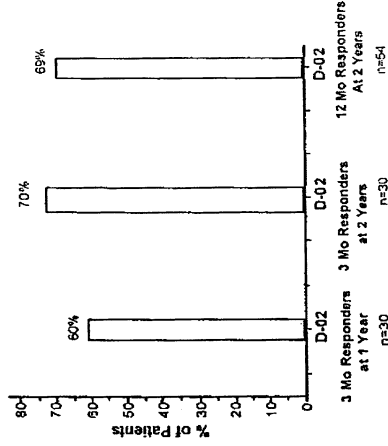

When IDS data were used instead of HRSD data, similar results were observed (61% of 3-month responders were also responders at 12 months, 57% of 3-month responders were also responders at 24 months, and 85% of 12-month responders were also responders at 24 months). By contrast, no D-04 3-month responder maintained that response at the 12-month observation.

### 7.9-D. *Standard-of-Care Antidepressant Treatments During the Long-term Phase of Study D-02 and During Study D-04*

#### 7.9.1-D. *Electroconvulsive Therapy*

Electroconvulsive therapy (ECT) use was similar among the pivotal (D-02) and comparative (D-04) study subjects (7% and 6%, respectively) during the first year of observation.

#### 7.9.2-D. *Antidepressant Drugs and Response*

Antidepressant drug use was significantly greater among pivotal (D-02) study subjects who were non-responders and comparative (D-04) study subjects overall than among the pivotal (D-02) study subjects who achieved a response ( $p < 0.001$ ). During the 12 months, 77% of the pivotal (D-02) study non-responders and 81% of all comparative (D-04) study subjects either added a new antidepressant treatment or increased an existing antidepressant dose by an antidepressant resistance rating (ARR) level of one or more. By contrast, only 56% of the pivotal (D-02) study subjects who were responders to VNS Therapy either added a new antidepressant treatment or increased an existing antidepressant dose by an antidepressant resistance rating (ARR) level of one or more.

For the evaluable group at 12-months, 61 subjects were responders while 144 subjects were non-responders (N=205). On a percentage basis twice as many pivotal (D-02) study responders had no ARR changes or removed or decreased medications by at least one ARR level or were

not taking medications as compared to the non-responders (44% versus 23%, respectively).

#### 7.9.3-D. *Medication Censoring Analyses*

Additional medication censoring analyses were performed using the D-02 and the D-02 versus D-04 repeated measures linear regression methods to evaluate further the potential effect of medication changes. This censoring approach used a missing data paradigm to calculate the D-02 results that would have been observed under conditions where no intercurrent changes in medications would have occurred in the D-02 group. The approach censors the D-02 IDS-SR scores after the point at which a subject had a significant medication increase (ARR increase) or ECT treatment, and the last pre-censored score is carried forward and used for subsequent assessment periods. The censoring had the effect of truncating the VNS treatment benefit from 12 months to an average of 7 months. In the D-02 censored analysis, the average HRSD<sub>14</sub> change from baseline was  $-0.25$  points per month in the repeated measures linear regression ( $p < 0.001$ ).

The D-02 censored versus D-04 IDS-SR repeated measures linear regression comparison was an asymmetric comparison of the VNS group treated for 7 months with VNS plus no changes from baseline treatments versus the D-04 group treated for a full 12 months with unlimited standard-of-care treatments (no censoring was performed on the D-04 data). The results of the censoring analysis approached but did not reach statistical significance in the comparison of the D-02 group with the D-04 group ( $p = 0.052$ ; 95% CI  $-0.37$ ,  $0.00$ ) for the evaluable population.



### 7.10-D. Bibliography

A bibliography of animal, clinical, and mechanism of action studies is available from Cyberonics on request.

### 8-D. INDIVIDUALIZATION OF TREATMENT

Patients should be started on stimulation at a low current output setting (0.25 mA), and the current should be increased gradually to allow accommodation to the stimulation. For patient comfort, the output current should be increased in 0.25 mA increments until a comfortable tolerance level is reached. Physicians should appreciate that some patients will accommodate to stimulation levels over time and should therefore allow further increases (in 0.25 mA steps) in output current, if needed. (See the Model 250 VNS Therapy Software Physician's Manual.) Table D-15 lists the stimulation parameters reported at 12 months of VNS Therapy in the pivotal (D-02) study.

Table D-15. Stimulation Parameters at 12 months of VNS Therapy in the Pivotal (D-02) Study

Stimulation Parameters	Median Value at 12 months	Range
Output current	1.0	0 to 2.25
Frequency	20 Hz	2 to 30 Hz
Pulse width	500 $\mu$ sec	130 to 750 $\mu$ sec
ON time	30 sec	7 to 60 sec
OFF time	5 min	0.3 to 180 min

The magnet output current should be set to 0 mA.

#### **9-D. PATIENT COUNSELING INFORMATION**

In the event of uncomfortable adverse events, continuous stimulation, or other malfunction, the patient must be advised to hold or tape the magnet directly over the implanted Pulse Generator to prevent additional stimulation. If patients or caregivers find this procedure necessary, they should immediately notify the patient's physician.

#### **10-D. CONFORMANCE TO STANDARDS**

The VNS Therapy System conforms to the following standards:

- ◆ American National Standards Institute (ANSI) and Association for the Advancement of Medical Instrumentation (AAMI) NS15 — Implantable, peripheral nerve stimulators
- ◆ EN 45502-1 — Active Implantable Medical Devices: Requirements for the safety, marking, and information to be provided by the manufacturer

# Depression Patient's Manual

For Vagus Nerve Stimulation  
with the VNS Therapy™ System

June 2005

This Patient's Manual is a supplement to the physician's manuals. It is not meant to take the place of advice from your doctor. For a complete discussion of indications for use, contraindications, precautions, warnings, and potential side effects, please talk to your doctor.

Please talk with your doctor about

- ◆ how this device is used
- ◆ how it should not be used
- ◆ safety measures
- ◆ warnings
- ◆ side effects

Your doctor's phone number:

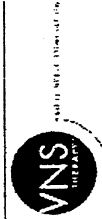

REF 26-0005-6000/4  
© Copyright 2005 Cyberonics, Inc. Houston, Texas  
All rights reserved

## Table of Contents

1. INTRODUCTION TO VNS THERAPY .....	1
2. THE VNS THERAPY SYSTEM .....	2
2.1. Parts of the VNS Therapy System .....	2
3. QUICK REFERENCE GUIDE .....	6
4. WHO USES VNS THERAPY? .....	8
4.1. Indications for Use .....	8
4.2. Contraindications (When VNS Therapy Should Not Be Used) .....	8
5. WARNINGS AND PRECAUTIONS .....	10
5.1. Warnings .....	10
5.2. Precautions .....	13
5.3. Environmental Hazards .....	13
5.4. Medical Hazards .....	15
5.5. Interference with Other Devices .....	17
6. SIDE EFFECT AND SAFETY PROFILE OF VNS THERAPY OBSERVED IN CLINICAL STUDIES IN DEPRESSED PATIENTS .....	18
6.1. Overview of Clinical Studies .....	18
6.2. Surgical Implantation Procedure .....	19
6.3. Stimulation of the Vagus Nerve .....	21
6.4. Additional Safety Considerations .....	23
6.5. Analysis of Medical Device Reports Submitted to FDA from July 1, 1997 through October 8, 2004 for the VNS Therapy System Epilepsy Indication .....	26
7. BENEFITS OF VNS THERAPY .....	30
7.1. Effectiveness Results From the D-02 Clinical Study .....	30
7.2. Quality of Life Measurements in the D-02 Clinical Study .....	34

Patient/Depression-I

7.3. Expected Rate of Response to VNS Therapy .....	34
7.4. Treatment Continuation Rates .....	34
7.5. Limitations of VNS Therapy .....	34
8. HAVING THE DEVICE IMPLANTED .....	35
8.1. Surgery (Operation) .....	35
8.2. Follow-up After Surgery .....	36
8.3. Antidepressant Medications .....	37
9. THE CYBERONICS MAGNETS .....	38
9.1. Handling the Cyberonics Magnets .....	38
9.2. Using Your Cyberonics Magnets .....	39
9.3. How the Magnets Work .....	41
9.4. Replacing the Cyberonics Magnets .....	43
10. OTHER IMPORTANT INFORMATION ABOUT YOUR VNS THERAPY SYSTEM .....	44
10.1. Device Complications .....	44
11. CYBERONICS' PATIENT WARRANTY AND SAFETY LISTING .....	47
12. FREQUENTLY ASKED QUESTIONS .....	48

## **Tables**

<b>Table 1.</b> Stimulation-Related Side Effects Reported by Greater Than or Equal To 3% of Patients—Study D-02 .....	22
<b>Table 2.</b> Percent of Responders and Remitters After VNS Therapy .....	31

## **Figures**

<b>Figure 1.</b> Implantable parts of the VNS Therapy System ..	2
<b>Figure 2.</b> Nonimplantable parts of the VNS Therapy System .....	3
<b>Figure 3.</b> Categories of Clinical Benefit After 12 Months of VNS Therapy (HRSD <sub>16</sub> ) .....	33
<b>Figure 4.</b> The Cyberonics Magnets .....	38
<b>Figure 5.</b> Stopping Stimulation .....	40
<b>Figure 6.</b> Reed Switch Position .....	42

## **Useful Terms**

These terms are used in this manual.

**Adjunctive Therapy** — Additional, add-on; VNS is adjunctive therapy, it is added on to other antidepressant treatments

**Adverse events** — Complications and side effects

**Clinical benefit** — Categories assigned to describe change in depressive symptoms on Hamilton Rating Scale for Depression-24 Item after VNS Therapy

**Meaningful clinical benefit** – 25% to 49% improvement in depressive symptoms

**Highly meaningful clinical benefit** – 50% to 74% improvement in depressive symptoms

**Extraordinary clinical benefit** – over 75% improvement in depressive symptoms

**Clinical studies** — Tests of the effectiveness and safety of a therapy on humans

**Cyberonics** — Company that makes the VNS Therapy System

**Electrodes** — Part of the VNS Therapy Lead that connects to the vagus nerve

**HSRD<sub>24</sub>** — Standardized test to measure depressive symptoms as reported by the doctor; Hamilton Rating Scale for Depression-24 Item

**ISD-SR** — Standardized test to measure depressive symptoms as reported by the patient, Inventory of Depressive Symptomatology Self-Report

**Lead** — VNS Therapy Lead; small wire that connects the VNS Therapy Pulse Generator to the vagus nerve

**MADRS** — Standardized test to measure depressive symptoms as reported by the doctor, Montgomery-Asberg Depression Rating Scale; commonly used in Europe

**Programming Wand** — VNS Therapy instrument used to check or change VNS Therapy device and settings

**Pulse Generator** — VNS Therapy device implanted in the patient's chest; holds the battery and delivers stimulation to the vagus nerve through the VNS Therapy Lead

**Reed Switch** — This mechanism works like a gate. When the Magnet closes it, the signal (stimulation) cannot pass. The Pulse Generator is temporarily turned OFF.

**Remitter** — Study participant who was essentially free of depressive symptoms after receiving VNS Therapy; determined by scores of standardized tests; also called complete responder

**Responder** — Study participant whose depressive symptoms were reduced by 50% or more after receiving VNS Therapy; determined by scores of standardized tests

**Stimulate** — Send electrical signal; with VNS Therapy, the Pulse Generator sends an electrical signal through the Lead to the vagus nerve, which carries the signal to the brain

**Stimulation** — The electrical signal that is sent from the Pulse Generator to the brain

**Treatment-resistant Depression (TRD)** — Depression that has not responded to four or more antidepressant treatments

**Vagus nerve** — A nerve that extends from the brain through the neck to the major organs (heart, lungs, stomach, etc.) in the torso

**Vagus Nerve Stimulation** — (VNS) periodic electrical signals sent from the Pulse Generator to the vagus nerve

**VNS Therapy** — Treatment received from vagus nerve stimulation

**VNS Therapy System** — All of the parts that provide VNS Therapy: Pulse Generator, Lead, Programming Wand, Computer, Software, and Magnets

## 1. INTRODUCTION TO VNS THERAPY

Many people have depression. Through the years, doctors and scientists have learned much about depression. They have developed drugs and other treatments. Despite these efforts, some people still have depression. Your doctor has proposed the VNS Therapy™ System for you to reduce the symptoms of your depression because drugs have failed to control them adequately.

The VNS Therapy System sends a mild electrical impulse to a nerve that goes to the brain. This nerve is called the vagus nerve. The treatment is Vagus Nerve Stimulation (VNS) Therapy (VNS Therapy™).

**2. THE VNS THERAPY SYSTEM**

**2.1. Parts of the VNS Therapy System**

The VNS System has several implantable and nonimplantable parts (see Figure 1 and Figure 2).

**2.1.1. Implantable parts**

- ♦ VNS Therapy Pulse Generator
- ♦ VNS Therapy Lead

Figure 1. Implantable parts of the VNS Therapy System

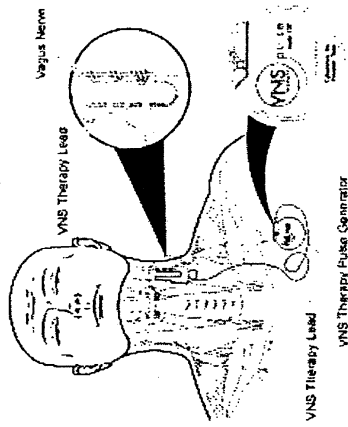

**2.1.2. Nonimplantable parts**

- ♦ VNS Therapy Computer
- ♦ VNS Therapy Programming Software
- ♦ VNS Therapy Programming Wand
- ♦ VNS Therapy Magnets

Figure 2. Nonimplantable parts of the VNS Therapy System

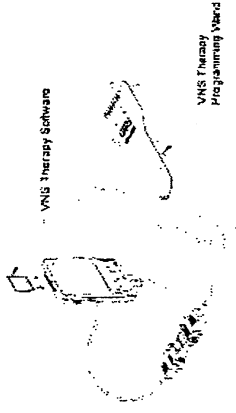

**2.1.3. Pulse Generator**

The main part is the Pulse Generator, sometimes called a stimulator. Similar to cardiac pacemakers, which have been used since 1958 to control heart problems, the Pulse Generator is computer controlled and battery powered. It sends signals through the electrodes of the Lead to the brain by way of the left vagus nerve.

#### **2.1.4. Placement of the Pulse Generator and Lead**

The Pulse Generator is placed under the skin of the upper chest. The Lead connects the Pulse Generator to the vagus nerve. It is surgically attached to the left vagus nerve in the neck. A surgeon implants the Pulse Generator and Lead during an operation that typically lasts about 1 to 2 hours. Later, your doctor sets the Pulse Generator to deliver periodic stimulation 24 hours a day (for example, 30 minutes ON and 5 minutes OFF). At the office, your doctor can read and change stimulation settings with the Computer, Software, and Programming Wand.

#### **2.1.5. Cyberonics Magnet**

Cyberonics provides a Magnet for you to stop stimulation if and when you need to (see the "Using Your Cyberonics Magnets" section of this manual).

#### **2.1.6. Stimulation settings**

The Pulse Generator has many settings. Your doctor will choose the settings. He or she can change (reprogram) the periodic stimulation at any time with the Programming Wand, Software, and Computer. Most of the time, changing the VNS Therapy System settings is a painless procedure, takes only a few minutes, and can be done in the doctor's office.

#### **2.1.7. Pulse Generator life**

The battery in the Pulse Generator can last from 1 to 16 years.

The lifespan depends on these factors:

- ◆ Pulse Generator model

Patient/Depression-4

- ◆ Settings your doctor chooses

- ◆ Interaction of the Lead and vagus nerve over time

When the battery in your Pulse Generator runs out, the Pulse Generator must be replaced in order for you to continue to receive VNS Therapy. This requires an additional surgical procedure. The operation involves anesthesia and generally takes less than an hour to complete. Please refer to the "Battery depletion (running out)" section of this manual for additional information about battery depletion.



### 3. QUICK REFERENCE GUIDE

This quick guide provides important information about the VNS Therapy System. It will be most useful after you have read the whole manual. A list of frequently asked questions is included at the end of this manual.

When you see this symbol , pay special attention to the important information after it.

After you receive your VNS Therapy System, keep this important information in mind.

- ◆ You should not receive a VNS Therapy System implant if your left vagus nerve has previously been cut.
- ◆ You CANNOT have any short-wave diathermy, microwave diathermy, or therapeutic ultrasound diathermy anywhere on your body if you have an implanted VNS Therapy System.
- ◆ Use the **Cyberonics Magnet to stop the stimulation** if it becomes painful or irregular (see the “Using Your Cyberonics Magnets” section of this manual).
- ◆ **Call your doctor right away** if any of the following occur:
  - ◆ Your voice is constantly hoarse.
  - ◆ Stimulation becomes painful or irregular.
  - ◆ Stimulation causes any choking, trouble with breathing, trouble with swallowing, or change in heart rate.
  - ◆ You or someone else notices changes in your level of consciousness (for example, you become constantly drowsy).

- ◆ You think that the Pulse Generator may not be stimulating properly or that the VNS Therapy System battery is depleted (stops stimulating).
  - ◆ You notice anything new or unusual that you relate to the stimulation.
  - ◆ The feeling that you usually have during stimulation becomes stronger or weaker (see the “Complications” section of this manual).
  - ◆ Your depressive symptoms increase or suicidality (suicidal thoughts or behavior) increases. See the “Additional Safety Considerations” section of this manual for details.
  - ◆ Call your doctor before you have any medical tests that might affect, or be affected by, the VNS Therapy System, such as magnetic resonance imaging (MRI) scans (see the “Medical Hazards” section of this manual).
  - ◆ Call your doctor before you have any other medical devices implanted (see the “Medical Hazards” section of this manual).
  - ◆ Tell your doctor at your next visit if you no longer feel the routine stimulation. Your doctor may decide to change your settings.
- Cyberonics *cannot* provide health care advice or services. Your source for health questions must always be your doctor.

## 4. WHO USES VNS THERAPY?

VNS Therapy has been approved for people with chronic or recurrent treatment resistant depression who have failed to respond to four or more adequate treatments. It is *not* right for everyone who has depression. You and your doctor will decide if VNS Therapy is right for you. Your doctor will also decide if you have any other medical conditions that might be affected by VNS Therapy.

### 4.1. Indications for Use

The VNS Therapy System is indicated for the adjunctive long-term treatment of chronic or recurrent depression for patients 18 years of age or older who are experiencing a major depressive episode and have not had an adequate response to four or more adequate antidepressant treatments.

### 4.2. Contraindications (When VNS Therapy Should Not Be Used)

**⚠️ CONTRAINDICATION:** The VNS Therapy System should not be used (is contraindicated) in people who have had the left vagus nerve cut to treat another disorder (a left vagotomy).

**⚠️ CONTRAINDICATION:** Inform anyone treating you that you CANNOT have any short-wave diathermy, microwave diathermy, or therapeutic ultrasound diathermy (hereafter referred to as “diathermy”) anywhere on your body because you have an implanted VNS Therapy System (sometimes referred to as a “Vagus Nerve Stimulator” or “Vagus Nerve

Stimulation”). Diagnostic ultrasound is not included in this contraindication.

Diathermy is a treatment to promote healing or relieve pain. It is provided by special medical equipment (diathermy equipment) in a doctor’s office, dentist’s office, or other healthcare setting.

Energy from diathermy therapy may cause heating of the VNS Therapy System. The heating of the VNS Therapy System resulting from diathermy can cause temporary or permanent nerve or tissue or vascular damage. This damage may result in pain or discomfort, loss of vocal cord function, or even possibly death if there is damage to blood vessels.

Diathermy may also damage parts of your VNS Therapy System. This damage can result in loss of therapy from your VNS Therapy System. More surgery may be required to remove or replace parts of your implanted device.

Injury or damage can occur during diathermy treatment whether your VNS Therapy System is turned “ON” or “OFF.”

## 5. WARNINGS AND PRECAUTIONS

As with all types of treatment for depression, VNS Therapy carries some risks. Talk to your physician about other risks not covered in this manual that you should know about. Also be sure to ask any questions that you have about any of the following warnings, precautions, side effects, and possible hazards.

### 5.1. Warnings

#### Worsening Depression/Suicidality

You will need to be observed closely for clinical worsening and suicidality (suicidal thoughts or behavior), especially at the time of drug or drug dose changes, or VNS Therapy stimulation parameter changes.

#### Unapproved uses

The safety and efficacy of the VNS Therapy System have not been established for uses outside its approved indications for use. The safety and efficacy of VNS Therapy have *not* been shown for people with these conditions:

- ♦ Acute suicidal thinking or behavior
- ♦ History of schizophrenia, schizoaffective disorder or delusional disorders
- ♦ History of rapid cycling bipolar disorder
- ♦ History of previous therapeutic brain surgery or brain injury
- ♦ Progressive neurological diseases other than epilepsy

- ♦ Heart arrhythmias (irregular heart beats) or other heart abnormalities
- ♦ History of dysautonomias
- ♦ History of lung diseases or disorders, including shortness of breath and asthma
- ♦ History of ulcers (gastric, duodenal, or other)
- ♦ History of vasovagal syncope (fainting)
- ♦ Only one vagus nerve
- ♦ Other concurrent forms of brain stimulation
- ♦ Preexisting hoarseness

#### Swallowing difficulties

Difficulty swallowing may occur with active stimulation, and aspiration may result from the increased swallowing difficulties.

#### Shortness of breath

Shortness of breath may occur with active VNS Therapy, especially if you have chronic obstructive pulmonary disease or asthma.

#### Obstructive sleep apnea

Use of the VNS Therapy device can cause or worsen pre-existing obstructive sleep apnea (episodes where breathing stops for short periods of time while sleeping).

#### Device malfunction

Device malfunction could cause painful stimulation or direct

current stimulation. Either event could cause nerve damage and other associated problems.

**⚠ Magnetic resonance imaging (MRI)**

You should not have a full body MRI while the VNS Therapy device is in place. Additional surgery may be required to remove the system if full body MRI is required. You should contact your physician before undergoing MRI.

**⚠ Device removal**

Device removal requires an additional surgical procedure. When removing a device, the surgeon may leave part of the Lead behind. This may pose certain risks (see the “Medical Hazards” section in this manual).

**⚠ Device manipulation**

Do not manipulate the Pulse Generator and Lead through the skin as this may damage or disconnect the Lead from the Pulse Generator and/or possibly cause damage to the vagus nerve.

## 5.2. Precautions

**⚠ Use during pregnancy**

The safety and effectiveness of the VNS Therapy System have not been established for use during pregnancy.

**⚠ Laryngeal irritation may result from stimulation.** Patients who smoke may have an increased risk of laryngeal irritation.

## 5.3. Environmental Hazards

Being close to certain types of equipment can affect the Pulse Generator. Move away from or avoid equipment such as transmitting antennas.

### 5.3.1. Pacemaker Warning signs

Talk to your doctor before going into places with Pacemaker Warning signs.

### 5.3.2. Small appliances

Properly operating microwave ovens and other small electrical appliances, such as toasters, hair dryers, and electric shavers, should *not* affect the Pulse Generator.

### 5.3.3. Cellular phones

Cellular phones can affect some implanted cardiac defibrillators and pacemakers. But tests to date show that they do *not* affect the Pulse Generator.

### 5.3.4. Transmitting devices

Properly operating electrical ignition systems and power transmission lines should *not* affect the Pulse Generator. Sources with high energy levels, such as transmitting antennas, *may* interfere with the device. Move at least 2 meters (6 feet) away from any equipment that interferes with your device.

### 5.3.5. Antitheft devices, airport security systems, and other metal detectors

Antitheft devices and metal detectors should *not* affect the Pulse Generator or be affected by it. As a precaution, however, move through them at a steady pace; do not linger in the area.

### 5.3.6. Devices with strong electromagnetic fields

Electrical or electromechanical devices with a strong static or pulsing magnetic field can cause the Pulse Generator to start suddenly. Such devices may include strong magnets, hair clippers, vibrators, and loudspeakers. Keep this type of equipment at least 15 centimeters (6 inches) away from your chest.

If your Pulse Generator stops while you are in a strong electromagnetic field, move away from the source so that the device may return to regular operation.

### 5.4. Medical Hazards

Medical equipment, procedures, and surgery using certain electrical instruments can affect the VNS Therapy System's operation and sometimes damage the Pulse Generator or Lead.

 Make sure that medical personnel know you have a device implanted in your chest.

 Always call your doctor before you have any medical tests that may affect, or be affected by, the VNS Therapy System as described below. Precautions may be needed.

#### 5.4.1. Routine diagnostic procedures

Most routine diagnostic procedures, such as diagnostic ultrasound and radiography (x-rays), should *not* affect the VNS Therapy System.

#### 5.4.2. Mammography

Because the Pulse Generator is in your chest, you may need to be specially positioned for a mammogram. Otherwise, the device may be seen as a shadow on the mammogram. It could make a lesion or lump in that area hard or even impossible to detect. Make sure that your doctor and the mammography technician are aware of the implanted device.

### 5.4.3. Radiation treatment

Treatment with radiation, cobalt machines, and linear accelerators *may* damage the Pulse Generator. Note that no testing has been done to date. The effect of radiation on the device is not known. Talk with your doctor if you plan to have radiation treatment.

### 5.4.4. Magnetic resonance imaging

If you plan to have magnetic resonance imaging (MRI), make sure your doctor has the following information.

 Magnetic resonance imaging (MRI) should not be performed with a magnetic resonance body coil in the Transmit Mode. The heat induced in the Lead by an MRI body scan can cause injury.

MRI using the whole body coil is not recommended because it can damage the vagus nerve. Contact your physician before having any MRI performed so that it can be discussed with the MRI personnel.

### 5.4.5. Other procedures

External cardiac defibrillation and other procedures for heart problems, as well as extracorporeal shockwave lithotripsy, diathermy, and electrocautery, *may damage* the Pulse Generator. If you had any of these procedures and your doctor did not know about it, have the Pulse Generator checked.

While *diagnostic* ultrasound should *not* affect the VNS Therapy System, *therapeutic* ultrasound therapy *could* damage the Pulse Generator or inadvertently harm you.

### 5.5. Interference with Other Devices

While the Pulse Generator is stimulating or being set or tested, it may briefly interfere with nearby equipment. If this happens, move at least 2 meters (6 feet) away from such equipment.

#### 5.5.1. Radios and hearing aids

The Pulse Generator can interfere with devices operating in the 40 kHz to 100 kHz range. Hearing aids and transistor radios operate in this range. In theory, the Pulse Generator could affect them, but no effects have yet been reported. No detailed testing has been done, so the effects are unknown.

#### 5.5.2. Implanted devices

The Pulse Generator may affect other implanted medical devices, such as cardiac pacemakers and implantable defibrillators. Possible effects include sensing problems. These could lead to inappropriate responses from the Pulse Generator.

#### 5.5.3. Credit cards and computer discs

The VNS Therapy Magnets are very strong. They *can* damage televisions, computer disks, credit cards, and other items that are affected by strong magnetic fields. Keep your Magnet at least 25 centimeters (10 inches) away from any of these items. **Do not** carry or store the Magnets near them.

## 6. SIDE EFFECT AND SAFETY PROFILE OF VNS THERAPY OBSERVED IN CLINICAL STUDIES IN DEPRESSED PATIENTS

This section describes the side effects and safety concerns that were observed in the clinical studies that led to the approval of VNS Therapy as an treatment for patients with treatment-resistant depression. The side effects and safety concerns associated both with the surgical implantation procedure for the VNS Therapy System and those related to stimulation of the vagus nerve arc discussed. In addition, this section discusses some specific safety considerations for the treatment of patients with depression.

### 6.1. Overview of Clinical Studies

Safety and effectiveness studies involved a total of 295 men and women who received VNS Therapy along with their usual antidepressant treatments. Sixty of them participated in a pilot study that compared depressive symptoms before and after VNS Therapy. The favorable results from that study prompted a second study. The second study (sometimes referred to as “D-02”) consisted of two “phases” and included people with treatment-resistant depression. In the first phase, which lasted 3 months, half of the 235 patients who were implanted with the device had it turned on while the other half did not. Patients did not know whether the device was on or not. In the second phase of the study (referred to as the “long-term phase of D-02”), all patients had the device turned on after the first 3 months and were followed for at least a full year. Patients in the long-term phase of the study were allowed to have adjustments in the doses of depression medications prescribed and were also allowed to have new medications or ECT prescribed during this time. These

Patient/Depression-18

patients were compared to a separate group of 124 people with treatment resistant depression who received antidepressant treatments, but who did not have the device implanted.

### 6.2. Surgical Implantation Procedure

#### 6.2.1. Side effects that may occur from implantation of the VNS Therapy System

The following is a list of the side effects that were most commonly reported as being related to the surgical implantation of the VNS Therapy System during the D-02 study. The side effects that occurred in at least 3% of the patients in the D-02 study, and the percentage of patients who experienced them were as follows:

- ◆ Incision pain (36%)
- ◆ Voice alteration (33%)
- ◆ Incision site reaction (for example, redness, itching, soreness) (29%)
- ◆ Pain around the device generator or leads (23%)
- ◆ Other reactions around the device generator or leads (for example, swelling, tenderness) (14%)
- ◆ Pharyngitis (inflammation of the throat) (13%)
- ◆ Difficulty swallowing (11%)
- ◆ Numbness (11%)
- ◆ Nausea (9%)

Patient/Depression-19

- ◆ Shortness of breath (9%)
- ◆ Headache (8%)
- ◆ Neck pain (7%)
- ◆ Pain elsewhere (7%)
- ◆ Increased cough (6%)
- ◆ Paresthesia (tingling sensation) (6%)
- ◆ Infection at the surgical site (4%)
- ◆ Chest pain (3%)
- ◆ Dizziness (3%)
- ◆ Increased tension of the muscles (3%)
- ◆ Vocal cord paralysis (3%)
- ◆ Skin rash (3%)
- ◆ Inability to pass urine (urinary retention) (3%)

Many of these side effects resolved within 30 days, but in some cases the side effects persisted beyond 90 days. Voice alteration was particularly likely to persist for longer than 90 days.

- ◆ Implantation of the Lead may cause nerve constriction (squeezing of the nerve). Call your doctor right away if your voice is always hoarse a few days after surgery. (There could be other explanations for this symptom.)

### 6.2.2. Infrequent surgical side effects

Surgical side effects that were reported in the D-02 study less frequently than those listed above, but by at least 1% of patients, were as follows: allergic reactions, weakness, fever, bleeding, heart palpitations, difficulty sleeping, neck rigidity, loss of appetite, heartburn, vomiting, bruising, swelling, itching, ear pain, ringing in the ears, and tightness in the throat. Additional serious side effects (reported in less than 1% of patients) were: transient heart stoppage (occurred in the operating room), decrease in heart rate (occurred in the recovery room), abnormal thinking (occurred in the post-operative period, thought due to narcotics), aspiration pneumonia (occurred in the post-operative period), and acute kidney failure.

### 6.2.3. Surgical scars

There are surgical techniques that may minimize surgical scars. Talk to your surgeon if you have specific concerns.

### 6.3. Stimulation of the Vagus Nerve

Side effects can occur from stimulation of the vagus nerve by the VNS Therapy System. Generally, the side effects become less noticeable over time for most patients. Only 3% of patients discontinued VNS Therapy because of side effects during the first year of treatment in the D-02 study. Sometimes your doctor can lessen the side effects by changing the device settings.



The VNS Therapy System is not a drug. It does not cause drug-related side effects and does not interact with drugs, including antidepressant medications you may be taking.

**6.3.1. Side effects that may occur from stimulation of the vagus nerve**

Table 1 shows the side effects that were most commonly reported as being related to stimulation of the vagus nerve by the VNS Therapy System during the D-02 study. Side effects reported in at least 3% of the patients are included. Table 1 shows the percentage of patients who had these side effects after 3 months, 12 months, and 24 months of stimulation.

**Table 1. Stimulation-Related Side Effects Reported by Greater Than or Equal To 3% of Patients—Study D-02**

	Months of stimulation		
	3	12	24
Voice alteration	59%	54%	52%
Increased cough	24%	7%	4%
Shortness of breath	14%	16%	14%
Neck pain	16%	13%	15%
Difficulty swallowing	13%	5%	5%
Paresthesia (tingling)	11%	4%	4%
Tightness in throat	10%	6%	5%
Pain	6%	6%	5%
Nausea	6%	1%	1%
Pharyngitis (inflammation of the throat)	6%	5%	4%
Headache	5%	3%	3%
Chest pain	4%	2%	2%
Heart palpitations	4%	3%	2%
Difficulty sleeping	4%	1%	1%
Heartburn	3%	2%	2%
Increased muscle tension	3%	4%	3%

While many of the incidences of these side effects resolved over time, some patients continued to report the side effects throughout the study. This was particularly true for voice

alteration, shortness of breath, and neck pain. Some of the side effects caused by stimulation typically occur only during stimulation (the ON time of the stimulation cycle).

**6.3.2. Other side effects reported during VNS Therapy**

The following is an alphabetical list of additional side effects reported as at least possibly due to vagus nerve stimulation during the 12-month D-02 study: abnormal dreams, abnormal thinking, agitation, amenorrhea (stoppage of menstrual periods), amblyopia (visual disturbance), amnesia, anxiety, arthralgia (joint pain), asthma, colitis, constipation, deafness, diarrhea, dry mouth, emotional lability, eruciation (belching), eye pain, flatulence, flu syndrome/viral infection, gastritis, hiccup, hypertension (high blood pressure), hypotension (low blood pressure), increased appetite, laryngitis, migraine, myalgia (muscle ache), myasthenia (muscle weakness), nervousness, postural hypotension (low blood pressure upon standing), rhinitis, sedation, stridor, sweating, syncope (fainting), tachycardia (fast heart beat), tremor, twitching, vasodilatation (flushing), weight gain, weight loss.

**6.4. Additional Safety Considerations**  
**6.4.1. Worsening depression**

People who have depression can experience waxing and waning of their depressive symptoms even while receiving treatment. During the first phase of the D-02 study when half the patients had their VNS Therapy System turned on and the other half did not, the study doctors reported 12 serious events of worsening depression requiring hospitalization. Four of these events occurred in patients who had their device turned on, and the other

eight occurred in patients who did not have their device turned on. During the long-term phase of the D-02 study (months 3 through 12), study doctors reported 62 additional serious events of worsening depression in 31 patients. If your depression worsens during VNS Therapy, inform your doctor promptly.

#### **6.4.2. Mania**

Some patients being treated for depression may experience a manic or hypomanic episode characterized by an abnormal and persistently elevated or irritable mood. Patients with known bipolar disorder (manic depressive illness) are the people most likely to experience this phenomenon. It is believed that effective antidepressant treatments themselves can cause a manic or hypomanic episode. In the D-02 study (through the 12-month long-term phase), six hypomanic or manic episodes were observed. Five of the six patients had a known history of prior hypomanic or manic episodes. One of these events was considered serious enough to require hospitalization; the other five events were either treated with medication or only required observation. If you experience symptoms of an elevated or irritable mood during VNS Therapy, inform your doctor promptly.

#### **6.4.3. Suicides**

People with depression may experience the emergence of suicidal thoughts and behavior (suicidality) whether or not they are receiving treatment. In the D-02 study (through the 12-month long-term phase), there were one suicide and seven additional suicide attempts in six patients. If you or someone else notices your depression worsening or indications of suicidality, inform your doctor promptly. Additionally, if you or someone else notices any of the following symptoms, inform your doctor immediately as they may indicate an increased risk of suicide: new or worse anxiety, feeling agitated or restless, panic attacks, difficulty sleeping, new or worse irritability, acting aggressive, being angry or violent, acting on dangerous impulses, an extreme increase in activity and talking, other unusual changes in behavior or mood.

#### **6.4.4. Deaths that occurred during the depression studies**

In the D-02 study (through the 12-month long-term phase), there were four deaths. One occurred in a patient who had enrolled in the study but had not yet received a VNS Therapy System implant. The causes of death for the other three patients were as follows: suicide (described above), sudden death of unknown cause, multi-organ system failure.

## 6.5. Analysis of Medical Device Reports Submitted to FDA from July 1, 1997 through October 8, 2004 for the VNS Therapy System Epilepsy Indication

Once a medical device is approved for commercial distribution, the United States Food and Drug Administration (FDA) regulations require certain parties, including manufacturers of medical devices, to report to the FDA deaths and serious injuries to which a device has or may have caused or contributed. The required report is referred to as a medical device report (MDR). The FDA Office of Biometrics and Surveillance analyzed all MDRs submitted for the VNS Therapy System from July 1, 1997 through October 8, 2004. During this period, the VNS Therapy System had a single approved indication, epilepsy. The analysis included 2,887 reports, 2,453 of which were reported from sites within the United States. By the end of the period analyzed, there were 32,065 VNS Therapy device implants and 80,144 device-years of implant experience (the presence of the implanted device in an individual for a full year equals one "device-year"). It is important to emphasize that, although the events occurred during treatment with the VNS Therapy System, the submission of an MDR does not necessarily mean the product caused or contributed to the event being reported.

### 6.5.1. Deaths

A total of 524 deaths were reported to the FDA during the period from July 1, 1997 through October 8, 2004. By the end of the period, there were 32,065 VNS Therapy device implants and 80,144 device-years of implant experience. Of the 524 deaths, 102 (20%) were of an "unknown cause," including 24 deaths of unknown cause that occurred during sleep (5% of total deaths). Of those deaths with a reported cause, the following were the most common etiologies:

- ◆ seizure disorder (152 reports; 29% of total deaths), including sudden unexplained death in epilepsy and status epilepticus (These are recognized risks in patients with epilepsy—the rate of sudden unexplained death in patients treated with VNS Therapy is within the range of the rates reported for similar patients who are treated with antiepileptic drugs without VNS Therapy.)
- ◆ respiratory events (99 reports; 19% of total deaths), including pneumonia, pulmonary edema, reduced oxygen supply to body tissues
- ◆ cardiac events (51 reports; 10% of total deaths), including heart stoppage, heart attack, and irregular heart beat
- ◆ neurovascular events (24 reports; 5% of total deaths), including stroke and brain hemorrhage (bleeding)
- ◆ cancer (19 reports; 3% of total deaths), including brain and colon
- ◆ suicide (9 reports; 2% of total deaths)

### 6.5.2. Serious injuries

A total of 1,644 serious injuries were reported to the FDA during the period from July 1, 1997 through October 8, 2004. By the end of the period, there were 32,065 VNS Therapy device implants and 80,144 device-years of implant experience. The most frequently reported serious injury was infection (525 reports). Approximately 40% of these were known to have required device removal. The second most common serious injury reported was increased seizure activity (324 reports). Others included:

- ◆ vagus nerve injury (181 reports) including vocal cord paralysis (109) and hoarseness (71)
- ◆ respiratory injuries (141 reports) including sleep apnea (cessation of breathing during sleep, 33 reports) shortness of breath (50), and aspiration (inhaling foreign matter or stomach contents into the lungs, 14 reports)
- ◆ cardiac events (123 reports) including fast or slow heart rates, palpitations, high or low blood pressure, fainting, and cessation of heart beat
- ◆ pain (81 reports) including chest and neck pain
- ◆ gastrointestinal events (60 reports) including difficulty swallowing (24) and weight loss (24)
- ◆ depression (21 reports)

Of the 1,644 reports of serious injury, 694 (42%) were associated with subsequent device removal in that subject.

### 6.5.3. Device malfunctions

A total of 708 device malfunctions were reported to the FDA during the period from July 1, 1997 through October 8, 2004. By the end of the period, there were 32,065 VNS Therapy device implants and 80,144 device-years of implant experience. Some of the most common malfunctions reported were an abnormal lead test (which can be indicative of a poor connection between the lead and vagus nerve or lead and generator or can indicate a broken lead, 351 reports), lead breakage (116), device failure (44), and a shift in device location (20).

## 7. BENEFITS OF VNS THERAPY

The effectiveness of VNS Therapy in decreasing depressive symptoms was primarily demonstrated by improved scores on standardized tests after 12 months and 24 months of VNS Therapy in the D-02 study. See "Overview of Clinical Studies" in the preceding section for a description of the D-02 study.

### 7.1. Effectiveness Results From the D-02 Clinical Study

#### 7.1.1. Three-month results

At the end of the first 3 months, the proportion of patients who had at least a 50% reduction in depression symptoms was 15% in the group of patients receiving active stimulation, slightly better than for patients who were not receiving stimulation (10% of these patients had at least a 50% reduction in symptoms). (See Table 2.) This finding suggested that the full effects of VNS Therapy might require more than 3 months of treatment.

#### 7.1.2. One-year results

After 1 year of VNS Therapy, the results showed that 30% of the study patients were responders (at least a 50% improvement in depressive symptoms) and 17% were remitters (minimal to no depressive symptoms). The results from a second rating scale of depression symptoms showed that 22% of the group were responders and 15% were remitters, and the results from a third rating scale showed that 32% were responders and 23% were remitters (see Table 2). It should be noted that about one in four or five people who were implanted with the device during the study were not included in these calculations of success at 12

Patient/Depression-30

months. Therefore it is possible that the percentage of patients having successful outcomes may be lower than is represented by the results described above.

#### 7.1.3. Two-year results

After 2 years of VNS Therapy, the results showed that 32% of the patients were responders and 17% were remitters. The results from a second rating scale of depression symptoms showed that 27% of the group were responders and 13% were remitters (see Table 2). It should be noted that about one in three people who were implanted with the device during the study were not included in these calculations of success at 24 months. Therefore it is possible that the percentage of patients having successful outcomes may be lower than is represented by the results described above.

**Table 2.** Percent of Responders and Remitters After VNS Therapy

Standardized Test	HRSD <sup>14</sup>		IDS-SR		MADRS	
	Responders	Remitters	Responders	Remitters	Responders	Remitters
3 months	15%	7%	14%	6%	17%	10%
12 months	30%	17%	22%	15%	32%	23%
24 months	32%	17%	27%	13%	N/A	N/A

Responders - ≥50% improvement in depressive symptoms.  
Remitters - minimal to no depressive symptoms.

Patient/Depression-31

**Figure 3. Categories of Clinical Benefit After 12 Months of VNS Therapy (HRSD<sub>24</sub>)**

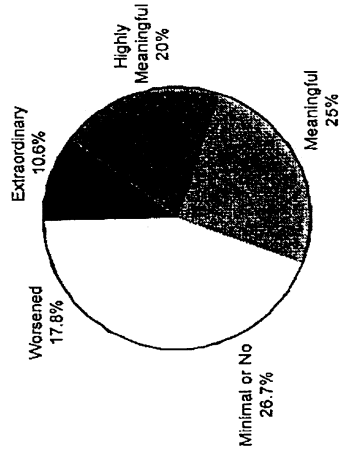

**7.1.4. Additional categorization of clinical benefit**

After 12 months of VNS Therapy, the patients were also assessed to categorize the degree of improvement in their depression symptoms. The amount of improvement was categorized as follows:

- Worsened** – depressive symptoms worse than when VNS Therapy was started
- Minimal to no change** – 0% to 24% improvement in depressive symptoms
- Meaningful clinical benefit** – 25% to 49% improvement in depressive symptoms
- Highly meaningful clinical benefit** – 50% to 74% improvement in depressive symptoms
- Extraordinary clinical benefit** – over 75% improvement in depressive symptoms

Figure 3 shows the percentage of patients who were in the different categories after 12 months of VNS Therapy. It should be noted that about one in four people who were implanted with the device during the study were not included in these calculations of success at 12 months. Therefore it is possible that the percentage of patients having successful outcomes may be lower than is represented by the results shown in the figure.

**7.1.5. Maintenance of benefit over time**

Although less than one in three or one in four patients (depending on the rating scale used) appeared to respond to VNS Therapy, most—but not all—of those patients continued to be responders over time. For example, among the 30 patients who were responders on the HRSD<sub>24</sub> rating after their first 3 months of VNS Therapy, 60% continued to be responders after one year of VNS Therapy, and 70% were responders after two years of VNS Therapy. Among the 54 patients who were responders after 12 months of VNS Therapy, 69% continued to be responders after two years of VNS Therapy.

## 7.2. Quality of Life Measurements in the D-02 Clinical Study

In addition to improvements in depressive symptoms, patients who received VNS Therapy for one year in the D-02 study reported improvements in quality of life.

## 7.3. Expected Rate of Response to VNS Therapy

For patients in whom VNS Therapy is effective, the benefits are not always seen right away. In fact, the 12-week acute studies did not show a significant difference between patients receiving VNS Therapy and those who were not receiving it. Depressive symptoms may improve slowly over the first year of treatment.

## 7.4. Treatment Continuation Rates

Not all patients continue on VNS Therapy. During the D-02 study, 92% of the patients continued to receive therapy at 12 months and 82% continued to receive therapy at 24 months.

## 7.5. Limitations of VNS Therapy

VNS Therapy has not been shown to cure depression. It does not work for everyone. For most patients in whom it is effective, improvement in depressive symptoms will be slow (see “Expected Rate of Response to VNS Therapy” above). Some patients may have no change in symptoms with VNS Therapy, and some may actually get worse while receiving VNS Therapy. At present, doctors have no way to predict which patients will respond to VNS Therapy.

## 8. HAVING THE DEVICE IMPLANTED

VNS Therapy requires surgical placement of the Pulse Generator and Lead by a surgeon. At office visits, your doctor checks the settings and changes them as needed.

### 8.1. Surgery (Operation)

Surgery lasts from about 1 to 2 hours and typically involves general anesthesia, though local anesthesia is sometimes used. You may stay in the hospital overnight.

The surgeon makes a small incision on the left side of the neck and a second incision below the collarbone in the chest or armpit. The surgeon passes the Lead under the skin between the two incisions. Next the surgeon attaches the Lead to the left vagus nerve in the neck. Then the surgeon attaches the other end of the lead to the Pulse Generator, which is subsequently placed in a “pocket” created at the site of the incision that was made below the collarbone. Finally, the surgeon closes the incisions. See Figure 1.

⚠ The operation can be reversed if you and your doctor ever decide to have the VNS Therapy System removed. Removal of the generator and/or lead requires another surgical procedure. Sometimes when a surgeon removes a VNS Therapy System, the surgeon will decide to leave a portion of the Lead behind in order not to risk damaging the vagus nerve. This may pose certain risks (see the “Medical Hazards” section of this manual).

## 8.2. Follow-up After Surgery

The Pulse Generator is usually turned on 2 weeks after it is implanted. (Your doctor will program the Pulse Generator to the proper settings for you.) At that office visit and at subsequent visits, your doctor will check the VNS Therapy System. Your doctor will make sure that it is working well and that the treatment is not uncomfortable for you.

**⚠️ Cyberonics recommends that you see your doctor at least once every 6 months. Your doctor will check the VNS Therapy System for safe and effective operation.**

You will be given an Implant and Warranty Registration Card. It has information about your Pulse Generator and Lead.

You will also receive a Patient Emergency Information Card. It has phone numbers to call in case of a device-related emergency.

**⚠️ Carry the Patient Emergency Information Card at all times.**

**⚠️ Your doctor is your first source for health-related questions and information. Cyberonics *cannot* provide health care advice or services.**

## 8.3. Antidepressant Medications

Most patients treated with VNS Therapy in the clinical studies also continued to take antidepressant medications. A significant number of patients had new medications added or doses of their old medications increased during the studies.

Your doctor may advise you to continue taking your antidepressant medications after you begin receiving VNS Therapy. Your doctor may also decide to add new medications to your treatment. Always follow your doctor's instructions regarding your medications.



## 9. THE CYBERONICS MAGNETS

### 9.1. Handling the Cyberonics Magnets

After your operation, your doctor will give you two magnets. You should carry one of the Magnets with you at all times in your pocket, in your purse away from credit cards, or in another convenient place. If you prefer, you can wear them like a watch or a pager (see Figure 4).

If the Magnets are handled carefully, they should last many years.

Figure 4. The Cyberonics Magnets

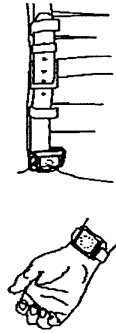

Cyberonics Magnet (watch-style)

Cyberonics Magnet (pager-style)

- ⚠ **Never put or store the Magnets near credit cards, televisions, computers, computer disks, microwave ovens, watches, or other magnets. Keep them at least 10 inches (25 centimeters) away.**
- ⚠ **Do not drop the Magnets. They can break if dropped on a hard surface.**
- ⚠ **Carry a Magnet with you at all times. Show your family members or caregivers how to use the Magnet.**

### 9.2. Using Your Cyberonics Magnets

Keep a Magnet with you at all times in case you need to turn OFF the Pulse Generator.

The Magnet can be used to stop stimulation temporarily or turn OFF the Pulse Generator:

- ♦ when you plan to sing or speak in public (if stimulation bothers you when you do this)
- ♦ when you are eating (if you have swallowing problems)
- ♦ if stimulation becomes uncomfortable or painful

⚠ The correct position for the Magnet may vary from patient to patient. The position depends on how the Pulse Generator is implanted. Find the position that works best for you.

### 9.2.1. To stop stimulation

1. Put the Magnet over the Pulse Generator (see Figure 5). If the stimulation stays on, move the Magnet around until it stops.

Figure 5. Stopping Stimulation

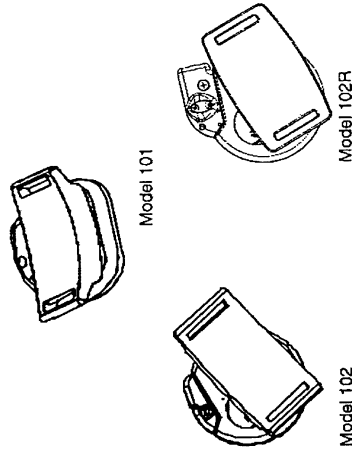

Model 102

Model 102R

- Note:** To show the correct position of the Magnet with the Pulse Generator, the Magnet has been drawn without the belt clip or wristband. The belt clip and wristband use the same Magnet.
2. Leave the Magnet over the Pulse Generator. If needed, tape it to your chest or use an elastic, wrap-around bandage.
  3. If you stopped the stimulation because it was painful or felt unusual, call your doctor right away.

*The Pulse Generator will not stimulate while the Magnet is in place, but it will start when the Magnet is removed.*

### 9.3. How the Magnets Work

The VNS Therapy System senses a magnetic field. Holding a Magnet over the Pulse Generator causes a Reed Switch inside the Pulse Generator to close. This switch works like a gate. When the Magnet closes it, the signal (stimulation) cannot pass. The Pulse Generator is temporarily turned OFF.

When the Magnet is removed, the switch (gate) opens right away. The VNS Therapy System is turned back ON and can stimulate again.

#### 9.3.1. Finding the Reed Switch

You may need to move the Magnet around to find the Reed Switch and stop stimulation (Figure 6).

The label side of the Magnet should face the Reed Switch. Figure 6 shows the position of the switch.

Figure 6. Reed Switch Position

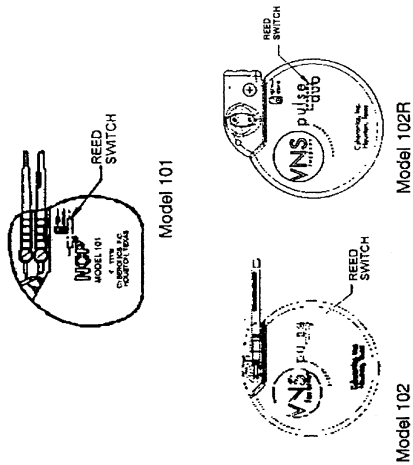

- ◆ **If stimulation hurts**, hold the Magnet over the Pulse Generator and keep it there. The stimulation will stop as long as the Magnet is there. If necessary, tape the Magnet in place. Contact your doctor right away.
- ◆ **Always carry the Magnet with you.** If you have pain because of stimulation, you can stop it by placing the Magnet over the Pulse Generator.
- ◆ **Keep the Magnets away from credit cards, computer disks, watches, and other items affected by strong magnetic fields.**
- ◆ **If you lose one of your Magnets**, you may buy a new one from Cyberonics. A Magnet Order Form is included in your Patient Essentials Kit. You may also buy new Magnets by contacting Cyberonics' Customer Service department (see number on back cover of this manual).
- ◆ **And remember**—if you are not sure about using the Magnets, ask your doctor to show you how.



All Magnets can lose their effectiveness over time. If you suspect that either of your Magnets is not working, call your doctor.

### 9.4. Replacing the Cyberonics Magnets

To order a new Magnet, contact Cyberonics' Customer Service department at the number on the back cover of this manual. A Magnet Order Form, with prices, is included in your Patient Essentials Kit.

### 9.3.2. Know your Magnets

These tips are also given elsewhere in these instructions. Be sure that you understand them.

- ◆ Use the Magnet only when necessary to turn off stimulation.
- ◆ **With your doctor's permission, it is okay to leave the Magnet in place for a short while, for example, to sing a song.** The Pulse Generator will not stimulate while the Magnet is in place. The stimulation cycle begins again when the Magnet is removed.

## 10. OTHER IMPORTANT INFORMATION ABOUT YOUR VNS THERAPY SYSTEM

### 10.1. Device Complications

Complications linked to the VNS Therapy System can result from:

- ◆ Surgery
- ◆ Pulse Generator malfunction (not working)
- ◆ Battery depletion (running out)
- ◆ Touching or moving the device through the skin

#### 10.1.1. Surgery

Like a heart pacemaker, the VNS Therapy device is implanted during surgery. One incision is made in the neck to attach the Lead to the vagus nerve, and a second incision is made in the chest for the Pulse Generator. All types of surgery carry some risks. In addition to the risks described in the earlier section of this Manual that summarized the experience from clinical studies, there are potential mechanical complications related to the surgical implantation of the device. The Pulse Generator and/or Lead can—but rarely do—move or come through the skin. Also, the Lead can break or become disconnected from the Pulse Generator.

### 10.1.2. Pulse Generator malfunction (device not working right)

The Pulse Generator can malfunction, though this is rare. The stimulation from a Pulse Generator that is not working right can cause intense neck pain, hoarseness, choking, or trouble breathing.

 Stimulation from a Pulse Generator that is not working right could damage the vagus nerve and lead to permanent hoarseness or other complications. Malfunction of the Pulse Generator could cause the battery to run out sooner than expected. If you have any of these symptoms, or if stimulation becomes painful, irregular, or nonstop, place the Magnet over the Pulse Generator. Hold it there to stop stimulation (see the “Using Your Cyberonics Magnets” section of this manual). Then call your doctor right away.

### 10.1.3. Battery depletion (running out)

The battery in your Pulse Generator will normally last between 1 to 16 years, depending on the settings. The Pulse Generator battery will slowly lose its power when it starts to run out. It will begin to stimulate differently. You may sense this change as irregular stimulation. At the end, the stimulation will stop completely.

 *After stimulation stops (when the Pulse Generator battery runs out), you may notice a change in your depressive symptoms. If you think that the Pulse Generator might not be working right, call your doctor.*

When the battery in your Pulse Generator runs out, the Pulse Generator must be replaced in order for you to continue to receive VNS Therapy. This requires an additional surgical procedure. The operation involves anesthesia and generally takes less than an hour to complete.

Replacement or removal of the Lead is a different procedure. It is not required for routine replacement of the Pulse Generator.

#### **10.1.4. Manipulation of the Pulse Generator and Lead**

The Pulse Generator is secured into place during surgery, but the device can move slightly. It may be possible to feel the Lead under the skin after surgery. This feeling is normal. It should become less apparent over time (several weeks). Manipulation of the Lead should be prevented at all times.

 *Never move or twist the Pulse Generator or manipulate the Lead. Doing so could damage the Lead or your vagus nerve. It could require that the Pulse Generator and Lead be replaced.*

## **11. CYBERONICS' PATIENT WARRANTY AND SAFETY LISTING**

Government agencies require makers of implantable devices to contact people in case of emergencies related to the device. Cyberonics has a listing of people who have had the Pulse Generator and Lead implanted. The information is kept in confidential files. It is a permanent record of the implantation surgery. Cyberonics will release a file only if required by law.

 *Please send Cyberonics a change of address notice if you move.*

## 12. FREQUENTLY ASKED QUESTIONS

Patients and their family members often ask these questions.

**How do most people respond to VNS Therapy?** When the device was tested in the clinical trials, depressive symptoms decreased for most patients. Some patients had no change in depressive symptoms and some got worse while receiving VNS Therapy. Among those patients who did improve while receiving VNS Therapy, some did not improve until they had been receiving VNS Therapy for 6 months or longer.

**Can I know if I will be helped before I am implanted with the Pulse Generator and Lead?** At this time, there is no way to predict what your response will be.

**What are the results of the VNS Therapy clinical studies?** This Manual provides a summary of important safety and effectiveness results from the clinical studies. Your doctor can give you more information about the clinical (research) studies.

**What is the implantation surgery like?** You will be given a general or local anesthetic. The operation usually takes 1 to 2 hours. The operation will be done with you as an outpatient (you go home the same day) or you may stay in the hospital overnight. Ask your surgeon to tell you more about the anesthetic, the operation, and the hospital stay so that you will know what to expect.

**Are there risks linked with the surgery?** Any surgery has some type of risk. It is important that you discuss this question with your surgeon.

**Will the scars be noticeable?** Each person has different healing and scarring results. You should expect some scarring from surgery. Most people do not think the scarring after surgery is a major concern. If this is a special concern for you, discuss it with your surgeon.

**Will people be able to see the implanted device through my skin?** The Pulse Generator is shaped like a disk. The Model 101 is 5.4 centimeters (2.1 inches) across and 1 centimeter (0.4 inch) thick; it weighs about 38 grams (1.34 ounces). The Model 102 is 5.2 centimeters (2.0 inches) across and 0.7 centimeter (0.27 inch) thick; it weighs about 25 grams (0.88 ounce). The Model 102R is 5.2 centimeters (2.0 inches) by 5.8 centimeters (2.3 inches) and 0.7 centimeter (0.27 inch) thick, weighing about 27 grams (0.95 ounce). If you have a small frame or are very thin, the device may be visible below your left collarbone.

**What happens after the surgery?** After surgery (usually 2 weeks later), your doctor will set the treatment settings of your device. If the stimulation feels uncomfortable, your doctor can change it to make you more comfortable. The doctor will use the Programming Wand to check and fine-tune your stimulation settings at subsequent visits.

**Will I be able to tell when the stimulator is on?** Many people note a change in their voice (often described as hoarseness) or discomfort in the neck (typically mild pain or a tingling sensation) during stimulation. In general, most side effects become less noticeable over time.

**What are the side effects of VNS Therapy?** The most common side effects reported during VNS Therapy are voice alteration (often described as hoarseness), discomfort in the neck (typically mild pain or a tingling sensation), cough, shortness of breath, difficulty swallowing, and a feeling of tightness in the throat. Often these events only occur when the stimulator is ON. Other less common side effects are discussed in the earlier section of this manual that summarized the experience from clinical studies. In general, most side effects become less noticeable over time.

**When should I use the Magnet?** Use the Magnet to stop stimulation temporarily or to turn OFF the Pulse Generator when you plan to sing or speak in public (if stimulation bothers you when you do this), when you are eating (if you have swallowing problems), or if stimulation becomes uncomfortable or painful. If you need to use the Magnet for any of these reasons or any other reason, inform your physician.

**How does the Magnet work?** The Pulse Generator has a sensor (the Reed Switch) that recognizes the Magnet and stops stimulation.

**Can any magnet be used?** Only the Cyberonics Magnet should be used with your VNS Therapy System. If you lose your Magnet or require extra Magnets, contact your doctor. In an emergency, you may try other strong magnets. The use of other, non-Cyberonics magnets will not harm the VNS Therapy System. But there is no way to know in advance whether a magnet other than the Cyberonics Magnet will work.

**What if the Magnet is accidentally kept in place over the Pulse Generator for an extended period?** No stimulation will be

delivered while the Magnet is kept over the device. Stimulation will resume only after the Magnet is removed.

**Is it possible to stop all stimulation using the Magnet?** Yes. To stop stimulation, hold the Magnet over the Pulse Generator and keep it there. Use this method if you have unusual or painful stimulation. Then call your doctor right away. The Magnet will stop all stimulation while it is held in place. You may need to secure the Magnet by taping it over the implanted device.

**Who should carry the Magnet?** You should carry the Magnet so that it is always with you. You may also want your family members or caregivers to have access to a Cyberonics Magnet.

**Is the Magnet an environmental hazard?** The Cyberonics Magnet can damage computer disks, credit cards, watches, and other items affected by strong magnetic fields. Keep your Magnet at least 25 centimeters (10 inches) away from any of these items. Do not store Magnets near such items.

**Other Questions?** If you have other questions about the VNS Therapy System, any of its parts, or VNS Therapy in general, talk to your doctor.



FDA Home Page | CDRH Home Page | Search | CDRH A-Z Index | Contact CDRH

## CDRH Consumer Information

Consumer Home

Product Index and Information

Choosing a Medical Device

How We Can Help

Resources

Problems with Medical Devices



See Related Information

## New Device Approval

### VNS Therapy System - P970003s050

This is a brief overview of information related to FDA's approval to market this product. See the links below to the Summary of Safety and Effectiveness and product labeling for more complete information on this product, its indications for use, and the basis for FDA's approval.

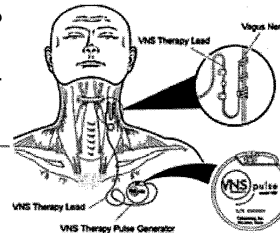

**Product Name:** VNS Therapy System

**Manufacturer:** Cyberonics, Inc.

**Address:** 100 Cyberonics Blvd., Houston, TX 77058

**Approval Date:** July 15, 2005

**Approval Letter:** <http://www.fda.gov/cdrh/pdf/p970003s050a.pdf>

**What is it?** The device is a totally implanted vagus nerve stimulator (VNS) for the long-term treatment of chronic or recurrent depression which has not responded to usual treatments. The device was initially approved in 1997 for epilepsy.

**How does it work?** A pulse generator, similar to a pacemaker, is surgically implanted under the skin of the left chest and an electrical lead (wire) is connected from the generator to the left vagus nerve. Electrical signals are sent from the battery-powered generator to the vagus nerve via the lead. These signals are in turn sent to the brain. To turn the stimulator off, the patient holds a magnet over the pulse generator.

**When is it used?** The device is to be used only in patients 18 years of age or over with treatment-resistant depression (TRD). These are patients who have been treated with, but failed to respond to, at least 4 adequate medication and/or ECT treatment regimens prescribed by their physician. It is not intended to be used as a first-line treatment, even for patients with severe depression. It should be prescribed and monitored only by physicians who have specific training and expertise in the management of treatment-resistant depression and the use of this device. It should be implanted only by physicians who are trained in surgery of the carotid sheath and have received specific training in the



implantation of this device.

**What will it accomplish?** The VNS Therapy System is intended to reduce symptoms of depression. However, this therapy may be required for several months before any benefit is noticed by the patient. Not all patients receiving this therapy will respond to the same degree, if at all. Based on the results of a clinical study of over 200 patients conducted in the United States, during the first 3 months of therapy, patients who had the device implanted and turned on did not show any significant advantage in response compared to patients in whom the device was implanted but not turned on. At 1 year, approximately 2 or 3 out of every 10 subjects had a clinically significant improvement in symptoms of depression with about half that number having almost no remaining depressive symptoms. Many of the patients who had a significant response within the first year of treatment continued to have a similar degree of response through 2 years.

Some patients, however, had no improvement in symptoms and some actually got worse. This therapy is intended to be given along with other traditional therapies, such as medications and ECT, and patients should not expect to discontinue these other treatments, even with the device in place. Patients will require regular visits to their physicians for adjustments to their device and other treatments. Patients receiving VNS therapy may experience various side effects from the stimulation including hoarse voice, cough, shortness or breath, difficulty swallowing, and neck pain, some of which may persist as long as the device is active.

**When should it not be used?** It cannot be used in patients who have had their vagus nerve cut or who will be exposed to diathermy which is a form of ultrasound.

**Additional information:** Summary of Safety and Effectiveness and labeling are available at:  
<http://www.fda.gov/cdrh/pdf/p970003s050.html>

Updated August 12, 2005



---

---

APPENDIX C—FDA REGULATIONS

---

---

## § 10.70

## 21 CFR Ch. I (4–1–05 Edition)

(1) The person requesting a meeting may be accompanied by a reasonable number of employees, consultants, or other persons with whom there is a commercial arrangement within the meaning of §20.81(a) of this chapter. Neither FDA nor any other person may require the attendance of a person who is not an employee of the executive branch of the Federal Government without the agreement of the person requesting the meeting. Any person may attend by mutual consent of the person requesting the meeting and FDA.

(2) FDA will determine which representatives of the agency will attend the meeting. The person requesting the meeting may request, but not require or preclude, the attendance of a specific FDA employee.

(3) A person who wishes to attend a private meeting, but who is not invited to attend either by the person requesting the meeting or by FDA, or who otherwise cannot attend the meeting, may request a separate meeting with FDA to discuss the same matter or an additional matter.

(d) FDA employees have a responsibility to meet with all segments of the public to promote the objectives of the laws administered by the agency. In pursuing this responsibility, the following general policy applies where agency employees are invited by persons outside the Federal Government to attend or participate in meetings outside agency offices as representatives of the agency.

(1) A person outside the executive branch may invite an agency representative to attend or participate in a meeting outside agency offices. The agency representative is not obligated to attend or participate, but may do so where it is in the public interest and will promote the objectives of the act.

(2) The agency representative may request that the meeting be open if that would be in the public interest. The agency representative may decline to participate in a meeting held as a private meeting if that will best serve the public interest.

(3) An agency representative may not knowingly participate in a meeting that is closed on the basis of gender, race, or religion.

(e) An official transcript, recording, or memorandum summarizing the substance of any meeting described in this section will be prepared by a representative of FDA when the agency determines that such documentation will be useful.

(f) FDA promptly will file in the appropriate administrative file memoranda of meetings prepared by FDA representatives and all correspondence, including any written summary of a meeting from a participant, that relate to a matter pending before the agency.

(g) Representatives of FDA may initiate a meeting or correspondence on any matter concerning the laws administered by the Commissioner. Unless otherwise required by law, meetings may be public or private at FDA's discretion.

(h) A meeting of an advisory committee is subject to the requirements of part 14 of this chapter.

[66 FR 6468, Jan. 22, 2001]

**§10.70 Documentation of significant decisions in administrative file.**

(a) This section applies to every significant FDA decision on any matter under the laws administered by the Commissioner, whether it is raised formally, for example, by a petition or informally, for example, by correspondence.

(b) FDA employees responsible for handling a matter are responsible for insuring the completeness of the administrative file relating to it. The file must contain:

(1) Appropriate documentation of the basis for the decision, including relevant evaluations, reviews, memoranda, letters, opinions of consultants, minutes of meetings, and other pertinent written documents; and

(2) The recommendations and decisions of individual employees, including supervisory personnel, responsible for handling the matter.

(i) The recommendations and decisions are to reveal significant controversies or differences of opinion and their resolution.

(ii) An agency employee working on a matter and, consistent with the prompt completion of other assignments, an agency employee who has

**Food and Drug Administration, HHS****§ 10.75**

worked on a matter may record individual views on that matter in a written memorandum, which is to be placed in the file.

(c) A written document placed in an administrative file must:

(1) Relate to the factual, scientific, legal or related issues under consideration;

(2) Be dated and signed by the author;

(3) Be directed to the file, to appropriate supervisory personnel, and to other appropriate employees, and show all persons to whom copies were sent;

(4) Avoid defamatory language, intemperate remarks, undocumented charges, or irrelevant matters (e.g., personnel complaints);

(5) If it records the views, analyses, recommendations, or decisions of an agency employee in addition to the author, be given to the other employees; and

(6) Once completed (i.e., typed in final form, dated, and signed) not be altered or removed. Later additions to or revisions of the document must be made in a new document.

(d) Memoranda or other documents that are prepared by agency employees and are not in the administrative file have no status or effect.

(e) FDA employees working on a matter have access to the administrative file on that matter, as appropriate for the conduct of their work. FDA employees who have worked on a matter have access to the administrative file on that matter so long as attention to their assignments is not impeded. Reasonable restrictions may be placed upon access to assure proper cataloging and storage of documents, the availability of the file to others, and the completeness of the file for review.

**§ 10.75 Internal agency review of decisions.**

(a) A decision of an FDA employee, other than the Commissioner, on a matter, is subject to review by the employee's supervisor under the following circumstances:

(1) At the request of the employee.

(2) On the initiative of the supervisor.

(3) At the request of an interested person outside the agency.

(4) As required by delegations of authority.

(b)(1) The review will be made by consultation between the employee and the supervisor or by review of the administrative file on the matter, or both. The review will ordinarily follow the established agency channels of supervision or review for that matter.

(2) A sponsor, applicant, or manufacturer of a drug or device regulated under the act or the Public Health Service Act (42 U.S.C. 262), may request review of a scientific controversy by an appropriate scientific advisory panel as described in section 505(n) of the act, or an advisory committee as described in section 515(g)(2)(B) of the act. The reason(s) for any denial of a request for such review shall be briefly set forth in writing to the requester. Persons who receive a Center denial of their request under this section may submit a request for review of the denial. The request should be sent to the Chief Mediator and Ombudsman.

(c) An interested person outside the agency may request internal agency review of a decision through the established agency channels of supervision or review. Personal review of these matters by center directors or the office of the Commissioner will occur for any of the following purposes:

(1) To resolve an issue that cannot be resolved at lower levels within the agency (e.g., between two parts of a center or other component of the agency, between two centers or other components of the agency, or between the agency and an interested person outside the agency).

(2) To review policy matters requiring the attention of center or agency management.

(3) In unusual situations requiring an immediate review in the public interest.

(4) As required by delegations of authority.

(d) Internal agency review of a decision must be based on the information in the administrative file. If an interested person presents new information not in the file, the matter will be returned to the appropriate lower level in

**§ 10.80****21 CFR Ch. I (4-1-05 Edition)**

the agency for reevaluation based on the new information.

[44 FR 22323, Apr. 13, 1979, as amended at 50 FR 8994, Mar. 6, 1985; 63 FR 63982, Nov. 18, 1998]

**§ 10.80 Dissemination of draft Federal Register notices and regulations.**

(a) A representative of FDA may discuss orally or in writing with an interested person ideas and recommendations for notices or regulations. FDA welcomes assistance in developing ideas for, and in gathering the information to support, notices and regulations.

(b) *Notices and proposed regulations.* (1) Once it is determined that a notice or proposed regulation will be prepared, the general concepts may be discussed by a representative of FDA with an interested person. Details of a draft of a notice or proposed regulation may be discussed with a person outside the executive branch only with the specific permission of the Commissioner. The permission must be in writing and filed with the Division of Dockets Management.

(2) A draft of a notice or proposed regulation or its preamble, or a portion of either, may be furnished to an interested person outside the executive branch only if it is made available to all interested persons by a notice published in the FEDERAL REGISTER. A draft of a notice or proposed regulation made available in this manner may, without the prior permission of the Commissioner, be discussed with an interested person to clarify and resolve questions raised and concerns expressed about the draft.

(c) After publication of a notice or proposed regulation in the FEDERAL REGISTER, and before preparation of a draft of the final notice or regulation, a representative of FDA may discuss the proposal with an interested person as provided in paragraph (b)(2) of this section.

(d) *Final notices and regulations.* (1) Details of a draft of a final notice or regulation may be discussed with an interested person outside the executive branch only with the specific permission of the Commissioner. The permission must be in writing and filed with the Division of Dockets Management.

(2) A draft of a final notice or regulation or its preamble, or any portion of either, may be furnished to an interested person outside the executive branch only if it is made available to all interested persons by a notice published in the FEDERAL REGISTER, except as otherwise provided in paragraphs (g) and (j) of this section. A draft of a final notice or regulation made available to an interested person in this manner may, without the prior permission of the Commissioner, be discussed as provided in paragraph (b)(2) of this section.

(i) The final notice or regulation and its preamble will be prepared solely on the basis of the administrative record.

(ii) If additional technical information from a person outside the executive branch is necessary to draft the final notice or regulation or its preamble, it will be requested by FDA in general terms and furnished directly to the Division of Dockets Management to be included as part of the administrative record.

(iii) If direct discussion by FDA of a draft of a final notice or regulation or its preamble is required with a person outside the executive branch, appropriate protective procedures will be undertaken to make certain that a full and impartial administrative record is established. Such procedures may include either:

(a) The scheduling of an open public meeting under §10.65(b) at which interested persons may participate in review of and comment on the draft document; or

(b) The preparation of a tentative final regulation or tentative revised final regulation under §10.40(f)(6), on which interested persons will be given an additional period of time for oral and written comment.

(e) After a final regulation is published, an FDA representative may discuss any aspect of it with an interested person.

(f) In addition to the requirements of this section, the provisions of §10.55 apply to the promulgation of a regulation subject to §10.50 and part 12.

(g) A draft of a final food additive color additive, or new animal drug regulation may be furnished to the petitioner for comment on the technical

## § 812.36

## 21 CFR Ch. I (4–1–05 Edition)

used to assess the change, a statement that no new risks were identified by appropriate risk analysis and that the verification and validation testing, as appropriate, demonstrated that the design outputs met the design input requirements. If another method of assessment was used, the notice shall include a summary of the information which served as the credible information supporting the change.

(B) For a protocol change, the notice shall include a description of the change (cross-referenced to the appropriate sections of the original protocol); an assessment supporting the conclusion that the change does not have a significant impact on the study design or planned statistical analysis; and a summary of the information that served as the credible information supporting the sponsor's determination that the change does not affect the rights, safety, or welfare of the subjects.

(4) *Changes submitted in annual report.* The requirements of paragraph (a)(1) of this section do not apply to minor changes to the purpose of the study, risk analysis, monitoring procedures, labeling, informed consent materials, and IRB information that do not affect:

(i) The validity of the data or information resulting from the completion of the approved protocol, or the relationship of likely patient risk to benefit relied upon to approve the protocol;

(ii) The scientific soundness of the investigational plan; or

(iii) The rights, safety, or welfare of the human subjects involved in the investigation. Such changes shall be reported in the annual progress report for the IDE, under § 812.150(b)(5).

(b) *IRB approval for new facilities.* A sponsor shall submit to FDA a certification of any IRB approval of an investigation or a part of an investigation not included in the IDE application. If the investigation is otherwise unchanged, the supplemental application shall consist of an updating of the information required by § 812.20(b) and (c) and a description of any modifications in the investigational plan required by the IRB as a condition of approval. A certification of IRB approval need not be included in the initial submission of

the supplemental application, and such certification is not a precondition for agency consideration of the application. Nevertheless, a sponsor may not begin a part of an investigation at a facility until the IRB has approved the investigation, FDA has received the certification of IRB approval, and FDA, under § 812.30(a), has approved the supplemental application relating to that part of the investigation (see § 56.103(a)).

[50 FR 25909, June 24, 1985; 50 FR 28932, July 17, 1985, as amended at 61 FR 51531, Oct. 2, 1996; 63 FR 64625, Nov. 23, 1998]

**§ 812.36 Treatment use of an investigational device.**

(a) *General.* A device that is not approved for marketing may be under clinical investigation for a serious or immediately life-threatening disease or condition in patients for whom no comparable or satisfactory alternative device or other therapy is available. During the clinical trial or prior to final action on the marketing application, it may be appropriate to use the device in the treatment of patients not in the trial under the provisions of a treatment investigational device exemption (IDE). The purpose of this section is to facilitate the availability of promising new devices to desperately ill patients as early in the device development process as possible, before general marketing begins, and to obtain additional data on the device's safety and effectiveness. In the case of a serious disease, a device ordinarily may be made available for treatment use under this section after all clinical trials have been completed. In the case of an immediately life-threatening disease, a device may be made available for treatment use under this section prior to the completion of all clinical trials. For the purpose of this section, an "immediately life-threatening" disease means a stage of a disease in which there is a reasonable likelihood that death will occur within a matter of months or in which premature death is likely without early treatment. For purposes of this section, "treatment use" of a device includes the use of a device for diagnostic purposes.

## Food and Drug Administration, HHS

## § 812.36

(b) *Criteria.* FDA shall consider the use of an investigational device under a treatment IDE if:

(1) The device is intended to treat or diagnose a serious or immediately life-threatening disease or condition;

(2) There is no comparable or satisfactory alternative device or other therapy available to treat or diagnose that stage of the disease or condition in the intended patient population;

(3) The device is under investigation in a controlled clinical trial for the same use under an approved IDE, or such clinical trials have been completed; and

(4) The sponsor of the investigation is actively pursuing marketing approval/clearance of the investigational device with due diligence.

(c) *Applications for treatment use.* (1) A treatment IDE application shall include, in the following order:

(i) The name, address, and telephone number of the sponsor of the treatment IDE;

(ii) The intended use of the device, the criteria for patient selection, and a written protocol describing the treatment use;

(iii) An explanation of the rationale for use of the device, including, as appropriate, either a list of the available regimens that ordinarily should be tried before using the investigational device or an explanation of why the use of the investigational device is preferable to the use of available marketed treatments;

(iv) A description of clinical procedures, laboratory tests, or other measures that will be used to evaluate the effects of the device and to minimize risk;

(v) Written procedures for monitoring the treatment use and the name and address of the monitor;

(vi) Instructions for use for the device and all other labeling as required under § 812.5(a) and (b);

(vii) Information that is relevant to the safety and effectiveness of the device for the intended treatment use. Information from other IDE's may be incorporated by reference to support the treatment use;

(viii) A statement of the sponsor's commitment to meet all applicable responsibilities under this part and part

56 of this chapter and to ensure compliance of all participating investigators with the informed consent requirements of part 50 of this chapter;

(ix) An example of the agreement to be signed by all investigators participating in the treatment IDE and certification that no investigator will be added to the treatment IDE before the agreement is signed; and

(x) If the device is to be sold, the price to be charged and a statement indicating that the price is based on manufacturing and handling costs only.

(2) A licensed practitioner who receives an investigational device for treatment use under a treatment IDE is an "investigator" under the IDE and is responsible for meeting all applicable investigator responsibilities under this part and parts 50 and 56 of this chapter.

(d) *FDA action on treatment IDE applications.* (1) *Approval of treatment IDE's.* Treatment use may begin 30 days after FDA receives the treatment IDE submission at the address specified in § 812.19, unless FDA notifies the sponsor in writing earlier than the 30 days that the treatment use may or may not begin. FDA may approve the treatment use as proposed or approve it with modifications.

(2) *Disapproval or withdrawal of approval of treatment IDE's.* FDA may disapprove or withdraw approval of a treatment IDE if:

(i) The criteria specified in § 812.36(b) are not met or the treatment IDE does not contain the information required in § 812.36(c);

(ii) FDA determines that any of the grounds for disapproval or withdrawal of approval listed in § 812.30(b)(1) through (b)(5) apply;

(iii) The device is intended for a serious disease or condition and there is insufficient evidence of safety and effectiveness to support such use;

(iv) The device is intended for an immediately life-threatening disease or condition and the available scientific evidence, taken as a whole, fails to provide a reasonable basis for concluding that the device:

(A) May be effective for its intended use in its intended population; or



**§ 812.38**

(B) Would not expose the patients to whom the device is to be administered to an unreasonable and significant additional risk of illness or injury;

(v) There is reasonable evidence that the treatment use is impeding enrollment in, or otherwise interfering with the conduct or completion of, a controlled investigation of the same or another investigational device;

(vi) The device has received marketing approval/clearance or a comparable device or therapy becomes available to treat or diagnose the same indication in the same patient population for which the investigational device is being used;

(vii) The sponsor of the controlled clinical trial is not pursuing marketing approval/clearance with due diligence;

(viii) Approval of the IDE for the controlled clinical investigation of the device has been withdrawn; or

(ix) The clinical investigator(s) named in the treatment IDE are not qualified by reason of their scientific training and/or experience to use the investigational device for the intended treatment use.

(3) *Notice of disapproval or withdrawal.* If FDA disapproves or proposes to withdraw approval of a treatment IDE, FDA will follow the procedures set forth in §812.30(c).

(e) *Safeguards.* Treatment use of an investigational device is conditioned upon the sponsor and investigators complying with the safeguards of the IDE process and the regulations governing informed consent (part 50 of this chapter) and institutional review boards (part 56 of this chapter).

(f) *Reporting requirements.* The sponsor of a treatment IDE shall submit progress reports on a semi-annual basis to all reviewing IRB's and FDA until the filing of a marketing application. These reports shall be based on the period of time since initial approval of the treatment IDE and shall include the number of patients treated with the device under the treatment IDE, the names of the investigators participating in the treatment IDE, and a brief description of the sponsor's efforts to pursue marketing approval/clearance of the device. Upon filing of a marketing application, progress reports shall be submitted annually in

**21 CFR Ch. I (4–1–05 Edition)**

accordance with §812.150(b)(5). The sponsor of a treatment IDE is responsible for submitting all other reports required under §812.150.

[62 FR 48947, Sept. 18, 1997]

**§ 812.38 Confidentiality of data and information.**

(a) *Existence of IDE.* FDA will not disclose the existence of an IDE unless its existence has previously been publicly disclosed or acknowledged, until FDA approves an application for premarket approval of the device subject to the IDE; or a notice of completion of a product development protocol for the device has become effective.

(b) *Availability of summaries or data.*  
(1) FDA will make publicly available, upon request, a detailed summary of information concerning the safety and effectiveness of the device that was the basis for an order approving, disapproving, or withdrawing approval of an application for an IDE for a banned device. The summary shall include information on any adverse effect on health caused by the device.

(2) If a device is a banned device or if the existence of an IDE has been publicly disclosed or acknowledged, data or information contained in the file is not available for public disclosure before approval of an application for premarket approval or the effective date of a notice of completion of a product development protocol except as provided in this section. FDA may, in its discretion, disclose a summary of selected portions of the safety and effectiveness data, that is, clinical, animal, or laboratory studies and tests of the device, for public consideration of a specific pending issue.

(3) If the existence of an IDE file has not been publicly disclosed or acknowledged, no data or information in the file are available for public disclosure except as provided in paragraphs (b)(1) and (c) of this section.

(4) Notwithstanding paragraph (b)(2) of this section, FDA will make available to the public, upon request, the information in the IDE that was required to be filed in Docket Number 95S-0158 in the Division of Dockets Management

**Food and Drug Administration, HHS****§ 814.39**

Drug Administration, 9200 Corporate Blvd., Rockville, MD 20850.

[51 FR 26364, July 22, 1986; 51 FR 40415, Nov. 7, 1986, as amended at 51 FR 43344, Dec. 2, 1986; 55 FR 11169, Mar. 27, 1990; 62 FR 40600, July 29, 1997; 63 FR 5253, Feb. 2, 1998; 65 FR 17137, Mar. 31, 2000; 65 FR 56480, Sept. 19, 2000; 67 FR 9587, Mar. 4, 2002]

**§ 814.37 PMA amendments and resubmitted PMA's.**

(a) An applicant may amend a pending PMA or PMA supplement to revise existing information or provide additional information.

(b) FDA may request the applicant to amend a PMA or PMA supplement with any information regarding the device that is necessary for FDA or the appropriate advisory committee to complete the review of the PMA or PMA supplement.

(c) A PMA amendment submitted to FDA shall include the PMA or PMA supplement number assigned to the original submission and, if submitted on the applicant's own initiative, the reason for submitting the amendment. FDA may extend the time required for its review of the PMA, or PMA supplement, as follows:

(1) If the applicant on its own initiative or at FDA's request submits a major PMA amendment (e.g., an amendment that contains significant new data from a previously unreported study, significant updated data from a previously reported study, detailed new analyses of previously submitted data, or significant required information previously omitted), the review period may be extended up to 180 days.

(2) If an applicant declines to submit a major amendment requested by FDA, the review period may be extended for the number of days that elapse between the date of such request and the date that FDA receives the written response declining to submit the requested amendment.

(d) An applicant may on its own initiative withdraw a PMA or PMA supplement. If FDA requests an applicant to submit a PMA amendment and a written response to FDA's request is not received within 180 days of the date of the request, FDA will consider the pending PMA or PMA supplement to be

withdrawn voluntarily by the applicant.

(e) An applicant may resubmit a PMA or PMA supplement after withdrawing it or after it is considered withdrawn under paragraph (d) of this section, or after FDA has refused to accept it for filing, or has denied approval of the PMA or PMA supplement. A resubmitted PMA or PMA supplement shall comply with the requirements of § 814.20 or § 814.39, respectively, and shall include the PMA number assigned to the original submission and the applicant's reasons for resubmission of the PMA or PMA supplement.

**§ 814.39 PMA supplements.**

(a) After FDA's approval of a PMA, an applicant shall submit a PMA supplement for review and approval by FDA before making a change affecting the safety or effectiveness of the device for which the applicant has an approved PMA, unless the change is of a type for which FDA, under paragraph (e) of this section, has advised that an alternate submission is permitted or is of a type which, under section 515(d)(6)(A) of the act and paragraph (f) of this section, does not require a PMA supplement under this paragraph. While the burden for determining whether a supplement is required is primarily on the PMA holder, changes for which an applicant shall submit a PMA supplement include, but are not limited to, the following types of changes if they affect the safety or effectiveness of the device:

(1) New indications for use of the device.

(2) Labeling changes.

(3) The use of a different facility or establishment to manufacture, process, or package the device.

(4) Changes in sterilization procedures.

(5) Changes in packaging.

(6) Changes in the performance or design specifications, circuits, components, ingredients, principle of operation, or physical layout of the device.

(7) Extension of the expiration date of the device based on data obtained under a new or revised stability or sterility testing protocol that has not been approved by FDA. If the protocol

## § 814.39

## 21 CFR Ch. I (4–1–05 Edition)

has been approved, the change shall be reported to FDA under paragraph (b) of this section.

(b) An applicant may make a change in a device after FDA's approval of a PMA for the device without submitting a PMA supplement if the change does not affect the device's safety or effectiveness and the change is reported to FDA in postapproval periodic reports required as a condition to approval of the device, e.g., an editorial change in labeling which does not affect the safety or effectiveness of the device.

(c) All procedures and actions that apply to an application under § 814.20 also apply to PMA supplements except that the information required in a supplement is limited to that needed to support the change. A summary under § 814.20(b)(3) is required for only a supplement submitted for new indications for use of the device, significant changes in the performance or design specifications, circuits, components, ingredients, principles of operation, or physical layout of the device, or when otherwise required by FDA. The applicant shall submit three copies of a PMA supplement and shall include information relevant to the proposed changes in the device. A PMA supplement shall include a separate section that identifies each change for which approval is being requested and explains the reason for each such change. The applicant shall submit additional copies and additional information if requested by FDA. The time frames for review of, and FDA action on, a PMA supplement are the same as those provided in § 814.40 for a PMA.

(d)(1) After FDA approves a PMA, any change described in paragraph (d)(2) of this section that enhances the safety of the device or the safety in the use of the device may be placed into effect by the applicant prior to the receipt under § 814.17 of a written FDA order approving the PMA supplement provided that:

(i) The PMA supplement and its mailing cover are plainly marked "Special PMA Supplement—Changes Being Effected";

(ii) The PMA supplement provides a full explanation of the basis for the changes;

(iii) The applicant has received acknowledgement from FDA of receipt of the supplement; and

(iv) The PMA supplement specifically identifies the date that such changes are being effected.

(2) The following changes are permitted by paragraph (d)(1) of this section:

(i) Labeling changes that add or strengthen a contraindication, warning, precaution, or information about an adverse reaction.

(ii) Labeling changes that add or strengthen an instruction that is intended to enhance the safe use of the device.

(iii) Labeling changes that delete misleading, false, or unsupported indications.

(iv) Changes in quality controls or manufacturing process that add a new specification or test method, or otherwise provide additional assurance of purity, identity, strength, or reliability of the device.

(e)(1) FDA will identify a change to a device for which an applicant has an approved PMA and for which a PMA supplement under paragraph (a) is not required. FDA will identify such a change in an advisory opinion under § 10.85, if the change applies to a generic type of device, or in correspondence to the applicant, if the change applies only to the applicant's device. FDA will require that a change for which a PMA supplement under paragraph (a) is not required be reported to FDA in:

(i) A periodic report under § 814.84 or

(ii) A 30-day PMA supplement under this paragraph.

(2) FDA will identify, in the advisory opinion or correspondence, the type of information that is to be included in the report or 30-day PMA supplement. If the change is required to be reported to FDA in a periodic report, the change may be made before it is reported to FDA. If the change is required to be reported in a 30-day PMA supplement, the change may be made 30 days after FDA files the 30-day PMA supplement unless FDA requires the PMA holder to provide additional information, informs the PMA holder that the supplement is not approvable, or disapproves

**Food and Drug Administration, HHS****§ 814.42**

the supplement. The 30-day PMA supplement shall follow the instructions in the correspondence or advisory opinion. Any 30-day PMA supplement that does not meet the requirements of the correspondence or advisory opinion will not be filed and, therefore, will not be deemed approved 30 days after receipt.

(f) Under section 515(d) of the act, modifications to manufacturing procedures or methods of manufacture that affect the safety and effectiveness of a device subject to an approved PMA do not require submission of a PMA supplement under paragraph (a) of this section and are eligible to be the subject of a 30-day notice. A 30-day notice shall describe in detail the change, summarize the data or information supporting the change, and state that the change has been made in accordance with the requirements of part 820 of this chapter. The manufacturer may distribute the device 30 days after the date on which FDA receives the 30-day notice, unless FDA notifies the applicant within 30 days from receipt of the notice that the notice is not adequate. If the notice is not adequate, FDA shall inform the applicant in writing that a 135-day PMA supplement is needed and shall describe what further information or action is required for acceptance of such change. The number of days under review as a 30-day notice shall be deducted from the 135-day PMA supplement review period if the notice meets appropriate content requirements for a PMA supplement.

[51 FR 26364, July 22, 1986, as amended at 51 FR 43344, Dec. 2, 1986; 63 FR 54044, Oct. 8, 1998; 67 FR 9587, Mar. 4, 2002; 69 FR 11313, Mar. 10, 2004]

**Subpart C—FDA Action on a PMA****§ 814.40 Time frames for reviewing a PMA.**

Within 180 days after receipt of an application that is accepted for filing and to which the applicant does not submit a major amendment, FDA will review the PMA and, after receiving the report and recommendation of the appropriate FDA advisory committee, send the applicant an approval order under § 814.44(d), an approvable letter under § 814.44(e), a not approvable letter

under § 814.44(f), or an order denying approval under § 814.45. The approvable letter and the not approvable letter will provide an opportunity for the applicant to amend or withdraw the application, or to consider the letter to be a denial of approval of the PMA under § 814.45 and to request administrative review under section 515 (d)(3) and (g) of the act.

**§ 814.42 Filing a PMA.**

(a) The filing of an application means that FDA has made a threshold determination that the application is sufficiently complete to permit a substantive review. Within 45 days after a PMA is received by FDA, the agency will notify the applicant whether the application has been filed.

(b) If FDA does not find that any of the reasons in paragraph (e) of this section for refusing to file the PMA applies, the agency will file the PMA and will notify the applicant in writing of the filing. The notice will include the PMA reference number and the date FDA filed the PMA. The date of filing is the date that a PMA accepted for filing was received by the agency. The 180-day period for review of a PMA starts on the date of filing.

(c) If FDA refuses to file a PMA, the agency will notify the applicant of the reasons for the refusal. This notice will identify the deficiencies in the application that prevent filing and will include the PMA reference number.

(d) If FDA refuses to file the PMA, the applicant may:

(1) Resubmit the PMA with additional information necessary to comply with the requirements of section 515(c)(1) (A)–(G) of the act and § 814.20. A resubmitted PMA shall include the PMA reference number of the original submission. If the resubmitted PMA is accepted for filing, the date of filing is the date FDA receives the resubmission;

(2) Request in writing within 10 working days of the date of receipt of the notice refusing to file the PMA, an informal conference with the Director of the Office of Device Evaluation to review FDA's decision not to file the PMA. FDA will hold the informal conference within 10 working days of its receipt of the request and will render

**§ 814.44****21 CFR Ch. I (4–1–05 Edition)**

its decision on filing within 5 working days after the informal conference. If, after the informal conference, FDA accepts the PMA for filing, the date of filing will be the date of the decision to accept the PMA for filing. If FDA does not reverse its decision not to file the PMA, the applicant may request reconsideration of the decision from the Director of the Center for Devices and Radiological Health. The Director's decision will constitute final administrative action for the purpose of judicial review.

(e) FDA may refuse to file a PMA if any of the following applies:

(1) The application is incomplete because it does not on its face contain all the information required under section 515(c)(1) (A)–(G) of the act;

(2) The PMA does not contain each of the items required under § 814.20 and justification for omission of any item is inadequate;

(3) The applicant has a pending pre-market notification under section 510(k) of the act with respect to the same device, and FDA has not determined whether the device falls within the scope of § 814.1(c).

(4) The PMA contains a false statement of material fact.

(5) The PMA is not accompanied by a statement of either certification or disclosure as required by part 54 of this chapter.

[51 FR 26364, July 22, 1986, as amended at 63 FR 5254, Feb. 2, 1998]

**§ 814.44 Procedures for review of a PMA.**

(a) FDA will begin substantive review of a PMA after the PMA is accepted for filing under § 814.42. FDA may refer the PMA to a panel on its own initiative, and will do so upon request of an applicant, unless FDA determines that the application substantially duplicates information previously reviewed by a panel. If FDA refers an application to a panel, FDA will forward the PMA, or relevant portions thereof, to each member of the appropriate FDA panel for review. During the review process, FDA may communicate with the applicant as set forth under § 814.37(b), or with a panel to respond to questions that may be posed by panel members or to provide additional information to

the panel. FDA will maintain a record of all communications with the applicant and with the panel.

(b) The advisory committee shall submit a report to FDA which includes the committee's recommendation and the basis for such recommendation on the PMA. Before submission of this report, the committee shall hold a public meeting to review the PMA in accordance with part 14. This meeting may be held by a telephone conference under § 14.22(g). The advisory committee report and recommendation may be in the form of a meeting transcript signed by the chairperson of the committee.

(c) FDA will complete its review of the PMA and the advisory committee report and recommendation and, within the later of 180 days from the date of filing of the PMA under § 814.42 or the number of days after the date of filing as determined under § 814.37(c), issue an approval order under paragraph (d) of this section, an approvable letter under paragraph (e) of this section, a not approvable letter under paragraph (f) of this section, or an order denying approval of the application under § 814.45(a).

(d)(1) FDA will issue to the applicant an order approving a PMA if none of the reasons in § 814.45 for denying approval of the application applies. FDA will approve an application on the basis of draft final labeling if the only deficiencies in the application concern editorial or similar minor deficiencies in the draft final labeling. Such approval will be conditioned upon the applicant incorporating the specified labeling changes exactly as directed and upon the applicant submitting to FDA a copy of the final printed labeling before marketing. FDA will also give the public notice of the order, including notice of and opportunity for any interested persons to request review under section 515(d)(3) of the act. The notice of approval will be placed on FDA's home page on the Internet (<http://www.fda.gov>), and it will state that a detailed summary of information respecting the safety and effectiveness of the device, which was the basis for the order approving the PMA, including information about any adverse effects of the device on health, is available on the Internet and has been

## Food and Drug Administration, HHS

## § 814.45

placed on public display, and that copies are available upon request. FDA will publish in the FEDERAL REGISTER after each quarter a list of the approvals announced in that quarter. When a notice of approval is published, data and information in the PMA file will be available for public disclosure in accordance with § 814.9.

(2) A request for copies of the current PMA approvals and denials document and for copies of summaries of safety and effectiveness shall be sent in writing to the Division of Dockets Management (HFA-305), Food and Drug Administration, 5630 Fishers Lane, rm. 1061, Rockville, MD 20852.

(e) FDA will send the applicant an approvable letter if the application substantially meets the requirements of this part and the agency believes it can approve the application if specific additional information is submitted or specific conditions are agreed to by the applicant.

(1) The approvable letter will describe the information FDA requires to be provided by the applicant or the conditions the applicant is required to meet to obtain approval. For example, FDA may require, as a condition to approval:

(i) The submission of certain information identified in the approvable letter, e.g., final labeling;

(ii) An FDA inspection that finds the manufacturing facilities, methods, and controls in compliance with part 820 and, if applicable, that verifies records pertinent to the PMA;

(iii) Restrictions imposed on the device under section 515(d)(1)(B)(ii) or 520(e) of the act;

(iv) Postapproval requirements as described in subpart E of this part.

(2) In response to an approvable letter the applicant may:

(i) Amend the PMA as requested in the approvable letter; or

(ii) Consider the approvable letter to be a denial of approval of the PMA under § 814.45 and request administrative review under section 515(d)(3) of the act by filing a petition in the form of a petition for reconsideration under § 10.33; or

(iii) Withdraw the PMA.

(f) FDA will send the applicant a not approvable letter if the agency believes

that the application may not be approved for one or more of the reasons given in § 814.45(a). The not approvable letter will describe the deficiencies in the application, including each applicable ground for denial under section 515(d)(2) (A)–(E) of the act, and, where practical, will identify measures required to place the PMA in approvable form. In response to a not approvable letter, the applicant may:

(1) Amend the PMA as requested in the not approvable letter (such an amendment will be considered a major amendment under § 814.37(c)(1)); or

(2) Consider the not approvable letter to be a denial of approval of the PMA under § 814.45 and request administrative review under section 515(d)(3) of the act by filing a petition in the form of a petition for reconsideration under § 10.33; or

(3) Withdraw the PMA.

(g) FDA will consider a PMA to have been withdrawn voluntarily if:

(1) The applicant fails to respond in writing to a written request for an amendment within 180 days after the date FDA issues such request;

(2) The applicant fails to respond in writing to an approvable or not approvable letter within 180 days after the date FDA issues such letter; or

(3) The applicant submits a written notice to FDA that the PMA has been withdrawn.

[51 FR 26364, July 22, 1986, as amended at 57 FR 58403, Dec. 10, 1992; 63 FR 4572, Jan. 30, 1998]

#### § 814.45 Denial of approval of a PMA.

(a) FDA may issue an order denying approval of a PMA if the applicant fails to follow the requirements of this part or if, upon the basis of the information submitted in the PMA or any other information before the agency, FDA determines that any of the grounds for denying approval of a PMA specified in section 515(d)(2) (A)–(E) of the act applies. In addition, FDA may deny approval of a PMA for any of the following reasons:

(1) The PMA contains a false statement of material fact;

(2) The device's proposed labeling does not comply with the requirements in part 801 or part 809;

**§ 814.46****21 CFR Ch. I (4-1-05 Edition)**

(3) The applicant does not permit an authorized FDA employee an opportunity to inspect at a reasonable time and in a reasonable manner the facilities, controls, and to have access to and to copy and verify all records pertinent to the application;

(4) A nonclinical laboratory study that is described in the PMA and that is essential to show that the device is safe for use under the conditions prescribed, recommended, or suggested in its proposed labeling, was not conducted in compliance with the good laboratory practice regulations in part 58 and no reason for the noncompliance is provided or, if it is, the differences between the practices used in conducting the study and the good laboratory practice regulations do not support the validity of the study; or

(5) Any clinical investigation involving human subjects described in the PMA, subject to the institutional review board regulations in part 56 or informed consent regulations in part 50, was not conducted in compliance with those regulations such that the rights or safety of human subjects were not adequately protected.

(b) FDA will issue any order denying approval of the PMA in accordance with § 814.17. The order will inform the applicant of the deficiencies in the PMA, including each applicable ground for denial under section 515(d)(2) of the act and the regulations under this part, and, where practical, will identify measures required to place the PMA in approvable form. The order will include a notice of an opportunity to request review under section 515(d)(3) of the act.

(c) FDA will use the criteria specified in § 860.7 to determine the safety and effectiveness of a device in deciding whether to approve or deny approval of a PMA. FDA may use information other than that submitted by the applicant in making such determination.

(d)(1) FDA will give the public notice of an order denying approval of the PMA. The notice will be placed on the FDA's home page on the Internet (<http://www.fda.gov>), and it will state that a detailed summary of information respecting the safety and effectiveness of the device, including information about any adverse effects of the

device on health, is available on the Internet and has been placed on public display and that copies are available upon request. FDA will publish in the FEDERAL REGISTER after each quarter a list of the denials announced in that quarter. When a notice of denial of approval is made publicly available, data and information in the PMA file will be available for public disclosure in accordance with § 814.9.

(2) A request for copies of the current PMA approvals and denials document and copies of summaries of safety and effectiveness shall be sent in writing to the Freedom of Information Staff (HFI-35), Food and Drug Administration, 5600 Fishers Lane, Rockville, MD 20857.

(e) FDA will issue an order denying approval of a PMA after an approvable or not approvable letter has been sent and the applicant:

(1) Submits a requested amendment but any ground for denying approval of the application under section 515(d)(2) of the act still applies; or

(2) Notifies FDA in writing that the requested amendment will not be submitted; or

(3) Petitions for review under section 515(d)(3) of the act by filing a petition in the form of a petition for reconsideration under § 10.33.

[51 FR 26364, July 22, 1986, as amended at 63 FR 4572, Jan. 30, 1998]

**§ 814.46 Withdrawal of approval of a PMA.**

(a) FDA may issue an order withdrawing approval of a PMA if, from any information available to the agency, FDA determines that:

(1) Any of the grounds under section 515(e)(1) (A)-(G) of the act applies.

(2) Any postapproval requirement imposed by the PMA approval order or by regulation has not been met.

(3) A nonclinical laboratory study that is described in the PMA and that is essential to show that the device is safe for use under the conditions prescribed, recommended, or suggested in its proposed labeling, was not conducted in compliance with the good laboratory practice regulations in part 58 and no reason for the noncompliance is provided or, if it is, the differences

## Food and Drug Administration, HHS

## § 814.47

between the practices used in conducting the study and the good laboratory practice regulations do not support the validity of the study.

(4) Any clinical investigation involving human subjects described in the PMA, subject to the institutional review board regulations in part 56 or informed consent regulations in part 50, was not conducted in compliance with those regulations such that the rights or safety of human subjects were not adequately protected.

(b)(1) FDA may seek advice on scientific matters from any appropriate FDA advisory committee in deciding whether to withdraw approval of a PMA.

(2) FDA may use information other than that submitted by the applicant in deciding whether to withdraw approval of a PMA.

(c) Before issuing an order withdrawing approval of a PMA, FDA will issue the holder of the approved application a notice of opportunity for an informal hearing under part 16.

(d) If the applicant does not request a hearing or if after the part 16 hearing is held the agency decides to proceed with the withdrawal, FDA will issue to the holder of the approved application an order withdrawing approval of the application. The order will be issued under § 814.17, will state each ground for withdrawing approval, and will include a notice of an opportunity for administrative review under section 515(e)(2) of the act.

(e) FDA will give the public notice of an order withdrawing approval of a PMA. The notice will be published in the FEDERAL REGISTER and will state that a detailed summary of information respecting the safety and effectiveness of the device, including information about any adverse effects of the device on health, has been placed on public display and that copies are available upon request. When a notice of withdrawal of approval is published, data and information in the PMA file will be available for public disclosure in accordance with § 814.9.

**§ 814.47 Temporary suspension of approval of a PMA.**

(a) *Scope.* (1) This section describes the procedures that FDA will follow in

exercising its authority under section 515(e)(3) of the act (21 U.S.C. 360e(e)(3)). This authority applies to the original PMA, as well as any PMA supplement(s), for a medical device.

(2) FDA will issue an order temporarily suspending approval of a PMA if FDA determines that there is a reasonable probability that continued distribution of the device would cause serious, adverse health consequences or death.

(b) *Regulatory hearing.* (1) If FDA believes that there is a reasonable probability that the continued distribution of a device subject to an approved PMA would cause serious, adverse health consequences or death, FDA may initiate and conduct a regulatory hearing to determine whether to issue an order temporarily suspending approval of the PMA.

(2) Any regulatory hearing to determine whether to issue an order temporarily suspending approval of a PMA shall be initiated and conducted by FDA pursuant to part 16 of this chapter. If FDA believes that immediate action to remove a dangerous device from the market is necessary to protect the public health, the agency may, in accordance with § 16.60(h) of this chapter, waive, suspend, or modify any part 16 procedure pursuant to § 10.19 of this chapter.

(3) FDA shall deem the PMA holder's failure to request a hearing within the timeframe specified by FDA in the notice of opportunity for hearing to be a waiver.

(c) *Temporary suspension order.* If the PMA holder does not request a regulatory hearing or if, after the hearing, and after consideration of the administrative record of the hearing, FDA determines that there is a reasonable probability that the continued distribution of a device under an approved PMA would cause serious, adverse health consequences or death, the agency shall, under the authority of section 515(e)(3) of the act, issue an order to the PMA holder temporarily suspending approval of the PMA.

(d) *Permanent withdrawal of approval of the PMA.* If FDA issues an order temporarily suspending approval of a PMA, the agency shall proceed expeditiously, but within 60 days, to hold a hearing on



**§ 814.80**

whether to permanently withdraw approval of the PMA in accordance with section 515(e)(1) of the act and the procedures set out in § 814.46.

[61 FR 15190, Apr. 5, 1996]

**Subpart D—Administrative Review  
[Reserved]**

**Subpart E—Postapproval  
Requirements**

**§ 814.80 General.**

A device may not be manufactured, packaged, stored, labeled, distributed, or advertised in a manner that is inconsistent with any conditions to approval specified in the PMA approval order for the device.

**§ 814.82 Postapproval requirements.**

(a) FDA may impose postapproval requirements in a PMA approval order or by regulation at the time of approval of the PMA or by regulation subsequent to approval. Postapproval requirements may include as a condition to approval of the device:

(1) Restriction of the sale, distribution, or use of the device as provided by section 515(d)(1)(B)(ii) or 520(e) of the act.

(2) Continuing evaluation and periodic reporting on the safety, effectiveness, and reliability of the device for its intended use. FDA will state in the PMA approval order the reason or purpose for such requirement and the number of patients to be evaluated and the reports required to be submitted.

(3) Prominent display in the labeling of a device and in the advertising of any restricted device of warnings, hazards, or precautions important for the device's safe and effective use, including patient information, e.g., information provided to the patient on alternative modes of therapy and on risks and benefits associated with the use of the device.

(4) Inclusion of identification codes on the device or its labeling, or in the case of an implant, on cards given to patients if necessary to protect the public health.

(5) Maintenance of records that will enable the applicant to submit to FDA information needed to trace patients if

**21 CFR Ch. I (4–1–05 Edition)**

such information is necessary to protect the public health. Under section 519(a)(4) of the act, FDA will require that the identity of any patient be disclosed in records maintained under this paragraph only to the extent required for the medical welfare of the individual, to determine the safety or effectiveness of the device, or to verify a record, report, or information submitted to the agency.

(6) Maintenance of records for specified periods of time and organization and indexing of records into identifiable files to enable FDA to determine whether there is reasonable assurance of the continued safety and effectiveness of the device.

(7) Submission to FDA at intervals specified in the approval order of periodic reports containing the information required by § 814.84(b).

(8) Batch testing of the device.

(9) Such other requirements as FDA determines are necessary to provide reasonable assurance, or continued reasonable assurance, of the safety and effectiveness of the device.

(b) An applicant shall grant to FDA access to any records and reports required under the provisions of this part, and shall permit authorized FDA employees to copy and verify such records and reports and to inspect at a reasonable time and in a reasonable manner all manufacturing facilities to verify that the device is being manufactured, stored, labeled, and shipped under approved conditions.

(c) Failure to comply with any postapproval requirement constitutes a ground for withdrawal of approval of a PMA.

(Approved by the Office of Management and Budget under control number 0910-0231)

[51 FR 26364, July 22, 1986, as amended at 51 FR 43344, Dec. 2, 1986]

**§ 814.84 Reports.**

(a) The holder of an approved PMA shall comply with the requirements of part 803 and with any other requirements applicable to the device by other regulations in this subchapter or by order approving the device.

(b) Unless FDA specifies otherwise, any periodic report shall:

**§ 860.7****21 CFR Ch. I (4-1-05 Edition)**

(2) The fact of the existence of a petition for reclassification filed in accordance with § 860.134 or § 860.136 is available for public disclosure at the time the petition is received by the Food and Drug Administration. The contents of such a petition are not available for public disclosure for the period of time following its receipt (not longer than 30 days) during which the petition is reviewed for any deficiencies preventing the Commissioner from making a decision on it. Once it is determined that the petition contains no deficiencies preventing the Commissioner from making a decision on it, the petition will be filed with the Division of Dockets Management and its entire contents will be available for public disclosure and subject to consideration by classification panels and by the Commissioner in making a decision on the petition. If, during this 30-day period of time, the petition is found to contain deficiencies that prevent the Commissioner from making a decision on it, the petitioner will be so notified and afforded an opportunity to correct the deficiencies.

Thirty days after notice to the petitioner of deficiencies in the petition, the contents of the petition will be available for public disclosure unless, within that 30 days, the petitioner submits supplemental material intended to correct the deficiencies in the petition. The Commissioner, in the Commissioner's discretion, may allow withdrawal of a deficient petition during the 30-day period provided for correcting deficiencies. Any supplemental material submitted by the petitioner, together with the material in the original petition, is considered as a new petition. The new petition is reviewed for deficiencies in the same manner as the original petition, and the same procedures for notification and correction of deficiencies are followed. Once the petitioner has corrected the deficiencies, the entire contents of the petition will be available for public disclosure and subject to consideration by classification panels and by the Commissioner in making a decision on the petition. Deficient petitions which have not been corrected within 180 days after notification of deficiency will be returned to

the petitioner and will not be considered further unless resubmitted.

(e) The Commissioner may not disclose, or use as the basis for reclassification of a device from class III to class II, any information reported to or otherwise obtained by the Commissioner under section 513, 514, 515, 516, 518, 519, 520(f), 520(g), or 704 of the act that falls within the exemption described in § 20.61 of this chapter for trade secrets and confidential commercial information. The exemption described in § 20.61 does not apply to data or information contained in a petition for reclassification submitted in accordance with § 860.130 or § 860.132, or in a petition submitted in accordance with § 860.134 or § 860.136 that has been determined to contain no deficiencies that prevent the Commissioner from making a decision on it. Accordingly, all data and information contained in such petitions may be disclosed by the Commissioner and used as the basis for reclassification of a device from class III to class II.

(f) For purposes of this section, safety and effectiveness data include data and results derived from all studies and tests of a device on animals and humans and from all studies and tests of the device itself intended to establish or determine its safety and effectiveness.

**§ 860.7 Determination of safety and effectiveness.**

(a) The classification panels, in reviewing evidence concerning the safety and effectiveness of a device and in preparing advice to the Commissioner, and the Commissioner, in making determinations concerning the safety and effectiveness of a device, will apply the rules in this section.

(b) In determining the safety and effectiveness of a device for purposes of classification, establishment of performance standards for class II devices, and premarket approval of class III devices, the Commissioner and the classification panels will consider the following, among other relevant factors:

(1) The persons for whose use the device is represented or intended;

(2) The conditions of use for the device, including conditions of use prescribed, recommended, or suggested in

## Food and Drug Administration, HHS

## § 860.7

the labeling or advertising of the device, and other intended conditions of use;

(3) The probable benefit to health from the use of the device weighed against any probable injury or illness from such use; and

(4) The reliability of the device.

(c)(1) Although the manufacturer may submit any form of evidence to the Food and Drug Administration in an attempt to substantiate the safety and effectiveness of a device, the agency relies upon only valid scientific evidence to determine whether there is reasonable assurance that the device is safe and effective. After considering the nature of the device and the rules in this section, the Commissioner will determine whether the evidence submitted or otherwise available to the Commissioner is valid scientific evidence for the purpose of determining the safety or effectiveness of a particular device and whether the available evidence, when taken as a whole, is adequate to support a determination that there is reasonable assurance that the device is safe and effective for its conditions of use.

(2) Valid scientific evidence is evidence from well-controlled investigations, partially controlled studies, studies and objective trials without matched controls, well-documented case histories conducted by qualified experts, and reports of significant human experience with a marketed device, from which it can fairly and responsibly be concluded by qualified experts that there is reasonable assurance of the safety and effectiveness of a device under its conditions of use. The evidence required may vary according to the characteristics of the device, its conditions of use, the existence and adequacy of warnings and other restrictions, and the extent of experience with its use. Isolated case reports, random experience, reports lacking sufficient details to permit scientific evaluation, and unsubstantiated opinions are not regarded as valid scientific evidence to show safety or effectiveness. Such information may be considered, however, in identifying a device the safety and effectiveness of which is questionable.

(d)(1) There is reasonable assurance that a device is safe when it can be determined, based upon valid scientific evidence, that the probable benefits to health from use of the device for its intended uses and conditions of use, when accompanied by adequate directions and warnings against unsafe use, outweigh any probable risks. The valid scientific evidence used to determine the safety of a device shall adequately demonstrate the absence of unreasonable risk of illness or injury associated with the use of the device for its intended uses and conditions of use.

(2) Among the types of evidence that may be required, when appropriate, to determine that there is reasonable assurance that a device is safe are investigations using laboratory animals, investigations involving human subjects, and nonclinical investigations including in vitro studies.

(e)(1) There is reasonable assurance that a device is effective when it can be determined, based upon valid scientific evidence, that in a significant portion of the target population, the use of the device for its intended uses and conditions of use, when accompanied by adequate directions for use and warnings against unsafe use, will provide clinically significant results.

(2) The valid scientific evidence used to determine the effectiveness of a device shall consist principally of well-controlled investigations, as defined in paragraph (f) of this section, unless the Commissioner authorizes reliance upon other valid scientific evidence which the Commissioner has determined is sufficient evidence from which to determine the effectiveness of a device, even in the absence of well-controlled investigations. The Commissioner may make such a determination where the requirement of well-controlled investigations in paragraph (f) of this section is not reasonably applicable to the device.

(f) The following principles have been developed over a period of years and are recognized by the scientific community as the essentials of a well-controlled clinical investigation. They provide the basis for the Commissioner's determination whether there is reasonable assurance that a device is

## § 860.7

## 21 CFR Ch. I (4-1-05 Edition)

effective based upon well-controlled investigations and are also useful in assessing the weight to be given to other valid scientific evidence permitted under this section.

(1) The plan or protocol for the study and the report of the results of a well-controlled investigation shall include the following:

(i) A clear statement of the objectives of the study;

(ii) A method of selection of the subjects that:

(a) Provides adequate assurance that the subjects are suitable for the purposes of the study, provides diagnostic criteria of the condition to be treated or diagnosed, provides confirmatory laboratory tests where appropriate and, in the case of a device to prevent a disease or condition, provides evidence of susceptibility and exposure to the condition against which prophylaxis is desired;

(b) Assigns the subjects to test groups, if used, in such a way as to minimize any possible bias;

(c) Assures comparability between test groups and any control groups of pertinent variables such as sex, severity or duration of the disease, and use of therapy other than the test device;

(iii) An explanation of the methods of observation and recording of results utilized, including the variables measured, quantitation, assessment of any subject's response, and steps taken to minimize any possible bias of subjects and observers;

(iv) A comparison of the results of treatment or diagnosis with a control in such a fashion as to permit quantitative evaluation. The precise nature of the control must be specified and an explanation provided of the methods employed to minimize any possible bias of the observers and analysts of the data. Level and methods of "blinding," if appropriate and used, are to be documented. Generally, four types of comparisons are recognized:

(a) *No treatments.* Where objective measurements of effectiveness are available and placebo effect is negligible, comparison of the objective results in comparable groups of treated and untreated patients;

(b) *Placebo control.* Where there may be a placebo effect with the use of a de-

vice, comparison of the results of use of the device with an ineffective device used under conditions designed to resemble the conditions of use under investigation as far as possible;

(c) *Active treatment control.* Where an effective regimen of therapy may be used for comparison, e.g., the condition being treated is such that the use of a placebo or the withholding of treatment would be inappropriate or contrary to the interest of the patient;

(d) *Historical control.* In certain circumstances, such as those involving diseases with high and predictable mortality or signs and symptoms of predictable duration or severity, or in the case of prophylaxis where morbidity is predictable, the results of use of the device may be compared quantitatively with prior experience historically derived from the adequately documented natural history of the disease or condition in comparable patients or populations who received no treatment or who followed an established effective regimen (therapeutic, diagnostic, prophylactic).

(v) A summary of the methods of analysis and an evaluation of the data derived from the study, including any appropriate statistical methods utilized.

(2) To insure the reliability of the results of an investigation, a well-controlled investigation shall involve the use of a test device that is standardized in its composition or design and performance.

(g)(1) It is the responsibility of each manufacturer and importer of a device to assure that adequate, valid scientific evidence exists, and to furnish such evidence to the Food and Drug Administration to provide reasonable assurance that the device is safe and effective for its intended uses and conditions of use. The failure of a manufacturer or importer of a device to present to the Food and Drug Administration adequate, valid scientific evidence showing that there is reasonable assurance of the safety and effectiveness of the device, if regulated by general controls alone, or by general controls and performance standards, may support a determination that the device be classified into class III.

## Food and Drug Administration, HHS

## § 860.84

(2) The Commissioner may require that a manufacturer, importer, or distributor make reports or provide other information bearing on the classification of a device and indicating whether there is reasonable assurance of the safety and effectiveness of the device or whether it is adulterated or misbranded under the act.

(3) A requirement for a report or other information under this paragraph will comply with section 519 of the act. Accordingly, the requirement will state the reason or purpose for such request; will describe the required report or information as clearly as possible; will not be imposed on a manufacturer, importer, or distributor of a classified device that has been exempted from such a requirement in accordance with § 860.95; will prescribe the time for compliance with the requirement; and will prescribe the form and manner in which the report or information is to be provided.

(4) Required information that has been submitted previously to the Center for Devices and Radiological Health need not be resubmitted, but may be incorporated by reference.

[43 FR 32993, July 28, 1978, as amended at 53 FR 11253, Apr. 6, 1988]

## Subpart B—Classification

## § 860.84 Classification procedures for "old devices."

(a) This subpart sets forth the procedures for the original classification of a device that either was in commercial distribution before May 28, 1976, or is substantially equivalent to a device that was in commercial distribution before that date. Such a device will be classified by regulation into either class I (general controls), class II (special controls) or class III (premarket approval), depending upon the level of regulatory control required to provide reasonable assurance of the safety and effectiveness of the device (§ 860.3(c)). This subpart does not apply to a device that is classified into class III by statute under section 513(f) of the act because the Food and Drug Administration has determined that the device is not "substantially equivalent" to any device subject to this subpart or under section 520(l) (1) through (3) of the act

because the device was regarded previously as a new drug. In classifying a device under this section, the Food and Drug Administration will follow the procedures described in paragraphs (b) through (g) of this section.

(b) The Commissioner refers the device to the appropriate classification panel organized and operated in accordance with section 513 (b) and (c) of the act and part 14 of this chapter.

(c) In order to make recommendations to the Commissioner on the class of regulatory control (class I, class II, or class III) appropriate for the device, the panel reviews the device for safety and effectiveness. In so doing, the panel:

(1) Considers the factors set forth in § 860.7 relating to the determination of safety and effectiveness;

(2) Determines the safety and effectiveness of the device on the basis of the types of scientific evidence set forth in § 860.7;

(3) Answers the questions in the classification questionnaire applicable to the device being classified;

(4) Completes a supplemental data sheet for the device;

(5) Provides, to the maximum extent practicable, an opportunity for interested persons to submit data and views on the classification of the device in accordance with part 14 of this chapter.

(d) Based upon its review of evidence of the safety and effectiveness of the device, and applying the definition of each class in § 860.3(c), the panel submits to the Commissioner a recommendation regarding the classification of the device. The recommendation will include:

(1) A summary of the reasons for the recommendation;

(2) A summary of the data upon which the recommendation is based, accompanied by references to the sources containing such data;

(3) An identification of the risks to health (if any) presented by the device;

(4) In the case of a recommendation for classification into class I, a recommendation as to whether the device should be exempted from the requirements of one or more of the following sections of the act: section 510 (registration, product listing, and premarket notification) section 519



---

---

APPENDIX D—INTERNAL FDA MEMORANDA

---

---

DEPARTMENT OF HEALTH AND HUMAN SERVICES

PMA-S Memo

Division of General and Restorative, and Neurological  
Devices  
General Surgery Devices Branch

Food and Drug Administration  
Office of Device Evaluation  
Center for Devices and Radiological Health  
9200 Corporate Boulevard  
Rockville, MD 20850

**Date:** 11/10/04  
**To:** The file  
**From:** Medical Officer  
**Subject:** Review of Cyberonics response to NA Letter  
P970003/S050

**PMA amendment P970003/S50**

In response to the not-approvable letter sent to Cyberonics in August of 2004 concerning their PMA-S to expand the indications for use of their Vagal Nerve Stimulator (VNS) to include patients with treatment resistant depression, the sponsor has submitted amendment. The sponsor has provided responses to each issue raised in the NA letter and these responses are as described below. The concerns raised in the letter are presented in bold, with a summary of the sponsor's response following each concern. My review comments then follow in italics.

**Safety:**

**“There are safety concerns associated with the use of your device, including know risks related to implantation or stimulation, including serious adverse events such as asystole/bradycardia and vocal cord paralysis.”**

In response to this concern the sponsor has provided a summary of the safety profile of the VNS device for its marketed use in intractable epilepsy. They additionally comment that the safety of the device was not raised as a concern during the panel meeting. Briefly, the sponsor noted the rates of the following serious adverse events:

Vocal cord paralysis - ~1% (5/454 subjects in the epilepsy studies, 3/342 in depression studies).

Asystole/bradycardia - 1-2/1000 implants. The sponsor does not provide a source for this estimation. They also state the cardiac events reported are often due to pre-implant medical condition. There is no supporting data presented for this generalization.

The following table shows a complete list of serious adverse events seen in the D02 study (acute phase):



SAE	Treatment n=119	Sham n=116
Suicide	1	0
Wound Infection	1	0
Asystole	1	0
Bradycardia	1	0
Cholecystitis	0	1
Dehydration	1	1
Myasthenia	0	1
Confusion	1	0
Depression	5	7
Abnormal Thinking	1	0
Vocal Cord Paralysis	0	1
Aspiration Pneumonia	1	0
Pneumonia	0	1
Voice Alteration	0	1
Device Site Reaction	2	0
Renal failure	0	1

*Comments: The sponsor has provided no new data to support the safety of the VNS therapy in TRD. While the rates of the mentioned serious adverse events are not significantly different than those seen in the epilepsy studies, they do represent a real risk to the patient, which must be considered in a risk/benefit assessment of the device. It is in the context of an inadequately defined benefit to the patient (due to failures of the study design as noted below) that the safety of the device is brought into question. Since there are serious adverse events related to the use of the device, it cannot be considered "safe" without a documented benefit to offset these risks.*

**"In addition to known safety concerns, worsening depression was reported as a serious adverse event during the long-term D02 study. Without comparison to a control population, we are unable to determine whether your device places patients at increased risk for this event."**

In response to this concern, the sponsor has summarized the cases of worsening depression from the acute phase of the study. In the D02 acute study, there were 7 cases of worsening depression (6%) in the sham group compared to 5 cases (4%) in the treatment group. However, since no safety data was collected in the D04 study, there are not data available for comparison for the long term phase. The sponsor suggests that hospitalization for psychiatric illness (which was collected for D04) is an adequate surrogate measure. The rate of hospitalization in D04 was 0.237 per patient-year vs 0.293 in the D02 long term phase. The sponsor has also provided new data showing that the rate of worsening depression is lower during the 2<sup>nd</sup> year of follow-up than during the first year. The incidence of worsening depression in the first 4 quarters of the 2 year follow-up

period was 6%, 8%, 6% and 7%. In the 2<sup>nd</sup> 4 quarters they were 4%, 3%, 3% and 3%. The total number of subjects also decreases with only 76% of subjects completing 2 year follow-up.

*Comments: The only new data presented in response to this concern are the adverse event reports for two year follow up patients. The incidence by quarter of worsening depression is numerically lower in the second year than in the first. However, given the 25% loss to follow-up rate no statistically valid comparisons can be made (nor were any attempted by the sponsor). In order to address the issue of patients lost to follow-up, the reasons for lost patients must be examined. Without specific data, it is reasonable to assume that patients with good response to treatment (and thus without worsening depression) would be more likely to continue to return for visits as opposed to patients with a poor experience with the device. Thus the decrease in the rate of the reporting of this event could be related to the loss of patients and not to a truly diminishing adverse event.*

*Due to the lack of safety data in a suitable control population, the long-term risk of worsening depression remains unknown for treatment with VNS.*

#### Effectiveness

**“A chief limitation of the long-term pivotal D02 clinical study, observational control D04 study comparative analysis was that the data were not derived from a randomized subject data set, but rather a comparison of outcomes from an investigational device study and observational control study.**

**As a result, our ability to make meaningful conclusions from the data you provided was affected by the following limitations:**

- a. Failure of the randomized, controlled pivotal D02 acute study to reach its primary efficacy endpoint.”**

The sponsor provided a summary of the D02 acute phase results in response to this concern. They state that while the primary endpoint failed to show significance, there were other tests done that did show significance. These included a LOCF analysis of the IDS-SR at 5 weeks and 12 weeks. The sponsor asserts that these results support the effectiveness of the device.

*Comment: The sponsor ran numerous statistical tests on various secondary endpoints collected as part of the D02 acute study. The results of these numerous post-hoc analyses demonstrated 2 marginally significant tests. While the p-values provided by the sponsor were <0.05, these values have not been adjusted for multiple comparisons. Such exploratory data analysis techniques (data dredging) are viewed by the statistical literature as adequate only for generating hypotheses and not as demonstrating any reliable relationship. In a paper by Sankoh (1) on multiple tests in clinical trials, the authors recommend NOT employing corrections for multiple comparisons to these types of analyses since correction algorithms cannot successfully account for the large*

*increase in type I error associated with data dredging. The authors recommend that any relationship found during this type of analysis must be tested in another statistically sound study.*

- b. “Potential bias of a non-randomized data set in the long-term D02, D04 comparative analysis that could reasonably affect the clinical outcomes reported in your study.”**
- c. Potential bias of unmeasured patient variables in the long-term D02, D04 comparative analysis that could reasonably affect the clinical outcomes reported in your study.**
- d. Potential bias of unmasked ratings in the long-term D02, D04 comparative analysis that could reasonably affect the clinical outcomes reported in your study.**
- e. Potential bias of research centers having more interest in the treatment study (the pivotal D02 study) rather than the naturalistic, observational control study (the D04 control study) that could reasonably affect the clinical outcomes reported in your study.**
- f. Potential bias of patient expectation of participating in an investigational study for a new therapy versus the expectation of participating in an observational, control study that could reasonably affect the clinical outcomes reported in your study.**

The sponsor has provided no new information or data to answer these concerns. They have restated the arguments made at panel and in the PMA document.

*Comment: All of these potential biases exist in the D02/D04 comparison. The sponsor has provided no new data to address these issues. The long term (24 month) data is evaluated without a control group, but with references to other populations of patients from the literature (ECT for example) with various levels of depression. This comparison is confounded by all of the above biases in addition to numerous other biases associated to the use of a literature control in unmatched subjects. In particular, the impact of unmeasured patient variables remains a concern.*

*In the D02/D04 comparison, the sponsor identified 17 variables that were monitored. They state that analysis of these variables showed the groups were well matched. They also indicated that a propensity analysis showed that for selected variables where there were statistical differences between the two populations, that these differences were not likely to impact the outcome. Examination of the table listing the 17 measured variables (Table 4.1 in S050) reveals that 3 variables were statistically different between D02 and D04. These were race, lifetime ECT treatment and ECT treatment received for the*

current MDE. Additionally, the length of the current MDE, which while not statistically significant, was numerically much longer in the D04 study (68.6 months in D04 vs 49.9 in D02). Whether or not these variables impacted the results of the D02/D04 comparative analysis, this analysis certainly reveals that the two groups were not well matched for some important clinical variables. Therefore it is difficult to accept the generalization that other unmeasured variables will also be well matched. These demonstrated differences could be related to differences in the methods used by investigators to select patients for each arm of the study, or in the type of patient likely to agree to participate in either arm. Thus any bias interjected could also create differences in these other important (and unmeasured) co-variables.

The sponsor also suggests that other unmeasured variables (specifically presence of personality disorder) do not have an impact on treatment effect. They reference Mulder et al 2002, a review of the effect of specific personality traits and axis II diagnoses on outcomes in clinical trials of depression treatment. While this study does show that in well controlled, randomized trials with short outcome measures (6-12 weeks), there was no correlation between treatment effect and personality disorder, in almost all of the long term (12 month follow-up) studies referenced in the Mulder paper, the presence of high neuroticism was predictive of worse outcome. These conclusions demonstrate two important points. The first is the power of a randomized, controlled trial to better account for differences in co-variables and the second that the presence of certain personality traits can be predictive of worse outcome, and thus should be measured and controlled for particularly in longer-term studies.

The sponsors' response does not adequately answer the question of whether other unmeasured variables could have played a role in the differential outcome between the two compared populations. Thus, while there is no direct evidence that other co-variables are responsible for the observed difference between the treatment and observational control groups, the question as to whether other important variables, that were not controlled for or matched by study design could have impacted what is a slim statistical outcome remains open.

Finally, while the contribution of each of the listed biases (unmeasured variables, patient expectation, and unmasked ratings) may not account for the differences seen individually, each adds uncertainty to the final analysis and it is the additive effect of each of these concerns that prohibits us from accepting the D02/D04 comparison as demonstrating efficacy of the device.

**g. Inability to distinguish the improvement attributable to VNS therapy from the improvement attributable to a placebo response in the long-term D02, D04 comparative analysis.**

The sponsor has stated that a placebo response is unlikely to have caused the differences seen in the D02/D04 comparisons. They state that 1) the results of the acute phase of D02 demonstrate that the response was not placebo. 2) There was a high rate of sustained response in 3 and 12 month responders at 12 and 24 months; 3) The placebo response is well established to occur early in treatment and diminish; and 4) That the placebo

response is only 10% in TRD whereas the response rates in the long term D02 study was 22 or 37% depending on the scale.

*Comments 1, 3 and 4 are restatements of arguments made at panel and in the PMA-S. Only comment 2 references new information (not contained in the PMA, though it was presented at panel). To summarize my prior concerns regarding the placebo response:*

- 1) *The results of the D02 study do not demonstrate a difference between the treatment group and control group. The primary endpoint failed to reach significance, indicating that the small numerical differences between the two groups (a 5% difference in response) has a probability of occurring due to chance alone that is too high to consider this difference real. The results seen in the numerous secondary endpoint evaluations are also not statistically valid (see above comments under effectiveness question part a.). Therefore the D02 acute phase does not demonstrate a treatment response.*
- 2) *The sponsor claims that the high rate of sustained responders (24 month data) is evidence of a treatment response without the need for control group to compare to. There is no long term data published on patients with treatment resistant depression from which to generate this conclusion. However, a recent paper by Trivedi et al (2) examined patients with chronic depression (average length of disease 13 years) using an algorithm guided treatment (ALGO) to adjust patients medication. This was compared to a group that received treatment as usual. In this study the difference in mean IDS-SR score at 12 months between the two groups was 7.5 points. This demonstrates that simply changing the approach to medication (all patients and physicians had access to the same medications, only the approach to changes was different) can have an impact at 12 months similar to the differences seen between D02 and D04. The authors further explored subgroups of patients based on the severity of illness and found that the majority of the difference between ALGO and TAU were in the severe and very severely affected patients. This suggests that with medical management, such responses are possible in severely affected patients. Thus the sponsors claim that in this population a control is not needed is contradicted by the literature that demonstrates that improvement is seen with appropriate medical management and thus an appropriate control would be needed to determine the actual response due to VNS.*
- 3) *The sponsor continues to claim that the placebo response in depression occurs early and diminishes, despite evidence from their study (sham group of the acute phase of D02) that suggests the response is robust to 3 months. Since the sham group was crossed over at that point, no further information is available about the longer term durability of this placebo response. The sponsor has not provided any literature or data to support the claim that this clearly observed placebo response that was sustained to 3 months would not continue. The sponsor also references the paper by Quitkin FM et al. In that article, the authors examine the pattern of response to both placebo and drug therapy. In the paper, 7-10% of the patients in the placebo arm of the drug trial had a delayed onset of response that was persistent to 6 weeks (this was the pattern identified as the "treatment effect" pattern). Another 5-6% had an early onset response that was also persistent to 6*

*weeks (this was more consistent with a placebo response, due to the early onset, but was nonetheless a persistent response to the final follow-up visit). This data therefore shows that while a pattern of delayed-onset response that persists to 6 weeks was statistically better correlated with a treatment response than a placebo, a response that was persistent to the final follow-up visit (with either an early or delayed onset) was seen in up to 16% of patients in the placebo arm. Another 14% of the patients in the placebo arm had some fluctuation in their response throughout the study visits, but were classified as responders at the final visit. Only 11% of the patients in the placebo arm had an early onset effect that diminished by the final visit. This article therefore provides evidence contrary to the sponsor's claims that placebo effects characteristically occurs early in treatment and diminish rapidly, as more patients had a persistent effect than this "characteristic" pattern.*

- 4) *The responder rate seen in the sham D02 group (the actual placebo response rate) was 10%. The difference between the responder rate in D02 and D04 at 12 months follow-up was 22% vs. 12%, or 10%. The sponsor reports that the response rate to VNS was 22% or 37%, however it is the difference between the D02 and D04 response rates that are relevant and this difference is consistent with the magnitude of the observed placebo response rate. Therefore one can reasonably draw the conclusion that it is the placebo effect that accounts for the difference between the D02 and D04 subjects and not a treatment effect.*

- h. Inability to distinguish the improvement attributable to VNS therapy from the improvement attributable to concomitant antidepressant treatments in the long-term D02, D04 comparative analysis.**

*The sponsor has provided no new analyses of the impact of concomitant treatments on the outcomes of the D02 and D04 studies. The censored analysis in which data points derived from patients in D02 who had medication changes during the long term phase were excluded, and the last observation prior to the change was carried forward, did not show a statistical difference between the two populations.*

**“Because of all of the issues identified above, we do not believe the submitted clinical data are sufficient to demonstrate safety and effectiveness of your device. You should therefore provide clinical data from a new, scientifically sound, randomized, controlled study, which addresses concomitant treatment use and includes adequate safety assessments in both the treatment and control group”**

In response to this request for an additional, randomized study, the sponsor has made the following arguments (my comments are in italics):

- 1) The results of the D02 acute phase demonstrate that a longer term study is needed for VNS to work.

*The results of the D02 study demonstrate no benefit of VNS therapy. They do not specifically support a longer term for benefit. Results presented at panel demonstrated that response to VNS occurred early with only a small change between the 3 month and 12 month endpoints. The sponsor has not provided data demonstrating that VNS therapy required long-term treatment to be effective.*

2) A randomized controlled trial of longer than 3-4 months is unethical and not feasible.

*FDA has proposed alternative study designs, including a single arm study in which all enrolled patients are treated with VNS for 6 month, followed by a randomized phase in which half of the subjects have therapy withdrawn (turned off) and subjects are followed to a specified endpoint (3 months) or until they have complete regression of symptoms to pre-stimulation scores on depression rating scales. Such a design would allow for longer exposure to stimulation and eliminate the ethical issues since all patients are receiving therapy.*

3) An active control with one or a selection of other treatments would not be feasible due to the nature of the patients studied (already failed multiple treatments);

*On going drug studies of TRD include placebo controls which could be used as all patients enrolled would qualify for placebo. Additionally, in the published article by Trivedi et al, patients with chronic depression (average length of disease was 13 years) were selected for treatment with a specific medication algorithm that allowed for changes in medications. Such an algorithm could be used as an active control.*

4) A replication of the D02/D04 study but using a randomized design would not address 5 of the 8 limitations in the NA letter, specifically:

a) The failure of the D02 study to reach its primary endpoint,

*This would be directly addressed as the results of the new study would take the place of the D02 acute study as the pivotal trial.*

b) The potential bias of unmeasured patient variables

*Randomized controlled trials help to ensure adequate distribution of both measured and unmeasured variables. If a randomization scheme is successful at providing equal distribution of measured variables, it is safe to make assumptions about unmeasured variables. This is specifically the power gained by using a randomized design.*

c) The potential bias of unmasked ratings

*A study design utilizing low and high stimulation could be used to help mask patients to their treatment group.*

d) The inability to distinguish improvement due to VNS therapy from improvement due to placebo response.

*The ability to determine the difference between placebo and treatment response is tied to the ability to mask patients to their treatment group. Using low level stimulation in the control population is one option to limit this effect. A study design that incorporates a randomized withdrawal of therapy is less likely to incorporate placebo effects since the study will examine patients who have a sustained response to treatment at 6 months and then lose the treatment effect with a decrease or shutting off of stimulation.*

**Additional comparison to ECT population:**

The sponsor has provided an additional comparison of the long-term outcome of the D02 study to published results of a study of ECT use in patients with chronic and resistant depression (4). In this paper by Sackheim, there was an 80% (64/80) response rate at 1 week after randomized therapy. Response rate, however was defined as HRSD score of <16 and drop in HRSD of > 60% and the patient had to be off psychotropic medication. This is a far greater requirement than set in the D02 study (HRSD decrease of >50% only). The relapse rate in 62 of the 64 responders who were followed for 1 year was 53% (31/62). Thus the efficacy (responder rate) of ECT at one year was 31/80 or 38.8%. This is compared to a rate of 29.8% (54/181) at 1 year for the D02 study.

*Thus while the relapse rate in ECT was high (53%) compared to the relapse rate in D02 (closer to 30%), at one year, a higher proportion of the ECT patients were still responders compared to VNS (38.8% vs 29.8%). If the definition of responder used in the ECT study (noted above) was applied to the VNS results, the responder rate for VNS would have been even lower. Finally, these two populations of patients are quite different. While Sackheim does do a subset analysis looking only at medication resistant patients, the n for this analysis is very small (n=36) and thus it is difficult to draw any conclusions for these analyses.*

**Recommendation:** The concerns raised in the NA letter surrounded the inability to determine whether the treatment was efficacious due to weakness in the D02/D04 comparison. In response these concerns over a comparison between an investigational study and an observation control, the sponsor has provided long term follow-up data with no control group for comparison. Instead they suggest that the natural history of TRD is well know (while at the same time claiming it has not been well studied) and thus no control group is needed to evaluate the long term (24 month) results. They additionally provide reference to studies of ECT in the literature. This new data does not address our concerns over the study design. Therefore I recommend that this PMA is not approvable. To make the application approvable the sponsor should conduct and new, randomized, controlled trial.



Medical Officer  
DGNRD/GSDB

**References:**

- 1) Sankoh AJ, Huque MF, Dubey SD. Some comments on frequently used multiple endpoint adjustment methods in clinical trials. *Stat Med.* 1997 Nov 30;16(22):2529-42.
- 2) Trivedi, Madhukar H. MD; Rush, A. John MD; Crismon, M. Lynn PharmD; Kashner, T. Michael PhD, JD, MPH; Toprac, Marcia G. PhD; Carmody, Thomas J. PhD; Key, Tracie BSN, RN; Biggs, Melanie M. PhD; Shores-Wilson, Kathy PhD; Witte, Bradley BA; Suppes, Trisha MD, PhD; Miller, Alexander L. MD; Alshuler, Kenneth Z. MD; Shon, Steven P. MD. Clinical Results for Patients With Major Depressive Disorder in the Texas Medication Algorithm Project. *Archives of General Psychiatry.* 61(7):669-680, July 2004.
- 3) Quitkin FM, Rabkin JG, Ross D, Stewart JW. Identification of true drug response to antidepressants. Use of pattern analysis. *Arch Gen Psychiatry.* 1984 Aug;41(8):782-6.

COMPLETED OCT 22 2004

**REVIEW AND EVALUATION OF CLINICAL DATA****Consultative Comments**

<b>Submission</b>	PMA97003/S50
<b>Sponsor:</b>	Cyberonics
<b>Device:</b>	VNS™ Therapy System
<b>Indication:</b>	Treatment of Chronic or Recurrent Depression
<b>Dates of Consult Request:</b>	October 6, 2004
<b>Date Consult Received</b>	October 14, 2004
<b>Materials Reviewed:</b>	Sponsor's response to Not Approval Action Letter
<b>Consult requested by:</b>	Review Team Leader

**BACKGROUND:**

On August 11<sup>th</sup>, 2004, CDRH issued Cyberonics a not approvable letter for the VNS system in the treatment of treatment resistant depression (TRD). Over about the last year, the Division of Neuropharmacological Drug Products (DNDP) worked as a consultant to CDRH in review of the PMA for this indication. This consult request is seeking advice regarding the sponsor's claim that they need not present data from positive controlled trials because patients with TRD can not be expected to improve by chance.

Currently, the VNS Therapy System™ is available on the market and is approved for use as an adjunctive therapy in reducing the frequency of seizures in adults and adolescents over 12 years of age with anti-epileptic medication refractory partial onset seizures. Patients are currently able to receive VNS therapy for TRD on a compassionate use basis.

DNDP has consulted with HFZ-410 on this device and has consistently recommended that the sponsor needed to produce two positive controlled trials to gain approval for a claim of efficacy in the treatment of TRD. The sponsor has produced one failed short-term study and some open-label data in support of this claim. DNDP agrees that this is insufficient evidence to approve VNS for the treatment of TRD. DNDP has taken the position that VNS can not be approved for the treatment of TRD without positive controlled trial data. Our last consult outlined potential trial designs and suitable study populations for testing the VNS system.

HFZ-410 requests recommendations on the sponsors continuing discussion that patients with TRD could not be expected to improve by chance, based on the non-randomized, uncontrolled follow-up clinical data that the sponsor has provided in their submission amendment.

**Recommendations and Conclusion**

DNDP has commented in the past on the sponsor's argument that patients with TRD can not be expected to improve spontaneously. This additional information is of the same trial design that DNDP found unvaluable in the past. DNDP's position on the use of uncontrolled or historically controlled trial data in the evaluation of mood disorders in general and TRD specifically has not changed since we began consulting on this project.

It likewise does not appear that DNDP shall change that opinion as this is not a matter that is controversial in the psychiatric clinical trials research community.

In our previous consults, DNDP mentioned other TRD drug development programs that are currently underway. Sponsors of these programs appear to be enrolling and treating similar patient populations in protocols very similar to those we suggested in our previous consults for VNS. In the past, Cyberonics has argued that controlled trial data is not possible or ethical to collect. This current argument that open-label trial data is sufficient for approval is an extension of these previous arguments. While the sponsor no longer argues that these studies are either unethical or impossible to perform, they continue to submit open-label data as a basis for approval. I maintain that controlled trial data must be acquired because it would be unethical not to do so. Historically psychiatric patients have suffered long years of ineffective costly and invasive treatments such as frontal lobotomy for any number of conditions and psychoanalysis for schizophrenia based on open-trial or case-study information. Cyberonics argument that open label data is sufficient for approval is poorly supported by science and history.

DNDP previously found that the Cyberonics argument that patients with TRD predictably did not improve spontaneously was without merit based on the short-term trial data that they presented. These data showed that there was an indistinguishable yet positive treatment response in both the sham and VNS groups. The VNS short-term data showed that there was not a lack of improvement in the study over its duration but, there was a lack of detectable treatment difference between the sham condition and the active VNS. TRD sham patients showed spontaneous improvement by the sponsor's own short-term controlled trial data presentation. This is actually expected and it is seen in most studies of major depression.

Cyberonics argues that patients enrolled in studies of Major Depressive Disorder are not comparable to TRD patients. This is not necessarily true. Since many treatments are available for depression, patients who now enroll in drug studies for Major Depressive Disorder have often failed one or more standard treatments. Therefore the larger clinical trial experience with "non-TRD" studies is likely applicable to patients that Cyberonics wishes to distinguish as fundamentally different. This larger experience argues strongly for the necessity of controlled trial data as a basis for drug approval.

This submission is an incomplete response to the not approval letter. In my opinion this submission should not be considered an adequate response that provides appropriate data for review. It lacks positive controlled trial data that is absolutely necessary to support the approval of a treatment for TRD. This opinion that controlled trial data is necessary is based on previous in-house expert review of the VNS program, experience in reviewing ongoing development programs for TRD and peer reviewed literature that is cited in our previous communications with

Psychopharmacology Team Leader  
DNDP



## DEPARTMENT OF HEALTH &amp; HUMAN SERVICES

Public Health Service

## MEMORANDUM

Food and Drug Administration  
1350 Piccard Drive  
Rockville, MD 20850

Date: November 8, 2004

To: Lead Reviewer, ODE/DGRND/RDB  
, Branch Chief, ODE/DGRND/RDB  
, Medical Officer, ODE/DGRND/GSDB  
, Division Director, ODE/DGRND

From: , Biologist, Product Evaluation Branch (PEB) II  
Division of Postmarket Surveillance (DPS), OSB

Subject: Cyberonics Adverse Event Report Review

Through: , Branch Chief, PEB II, DPS, OSB  
, Deputy Director, DPS, OSB

### Purpose

The purpose of this memo is to present an analysis of reports on adverse events associated with the Vagal Nerve Stimulator (VNS) manufactured by Cyberonics, Inc. The Office of Device Evaluation requested a detailed analysis to summarize the marketed experience with the VNS to date. The analysis covers the time period from the last 5-year mortality report, July 1, 2002 through October 8, 2004.

### Methods

The Manufacturer and User Facility Device Experience (MAUDE) adverse event reports database was queried using product code LYJ and the firm name Cyberonics. The MAUDE search generated 1,887 reports involving 1,887 patients. All death and injury reports were reviewed individually. Injury reports were reviewed and categorized into different patient problem areas. Malfunctions were reviewed based on patient and device problem codes. The one figure presented represents reports by year of event. The numbers in the figure are not equal to numbers quoted in the text since many reports do not note date of event.

## Results

The 1,887 patient events included 314 deaths, 1,148 injuries, 425 malfunctions. The reporting sources included: 1,870 manufacturer, 10 voluntary reporters, and 7 user facilities. Of the 1,887 patients, 1,663 were treated in the United States and 90 were treated outside the U.S. The country of origin was not reported in 134 of the 1,887 reports. Gender was reported for 1848 patients; 944 males and 904 females. Patient age ranged from 1 to 84 years. Age was not provided on 94 patients. Events involving children less than 12 years of age totaled 286 reports (16% of reports with age noted).

### Deaths (Table 1)

Of the 314 patient deaths reported to MAUDE, 119 had an unknown cause. Deaths with an unknown cause are of increasing concern with the VNS device. The following is an example of the sudden deaths with no cause:

*An 18-year old patient died while running in a marathon. The patient reportedly started feeling badly, sat down by a tree, and subsequently experienced a long seizure after which the patient died. Efforts to revive the patient were unsuccessful. The physician indicated that the relationship between the VNS therapy system and cause of death is unknown.*

Seizure disorder was the leading cause of death with 54 reported events. This included 20 events of sudden unexplained death in epilepsy (SUDEP), 7 status epilepticus, 1 grand mal seizure and 26 events of seizures not otherwise specified leading to a patient death.

Respiratory events involved 49 patient deaths. Aspiration and/or pneumonia were reported in 23 deaths. The remaining patient deaths were related to suffocation/asphyxia (4), pulmonary edema (4), hypoxia (4), sepsis (2), asthma (2), acute respiratory distress syndrome (1), and pulmonary embolism (1), respiratory arrest (8).

Thirty-one patients died from cardiac related problems. Seven patients died as a result of myocardial infarction. Three patient deaths were related to fatal cardiac arrhythmia, including one case of pulseless electrical activity (PEA). The remaining 21 patients died from cardiac arrest and cardiac problems not otherwise specified.

Of concern are reports of 14 additional patients who expired during sleep, including one nine-year old child. No diagnosis of SUDEP was reported. The following is a narrative describing one of the 14 patient deaths:

*A 19 year old patient was found dead in their bed. Cause of death is not known at this time. The pt reportedly experienced a >50% reduction in seizures with the VNS therapy and was receiving therapy at the time of death.*

Three of the 314 patients reportedly committed suicide after the implant of the VNS.

When evaluating children less than 12 years of age during the 2.25 year time period, 38 children died after receiving the VNS device (12% of death reports with age noted), 9 of which list an unknown cause of death. The causes of death for the remaining 29 children included the following: respiratory (13), seizure disorder (5), cardiac (3), drowning (2), died during sleep (1), hypoxic ischemic encephalopathy (1), hemorrhagic bowel infarct (1), Angelman's Syndrome (1), sepsis (1), and dehydration/starvation (1).

See Table 1 for the remaining causes of death on the 314 patients.

### Injuries

Of the 1,887 patient events, 1,148 reported a serious injury. Of the 1,148 reported patient injury events, 302 (26%) devices were explanted.

Based on the firm's evaluations, only 1 out of 1,148 serious injuries was due to device being out of specification. Cyberonics assessment of the device-related aspect of the majority of injuries (88%) was inconclusive primarily due to lack of sufficient information from the reporter. In addition, the firm did not evaluate the majority of devices explanted.

The most frequently reported serious injury was **infection** (n=312; 27%). Infection reports with no further information included 104 reports. Infections that required explantation of the VNS device included 146 events, the majority of which were not reimplanted. An additional 17 events reported device dehiscence requiring explant. Reports of infection where the device was subsequently reimplanted included 16 events. Staphylococcus aureus infections made up 28 reports, nearly half occurred in children less than 12 years. One of the 312 patients developed an isolated case of endocarditis after device implant.

Increased **seizure activity** was the second most frequently reported patient injury with 259 of the 1,148 (23%) reports. Events categorized into "increased seizure activity" included any of the following criteria: increase in number of seizures, frequency of seizures, and/or type of seizure. Events that simply described increased seizures included 180 reports. Twenty-seven patients reported status epilepticus. Eleven patients experienced a grand mal seizure after VNS implant. Seizures involving a new onset or increased frequency of drop attacks/falls were reported in 13 patients. Three patients described the development of different types of seizures after VNS implant. Isolated events of increased seizures were associated with one of the following: hearing problems, speech disorder, facial droop, pain, hypotension, urinary retention, headache, and chest pain. Two events described the development of nighttime seizures not experienced prior to VNS implant. Two 5-year old patients described increased seizures and a new onset of sleep apnea. Two patient events described a loss of consciousness. One patient event described a 20-fold increase in seizure activity.

**Vagal nerve injury** is the third most common serious injury reported on the VNS with 136 of the 1,148 reports (12%). Eighty events of **vocal cord paralysis** have been reported. Hoarseness occurred in 56 patients, these reports did not conclude if vocal cord paralysis was diagnosed.

**Respiratory problems** (n=100, 9%) were the fourth most frequently reported serious injury with the VNS and included: sleep apnea (24), shortness of breathe (22) dyspnea (20), aspiration pneumonia (8), stridor (3), respiratory distress (10), choking/coughing (8) and asthma/airway problems (5). The majority of sleep apnea reports describe new onsets or worsening cases which led a few patients to undergo explant surgery.

**Cardiac related issues** made up 81 of the 1,148 (7%) serious injuries. This included the following: tachycardia, bradycardia, irregular heart rate, palpitations, hypertension, hypotension, syncope, loss of consciousness, and asystole.

Sixty-one events were related to **pain** experienced by the patient. Most events described pain in the neck and chest area.

**Wound dehiscence** and device erosion, migration and protrusion included 56 events.

Twenty-four events were related to **dysphagia**. These events involved difficulty swallowing, vomiting, reflux, GI distress, diarrhea and nausea. An additional, 18 patients reported significant weight loss ranging from 40-100 pounds.

Nineteen **depression** events were reported. The depressive events included, suicide ideations, mood swings, violent behavior, psychosis, memory loss and worsening depression.

Eleven reported events had a **vascular etiology**. Three patients developed a deep vein thrombosis, 3 had a stroke, and 4 developed a hematoma.

The following were reported ten or fewer times: Horner's Syndrome (10 cases with 4 in children under 12); allergic reactions (10 cases, with development of seroma or abscess); urinary retention (6 cases; 1 with loss of bladder control); lead breakage complications (5 cases); and gross motor problems (4 cases).

Three events were related to injuries sustained during a MRI scan. Three patients underwent a MRI scan according to labeling instructions and on two occasions the lead wires were "fried".

Three reports noted complications with pregnancy. One event reported fetal demise and one reported a confirmed miscarriage. The third event described a miscarriage that could not be confirmed.

Three reports noted hearing complications and one case of severe dysphonia was reported.

Two reports noted patients feeling shocked sensations from the VNS device.

Isolated cases were reported on each of the following: hemoptysis, headache, liver problems, lethargy, breast cancer, hemi diaphragmatic paralysis, decreased sexuality, acute arthritis exacerbation, epistaxis, confusion, laryngospasm, eye tic, magnetic field interference and encephalopathy following a glioma.

A new serious injury involved a 16-year-old patient. The report described decreased growth of breast tissue due to placement of the device.

Serious injuries in children less than 12 years of age totaled 181 reports (16%). Of the 181 serious injuries, 67 (37%) resulted in device explantation. The majority of serious injuries in children are related to infection, device dehiscence, increased seizure activity, vocal cord complications, and respiratory problems.

There appears to be an increase in the number of serious injuries reported in 2003 (Figure 1). The reason for this is unclear. In 2003, Cyberonics introduced a new VNS model 101. Some patients have reported more complications with this model.

Cyberonics VNS Adverse Event Reports by Year of Event 1994-2004\*

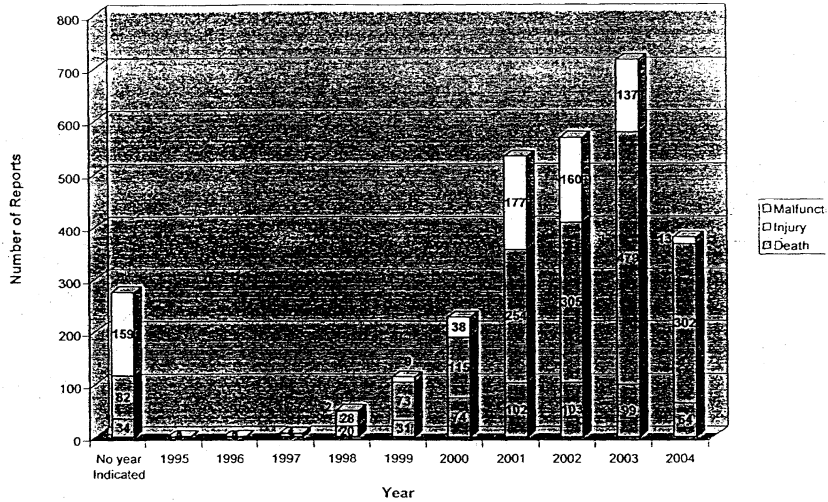

Source: MAUDE database 01/01/1995 -- 10/8/04

\*The numbers in the figure are not equal to the numbers quoted in the text since many reports do not note date of event.

Malfunctions

Device problem codes for the 425 malfunctions reported during the 2.25 year time period are listed in Table 2. The numbers do not total 425 malfunctions because more than one problem code may be reported for any one event. Table 2 lists the most frequently reported device problem codes for the VNS.

Lead breakage with the VNS is concerning because it has led to repeat surgery and increased seizure activity due to no stimulation.

Migration is a concern with the VNS. Multiple events have been received where the device migrated from the subclavicle area to the under arm area.

A recent inspection by the District Office-Dallas cited Cyberonics for not reporting early battery termination with the VNS generators. Therefore, it is not possible to assess or discuss the number of related adverse events.



**Table 1 – Reported Cause of Death in Patients Treated with VNS**

Cause of Death	All Deaths N=314	Deaths in patients under 12 years N=38
Unknown etiology	119	9
Seizure Disorders	54	5
SUDEP	20	4
Grand Mal	1	
Status Epilepticus	7	
Seizure Not Otherwise Specified (NOS)	26	1
<b>Respiratory</b>	<b>49</b>	<b>13</b>
Pneumonia	13	3
Aspiration	6	1
Aspiration pneumonia	4	1
Asthma	2	-
*Pulmonary Edema	4	1
Pulmonary Embolism	1	-
*Hypoxia	4	-
Suffocation/Asphyxia	4	1
Sepsis	2	-
*Acute Respiratory Distress Syndrome	1	-
NOS	8	6
<b>Cardiac</b>	<b>31</b>	<b>3</b>
Cardiopulmonary arrest	15	2
Myocardial Infarction (MI)	7	-
Cardiac arrhythmia (NOS)	2	-
*Pulseless Electrical Activity (PEA)	1	-
NOS	6	1
<b>Drowning</b>	<b>13</b>	<b>2</b>
<b>Died during sleep</b>	<b>14</b>	<b>1</b>
<b>Neurovascular</b>	<b>7</b>	<b>0</b>
Cerebral Vascular Accident (CVA)	2	-
Cerebral Aneurysm	1	-
Cerebral Hemorrhage	2	-
Cerebral Atrophy	1	-
Subdural Hematoma	1	-
<b>Encephalopathies</b>	<b>5</b>	<b>1</b>
Anoxic Encephalopathy	2	-
Hypoxic Ischemic Encephalopathy	1	1
Lisencephalopathy	1	-
Encephalitis NOS	1	-
<b>Gastrointestinal (GI)</b>	<b>3</b>	<b>1</b>
Hemorrhagic Bowel Infarct	1	1
GI Bleed	1	-
Stomach Pain	1	-
<b>Effects of congenital syndrome</b>	<b>3</b>	<b>1</b>
Aicardi Syndrome	1	-
Down's Syndrome	1	-
Angelman's Syndrome	1	1
<b>Fall/Trauma</b>	<b>3</b>	<b>-</b>
<b>Renal Failure</b>	<b>2</b>	<b>-</b>
<b>Suicide</b>	<b>3</b>	<b>-</b>
<b>Sepsis</b>	<b>3</b>	<b>1</b>
<b>Cancer</b>	<b>2</b>	<b>-</b>
<b>Dehydration/starvation</b>	<b>2</b>	<b>1</b>
<b>Bed entrapment</b>	<b>1</b>	<b>-</b>

Source: MAUDE database 7/1/02 – 10/8/04

\* New adverse event since the last safety report

**Table 2 – Malfunctions reported on the VNS**

Malfunction device problem <sup>1</sup>	N
High lead impedance	212
Device remains implanted	182
Explanted	126
Replace	91
*Lead breakage	78
Malfunction	27
Incorrect care/use of device	24
Device failure	20
Migration	18
Other	17
Device breakage	14
Reprogramming of implant	12
Programming calculations incorrect	10
Error message given	10

Source: MAUDE database 7/1/02 – 10/08/04

<sup>1</sup>Based on Device Problem Codes included in 10 or more events.

\* New adverse event since the last safety report

## Conclusions

- New adverse events included: hypoxia, pulmonary edema, Acute Respiratory Distress Syndrome, sleep apnea, wound dehiscence, and Horner's Syndrome. Reportedly, Horner's Syndrome has been attributed to the implant surgery for the VNS device. Sleep apnea appears to be exacerbated by the VNS.
- Approximately one-third of the death events are of unknown etiology. This may be of concern since these events include seemingly physically fit patients who expired with no known cause.
- Aside from the underlying seizure disorders, respiratory events made up the majority of death events with a reported known cause. Respiratory events were seen in the clinical trial safety data and during the first five years of device marketing, however, the proportion of reported deaths related to aspiration/pneumonia are of concern.
- Over one-third of the serious injuries reported for children under 12 involve device explantation. Serious adverse events frequently reported in children are infection, device dehiscence, increased seizure activity and vocal cord complications.
- Given the report of decreased breast tissue growth, the effects of the VNS in developing children needs to be evaluated.



DEPARTMENT OF HEALTH &amp; HUMAN SERVICES

Public Health Service  
Food and Drug Administration

## Memorandum

Date November 5, 2004

From Epidemiology Branch, DPS, OSB

Subject Consultative review of VNS Therapy System, PMA P970003/ST0/

To , DGRND, ODE.

Through: Director, Division of Postmarket Surveillance, OSB

**Purpose:**

The purpose of this memorandum is to provide a consult response to DGRND/ODE regarding the findings presented in the PMA P970003/ST0/ The specific question asked was whether the patients with severe depression could not be expected to improve by chance based on the latest data submitted by sponsor and the data from the relevant literature.

**Introduction:**

The Vagal Nerve Stimulator (VNS) Therapy System is indicated for use as an adjunctive treatment of chronic or recurrent depression in patients who are experiencing a major episode that has not had an adequate response to two or more antidepressant treatments. This review summarizes the long-term efficacy data submitted in the above referenced PMA.

**24 – month efficacy data:**

This submission contains two-year efficacy data for VNS Therapy in D-01 (pilot study) and D02 (pivotal study) patient populations. Out of 295 subjects implanted with the device in both studies (60 in D - 01 and 235 in D – 02), a total of 264 subjects were evaluable for efficacy. Of the total 264 evaluable subjects, 199 (75 %) provided Hamilton Rating Score for Depression (HSRD) efficacy data at two years.

The response at 24 months was achieved in 69 out of 199 (34.7 %) combined subjects (32.5 % in D – 02 and 43 % in D – 01 studies). The remission at 24 months was achieved in 36 of 199 (18.1 %) combined subjects (17.2 % in D – 02 and 21 % in D – 01 studies). The clinical benefits at 24 months based on the

percentage improvement from baseline was classified as “at least meaningful “ in 57 % of D – 02 and 68 % of D - 01 subjects.

The sponsor also submitted an analysis on sustained response to VNS therapy as an update to the analysis presented at the Panel meeting. The analysis showed that 70 % of D–02 subjects who responded to VNS treatment at 3 months were also responders at 24 months, and that 69 % of 12 – month responders remained responders at 24 months. The sponsor compared these findings with study of medication resistant ECT patients (Sakhaim et al., 2000) where less than 32 % response rates were observed at 6 month-1year.

Based on all above findings, the sponsor concluded that there were similar response and remission rates between the VNS therapy studies (D – 01 and D-02), that these effects were sustained and improved over time, and that they are clinically meaningful for the population studied. The sponsor also believes that because of the long duration of the study, it is not likely that the sustained efficacy is due to placebo effect, patient expectations, research center bias and other non-specific factors.

#### Comparison with other studies:

The sponsor provided a comparison of the VNS Therapy response at 24 months with long-term VNS Therapy for epilepsy (Morris et al., 1999) and found slightly higher response rates for epilepsy treatment (43 % in epilepsy vs. 34.7% in depression) and higher remission rates in depression treatment ( 17 % in depression vs. 5 % in epilepsy ) at 24 months. The continuation rates in both studies were around 80 % at 24 months.

The comparison with the treatment-resistant depression (TRD) study using venflaxine (Nierenberg et al. 1994) reported 32.9 % response rate (using HRSD) at 3 months, and 18.6 % at 6 months using Clinical Global Impression Scale (CGI). Since HRSD and CGI - 24 month data were not available, the sponsor made an assumption that the 6-month decrease implies further reduction in response rate.

Citing the Agency for Health Care Policy and Research Clinical Practice Guideline for depression, the sponsor stated that the difference in HRSD response between antidepressant drugs and placebo in an outpatient setting was 20 % for selective serotonin inhibitors, and 21 % for tricyclic antidepressants. The sponsor further compares this negligible difference in the reported active treatments with the observed difference of 17 % between subjects D-02 subjects receiving adjunctive VNS and D-04 receiving standard of care, and concludes that the efficacy benefit demonstrated by adjunctive VNS is clinically significant.

**Comments:**

- This study is a continuation of the original PMA study and as such contains the same design limitations identified in previous reviews by CDRH and CDER reviewers. The absence of placebo control continues to create difficulties in interpretation of study findings. I agree with the statement made by \_\_\_\_\_ (CDER clinical reviewer) that “any further manipulation of the data is not useful”.
- In the clinical community there is no consensus on what constitutes TRD and there have been more than 15 proposed definitions of this entity (Souery et al 1999). As a consequence of multiple definitions of TRD, different criteria for the number and types of previous failed therapies are used which leads to difficulties in ultimately concluding that the positive response is due to VNS therapy. This also makes comparison between different study populations very difficult. Other differences in study populations can also affect the meaningful comparison between different studies and contrary to the sponsors statement, we cannot rule out the placebo effect, research center bias etc.
- Although it is clear that sustained remission and not the response is a desired goal of the therapy, as indicated by many guidelines for treatment for Major Depressive Disorder (MDD) (e.g. American Psychiatric Association 2000, Canadian Psychiatric Association 2001, American Academy of Child and Adolescent Psychiatry, 1998), and that reported sustained rates are high in this study, the conclusion that the 24-month sustained remission rates are due to VNS therapy cannot be made based on these data.

**Conclusion:**

- In my opinion, the data presented in the above submission do not provide sufficient scientific evidence to establish long-term efficacy for this device.
- The presented findings are not sufficient to conclude that patient response and remission could not improve by chance.
- Statistically significant positive long-term findings from controlled clinical trials are necessary to establish efficacy.

---

Medical Officer, Epidemiology Branch



DEPARTMENT OF HEALTH &amp; HUMAN SERVICES

Public Health Service  
Food and Drug Administration

## Memorandum

Date November 5, 2004

From Mathematical Statistician  
Division of Biostatistics, OSB

Subject Statistical Review for PMA P970003/S50 (September 23, 2004), Vagus Nerve Stimulator (VNS) Therapy System for Depression, Cyberonics, Inc.

To  
Division of General, Restorative, and Neurological Devices, ODE  
Through: Director, Division of Biostatistics, OSB

I. Introduction

The VNS system is indicated for the adjunctive long-term treatment of chronic or recurrent depression in patients who are experiencing a major episode that has not had an adequate response to two or more antidepressant treatments. I have already reviewed several previous submissions, which include the "Revised Final Statistical Summary Review (April 29, 2004)", "The Neurological Devices Advisory Panel Meeting Presentations (June 15, 2004)", among others.

This amendment submission contains several issues (responses to the FDA's non-approvable letter, two-year, long-term clinical data from D-01 and D-02 studies, responses to ODE Dep. Dir. questions on the Panel slides, and responses to the June 15, 2004 Panel Recommendations." As we agreed, I have reviewed primarily the sponsor's newly submitted long-term 2-year D-01 and D-02 efficacy studies.

II. Sponsor's Findings and Reviewer's Comments

1. Patient Accountability and % Responders [ $\geq 50\%$  reduction in Hamilton Rating Score for Depression (HRSD) from baseline]

The above information is summarized in the following Table 1:

Table 1. Patient Accountability and Proportions of Responders

Category	D-01 (% Responders)	D-02 (% Responders)	D-01 and D-02 (% Responders)
No. Implanted	60	235	295
No. Evaluable	59	205	264
No. one-year	55 (25/55 = 45%)	181 (54/181 = 30%)	236 (79/236 = 33%)
No. two-year	42 (18/42 = 43%)	157 (51/157 = 32%)	199 (69/199 = 35%)

**Reviewer's Comments on Table 1 Results**

- A. The D-01 was designed as a feasibility study, which may not be combined with the pivotal D-02 study due to difference in clinical sites, response outcomes, and others.
- B. The D-02 clinical data are from 22 sites; in my 9/30/2002 memo, I stated that "A simple, direct summing of all aggregate counts of responses/non-responses over all centers is not statistically valid." Appropriate statistical methods/models are required to test for homogeneity of response proportions among centers, and if not rejected, a statistically pooled estimate of common response proportion would be required.
- C. The sample sizes decrease significantly from date of implant to the one-year and two-year follow-up. The estimated response proportions based only on the evaluable patient population are likely to be subject to bias.
- D. In my previous summary review dated April 29, 2004, for the 3-month randomized, double-blind, parallel trial, there is no statistically significant difference ( $p = 0.31$ , two-sided Fisher's exact test) between the active VNS (15% = 17/111) and the sham control groups (10% = 11/110) for HRSD-24. The current amendment fails to provide any additional information to compare HRSD response proportions between the active VNS and sham control groups.
- E. Since the D-02 patients received both VNS and standard of care treatment, the response proportions for D-02 patients shown in Table 1 cannot separate the true VNS effect from the combination (VNS plus standard of care) effect. A well-designed independent control group would be required to estimate the true VNS effect.
2. Primary Effectiveness Analysis (comparison of average rate of changes (slope) or mean differences in IDS-SR between D-02 and observational control D-04 patients)

In my 6/15/2004 Panel presentation, I summarized the estimated mean difference (D02-D04) in IDS-SR improvement [by repeated-measure linear regression (RMLR) with covariates and propensity score adjustment] at one-year follow-up, as shown in Table 2:

Table 2. Difference (D02 – D04) in IDS-SR (Maximum score = 84) at 1-year

Covariate adjustment*	Sites included	Estimated mean difference (D02 – D04)	95% confidence interval
None (observed raw data)	All 22 sites	- 6.6	(-10, -3.2)
Covariate adjusted (RMLR)	All 22 sites 12 <i>Overlapping</i> sites** (D-02 censored)	- 4.8 - 2.1	(-6.3, -3.3) (-3.84, -0.54)

(\* Propensity score analysis and other covariates; \*\* sites participated in both of D-02 and D-04 studies)

I stated previously that clinical judgment is needed to decide whether the above mean IDS-SR differences and their 95% confidence intervals are clinically meaningful to evaluate true VNS effect.

In Figure 1.3-2 (page 22 of 32, Clinical Report), the sponsor stated that “Even if a prognostically favorable patient covariates was overrepresented in the D-02 group, it would not by itself explain why the D-02 subjects improved more than did the D-04 group”, after adding several patient covariates (age, gender, and others) in the RMLR model. I do not agree with the sponsor’s statement, since these observed patient covariates had already been included in the sponsor’s original propensity score analysis. Without an appropriately designed, independent, randomized, double-blind, multi-center, controlled-trial, equal distribution of both observed and unobserved patient covariates between the VNS and control groups cannot be assured. It is not easy to separate the confounding effect of increased medications and/or electroconvulsive therapy (ECT) from true VNS effect.

In Figure 1.3-3 (page 23 of 32, Clinical Report), the sponsor provided the difference (D02 – D04) in estimated slope (average rate of change per month of IDS-SR, by RMLR) for 12-month follow-up data by original analysis (-0.397 per month, or approximately -4.8 points per year of total of 84 points), and various missing data imputation methods (both D-02 and D-04 last value carried forward (LVCF) after censoring, and others). Since there is no gold standard with which to impute the missing data, it is not easy to determine which of the sponsor’s newly proposed missing data imputation methods is more clinically/statistically appealing. I do not see similar results for two-year D02/D04 comparison.



**III. Conclusion**

Due to the absence of an appropriately-designed randomized (by clinical site), parallel, independent, carefully masked clinical trial, clear inference of medication use and/or ECT during patient follow-up, and clear effect of unmeasured patient covariates on clinical outcomes, along with questionable prediction of IDS-SR on HRSD, questionable pooling of unbalanced, multi-center data, and lack of pre-specified clinical utility in difference of slopes or mean scores of D-02/D-04 comparisons, it is unclear whether the effectiveness of D-02 over D-04 patients has been statistically validated. There is no new, additional information presented in this amendment to change the above findings.

cc:

Medical Device File  
Board File

DEPARTMENT OF HEALTH AND HUMAN SERVICES

PMA-S Memo

Division of General and Restorative, and Neurological  
Devices  
General Surgery Devices Branch,

Food and Drug Administration  
Office of Device Evaluation  
Center for Devices and Radiological Health  
9200 Corporate Boulevard  
Rockville, MD 20850

**Date:** 6/22/04

**To:** The file

**From:** Medical Officer

**Subject:** Post-panel Memo

**P970003-S050**

**Panel meeting:** The Neurological devices panel met to discuss the PMA-S 970003-S50 on June 15<sup>th</sup>, 2004. The panel deliberated on 5 FDA questions including the necessity of a randomized study design in mood disorder treatments, the impact of concomitant treatments on the D02/D04 comparison, the potential for placebo effect in a non-randomized unblinded study and the final 2 questions of safety and efficacy. The panel members (this section to be expanded once the transcript is available) agreed that a non-randomized study design made conclusions about effectiveness challenging as did the impact of possible placebo effects. The panel agreed that the device seemed safe, but was split on whether efficacy was shown in answering the final question. The meeting concluded with a vote of conditional approval 5 to 2. The conditions included changing the labeling to include patients who have failed 4 adequate treatments instead of 2.

**Outstanding safety issues:** Despite the panel's agreement that the device is safe, I believe that safety can only be assessed as a risk/benefit ratio, and thus efficacy must also be demonstrated. Surgically implanted devices carry known risks including infection, need for future removal of the device, and injury to structures in and around the operative site (specifically vagal and recurrent laryngeal nerve injury) as well as the risk of anesthesia, which is also significant. In order to outweigh these risks, a device must demonstrate efficacy.

Further, by the sponsor's own admission, the long term safety of this device was not adequately addressed by the randomized acute phase of D02. A long term assessment was needed. However, the long term study presented (the D02 long term phase) had no control group with which to compare safety data. This data was not collected in D04, the selected comparison. Therefore long term safety has not been adequately addressed in the PMA.

Additionally, the issue of safety was based partially on the safety profile of the same devices use in epilepsy. Review of the MDR database by OC has revealed an increase in the reports of sudden death since a letter was sent to the sponsor warning them about under reporting of adverse events in 2001. An investigation into this increase in death MDR's as well as the clinical data the sponsor has used to support the findings that these deaths are not device related is underway. Until this investigation is complete, this remains an unanswered safety concern with the use of this device.

**Outstanding efficacy issues:** During panel deliberations (this section to be edited when transcript is available) several panel members indicated that they felt efficacy was not

adequately demonstrated by the non-randomized study design. They felt, however, that the device could be labeled for use in patients only after all other therapies that have been proven effective based on rigorous study designs were exhausted. The CRF 860.7(e)(1) states that for a device to be approved there must be reasonable assurance of efficacy. In their vote, the panel chose to vote for conditional approval based on an unmet need despite a lack of efficacy. The burden of proof of efficacy is not variable based on the need of a patient population in which it is to be applied. The sponsor admitted that a prospective, randomized, long-term trial was now feasible. They however attempted to persuade the panel by claiming that 36000 patients would die during the three years that it would take to complete such a trial. The data provided in the PMA do not support a decreased rate of suicide in the treated patients compared to the control population (D04). Therefore it is not unethical to conduct an appropriate trial, but is unethical to approve the implantation of a device whose efficacy is unproven.

The sponsor repeatedly claimed that the placebo effect was not a factor in the differences seen between D02 and D04 outcomes because placebo effects were minimal in TRD and diminished rapidly. Their own data set suggests otherwise, since the sham group of the acute study had a 10% response rate at 3 months, indicating that the actual placebo responder rate in TRD as 10% and persisted for 3 months time. The difference between responders for IDS-SR in the D02/D04 comparison was 10% (22% vs 12%) and 17% for the HAM-D (30% vs 13%). Thus these differences are similar to the placebo response seen in the acute phase. When the data is censored to account for concomitant antidepressant treatment changes in D02 the responder rate (HAM-D) drops to 16% for the D02 group vs 13% for the D04. At this point the expected placebo rate of 10% is greater than the difference between the two groups. Thus one can reasonably conclude that the differences between the treatment and control groups in this long-term study could be completely due to placebo effects and concomitant antidepressant treatment changes. Given this uncertainty about whether any of the effect was due to the treatment itself, a new, prospective, randomized trial is necessary prior to approval of this invasive treatment.

**Recommendation:** I recommend this application is not approvable. The sponsor has failed to show a reasonable assurance of efficacy. While the panel was swayed by emotional pleas and was made to feel responsible for future suicides of patients with TRD should this device not be approved, the sponsor failed to provide adequate data to support the efficacy of this device in the treatment of chronic, resistant depression. Despite the sponsor's attempts, the issues of placebo effect, concomitant antidepressant treatment changes, and difference between the treatment and observational control groups remain potential factors in the observed benefit of the device.

This device represents a treatment for depression that should be viewed as no different than any drug labeled for depression, thus the requirement of a prospective, randomized, placebo controlled, double blinded trial should be applied equally to this device as it is to drug therapies.

Medical Officer



DEPARTMENT OF HEALTH & HUMAN SERVICES

Food and Drug Administration  
Center for Devices & Radiological Health

Division of General, Restorative, and Neurological Devices  
Restorative Devices Branch  
9200 Corporate Boulevard HFZ-410  
Rockville, MD 20850  
(301) 594-1296

Date: 01/06/05  
To: FILE  
From: , PMA Team Leader  
Subject: Review Memo for P970003/S050/

**PMA 970003**

**Introduction**

The following is a final review memo of activities related to P970003 Supplement 50, including comments on data submitted in Amendment (Sponsor response to August 11 2004 not approvable letter), requesting FDA approval of the Vagus Nerve Stimulation (VNS) therapy system for the adjunctive long-term treatment of chronic or recurrent depression for patients over the age of 18 who are experiencing a major depressive episode that has not had an adequate response to four or more antidepressant treatments.

**Sponsor**

Cyberonics, Inc.

**Device Description**

The VNS Therapy System consists of an implantable VNS Therapy Pulse Generator, the VNS Therapy Lead and the external programming system used to change stimulation settings. The pulse generator is an implantable, multi-programmable pulse generator that delivers electrical signals via the lead to the left vagus nerve. The external programming system includes a programming wand, the Model 250 programming software, along with a compatible computer. The software allows a physician, with the programming wand placed over the implanted pulse generator, to identify, read and change device settings.

**Recommendation**

Not Approvable

**ODE REVIEW ACTIVITIES**

**August 11 2004 FDA transmits to the Sponsor a Not Approvable Letter**

On August 11 2004, a not approvable letter was sent to the Sponsor that included the following issues (verbatim):

Safety

There are safety concerns associated with the use of your device, including known risks related to implantation or stimulation, including serious adverse events such as asystole/bradycardia and vocal cord paralysis. In addition to known safety concerns, worsening depression was reported as a serious adverse event during the long-term D02 study. Without comparison to a control population, we are unable to determine whether your device places patients at increased risk for this event. As a result, we believe you have not provided a reasonable assurance that the probable benefits to health from use of the device for its intended uses and conditions outweigh the risks associated with its use.

Effectiveness

A chief limitation of the long-term pivotal D02 clinical study, observational control D04 study comparative analysis was that the data were not derived from a randomized subject data set, but rather a comparison of outcomes from an investigational device study and observational control study. As a result, our ability to make meaningful conclusions from the data you provided was affected by the following limitations:

- a. Failure of the randomized, controlled pivotal D02 acute study to reach its primary efficacy endpoint.
- b. Potential bias of a non-randomized data set in the long-term D02, D04 comparative analysis that could reasonably affect the clinical outcomes reported in your study.
- c. Potential bias of unmeasured patient variables in the long-term D02, D04 comparative analysis that could reasonably affect the clinical outcomes reported in your study.
- d. Potential bias of unmasked ratings in the long-term D02, D04 comparative analysis that could reasonably affect the clinical outcomes reported in your study.
- e. Potential bias of research centers having more interest in the treatment study (the pivotal D02 study) rather than the naturalistic, observational control study (the D04 control study) that could reasonably affect the clinical outcomes reported in your study.
- f. Potential bias of patient expectation of participating in an investigational study for a new therapy versus the expectation of participating in an observational, control study that could reasonably affect the clinical outcomes reported in your study.

- g. Inability to distinguish the improvement attributable to VNS therapy from the improvement attributable to a placebo response in the long-term D02, D04 comparative analysis.
- h. Inability to distinguish the improvement attributable to VNS therapy from the improvement attributable to concomitant antidepressant treatments in the long-term D02, D04 comparative analysis.

The letter also requested the Sponsor provide clinical data from a new, scientifically sound, randomized, controlled study, which addresses concomitant treatment use and includes adequate safety assessments in both the treatment and control group.

**September 10 2004 Sponsor submits Treatment IDE**

On September 10 2004, the Sponsor submitted a Treatment IDE supplement (G980099\_S60). FDA granted approval of the Treatment IDE supplement on October 15 2004. Please see administrative file G980099 for further information.

**September 23 2004 Sponsor submits Amendment to Address Not Approvable**

The Sponsor submitted Amendment to FDA to address the deficiencies listed in the not approvable letter dated August 11 2004 containing the following:

- a. A discussion of the safety and effectiveness concerns contained in FDA's August 11 2004 not approvable letter
- b. Two-year, long-term clinical data from the D-01 and D-02 studies;
- c. A copy of the September 7 2004 responses submitted to ODE Dep. Clin. Dir. during the informal PMA-S appeal process;
- d. Responses to the June 15 2004 Neurological Devices Panel recommendations regarding conditions of approval including labeling for Physicians and Patients; and
- e. Additional literature.

FDA Review of Amendment

- a. A discussion of the safety and effectiveness concerns contained in FDA's August 11 2004 not approvable letter

*Sponsor Responses to Not Approvable Letter Deficiencies Re Safety*

To address safety concerns, the Sponsor reports safety risks are modest, well characterized, and adequately described in the FDA approved labeling for the VNS Therapy System. Since there exist known risks of using a long-term implantable device and considering the Sponsor conducted a well controlled study that failed to significantly demonstrate effectiveness along not only the primary

efficacy endpoint (Hamilton Rating Scale for Depression [HRSD]), but along several secondary, standardized patient assessment tools (Montgomery Asberg Depression Rating Scale [MADRS], Clinical Global Impression [CGI], Quality of Life SF36 [SF36]), except for the Inventory of Depressive Symptomatology-Self Rating [IDS-SR], any safety risk associated with using a long-term implant, in the absence of a reasonable assurance of effectiveness data, is excessive. The absence of a control group for a long-term implant is troublesome (by itself) and without a control population, one cannot accurately assess any increased risks of using the device for this indication. To address observed risks during the study, the Sponsor has provided safety data from a different pathology (epilepsy) and extrapolation data to assess other serious adverse events (i.e., worsening depression by using the hospitalization records from the observational, control D04 population). Use of safety data from epilepsy, although supportive, cannot predict the safety profile for severely depressed patients, also referred to as treatment-resistant depression (TRD). Epilepsy and TRD are separate and pathologically distinct neurological entities. Hospitalization records, although supportive, cannot address the occurrence of worsening depression in their control patient population. Finally, the observation of worsening depression, in the treatment group, may suggest a lack of efficacy of the device.

*Sponsor Responses to Not Approvable Letter Deficiencies Re Effectiveness*

To address effectiveness concerns, the Sponsor reports comparative analyses not derived from a randomized subject data set, but rather comparison of outcomes from an investigational device study and observational control study. The Sponsor states the improved outcome in patients implanted with the VNS System is due solely to use of the device and limitations associated with the trial design of the studies are unlikely to account for the differential outcomes observed between D02 (VNS) and D04 (observational control group). From a scientific standpoint, it is well established that in the absence of a randomized, controlled study, basic clinical trial design concerns exist including basic limitations such as sites, patients, and physicians not randomly assigned to two different study groups. Two benefits are expected from randomization: unbiased allocation of treatment, because of easier concealment of the allocation scheme, and application of statistical theory on the basis of random sampling. More importantly, randomization becomes even more important when discussing psychiatric mood disorders (for reasons further discussed below). Although the definition of valid scientific evidence includes evidence from well-controlled investigations, partially controlled studies, studies and objective trials without matched controls, well-documented case histories conducted by qualified experts, and reports of significant human experience with a marketed device, from which it can fairly and responsibly be concluded by qualified experts that there is reasonable assurance of the safety and effectiveness of a device under its conditions of use (CFR 860.7), it is well established that mood disorder studies pose additional challenges due to natural history of the disease and the large, variable placebo response rates that could reasonably account for response rates when assessing a

novel intervention (also discussed below), thus should be studied under randomized controlled environments.

*The Sponsor also discussed specific effectiveness deficiencies noted in the not approvable letter.*

- Failure of the randomized controlled pivotal D02 acute study to reach its primary efficacy endpoint

The Sponsor reports although the randomized, controlled pivotal D02 acute study failed to reach its primary efficacy endpoint, a secondary endpoint did demonstrate statistical significance. The Sponsor also reports numerical significance of other analyses. The primary efficacy endpoint for the D02 study was the percent responders based on the HRSD score from baseline to acute phase exit in the evaluable population. Unfortunately, of the 111 observed treatment group subjects, 17 (15%) were responders at acute phase exit (Visit 9), compared with 11 of 110 observed sham treatment control subjects (10%). The number of responders in the treatment group was not significantly greater ( $p=0.238$ ) than the number of responders in the sham treatment control subjects. The study failed to significantly demonstrate effectiveness along several secondary patient assessment tools (MADRS, CGI, SF36), except for one assessment tool (IDS-SR). The acute study was the only well controlled study submitted to FDA for review and VNS treatment failed to demonstrate a significant improvement beyond standard of care along the primary measure of effectiveness. The outcome of the acute study remains an issue in determining whether the Sponsor has submitted sufficient data to establish a reasonable assurance of effectiveness.

- Potential bias of a non-randomized data set in the long-term D02, D04 comparative analysis that could reasonably affect the clinical outcomes reported in your study

The Sponsor reports a propensity adjustment strategy to address the potential bias of a non-randomized data set in the long-term D02, D04 comparative analysis. However, not all baseline prognostic covariates were equivalent including the percentages of subjects who had ECT (VNS patients had more ECT treatment) and number of lifetime episodes (D04 patients had more). The Sponsor claims these differences probably off set one another. No references have been provided regarding whether ECT treatment and number of lifetime episodes “off set” one another. As noted at the June 15 2004 panel meeting, despite the extraordinary analyses presented by the sponsor, attempting to demonstrate that the baseline observed differences and other characteristics that might affect the nature of the patients that were entered into the two arms were no different, there were differences observed. Thus, one cannot replace the concept of randomization, especially for all of the variables that were either not measured or not considered when comparing the investigational study and observational control study.

- Potential bias of unmeasured patient variables in the long-term D02, D04 comparative analysis that could reasonably affect the clinical outcomes reported in your study



The Sponsor reports it is unlikely that unmeasured covariates affected clinical outcome. While it is true that a randomized, controlled study may not evenly distribute patient variables equally between treatment arms, the use of a prospective, randomized, controlled trial with standardized outcome tools and independent assessments is an important study design from a scientific standpoint, and should not be easily dismissed based on the unmet need of a patient population or lack of effective therapies. As reported in the FDA Clinical Review Memo presented at the June 15 2004 panel meeting, in the D02, D04 comparative analysis, a statistical propensity adjustment strategy is not able to address problems of potential bias due to other unmeasured patient variables including past thyroid dysfunction, neurotic pre-morbid personality, and familial predisposition for affective disorder, multiple loss events, or socio-cultural level (Souery et al., 1999). Furthermore, additional unmeasured patient variables (not mentioned previously) including individuals with fewer interpersonal or economic resources with possibly higher levels of objective stress, poorer social supports, and/or a greater risk of noncompliance (Thase and Rush, 1995) can also bias treatment outcomes, and best be addressed with a randomized, controlled design.

- Potential bias of unmasked ratings in the long-term D02, D04 comparative analysis that could reasonably affect the clinical outcomes reported in your study
- Potential bias of research centers having more interest in the treatment study (the pivotal D02 study) rather than the naturalistic, observational control study (the D04 control study) that could reasonably affect the clinical outcomes reported in your study
- Potential bias of patient expectation of participating in an investigational study for a new therapy versus the expectation of participating in an observational, control study that could reasonably affect the clinical outcomes reported in your study

The Sponsor addressed effectiveness concerns outlined above as insignificant. However, a significant difference in patient enrollment occurred as demonstrated by patient enrollment into either the VNS study or the observational, control D04 study. First, the majority of D04 subjects enrolled after D02 was closed. Second, overlapping sites usually screened and offered patients enrollment into D02 prior to enrollment into D04 (D02 offered a new treatment as opposed to standard of care). Although both Study D-02 and D-04 were available to enroll subjects at similar time periods, almost all D-04 subjects enrolled into the study after D-02 was closed for enrollment. Only 10 D-04 subjects enrolled while D-02 was open; sites were more focused on the treatment study (D-02) rather than the naturalistic, observational study (D-04). During the period of time when nine overlapping sites (*sites able to simultaneously enroll D-02 and D-04 subjects*) are analyzed, the Sponsor estimates there were 49 enrolled D-02 subjects who could have enrolled into the D-04 study (patient were interested in enrollment into an investigational study). Patients who did not meet D02 entry criteria or who decided they were not interested in D02 were then offered entry into D04. After D02 closed, clinical sites had a pool of subjects interested in D02 that were also

eligible for D04. Subjects that could not enroll in D02, these are the subjects that were typically enrolled into D04. Thus, patient expectation for participating in an investigational study for a new therapy may have been greater than the expectation of participating in an observational, control study. Third, outcome assessors were not blinded to treatment assignment and could have biased the results in favor of the VNS therapy group. Fourth, while the Sponsor has provided videotape assessments of D02 study subjects (VNS patients), no videotape assessments were provided for the observational, control group (observational control patients). And fifth, while self reports could corroborate clinician rated scales, the correlation value associated with self report assessments and clinician rated scales were marginal (see statistical analyses).

- Inability to distinguish the improvement attributable to VNS therapy from the improvement attributable to a placebo response in the long-term D02, D04 comparative analysis

The Sponsor claims the naturalistic history of the course of illness of patients with TRD argues against a placebo response as a reason for differential outcomes in the long-term D02, D04 comparative analysis. First, there is very little published literature on the placebo response in TRD. The only publication presented upon TRD placebo response (Thase and Rush, 1995), suggests placebo response rates (without specifying length of response) in the absence of well established published literature. Second, the long-term D02, D04 comparative analysis was not a well-controlled study. The only well controlled study conducted was the acute D02 phase and which reported that the number of TRD responders in the treatment group was not significantly greater ( $p=0.238$ ) than the number of responders in the sham treatment TRD control subjects. By comparative estimates, the modest clinical outcome (across several validated psychiatric measurement scales including the HRSD and MADRS) was largely a placebo response.

- Inability to distinguish the improvement attributable to VNS therapy from the improvement attributable to concomitant antidepressant treatments in the long-term D02, D04 comparative analysis

The Sponsor unblinded the acute phase of D02 (IDE G980099) in 2002. The efficacy results did not demonstrate a statistically significant difference between responders (defined as  $\geq 50\%$  improvement in HRSD total score from baseline to acute phase exit) in the treatment (17/111) arm and sham treatment control (11/110) arm. Despite the failed randomized, controlled outcome, the Sponsor claimed a pattern of increasing treatment effect over time, and suggested that the full antidepressant effect of VNS Therapy might take longer (for an effect). Continuing to follow patients implanted with VNS Therapy long-term, both the protocol for the D02 long-term phase and the protocol for the D04 study permitted the use of antidepressant therapies (drugs and ECT) other than VNS therapy; neither study specified any criteria for the added or increased use of concomitant (i.e., non-VNS) antidepressant treatments over long-term follow-up (12 months), other than permitting its use. To further examine the impact of

concomitant antidepressant treatments upon long-term outcomes, the Sponsor provided an asymmetric analysis using the primary repeated measures linear regression analysis of the Inventory of Depressive Symptomatology-Self Report (IDS-SR) scores after censoring the D-02 subjects' scores for concomitant antidepressant treatment changes (i.e., the subject's last IDS-SR score before the concomitant antidepressant treatment change was used for subsequent assessment points, a last-observation-carried-forward approach). The primary efficacy analysis between D02 and D04 outcomes reported a statistically significant difference ( $p < 0.001$ ) in the estimated IDS-SR raw scores per month between D02 and D04 at 12 months (-0.397 estimated average difference per month). If a subject added or increased a concomitant antidepressant treatment (medication or ECT), and their subsequent IDS-SR scores were not used (a censored analysis employing a last-observation-carried-forward approach), the difference observed in the estimated IDS-SR raw scores per month between the D02 and D04 was not statistically significantly different ( $p > 0.05$ ) from standard of care. When a censored analysis employing a last-observation-carried-forward approach was employed to remove any bias of concomitant treatments, these results suggested patients treated with VNS experienced no increased treatment effect or advantage beyond the treatment effect received under standard of care.

- b. Two-year, long-term clinical data from the D-01 and D-02 studies;

*Follow-Up Two Year Clinical Data on VNS Patients*

The Sponsor has also provided categorical clinical data of patients implanted with VNS Therapy Systems up to two-years (not previously presented in the original PMA application). The Sponsor suggests response and remission rates that are 1) similar between VNS Therapy studies, 2) improved or maintained over time, and 3) are clinically meaningful for treatment-resistant depression. From a scientific standpoint, there are several concerns with this data set including the following:

- August 11 2004 Deficiencies Have Not Been Addressed

The submission of additional follow-up cannot address the deficiencies presented in the not approvable letter dated August 11 2004. The concerns of a comparative analysis in the absence of a randomized subject data set, but rather a comparison of outcomes from an investigational study and observational control study is problematic. As stated previously, from the Division of Neuropharmacological Drug Products, further manipulation of the original clinical data (i.e., additional follow-up, sustained response, literature comparisons, medication changes, model sensitivity, and censoring modeling: new analyses) is without merit, considering the basic design flaws from which the data was originally collected.

- Lack of a Placebo Control Group

The long-term follow up of patients in the absence of a control group is troublesome. The clinical characteristics of participating in an investigational study with a novel device, which includes considerable evaluation and attention and creates high expectations for improvement, render trial participants

particularly likely to improve with placebo (Sacks et al., 2003). Results presented in the original PMA submission confirm a placebo response, in at least the well controlled acute D02 phase. The addition of a control group (placebo controlled trial) long-term would enable one to determine whether improvement is attributable to use of VNS or for other reasons (i.e., medical management). This consideration is important considering the failure of the acute phase.

- Different VNS Outcomes Across VNS Studies

The difference between the outcomes in D01 (an open label, non-randomized, uncontrolled feasibility short-term and long-term study, including unrestricted use of concomitant treatments) and D02 (a randomized, controlled short-term study, including restricted use of concomitant treatments, and an open label, non-randomized, uncontrolled long-term study, including unrestricted use of concomitant treatments) suggest that trial design may have an impact upon psychiatric outcomes.

- Different Scheduled Follow-Up Across Studies

During the long-term phase, all patients implanted with a VNS Therapy System (D02) had scheduled follow-up evaluations at months 3, 6, 9, and 12 (Table 8.1.0-2, original PMA application). VNS Therapy patients had Hamilton Rating Scale Depression assessments (HRSD), Montgomery Asberg Depression Rating Scale (MADRS), and Inventory of Depressive Symptomatology-Self Report (IDS-SR) assessments, including scheduled monthly assessments up to 12 months; Clinical Global Impression (CGI) assessments, including scheduled monthly assessments beginning at 6 months up to 12 months; and other quality of life assessments including, a 6 month, 9 month, and 12 month assessment. In contrast, observational control patients (D04) had 4 scheduled follow-up visits (with assessment batteries) during the first 12 months (Table 8.1.0-2, original PMA application), and it is unclear the extent of follow-up provided after 1 year. Because the observational control D04 patients experienced significantly different scheduled follow-up (in comparison to VNS patients), it is unclear whether “control” patients were treated differently than implanted patients. The lack of standardized scheduled follow-up care in the observational, control group (D04) is troublesome and may suggest additional limitations in the comparative analysis between the D02 study and the observational control D04.

- Literature demonstrates severely depressed patients can improve

In Trivedi et al. (2004) the investigators compared clinical outcomes in patients with major depressive disorder during 12 month algorithm-guided treatment (ALGO) compared with treatment as usual (TAU). All patients improved during the study, but ALGO patients had significantly greater symptom reduction on the IDS-Clinician Assessment and IDS-SR during the first 3 months, compared with TAU. Both groups also continued to improve during the subsequent 9 months. These results are significant for a number of reasons and raise the question in the VNS studies of whether one can attribute the durability of the 3-, 12-, and 24-month outcomes in VNS patients to the effectiveness of the VNS Therapy System. First, the impact of

ALGO compared with TAU was largely accounted for by patients with severe and very severe baseline scores. These results suggest that severely depressed patients in particular can improve when treated with medical management. Second, although all study participants provided demographic and medical history at baseline and during outcome assessments every 3 months for at least 12 months, ALGO identified critical decision points (e.g., weeks 4, 6, 8, 10, and 12) for each medication when revisions in treatment strategies or tactics were to be undertaken based on degree of symptom change and side effect burden, a procedure that indicates how patients are managed (i.e., follow-up schedule) may influence outcome. Third, Trivedi et al. (2004) reported patient response rate outcomes (ALGO patients) at 3 months (22/115[19%]) and 12 months (23/78[30%]). Response rates between treatment groups reported in Trivedi et al. (2004) appear similar to VNS response rates between treatment groups at 3 months (48/264[18%]) and 12 months (79/236[34%]).

- c. A copy of the September 7 2004 responses submitted to ODE Dep. Clin. Dir. during the informal PMA-S appeal process; and

*Responses to questions during the informal PMA-S appeal process*

On September 7 2004 the Sponsor provided responses to questions from ODE Dep. Clin. Dir. on the Panel Slides and the August 17 2004 ODE Presentation Slides. A copy of the responses was included in Amendment 11.

- d. Responses to the June 15 2004 Neurological Devices Panel recommendations regarding conditions of approval including labeling for Physicians and Patients

*Sponsor Responds to Conditions of Approval*

The Sponsor provided responses to the panel recommendations (conditions of approval) identified at the June 15 2004 Neurological Devices Panel meeting including revised indications for use, Physician manual labeling, and Patient Manual labeling. However, the Sponsor responses are unable to address the following:

- Indications for use is an issue

It is unclear whether the indications for use (adjunctive long-term treatment of chronic or recurrent depression for patients over the age of 18 who are experiencing a major depressive episode that has not had an adequate response to four or more antidepressant treatments) are appropriate. The recommendations of the June 15 2004 Neurological Devices Panel reserving VNS for patients who have failed several antidepressant treatments (4+) do not agree with patient responder baseline characteristics in published literature (Sackeim et al., 2001), which reports VNS is more therapeutic in low to moderately depressed patients (not severely depressed);

- Labeling is an issue

It is unclear whether the instructions for use are sufficient. The Sponsor has not defined when VNS therapy system has a treatment effect, nor has the Sponsor determined the necessary dosage for safely and effectively treating patients;

**November 10 2004 Review Team Meeting to discuss Amendment**

Please see November 10 2004 Review Team Meeting Minutes for further information. Subsequently, the Review team briefed the ODE Director on November 16 2004 regarding their review of the application, including the latest amendment and the Center Director on November 19 2004 regarding their review of the application, including amendment . The review team recommended upholding the not approvable decision based upon scientific, clinical, and regulatory deficiencies.

**December 1 2004 FDA Clinical Staff meet with the Sponsor**

On December 1 2004, CDRH Center Director and FDA clinical staff, including met with the Sponsor's clinical staff, including the Sponsor's statistical staff, including the Sponsor's legal staff, including , and the Sponsor's management staff, including Mr. , to discuss the deficiencies listed in the not approvable letter dated August 11 2004. The Sponsor presented clinical data from their existing studies to address the deficiencies listed in the not approvable letter dated August 11 2004. FDA staff presented the rationale for why clinical data from existing studies cannot address the deficiencies listed in the not approvable letter.

**December 8 2004 CDRH Director Post-Sponsor Meeting**

On December 8 2004 the review team briefed the Center Director of their assessment of the December 1 2004 meeting with Sponsor. The review team recommended upholding the not approvable decision based upon scientific, clinical, and regulatory deficiencies.

**COMPLIANCE ACTIVITIES**

Please see Tab 7-QSR (GMP) for a complete summary of compliance activities.

On December 22 2004 the Dallas District Office of Compliance issues a compliance warning letter in response to an inspection that revealed that devices were adulterated within the meaning of Section 501(h) of the Act, in that the methods used in, or the facilities or controls used for their manufacturing, packing, storage, or installation are not in conformance with the Current Good Manufacturing Practice (CGMP) requirements of the Quality System (QS) Regulation for medical devices, as specified in Title 21, Code of Federal Regulation (CFR), Part 820.

**BIORESEARCH MONITORING ACTIVITIES**

Please see Tab 8-BIMO for a complete summary of bioresearch monitoring activities.

The Division of Bioresearch Monitoring (DBM) reviewed and evaluated the establishment inspection reports (EIRs) for the sponsor and two (2) clinical investigators

; and .) Of the 28 subjects at site (14 each in studies D-02 and D-04), 6 files were reviewed in depth, and 7 discrepancies between source data and the data on the case report forms (CRFs) were noted. Personnel attributed these to transcription errors. This high percentage of discrepancies, combined with the fact that a number of source documents were also missing, suggests inadequate monitoring and/or data auditing. Discussions with the lead reviewer in this regard revealed that data discrepancies were also noted between tables in the PMA supplement. DBM suggests that it is the sponsor's responsibility to assure us that the data submitted in support of this supplement is reliable, most probably by use of a third party auditor to certify accuracy. A final decision in this regard awaits discussion with the ODE Integrity Officer and the ODE Division management.

On December 10, 2004, the Division of Bioresearch Monitoring issued a Warning Letter to , clinical investigator, NIH, Bethesda, Maryland for failure to submit progress reports to the institutional review board, ensure that the investigation was conducted in accordance with the conditions of FDA regulations and IRB approval, conduct the study according to the protocol, and failure to document informed consent.

#### **RECOMMENDATION**

Treatment-Resistant Depression (TRD) is a term used to define patients who repeatedly respond poorly to medical therapy. TRD is a serious, costly, devastating psychiatric disorder that has a large emotional and financial burden upon the patient and family members. Currently, no FDA approved or standard treatment approach exists to manage patients who have failed multiple drug treatments of adequate dose and duration. Unfortunately, the majority of open-label feasibility studies (D01, D03, D04) presented to FDA have not been randomized, controlled studies, and the one randomized, controlled study (acute D02 clinical study) comparing VNS Therapy to standard of care failed to reach its primary efficacy endpoint (HRSD), as well as failed to reach statistical significance on several secondary endpoints (MADRS, CGI, SF36). In addition, control safety data was not systematically collected long-term. The one patient assessment tool (IDS-SR) that did demonstrate statistical significance suffers from the potential of a false determination of efficacy, in the absence of a correlation with validated, standardized psychiatric measures of effectiveness. The revised primary efficacy comparison of the pivotal D02 clinical study to the observational D04 control study (after the acute study failed to reach its primary efficacy endpoint) also has a number of deficiencies, including the chief limitation that the data were not derived from a randomized subject data set, but rather a comparison of outcomes from an investigational study and observational control and significantly different management of patients during the first 12 months. In the presence of the above listed deficiencies, it is puzzling what conclusions can be drawn from the studies collectively.

The use of a prospective, randomized, controlled trial with standardized outcome tools and independent objective outcome tools is an important study design, and should not be dismissed based solely on the unmet need of this patient population for effective

therapies. One of the tasks of randomization is obtaining two study groups that are not significantly different from each other. Not only are there significant differences in baseline psychiatric characteristics between the primary efficacy comparative analyses between D02 and D04 (in this non randomized data set), there also exists other patient variables that have not even been measured and significant differences in patient management, scheduled visits, and follow-up. The randomized controlled trial design is very time consuming and expends a great deal of resources. Nevertheless, the value of such studies is such that they can serve as the gold standard for medical practice, replacing the current data set, including a failed pivotal acute study and a series of non-randomized, uncontrolled open-label comparative analyses.

From a scientific standpoint, there are several serious limitations to the clinical data set submitted that the Sponsor cannot address, other than by providing data from a new, scientifically sound, randomized, controlled study, which addresses concomitant treatment use and includes adequate safety assessments in both the treatment and control group (new clinical trial designs have been suggested earlier in the review memo). Any proposed mood disorder therapy would need to have evidence to establish effectiveness and safety for FDA approval. I recommend the VNS Therapy System not be approved for the proposed indications for treatment-resistant depression, based on the belief that the Sponsor has not scientifically demonstrated a reasonable assurance of safety or effectiveness, nor adequate indications or instructions for use.

Team Leader Concurrence: \_\_\_\_\_ 01.10.05

Branch Chief Concurrence: \_\_\_\_\_ 1/10/05

Deputy Division Director Concurrence: \_\_\_\_\_ 1/10/05

Division Director Concurrence: \_\_\_\_\_ 1/10/05

**References**

Charney et al., National Depressive and Manic-Depressive Association Consensus Statement on the Use of Placebo in Clinical Trials of Mood Disorders. Arch Gen Psych, 2002; 59:262-270.

Fritze and Moller, Design of Clinical Trials of Antidepressants. CNS Drugs, 2001; 15(10): 755-764.

*I concur with the not approvable recommendation.  
ODE Office Director*



Sackeim et al., Vagus Nerve Stimulation for Treatment-Resistant Depression: Efficacy, Side Effects, and Predictors of Outcome. *Neuropsychopharmacology* 2001; 25: 713-728.

Sacks et al., Randomized versus historical controls for clinical trials. *American Journal of Medicine*, 1982;72:233-240.

Sacks et al., General principles for evaluation of new interventional technologies and devices, 2003; 14:S391-S394

Souery et al., Treatment resistant depression: Methodological overview and operational criteria. *Eur Neuropsych*, 1999; 9:83-91.

Thase and Rush, Treatment-resistant depression. *Psychopharmacology*, 1995; Chapter 92:1081-1097.

Trivedi et al., Clinical results for patients with major depressive disorder in the Texas medication algorithm project. *Arch Gen Psychiatry*, 2004;61:669-680.

**Memo to File****From:** CDRH Director**Date:** June 12, 2005**Cyberonics VNS System for Treatment Resistant Depression****P970003/S50****INDICATIONS:**

The VNS Therapy System is indicated for the adjunctive long-term treatment of chronic or recurrent depression for patients 18 years of age or older who are experiencing a major depressive episode that has not had an adequate response to four or more adequate antidepressant treatments.

**DEVICE DESCRIPTION:**

The VNS Therapy System used for vagus nerve stimulation (VNS), consists of the implantable VNS Therapy Pulse Generator, the VNS Therapy Lead and the external programming system used to change stimulation settings. The pulse generator is an implantable, multiprogrammable, pulse generator that delivers electrical signals to the vagus nerve. The pulse generator is housed in a hermetically sealed titanium case and is powered by a single battery. Electrical signals are transmitted from the pulse generator to the vagus nerve by the lead. The lead and the pulse generator make up the implantable portion of the VNS Therapy System. The external programming system includes a programming wand, the Model 250 Programming Software, and a compatible computer. The software allows a physician, with the programming wand placed over the implanted pulse generator, to identify, read and change device settings.

**ADMINISTRATIVE HISTORY:**

2003

- 27-Oct PMA received
- 3-Dec Filing Meeting

- 2004
- 26-Jan ODI Director Briefing Meeting (Decision to issue Major Deficiency letter)
  - 4-Feb Day 100 Meeting
  - 1-Mar FDA Major Deficiency Letter Issued
  - 9-Mar FDA Cyberonics Conference Call to discuss Deficiency letter
  - 29-Mar Response to 3/1/04 Major Deficiency letter
  - 15-Jun Panel Meeting
  - 11-Aug Not Approvable letter issued
  - 30-Aug Center Director discussion of options for Cyberonics (Treatment IDE)
  - 23-Sep Response to 8/11/04 Not Approvable letter
  - 1-Dec CDRH and Cyberonics scientific staff and advisors meeting
- 2005
- 2-Feb CDRH Issues Approvable letter
  - 11-Mar Response to 2/2/05 Approvable letter

**Summary of Safety and Effectiveness Data:**

**Feasibility Study D-01**

D-01 was an open-label, nonrandomized, single arm, multicenter, 60-patient study of VNS in treatment-resistant major depression. The study included an acute 12-week phase as well as a subsequent long-term follow-up. Patients were required to maintain a stable antidepressant medication regimen during the acute phase of the study.

The most commonly reported treatment-emergent adverse events, regardless of relationship to stimulation (in order of frequency) were: voice alteration (75%), neck pain (32%), depression (27%), headache (27%), dyspnea (23%), dysphagia (18%), increased cough (17%), nausea (15%), dyspepsia (12%), and dizziness (10%). Seventy-seven (77) events in 38 subjects were rated as serious (10 in acute phase and 67 in long-term follow-up) including 34 reports of worsening depression and 12 suicide attempts or overdose.

Fifty-nine of the 60 subjects completed the 12-week acute phase and were available for evaluation of effectiveness. Primary efficacy analysis of the 28-item Hamilton Rating

Scale for Depression (HRSD<sub>28</sub>) at the end of this phase showed 18 (31%) of the 59 evaluable subjects met response criteria ( $\geq 50\%$  reduction in score as compared to baseline). In addition, 25 of 55 (45%) were responders after one year, and 18 of 42 (43%) after two years. Furthermore, after one year of stimulation, 13 of the 18 acute responders (72%) maintained their response and 12 of the acute non-responders (29%) became responders. Of the subjects included in the evaluable population, 15%, 27% and 21% reached remission (HRSD<sub>28</sub>  $\leq 10$ ) at 12 weeks, 1 year, and 2 years, respectively.

#### Pivotal D-02 Study and D-02/D-04 Comparison Study

A pivotal clinical trial of 235 subjects (D-02) was conducted by the sponsor to evaluate the safety and effectiveness of the device for the intended use. The number (and percentage) of subjects reporting an adverse event during the 0-3 month period and during the 9-12 month period is depicted in Table 1 below.

**Table 1 – Adverse Events Associated With VNS Therapy at 0-3 Months and 9-12 Months**

Adverse Event	0-3 Months (N=232)	9-12 Months (N=209)
Voice Alteration	135 (58.2%)	113 (54.1%)
Increased Cough	55 (23.7%)	13 (6.2%)
Neck Pain	38 (16.4%)	27 (12.9%)
Dyspnea	33 (14.2%)	34 (16.3%)
Dysphagia	31 (13.4%)	9 (4.3%)
Paresthesia	26 (11.2%)	9 (4.3%)
Laryngismus	23 (9.9%)	10 (4.8%)
Pharyngitis	14 (6.0%)	11 (5.3%)
Nausea	13 (5.6%)	4 (1.9%)
Pain	13 (5.6%)	13 (6.2%)
Headache	12 (5.2%)	8 (3.8%)
Insomnia	10 (4.3%)	2 (1.0%)
Palpitation	9 (3.9%)	6 (2.9%)
Chest Pain	9 (3.9%)	4 (1.9%)
Dyspepsia	8 (3.4%)	4 (1.9%)
Hypertonia	6 (2.6%)	10 (4.8%)
Hypesthesia	6 (2.6%)	2 (1.0%)
Anxiety	5 (2.2%)	6 (2.9%)
Ear Pain	5 (2.2%)	6 (2.9%)

Fructation	4 (1.7%)	0
Diarrhea	4 (1.7%)	2 (1.0%)
Dizziness	4 (1.7%)	3 (1.4%)
Incision Site Reaction	4 (1.7%)	2 (1.0%)
Asthma	4 (1.7%)	3 (1.4%)
Device Site Reaction	4 (1.7%)	0
Device Site Pain	4 (1.7%)	2 (1.0%)
Migraine Headache	4 (1.7%)	2 (1.0%)

In the D-02 long-term phase there were 96 SAE. These events are shown in Table 5 below. SAE in the Long-Term Phase of D-02

**Table 5 – Serious Adverse Events in Long-Term D-02**

Event	# of Events	# Subjects
Worsening Depression	62	31
Suicide Attempt	7	6
Syncope	4	3
Convulsion	2	2
GI Disorder	2	2
Sudden Unexplained Death	1	1
Chest Pain, Abdominal Pain, Peritonitis, Cholecystitis, Constipation, Dehydration, Dizziness, Drug Dependence, Manic Depression, Somnolence, Abnormal Thinking, Overdose, Accidental Injury, Breast CA, Wound Infection, Surgical Procedure, Enlarged Uterine Fibroid, Cholelithiasis	1 each (18)	18

D-04 was a long-term, observational, prospective study designed to collect data regarding usual standard-of-care (SOC) treatment for TRD in people who were in a major depressive episode at the time of admission. The usual SOC was defined as the treatment strategy the physician and subject chose to follow. Clinical depression assessments and quality of life outcomes were assessed at baseline, 3, 6, 9 and 12 months. D-04 was intended to provide a comparison group for the D-02 long-term analysis. *Safety data were not prospectively collected in D-04.*

#### Deaths

Four deaths were reported. One occurred prior to implantation/stimulation. Two deaths occurred after device implantation and prior to the 12 month follow-up. One was a

suicide during the acute phase (in the treatment group) and one was listed as “undetermined” cause. The latter occurred approximately 2-3 months after implantation and stimulation. An additional death occurred after 12 months of follow-up and was due to acute brain injury.

#### **Specific Depression-Related Adverse Events**

##### Mania/Hypomania

The Young Mania Rating Scale (YMRS) was used to detect the emergence of mania in the D-02 study. Three (3) subjects had a manic reaction reported. Another 3 had YMRS > 15 during the long-term phase without an adverse event being reported. Two of the six patients had their event during the acute phase and 5 of the 6 had a prior history of bipolar disorder or mania. One subject’s mania was classified as a serious adverse event.

##### Worsening Depression

In the acute phase there were 12 reports of worsening depression, 5 in the stimulation group [4 of 119 subjects] and 7 in the sham group [7 of 116 subjects]. One of the treatment-group reports occurred prior to stimulation initiation. Following acute phase exit and during the 12-month period of stimulation, 62 events were reported in 31 subjects. The number of episodes of worsening depression per patient ranged from 1 to 6.

##### Suicidal Ideation and Suicide.

One way in which the sponsor analyzed change in suicidal ideation was to look at Item 3 of the HRSD<sub>24</sub> score. During the acute D-02 study, 2.6% of sham subjects and 1.7% of the stimulation subjects increased their Item 3 score by 2 or more points. During the long-term D-02 phase, 2.8% of subjects had increased their Item 3 score by at least 2 points at 12 months versus baseline. In the D-04 group, this was 1.9%. Conversely, 27% of D-02 subjects decreased their score by at least 2 points at 12 months compared to baseline whereas only 9% of D-04 subjects did.

## **D02 and D04 Study Accountability and Subject Population**

### D02 Subject Accountability

Of the 235 subjects who were enrolled and randomized in the Acute D-02 study, 2 subjects withdrew during the acute phase (including 1 suicide), 2 additional subjects did not complete the acute study, and 9 were either protocol violations or failed to meet Visit 2 continuation criteria. Therefore, at the end of the acute phase of the D-02 study, 222 subjects were evaluable for effectiveness with 112 from the treatment group and 110 from the sham-control group.

A total of 233 subjects entered the long-term phase of D-02. During this phase, 28 subjects were deemed to be not evaluable for effectiveness for the following reasons:

- No effectiveness data included at any long-term visit 4
- Did not meet acute phase continuation criteria 3
- Did not have acute exit HRSJD score  $\geq 18$  if in sham group 21

A total of 205 subjects were therefore *evaluable* for effectiveness at the end of the D-02 long-term phase study (110 from the original treatment group and 95 from the original sham group) and 209 were evaluable for safety. Of these, 28 did not complete 12 months of follow-up for the following reasons:

- Withdrew before 1 year of stimulation 17
- Reached 1 year but device was ON < 80% of time 6
- Did not have 1 year assessments/records 5

The most common reason cited for early withdrawal was lack of effectiveness. In the end 177 *12-month stimulation completers* (103 from the original stimulation group and 74 from the original sham group) contributed to the effectiveness analysis for the long-term D-02 and D-02/D-04 comparison.

### D04 Subject Accountability

For the D04 study, 138 subjects were enrolled. Of these, 11 discontinued and 3 only provided baseline data. As such, 124 subjects were included in the *evaluable* population for this portion of the study. Of these 124, 112 were 12-month *completers* which provided effectiveness data.

#### **D02 Long-Term Phase**

The primary endpoint for the evaluation of the long-term phase of D-02 was a repeated measures linear regression analysis performed on the raw HAM-D scores during the first 12 months after initiation of stimulation on the 12 month completer population. This was calculated as the average of the slopes across the 4 quarters with each quarter having equal weight. As a secondary endpoint, similar data was assessed using the IDS-SR scale. These results are shown in Table 6.

**Table 6. D-02 Long-Term Primary Effectiveness Results**

	<b>N</b>	<b>Slope</b>	<b>p-value</b>
12-Month Completer Population	177		
HAM-D		-0.47/month	<0.001
IDS-SR		-0.55/month	<0.001
12-Month Evaluable Population	205		
HAM-D		-0.45/month	<0.001
IDS-SR		-0.52/month	<0.001
12-Month Intent-to-Treat Population	231		
HAM-D		-0.40/month	<0.001
IDS-SR		-0.45/month	<0.001

#### **Sustained Response**

The evaluable population was assessed over the last 4 visits of the first year (months 9, 10, 11, and 12) to ascertain which subjects were "sustained responders" (defined as  $\geq 1$  visit with  $\geq 50\%$  response and at least an additional 2 visits with  $\geq 40\%$  response). Using this definition, 27% (47/177) of the 12-month completer population were considered sustained responders.



### D02/D04 Comparisons

The efficacy analysis for the D02-D04 comparative analysis was the comparison of the change over time (slope) of the IDS-SR raw scores across 12-months with a repeated measures linear regression model. A statistically significant difference ( $p < 0.001$ ) was demonstrated in the estimated IDS-SR raw scores per month between the D02 and D04 evaluable populations (-0.397 estimated average difference per month). The outcome result is presented graphically in Figure 2 below.

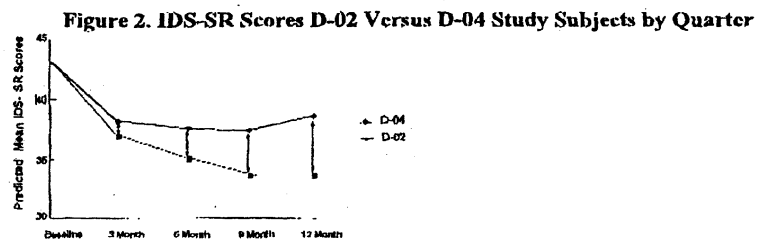

Baseline demographic and illness characteristic differences were controlled in the repeated measures linear regression analysis by incorporating the 5-level grouped propensity score. This 5-level grouped propensity score did not contribute to the statistical significance of the outcome ( $p = 0.831$ ). Based on this analysis, the observed baseline demographic and illness characteristics did not contribute to the difference in outcome between the D-02 and D-04 populations.

An additional post-hoc analysis was performed comparing D02 and D04 subjects after censoring the D02 patients at the first time of a significant addition or change in antidepressant treatment and using the IDS score obtained just prior to this change for all subsequent visits. With this analysis, the difference observed in the estimated IDS-SR raw scores per month between D02 and D04 evaluable populations at 12 months was -0.183 which was not statistically significant ( $p = 0.052$ ). In addition, the response rate for the HSRD endpoint decreased from 30% to 19.9%. This censored rate for HSRD was not statistically different from the D04 group response rate (13%,  $p = 0.118$ ). Differences in

response rates using the IDS-SR scale also were not significant after censoring (18% versus 12%,  $p=0.085$ )

### 2-Year Response Rates

The sponsor provided 2-year HRSD effectiveness data on 199 subjects including 42 from D-01 (feasibility) and 157 from D-02 (pivotal) representing 75% of the evaluable subjects and 67% of the implanted patients combined from both studies. Table 11 below shows HRSD response and complete response rates at 24 months as well as 3 and 12 months for evaluable subjects.

**Table 11. Evaluable D-01 and D-02 HRSD Response Rates 3-24 Months**

	<b>D-02</b>	<b>D-01</b>	<b>Combined</b>
<b>3 Months</b>	<b>N=205</b>	<b>N=59</b>	<b>N=264</b>
Responder	30 (14.6%)	18 (31%)	48 (18.2%)
Complete Responder	15 (7.3%)	9 (15%)	24 (9.1%)
<b>12 Months</b>	<b>N=181</b>	<b>N=55</b>	<b>N=236</b>
Responder	54 (29.8%)	25 (45%)	79 (33.5%)
Complete Responder	31 (17.1%)	15 (27%)	46 (19.5%)
<b>24 Months</b>	<b>N=157</b>	<b>N=42</b>	<b>N=199</b>
Responder	51 (32.5%)	18 (43%)	69 (34.7%)
Complete Responder	27 (17.2%)	9 (21%)	36 (18.1%)

### New Analysis of Medication Changes

The sponsor performed an additional analysis on antidepressant medications in D-02 subjects. For this analysis, evaluable subjects with an increase in antidepressant medication were compared to subjects who had no increase in antidepressant medication. A total of 48 evaluable subjects had no increase in antidepressant medication while 157 did have an increase over one year of VNS therapy. At 12 months, 50% of the subjects without increase in medications were responders as compared to 23% of the subjects who did have an increase in medications.

### 2-Year Therapy Continuation Rates

At one year, 98% (59/60) of D-01 subjects and 90% (211/235) of D-02 subjects continued to receive VNS therapy. At 2 years, 87% (52/60) of D-01 subjects and 81% (190/235) of D-02 subjects continued with VNS therapy.

#### **Advisory Panel Recommendation**

On June 15, 2004, the Neurological Devices Panel, by a vote of 5-2, recommended that the Pre-Market Approval Application (PMA) for the VNS Therapy System for the treatment of chronic or recurrent treatment-resistant depression be found approvable with the following conditions:

1. Patients should have failed four or more trials of traditional treatment modalities for treatment-resistant depression (medications and ECT) prior to use of the device.
2. The device be implanted by surgeons with appropriate training.
3. Training regarding device electronic programming be provided for primary care providers.
4. Additional patient labeling for use of the device and identification card be provided.
5. A patient registry to collect clinical data be established.
6. The physician labeling be revised regarding the following: 12 month open label follow-up, the variable effect of treatment, patient selection, and deletion of imaging claims.

The panel considered a number of factors in reaching their conclusions including the illness itself with its attendant mortality and morbidity, the difficulties in treating this particular subset of patients, and the problems related to the design of these trials. The primary reasons for those who recommended approval appear to have been the long-term results, the target population, and the lack of viable alternatives for a significant portion of that population. The primary concern of those who voted against approval was the lack of a randomized controlled trial demonstrating effectiveness.

**RELEVANT STATUTE, REGULATION, GUIDANCE:****Statute:****SEC. 515. [360e]**

In making the determination whether to approve or deny the application, the Secretary shall rely on the conditions of use included in the proposed labeling as the basis for determining whether or not there is a reasonable assurance of safety and effectiveness, if the proposed labeling is neither false nor misleading. In determining whether or not such labeling is false or misleading, the Secretary shall fairly evaluate all material facts pertinent to the proposed labeling.

**Regulation:****Sec. 860.7 Determination of safety and effectiveness.**

(b) In determining the safety and effectiveness of a device for purposes of classification, establishment of performance standards for class II devices, and premarket approval of class III devices, the Commissioner and the classification panels will consider the following, among other relevant factors:

- (1) The persons for whose use the device is represented or intended;
- (2) The conditions of use for the device, including conditions of use prescribed, recommended, or suggested in the labeling or advertising of the device, and other intended conditions of use;
- (3) The probable benefit to health from the use of the device weighed against any probable injury or illness from such use; and
- (4) The reliability of the device.

(c)(1) Although the manufacturer may submit any form of evidence to the Food and Drug Administration in an attempt to substantiate the safety and effectiveness of a device, the agency relies upon only valid scientific evidence to determine whether there is reasonable assurance that the device is safe and effective. After considering the nature of the device and the rules in this section, the Commissioner will determine whether the evidence submitted or otherwise available to the Commissioner is valid scientific evidence for the purpose of determining the safety or effectiveness of a particular device and whether the available evidence, when taken as a whole, is adequate to support a determination that there is reasonable assurance that the device is safe and effective for its conditions of use.

(2) Valid scientific evidence is evidence from well-controlled investigations, partially controlled studies, studies and objective trials without matched controls, well-

documented case histories conducted by qualified experts, and reports of significant human experience with a marketed device, from which it can fairly and responsibly be concluded by qualified experts that there is reasonable assurance of the safety and effectiveness of a device under its conditions of use. *The evidence required may vary according to the characteristics of the device, its conditions of use, the existence and adequacy of warnings and other restrictions, and the extent of experience with its use.* Isolated case reports, random experience, reports lacking sufficient details to permit scientific evaluation, and unsubstantiated opinions are not regarded as valid scientific evidence to show safety or effectiveness. Such information may be considered, however, in identifying a device the safety and effectiveness of which is questionable.

(d)(1) There is reasonable assurance that a device is safe when it can be determined, based upon valid scientific evidence, that the probable benefits to health from use of the device for its intended uses and conditions of use, when accompanied by adequate directions and warnings against unsafe use, outweigh any probable risks. The valid scientific evidence used to determine the safety of a device shall adequately demonstrate the absence of unreasonable risk of illness or injury associated with the use of the device for its intended uses and conditions of use.

(e)(1) There is reasonable assurance that a device is effective when it can be determined, based upon valid scientific evidence, that in a significant portion of the target population, the use of the device for its intended uses and conditions of use, when accompanied by adequate directions for use and warnings against unsafe use, will provide clinically significant results.

**Guidance:**

**IV. How do the Least Burdensome Principles Apply to PMAs (Originals and Supplements)?**

FDA and industry should focus on the statutory criteria for approval of the PMA, i.e., the determination of reasonable assurance of safety and effectiveness, as defined in the regulations (21 CFR 860.7). This determination should be based on valid scientific evidence, and information unrelated to the premarket approval decision should not be submitted to, nor requested by, the Agency.

Most original PMAs and some supplements require clinical data in order to meet the statutory threshold for approval. Where clinical outcome can be reliably predicted from non-clinical data, however, well-designed bench and/or animal testing can be the basis for approval of the PMA. Conditions where such non-clinical data could meet the threshold for approval typically involve devices or modifications of approved devices for which scientifically valid information is available in the public domain. If clinical data are needed, FDA and industry should consider alternatives to randomized, controlled clinical trials when potential bias associated with alternative controls can be addressed.

Given the above, alternatives to randomized, controlled clinical trials may include:

- Reliance on valid<sup>2</sup> non-U.S. data (where appropriate for the intended U.S. patient population),
- “Paper PMAs,”<sup>3</sup> or
- Study designs employing non-concurrent controls, such as historical controls (e.g., literature, patient records), objective performance criteria (OPC)<sup>4</sup>, and patients as their own control.

In addition, when clinical data are needed for PMA approval, the use of scientifically valid surrogate endpoints and statistical methods, such as Bayesian analyses,<sup>5</sup> should be considered to determine if they may be appropriately used. If incorporated as part of the study design, early submission of the application may also be considered, as appropriate.

Whenever possible, FDA and industry decisions about device development and review should rely on information that is available from earlier versions of the same device or from marketing experience with similar devices. Recognizing that devices often develop incrementally, earlier generations of a product line may provide important information that can reduce the need for, or the amount of, new additional data. Therefore, information gathered throughout a product’s life cycle may also help reduce submission data requirements.

**The role of postmarketing information should be considered in determining the appropriate type and amount of data that should be collected in the premarket setting to support PMA approval. Postmarketing information should also be considered for assuring long-term device safety and effectiveness, wherever appropriate. Discussions regarding the premarket/postmarket balance should occur early in the device development process with the understanding that the statutory criterion for approval continues to be reasonable assurance of safety and effectiveness.**

#### **DISCUSSION, CONCLUSION AND DECISION:**

My review of this PMA supplement is based on an evaluation of the relevant statutory and regulatory requirements, the scientific data provided by the sponsor and the evaluation of that data by our own review staff and advisory panel, and the potential impact that this therapy could have on public health.

In making my final decision, I attempted to balance the scientific concerns raised by the reviewing division and the Office of Device Evaluation with the recommendation of the advisory panel, my own review of the data and discussion between the sponsor’s scientific experts and FDA scientific experts, my best judgment of how the relevant

statute, regulation and guidance apply and ultimately how to best serve the needs of those individuals who may choose this therapeutic option to treat a severe, and in some cases, life-threatening medical condition.

The D1 study was a feasibility study that showed adequate safety and some degree of promise regarding effectiveness. The randomized portion of the D2 study failed to show a statistical difference between patients in the active arm and sham controls. This part of the study looked at patients out to 12 weeks post-implantation.

At that juncture the sponsor chose to pursue a non-randomized comparison of the D2 patients including those from the active arm and those from the sham group who were crossed over to active treatment with VNS plus standard psychiatric care and a prospectively enrolled cohort of TRD patients who were treated with standard psychiatric care including medication, ECT, and psychotherapy. The sponsor chose a one year endpoint to evaluate the D2 patients relative to their own baseline status and to compare the D2 to the D4 cohort.

Subject accountability for the both the D2 and D4 cohorts were provided for all patients enrolled in the studies. Reasons for patient withdrawal and an extensive analysis of demographic similarities and differences were also provided.

Safety data was provided for the D2 study and analyzed several different ways according to frequency, severity, etiology, time of occurrence and duration. Voice alteration was by far the most common and most persistent AE, followed by a number of respiratory and digestive effects of VNS and a significant number of individuals who reported persistent neck pain out to one year. Of greater concern is the number of serious adverse events which included worsening depression and suicide and four deaths. The analysis of worsening depression includes a comparison of subjects in the acute randomized phase which appears to show that there was no difference between those who received and those who did not receive stimulation. For the long term phase of the study there were 62 events noted in 31 patients for which no direct comparator is available. A surrogate of

psych-related hospitalizations did not appear to demonstrate a significant difference between D2 and D4. Similarly with respect to suicidal ideation, attempts and suicide, there were no notable differences in the acute phase or significant trends noted in the long-term phase however it should be noted that the numbers are small and once again direct comparison of D2 to D4 could not be provided.

Since this is the same device that is currently approved and marketed for the treatment of severe epilepsy, data from the epilepsy experience, while not directly comparable, are thought to be relevant and do provide a much larger experience with the device. Data from the premarket studies show much the same profile of acute and persistent stimulation-related events as those seen in the TRD studies. MDR data collected from July, 1997 to October 2004 reflect a marketing experience of over 32,000 implants and 80,000 device years. A total of 524 deaths were reported including 102 (20%) of "unknown cause." A total of 1644 serious injuries were also reported including 525 infections, 40% of which are known to have required explanation. Other serious ADEs include vagus nerve injury, respiratory and cardiac events. A full description of this data is provided in the SSED and labeling. Of particular concern are the number of deaths of unknown cause and the number of injuries requiring explant. While it is difficult to draw direct comparison of these data to the other studies of patients with severe epilepsy and even more difficult to postulate how predictive they are of the risk profile for the TRD population, they are certainly data which should be taken into consideration by patients and physicians considering this treatment option. These data also mandate the need for close monitoring of the TRD population both by the sponsor and FDA.

With regard to effectiveness, I think it needs to be stated clearly and unambiguously that the short-term randomized comparison of VNS active to VNS sham at 12 weeks failed to reach, or even come close to reaching, statistical significance with respect to its primary endpoint. I think that one has to conclude that, based on that data; either the device has no effect, or, if it does have an effect that in order to measure that effect a longer period of follow-up is required.



The question then becomes whether or not one should look beyond that single data point to the non-randomized long-term portion of the D2 study and to the D2/D4 comparative data. I believe that medical device statute, regulation, and guidance all support the concept that data from a variety of sources and methods of analysis can and should be considered in making regulatory decisions and that those sources should be evaluated specifically with regard to the device and the clinical impact of that device in its target population. As stated in regulation, "*The evidence required may vary according to the characteristics of the device, its conditions of use, the existence and adequacy of warnings and other restrictions, and the extent of experience with its use.*" It is with that in mind that I examined the totality of the data considering the strengths and weaknesses of the individual components.

First, as I mentioned above, I think that the issue of patient accountability and follow-up is extremely important especially for this type of longitudinal analysis. The number of evaluable D2 and D1 patients at 3 months, 12 months, and 24 months (Table 11), as well as the number of patients in the matched control D4 followed to 12 months is quite impressive.

The issues of lack of blinding and lack of a randomized control for the long-term study are real and significant and as was stated in the review team leader's memo, "One cannot replace the concept of randomization, especially for all of the variables that were either not measured or not considered when comparing the investigational study and the observational control study." While I would certainly agree that randomization cannot be replaced, the ability to derive useful data from a non-randomized study is, I believe, dependent on the diligence applied, and ultimately the degree to which, potential sources of bias are mitigated. I think that the sponsor did a reasonable job in providing a matched control (Table 2) and the propensity analysis provided some assurance that, at least with respect to known variables, the differences between the two populations in aggregate were not statistically significant or clinically meaningful.

**Table 2. D02, D04 Comparison of Demographics (Evaluable Subjects)**

Parameter	Statistic	D02 (N=205)	D04 (N=124)
Age (years)	Mean	46.3	45.5
Male	N (%)	74(36)	39(31)
Female	N (%)	131(64)	85(69)
Caucasian	N (%)	198(97)	111(90)*
African-American	N (%)	3(1)	5(4)
Hispanic	N (%)	3(1)	2(2)
Unipolar	N (%)	185(90)	109(88)
Bipolar	N (%)	20(10)	15(12)
Recurrent	N (%)	161(87)	93(85)
Single Episode	N (%)	24(13)	16(15)
Length of Current MDI (mos)	Mean (S.D.)	49.9(52.1)	68.6(91.5)
# Failed Trials in Current MDI	Mean (S.D.)	3.5(1.3)	3.5(1.3)
Received ECT Lifetime	N(%)	108(53%)	32(26%)*
Received ECT, Current MDF	N(%)	72(35%)	15(12%)*
Duration of Illness (yrs)	Mean (S.D.)	25.5(11.9)	25.8(13.2)
Lifetime episodes of Depression			*
0-2	N(%)	50(24)	31(25)
3-5	N(%)	69(34)	36(29)
6-10	N(%)	56(27)	18(15)
>10	N(%)	19(9)	32(26)
No Suicide Attempts in Lifetime	N(%)	140(68)	80(65)
Treatment induced (hypo)mania	N(%)	16(8)	6(5)
Hospitalizations for Depression	Mean (S.D.)	2.7(5.4)	2.1(2.9)
ECT Treatment Within past 2yrs	N(%)	54(26)	19(15)

\* p&lt;0.05.

The D2/ D4 linear regression comparative data of IDS-SR scores (Figure 2) do show a statistically significant difference which was maintained using all subjects with data. Several additional comparative analyses between D2 and D4 using HRSD scores also showed statistical differences and a relatively conservative analysis censored for concomitant treatments, approached significant with a p value of 0.052. What I do find more significant with regard to the comparative analyses than the various p values is the shape of the curves in Figure 2, which I believe, is consistent with the idea that the effectiveness of this therapy, perhaps unlike other treatments for depression, does improve over time.

Again, the question arises, how much of these differences can be attributed to the device, and how much to confounding variables both known, such as lack of blinding, and

unknown. While the majority of the advisory panel were persuaded, based on the one year data, that this therapy does have a clinically beneficial effect on a meaningful proportion of this target population, and I also believe that the numbers of statistically significant measures along with the fact that others are close to significance and all measures trend in a positive direction makes it highly unlikely that all of this is due chance and/or bias, what I believe is most compelling is the supplemental 2 year data in presented in Table 11.

**Table 11. Evaluable D-01 and D-02 HRSD Response Rates 3-24 Months**

	<b>D-02</b>	<b>D-01</b>	<b>Combined</b>
<b>3 Months</b>	<b>N=205</b>	<b>N=59</b>	<b>N=264</b>
Responder	30 (14.6%)	18 (31%)	48 (18.2%)
Complete Responder	15 (7.3%)	9 (15%)	24 (9.1%)
<b>12 Months</b>	<b>N=181</b>	<b>N=55</b>	<b>N=236</b>
Responder	54 (29.8%)	25 (45%)	79 (33.5%)
Complete Responder	31 (17.1%)	15 (27%)	46 (19.5%)
<b>24 Months</b>	<b>N=157</b>	<b>N=42</b>	<b>N=199</b>
<b>Responder</b>	<b>51 (32.5%)</b>	<b>18 (43%)</b>	<b>69 (34.7%)</b>
<b>Complete Responder</b>	<b>27 (17.2%)</b>	<b>9 (21%)</b>	<b>36 (18.1%)</b>

I think that the degree of consistency in response rates comparing the individual cohort responses at 12 and 24 months as well as the consistency between the D2, D1, and combined cohorts over time provides reasonable assurance that can be translated into labeling regarding the level of effectiveness that can be expected using this device for this indication.

As discussed in the Least burdensome Guidance, "The role of postmarketing information should be considered in determining the appropriate type and amount of data that should be collected in the premarket setting to support PMA approval." Clearly, there is additional information that can and should be collected and reported regarding the use of VNS for treatment resistant depression. I believe that having satisfied the statutory requirement for reasonable assurance of safety and effectiveness, it is appropriate both from a regulatory and from a scientific standpoint for that information to be collected postmarket. Depression, especially the severe treatment resistant variety that is the subject of this submission, is a chronic disease for which long-term data is indicated. In

addition, as has been previously discussed, the major benefit of VNS does appear to be its long-term sustainability. Therefore, the Post-Market Plan (see attached), is designed, based on extensive interaction between the sponsor and FDA, to gather additional long-term data for safety monitoring, specific data on safety and effectiveness over a five year period, and to collect additional data on different dosing levels to provide physicians with better information in order to refine treatment strategies and optimize individual patient outcomes. The plan also includes a strategy for monitoring, reporting, and analysis of results.

In conclusion, I do believe that the sponsor has provided reasonable assurance of safety and effectiveness based on valid scientific evidence as required by statute and regulation for the approval of a Class III medical device. I have come to this conclusion, notwithstanding valid concerns regarding the lack of a randomized controlled trial demonstrating safety and effectiveness, because the sponsor has provided data that were systematically collected and analyzed which showed significant improvement from baseline over one and two years for a definable subset of the target population, and comparative data against a reasonably matched control which also showed sustained improvement over time.

There were four issues to be addressed in the Approvable letter dated February 2, 2005:

1. Agreement on a postmarket investigational plan. This plan has been submitted and finalized to include two studies, a 1 year comparative dosing study of approximately 450 patients and a 5 year patient registry which will include a minimum of 1000 TRD patients receiving adjunctive VNS therapy and approximately 1000 TRD patients not receiving VNS. The plan also includes monitoring and reporting requirements, DSMB, and BIMO auditing.
2. Agreement on physician and patient labeling. Labeling has undergone extensive review and modification to ensure that it fully informs physicians and patients of all known risks identified with use of the device in the TRD population as well as MDR information from the marketing experience for the epilepsy indication. Effectiveness information conforms to the information presented in the Summary of Safety and

Effectiveness clearly indicating that benefit is not universal and requires long-term use and supervised management.

3. Satisfactory responses to all outstanding bioresearch monitoring issues. Responses to BIMO issues have been provided and determined to be satisfactory by the Office of Compliance.

4. Compliance with applicable requirements of the Quality System Regulation. The sponsor was inspected July through September 2004. A Warning Letter was issued in December, 2004 that required the sponsor to address the following QS Regulation and other deficiencies:

- Adverse event reporting;
- Design validation;
- Corrective and preventive actions; and
- Complaint handling.

The sponsor responded in writing to deficiencies in January and February, 2005 and those responses were judged satisfactory by the Dallas District. As is customary, although not always mandatory, prior to approval of a pending submission on the same or similar device, the District performed a reinspection of the Cyberonics facility specifically to verify that the corrective actions proposed in Cyberonics' response to the Warning Letter had, in fact, been implemented. That inspection was deemed satisfactory and no additional corrective actions were imposed.

The sponsor has, therefore, met the requirements for providing valid scientific evidence to support a reasonable assurance of safety and effectiveness and has adequately addressed each of the outstanding issues delineated in the Approvable letter dated February 2, 2005.

CDRH Final Decision on P970003/S50: Approval



---

---

APPENDIX E—FDA LETTERS

---

---



DEPARTMENT OF HEALTH &amp; HUMAN SERVICES

Public Health Service

DEC 15 2003

Food and Drug Administration  
9200 Corporate Boulevard  
Rockville MD 20850

Director and Senior Counsel, Regulatory Affairs  
Cyberonics, Inc.  
100 Cyberonics Boulevard  
Cyberonics Building  
Houston, Texas 77058

Re: P970003/S050  
VNS Therapy System  
Filed: October 27, 2003

Dear

The Center for Devices and Radiological Health (CDRH) of the Food and Drug Administration (FDA) has completed an initial review of your premarket approval application (PMA) supplement. We are pleased to inform you that we have made a threshold determination that the PMA supplement is sufficiently complete to permit a substantive review and is, therefore, suitable for filing. The filing date is October 27, 2003, which is the date of CDRH receipt of the PMA supplement.

We are also pleased to inform you that your application will receive expedited processing. Expedited review status was granted for the following reason:

Expedited review status was granted because we believe the VNS Therapy System has the potential of providing therapeutic benefits for this indication, in the treatment of patients who are intolerant or resistant to other legally marketed therapies.

You are reminded that it is imperative that the information used to support an application for expedited review meet the requirements of valid scientific evidence (21 CFR 860.7). This evidence would generally be obtained from well-designed, -monitored, and -controlled clinical trials so that the true merit of the medical device might be evaluated as promptly and efficiently as possible. You are further advised that the granting of expedited review status does not guarantee that the application will ultimately be approved.

This letter reflects the current progress of our administrative and limited scientific review of your application. Please be advised that the decision to file the PMA does not imply that either an in-depth evaluation of the safety and effectiveness of the device has been performed or a decision about the approvability of the application has been made. Rather, it represents a decision by CDRH that the application is sufficiently complete to begin the substantive review process. Further review of your application may result in deficiencies which will be communicated to you.



Page 2

Following receipt of a filing letter, an applicant is required by 21 CFR 814.20(e) to update its pending PMA supplement 3 months after the filing date with new safety and effectiveness information learned about the device from ongoing or completed studies when the information may reasonably affect an evaluation of the safety or effectiveness of the device or that may reasonably affect the statement of contraindications, warnings, precautions and adverse reactions in the draft labeling.

This updated reporting is limited to studies sponsored by the applicant or to which the applicant has reasonable access. The update report should be consistent with the data reporting provisions of the protocol. Please submit clinical updates in three copies as an amendment to the PMA supplement and include the FDA reference number assigned to the PMA supplement.

A meeting of the Neurological Devices Panel will be held at which your PMA supplement will be reviewed. You will be notified of the location and date of this meeting. Any additional information to be included in your PMA supplement should be submitted in the form of a PMA supplement amendment and be received by FDA at least 6 weeks in advance of the scheduled advisory panel meeting in order for FDA and the panel members to have adequate time to review the new information. Information received by CDRH less than 6 weeks in advance of a scheduled advisory panel meeting will not be considered or reviewed at the meeting and may delay consideration of your PMA supplement until a subsequent advisory panel meeting.

For your information, there is an industry representative on this FDA advisory panel whose name, address and telephone number you can obtain by contacting the Committee Management Staff at (301) 594-1283. CDRH believes that industry representatives will be better prepared to participate in panel discussions if they have been provided with at least a copy of the Summary of Safety and Effectiveness Data for review prior to the panel meeting. In accordance with 21 CFR 14.86(b), all panel members are subject to all rules and regulations adopted by FDA and the committee; therefore, even though the industry representatives usually are not given access to trade secret and confidential, commercial information, they are bound to protect the confidentiality of documents that would be sent to them in preparation for panel review of a PMA. If you would like the industry representative to have access to any portion of your PMA, including the Summary of Safety and Effectiveness Data, please provide a copy to FDA for that purpose. Clearly identify the submission as a purged copy intended for review by the industry representative. Review of your PMA will not be prejudiced if you elect not to provide information for industry representative review.

Page 3

All correspondence regarding this PMA supplement should be submitted in 6 copies in the form of a PMA supplement amendment. Please address all submissions to:

PMA Document Mail Center (HFZ-401)  
Center for Devices and Radiological Health  
Food and Drug Administration  
9200 Corporate Blvd.  
Rockville, Maryland 20850

If you have any questions regarding this letter, please contact \_\_\_\_\_ at \_\_\_\_\_

Sincerely yours,

Director  
Division of General, Restorative  
and Neurological Devices  
Office of Device Evaluation  
Center for Devices and Radiological Health



DEPARTMENT OF HEALTH &amp; HUMAN SERVICES

Public Health Service

MAR - 1 2004

Food and Drug Administration  
9200 Corporate Boulevard  
Rockville MD 20850

Director and Senior Counsel, Regulatory Affairs  
Cyberonics, Inc.  
100 Cyberonics Boulevard  
Houston Texas 77058

Re: P970003/S050  
VNS Therapy System  
Filed: October 27, 2003  
Amended: December 4 and 19, 2003, and February 17, 2004

Dear

The Center for Devices and Radiological Health (CDRH) of the Food and Drug Administration (FDA) has completed an initial scientific review of the above referenced premarket approval application (PMA) supplement. As we informed you during the February 4, 2004, 100 Day Meeting, and previously in our October 4, 2002, IDE correspondence letter, we have serious concerns regarding your revised statistical plan for the D-02 Study and whether the comparison of D-02 and D-04 that you provided would be appropriate to support your new indication for the adjunctive long-term treatment of chronic or recurrent depression for patients who are experiencing a major depressive episode that has not had an adequate response to two or more antidepressant treatments.

We regret to inform you that on the basis of this review, we have concluded that the PMA supplement lacks information needed to complete the review and determine whether there is reasonable assurance that the device is safe and effective for its intended use. Because of this concern, review of the PMA supplement cannot continue and, accordingly, we have listed the following major deficiencies which require the responses as indicated. Please include in your responses, separate analyses for both unipolar and bipolar patient groups. Also, please provide the numerator, denominator, and proportions (numerator/denominator) in all statistical analyses.

1. In your PMA submission, you have submitted a comparison of results from D-02 and D-04 for effectiveness. A comparison of results from D-02 and D-04 for safety was not provided since safety data were not systematically collected during the D-04 study. Please address the following:
  - a. It is unclear whether completed and attempted suicide rates are greater with VNS Therapy, than completed and attempted suicide rates for standard-of-care treatment alone. Please provide completed and attempted suicide rates for implanted patients in D-02 and for all implanted patients combined in D-01, D-02, and D-03, and compare and justify your comparison to those found in published literature.

Page 2

- b. You reported in D-02, three subjects having adverse events of manic reaction or manic depressive reaction and another three subjects having Young Mania Rating Scale (YMRS) scores > 15 during the long-term phase without an adverse event being reported. You state the D-02 incidence of manic/hypomanic reaction is not unexpected in a bipolar population (N=25), given that 5 out of 6 subjects with the manic/hypomanic reactions had a history of bipolar disorder. Please provide the incidence of manic/hypomanic reaction (e.g., adverse event reporting, data from YMRS scores when available) for all bipolar patients across D-01, D-02, and D-03, and compare and justify your comparison to those found in published literature. Also, please provide published literature supporting your statement that the incidence of manic/hypomanic reaction is not unexpected.
        - c. One of the most common serious adverse events was worsening depression during the D-02 acute phase of study, D-02 long-term phase, and D-02 after cut-off date of 10/10/02. You state most of the serious adverse events described were not considered by the investigator or Sponsor to be related to VNS Therapy. Please explain how most of the serious adverse events described in your submission were not considered by the investigator or Sponsor to be related to VNS therapy, considering comparative safety data were not systematically collected during the long-term D-04 study.
2. Please perform an analysis of the Hamilton Rating Scale for Depression (HAM-D) scores for items 1 and 3 as a separate analysis to examine possible precipitation of depression in D-02, and for all implanted patients combined in D-01, D-02, and D-03, in comparison to possible precipitation of depression in D-04. Please include a comparison of the incidence of patients who start with a HAM-D item 1 or item 3 score of 0 to 1 and then progress to a score of 3 or 4, and compare your results to D-04.
3. Published literature acknowledges the importance of placebo controls in mood disorder studies (Baldwin et al., 2003; Charney et al., 2002; Fritze and Moller, 2001; Walsh et al., 2002). The first consensus statement reported from the National Depressive and Manic-Depressive Association Consensus panel indicates patients with mood disorders have inherently high placebo response rates, and without a placebo (control) or valid alternative method (e.g., add-on studies), most study findings are difficult to interpret (Charney et al., 2002). In your submission, you have provided a failed, short-term (acute), randomized, placebo-controlled (sham treatment-controlled) study, and a prospective, non-randomized, long-term control population (D-04) for comparison to your prospective, non-randomized, long-term D-02 study. Please provide any additional information you may have to address the potential bias from a placebo effect in the long-term D-02 cohort.
4. You note a chief limitation of the D-02/D-04 comparative analysis is that the data are derived from a comparison of subject groups treated with two different interventions rather than from

a randomized subject data set. You have provided a propensity adjustment strategy to reduce potential bias (i.e., patient characteristics, disease characteristics) in your analysis. This propensity adjustment strategy does not address the problems of potential bias due to other patient variables unmeasured in your study, such as past thyroid dysfunction, neurotic pre-morbid personality, familial predisposition for affective disorder, multiple loss events, and socio-cultural level (Souery et al., 1999). Please discuss the impact of these issues on the conclusions drawn from this analysis.

5. You have provided IDS-SR and HAM-D patient data. Please document the concordance between IDS-SR and HAM-D patient data. Please calculate correlation coefficients between IDS-SR and HAM-D scores by each individual patient, and provide pooled estimated correlation coefficient over all patients by appropriate statistical methods. Please also calculate estimated slope and their standard errors between IDS-SR and HAM-D scores for each individual patient and the pooled estimated slope and the standard error over all patients by appropriate statistical methods.
6. Although both D-02 and D-04 were available to enroll subjects at similar time periods, you state almost all D-04 subjects enrolled into the study after D-02 was closed for enrollment, and only 10 D-04 subjects enrolled while D-02 was open. Please provide the number of D-02 subjects that enrolled while D-02 and D-04 were open for enrollment. Also, please provide the decision criteria used to enroll subjects into D-04, rather than D-02, and D-02, rather than D-04, while both D-02 and D-04 were open for enrollment.
7. We believe distinguishing between unipolar and bipolar patients in treatment studies is important towards evaluating the safety and effectiveness of your device. Please provide separate analyses for both unipolar and bipolar depressed patient groups (i.e., IDS-SR primary efficacy analysis, HAM-D secondary efficacy endpoint, and categorical clinical outcome analysis). Please format your analyses according to Tables 10.3.2-1 (IDS-SR Scores D-02/D-04 Comparison), 10.3.2-2 (HAM-D Scores D-02/D-04 Comparison) and Figure 10.3.2-1 (IDS-SR and HAM-D Responders and Complete Responders at 12 months). Please provide the numerator, denominator, and proportions (numerator/denominator) in all statistical analyses and tables. Also, please provide actual numbers of patients analyzed at quarterly follow-up, in your repeated-measure linear regression analyses.
8. Please discuss the clinical significance in average rate of change in the IDS-SR and HAM-D in D-02 and D-04 in unipolar and bipolar patients combined, as well as separately, as it relates to the average rate of change in linear regression analyses for your primary efficacy endpoint, and average rate of change for your secondary efficacy endpoint from baseline to 12 months, respectively. Please include in your response reference to the 12 month completer population, evaluable population, and intent-to-treat population.

Page 4

9. Please discuss the clinical significance between outcomes in D-02 and D-04 in the IDS-SR and HAM-D in unipolar and bipolar patients combined, as well as separately, as it relates to the average rate of change in linear regression analyses for your primary efficacy endpoint, and average rate of change for your secondary efficacy endpoint from baseline to 12 months, respectively. Please include in your response reference to the 12 month completer population, evaluable population, and intent-to-treat population.
10. You have provided a mood medication change summary where you compare responders to non-responders during 12 months of VNS Therapy. Please provide the number of D-02 responders and complete responders who added or increased mood medications by at least one Antidepressant Resistance Rating (ARR) and the number of D-02 responders and complete responders who did not add or increase mood medications by at least one ARR. Also, please provide the number of D-02 non- responders who added or increased mood medications by at least one ARR and the number of D-02 non- responders who did not add or increase mood medications by at least one ARR.
11. In your clinical executive summary, you have provided an analysis of your repeated measures linear regression analysis of IDS-SR scores after censoring the D-02 subjects' scores for concomitant antidepressant treatment changes (i.e., additions or changes in either antidepressant drugs or ECT). Please provide an assessment of categorical clinical outcomes after censoring scores for concomitant antidepressant treatment changes (i.e., additions or changes in either antidepressant drugs or ECT). Please format your analyses according to Figure 10.3.2-1 (IDS-SR and HAM-D Responders and Complete Responders at 12 months).
12. You have not provided an age range for your proposed indication for the adjunctive long-term treatment of chronic or recurrent depression. Please modify your proposed indication to clearly state the minimum age indicated for use. Please provide valid scientific evidence for supporting use of VNS in this age group, or modify your labeling accordingly.
13. In your PMA submission, you have submitted a comparison of results from outcomes during 12 months of VNS therapy plus standard-of-care treatment (D-02) with outcomes from a subset of patients from a multicenter study of electroconvulsive therapy (ECT) in support of effectiveness. Although you state the ECT cohort was well matched for comparison to D-02, the ECT cohort had substantive differences in baseline demographics, trial design, and research settings. Please discuss the impact of substantive differences in baseline demographics, trial design, and research settings upon the comparison of D-02 with outcomes from a subset of patients from a multicenter study of ECT in evaluating safety and effectiveness of your device.
14. Please provide the pre-VNS and 12 month IDS-SR and HAM-D scores as well as categorical clinical outcomes for D-02 and D-04 in tabular format by site for the 12 month completer population, evaluable population, and intent-to-treat population.

15. Please provide a frequency table of raw observed and estimate mean IDS-SR scores and sample sizes (n) at each follow-up as shown below. Also, please specify how many patients are missed at each quarter for both raw observed and the estimated means (repeated measures linear regression).

<u>Study</u>	<u>Baseline</u>	<u>Quarter 1</u>	<u>Quarter 2</u>	<u>Quarter 3</u>	<u>Quarter 4</u>
D-02					
D-04					

16. For each of your seventeen selected patient covariates, please prepare statistical analyses for both before-and-after propensity score adjustment between the D-02 and D-04 patient groups. Please explain the degree of covariate unbalance before propensity score adjustment and covariate balance (or unbalance) after adjustment.
17. In your repeated-measure linear regression analysis for intent-to-treat patient population for D-02/D-04 comparison, your estimated slope (average D-02/D-04 difference in IDS-SR per month) is -0.35. Please explain how you define intent-to-treat analysis in your analyses. Please provide total number of patients observed at each of 12-month follow-up and imputation method used, if any.
18. Please explain and justify your methods for pooling investigator sites into nine pooled sites in your repeated-measure linear regression analyses. In P970003/S050/A002, you have referenced four pooled sites. Please explain the difference between the four pooled sites referenced and nine pooled sites in your repeated-measure linear regression analyses.
19. Please explain your model selection criteria, such as algorithms to including or excluding covariates, and goodness-of-fit test of your fitted logistic regression model.
20. For each covariate, please prepare a graphical display (e.g., Bar chart) of the distributions of propensity score (5 levels here) quintile means (for continuous covariate) or quintile proportions (for binary covariate) between D-02 and D-04 patients, in order to examine bias reduction by your propensity score analyses. Likewise, for each covariate, please perform a 2-way (treatment, 2 levels; and PS quintile, 5 levels) analysis of variance to include main effect (Treatment, quintile) and their interactions. We recommend that you include the predicted propensity scores for each individual patient into your repeated-measures linear regression model, rather than the categorical or class variable (PS with 5 levels) used in your current regression analyses. Also, please justify why no covariate interaction terms were evaluated in your fitted regression models. The above justification of covariate adjustment procedure (via propensity score) is important towards determining whether D-04 may substitute for a randomized, controlled study.

Page 6

21. Since there are small sample sizes, large numbers of centers and covariates, please explain how you treat missing data, in both responses (IDS-SR, HAM-D) and covariates.
22. Please explain 2-way analysis of variance including main effect (treatment, propensity score quintile) and their interactions.
23. Please explain lack of covariate interaction terms evaluation in fitted regression models.

The deficiencies identified above represent the issues that we believe need to be resolved before our review of your PMA application can be completed. In developing the deficiencies, we carefully considered the statutory criteria as defined in Section 515 of the Federal Food, Drug, and Cosmetic Act for determining reasonable assurance of safety and effectiveness of your device. We also considered the burden that may be incurred in your attempt to respond to the deficiencies. We believe that we have considered the least burdensome approach to resolving these issues. If, however, you believe that information is being requested that is not relevant to the regulatory decision or that there is a less burdensome way to resolve the issues, you should follow the procedures outlined in the "A Suggested Approach to Resolving Least Burdensome Issues" document. It is available on our Center webpage at: <http://www.fda.gov/cdrh/modact/leastburdensome.html>

This letter reflects the current progress of our review of your application. Please be advised that further substantive review of your application or any response to this letter may result in additional deficiencies.

This is to advise you that an amendment including the above requested information will be considered a major amendment and may extend the FDA review period up to 180 days. As provided by 21 CFR 814.37(c) you may decline to submit a major amendment requested by

FDA in which case the review period may be extended for the number of days that elapse between the date of such request and the date that FDA receives the written response declining to submit the requested amendment.

As provided under 21 CFR 814.44(g), FDA will consider this PMA supplement to have been voluntarily withdrawn if you fail to respond in writing within 180 days of the date of this request for a PMA supplement amendment. You may, instead, amend the PMA supplement within the 180-day period to request an extension of time to respond. Any such request is subject to FDA approval and must justify the need for the extension and provide a reasonable estimate of when the requested information will be submitted. If you do not amend the PMA supplement within the 180-day period to (1) correct the above deficiencies, or (2) request an extension of time to respond and have the request approved, any amendment submitted after the 180-day period will be considered a resubmission of the PMA supplement and will be assigned a new number. Under these circumstances, any resubmission will be given a new PMA supplement number and will be subject to the requirements of 21 CFR 814.20.



Page 7

You may amend the PMA supplement to provide the above requested information (8 copies), voluntarily withdraw the PMA supplement (3 copies), direct CDRH to complete processing the PMA supplement without the submission of additional information (3 copies) or request an extension. The required copies of the amended PMA supplement should include the FDA reference number for this PMA supplement and should be submitted to the following address:

PMA Document Mail Center (HFZ-401)  
Center for Devices and Radiological Health  
Food and Drug Administration  
9200 Corporate Boulevard  
Rockville, Maryland 20850

Upon receipt of an amendment adequately addressing the above requests or a written response declining to submit the requested amendment, CDRH may schedule an advisory panel meeting to review your PMA supplement. You will be notified of the location and date of this meeting should one be necessary. Any additional information to be included in your PMA supplement should be submitted in the form of a PMA supplement amendment and be received by FDA at least 8 weeks in advance of the scheduled advisory panel meeting in order for FDA and the panel members to have adequate time to review the new information. Information received by CDRH less than 8 weeks in advance of a scheduled advisory panel meeting will not be considered or reviewed at the meeting and may delay consideration of your PMA supplement until a subsequent advisory panel meeting.

If you have any questions concerning this deficiency letter, please contact \_\_\_\_\_ at \_\_\_\_\_

Sincerely yours,

Director  
Division of General, Restorative  
and Neurological Devices  
Office of Device Evaluation  
Center for Devices and  
Radiological Health

References

Baldwin et al., Placebo-controlled studies in depression: Necessary, ethical, and feasible. *Eur Arch Psychiatry Clin Neurosci*, 2003; 253:22-28.

Charney et al., National Depressive and Manic-Depressive Association Consensus Statement on the Use of Placebo in Clinical Trials of Mood Disorders. *Arch Gen Psych*, 2002 Mar; 59:262-270.

Fritze and Moller, Design of Clinical Trials of Antidepressants. *CNS Drugs*. 2001; 15(10): 755-764.

SAS/STAT Software: Changes and Enhancements through Release 6.12 (Chapter 24). SAS Institute, 1997.

Souery et al., Treatment Resistant Depression: Methodological Overview and Operational Criteria. *Eur Neuropsych* 1999; 9:83-91.

Therneau, and Grambsch, *Modeling Survival Analysis Data: Extending the Cox Model*. Springer, 2000.

Walsh et al., Placebo Response in Studies of Major Depression. *JAMA*, 2002 Apr; 287(14): 1840-1847.



DEPARTMENT OF HEALTH &amp; HUMAN SERVICES

Public Health Service

Food and Drug Administration  
9200 Corporate Boulevard  
Rockville MD 20850Director and Senior Counsel, Regulatory Affairs  
Cyberonics, Inc.  
100 Cyberonics Boulevard  
Houston Texas 77058

AUG 11 2004

Re: P970003/S050  
VNS Therapy System  
Filed: October 27, 2003  
Amended: December 4 and 19, 2003, February 17, 2004, March 18  
and 29, 2004, April 5 and 8, 2004, July 7 and 8, 2004

Dear

The Center for Devices and Radiological Health (CDRH) of the Food and Drug Administration (FDA) has completed its review of your premarket approval application (PMA) supplement. The Neurological Devices Panel, which also reviewed your PMA supplement, recommended to CDRH at the June 15, 2004 panel meeting that the PMA supplement be considered approvable. However, we regret to inform you that, notwithstanding their recommendation, the PMA supplement, absent additional information, must be considered not approvable. Based on the requirements of 21 CFR 814.44(d), FDA, where practical, must identify measures necessary to make the PMA supplement approvable. Accordingly, to place your PMA supplement in approvable form, you must amend it to include the following:

**Safety**

There are safety concerns associated with the use of your device, including known risks related to implantation or stimulation, including serious adverse events such as asystole/bradycardia and vocal cord paralysis. In addition to known safety concerns, worsening depression was reported as a serious adverse event during the long-term D02 study. Without comparison to a control population, we are unable to determine whether your device places patients at increased risk for this event. As a result, we believe you have not provided a reasonable assurance that the probable benefits to health from use of the device for its intended uses and conditions outweigh the risks associated with its use.

Page 2 -

Effectiveness

A chief limitation of the long-term pivotal D02 clinical study, observational control D04 study comparative analysis was that the data were not derived from a randomized subject data set, but rather a comparison of outcomes from an investigational device study and observational control study. As a result, our ability to make meaningful conclusions from the data you provided was affected by the following limitations:

- a. Failure of the randomized, controlled pivotal D02 acute study to reach its primary efficacy endpoint.
- b. Potential bias of a non-randomized data set in the long-term D02, D04 comparative analysis that could reasonably affect the clinical outcomes reported in your study.
- c. Potential bias of unmeasured patient variables in the long-term D02, D04 comparative analysis that could reasonably affect the clinical outcomes reported in your study.
- d. Potential bias of unmasked ratings in the long-term D02, D04 comparative analysis that could reasonably affect the clinical outcomes reported in your study.
- e. Potential bias of research centers having more interest in the treatment study (the pivotal D02 study) rather than the naturalistic, observational control study (the D04 control study) that could reasonably affect the clinical outcomes reported in your study.
- f. Potential bias of patient expectation of participating in an investigational study for a new therapy versus the expectation of participating in an observational, control study that could reasonably affect the clinical outcomes reported in your study.
- g. Inability to distinguish the improvement attributable to VNS therapy from the improvement attributable to a placebo response in the long-term D02, D04 comparative analysis.
- h. Inability to distinguish the improvement attributable to VNS therapy from the improvement attributable to concomitant antidepressant treatments in the long-term D02, D04 comparative analysis.

Because of all of the issues identified above, we do not believe the submitted clinical data are sufficient to demonstrate safety and effectiveness of your device. You should therefore provide clinical data from a new, scientifically sound, randomized, controlled study, which addresses concomitant treatment use and includes adequate safety assessments in both the treatment and control group. We also suggest you contact us to discuss the contents of an appropriate clinical protocol design prior to collecting clinical data.

Page 3 -

The deficiencies identified above represent the issues that we believe need to be resolved before our review of your PMA application can be completed. In developing the deficiencies, we carefully considered the statutory criteria as defined in Section 515 of the Federal Food, Drug, and Cosmetic Act for determining reasonable assurance of safety and effectiveness of your device. We also considered the burden that may be incurred in your attempt to respond to the deficiencies. We believe that we have considered the least burdensome approach to resolving these issues. If, however, you believe that information is being requested that is not relevant to the regulatory decision or that there is a less burdensome way to resolve the issues, you should follow the procedures outlined in the "A Suggested Approach to Resolving Least Burdensome Issues" document. It is available on our Center webpage at: <http://www.fda.gov/cdrh/modact/leastburdensome.html>

This is to advise you that an amendment including the above requested information will be considered a major amendment and may extend the FDA review period up to 180 days. As provided by 21 CFR 814.37(c) you may decline to submit a major amendment requested by FDA in which case the review period may be extended for the number of days that elapse between the date of such request and the date that FDA receives the written response declining to submit the requested amendment.

As provided by 21 CFR 814.44(f), you may amend your PMA supplement as requested above, withdraw the PMA supplement, or consider this letter to be a denial of approval of the PMA supplement under 21 CFR 814.45 and request administrative review. Any request for administrative review, either through a hearing or review by an independent advisory committee, under section 515(d)(4) and 515(g) of the Federal Food, Drug, and Cosmetic Act, must be submitted in the form of a petition for reconsideration under 21 CFR 10.33 and in accordance with the general administrative procedures under 21 CFR 10.20. Any petition for reconsideration must be submitted to the Food and Drug Administration, Dockets Management Branch (HFA-305), Room 1-23, 12420 Parklawn Drive, Rockville, Maryland 20857, within 30 days of your receipt of this letter. After reviewing the petition, FDA will decide whether to grant or deny the petition and will publish a notice of its decision in the FEDERAL REGISTER. If FDA grants the petition, the notice will state the issues to be reviewed, the form of the review to be used, the person may participate in the review, the time and place where the review will occur, and other details.

As provided under 21 CFR 814.44(g), FDA will consider this PMA supplement to have been voluntarily withdrawn if you fail to respond in writing within 180 days of the date of this request for a PMA supplement amendment. You may, however, amend the PMA supplement within the 180-day period to request an extension of time to respond. Any such request is subject to FDA approval and should justify the need for the extension and provide a reasonable estimate of when the requested information will be submitted. If you do not amend the PMA supplement within the 180-day period to (1) correct the above deficiencies, or (2) request an extension of time to respond and have the request approved, any amendment submitted after the 180-day period will

Page 4 -

be considered a resubmission of the PMA supplement and will be assigned a new number. Under these circumstances, any resubmission will be given a new PMA supplement number and will be subject to the requirements of 21 CFR 814.20.

You may amend the PMA supplement to provide the above requested information, voluntarily withdraw the PMA supplement (3 copies), direct CDRH to complete processing the PMA supplement without the submission of additional information (3 copies), or request an extension.

The required copies of the amended PMA supplement should include the FDA reference number to facilitate processing for this PMA supplement and should be submitted to the following address:

PMA Document Mail Center (HFZ-401)  
Center for Devices and Radiological Health  
Food and Drug Administration  
9200 Corporate Boulevard  
Rockville, Maryland 20850

If you have any questions concerning this not-approvable letter, please contact at

Sincerely yours,

Acting Director  
Office of Device Evaluation  
Center for Devices and  
Radiological Health

## Original Redactions by FDA



DEPARTMENT OF HEALTH &amp; HUMAN SERVICES

 95129d  
 Food and Drug Administration

 Dallas District  
 4040 North Central Expressway  
 Dallas, Texas 75204-3145

December 22, 2004

Ref: 2005-DAL-WL-7

**WARNING LETTER****CERTIFIED MAIL  
RETURNED RECEIPT REQUESTED**

Mr. Robert (Skip) P. Cummins, President and CEO  
 Cyberonics, Inc.  
 100 Cyberonics Blvd.  
 Houston, Texas 77058 - 2017

Dear Mr. Cummins:

During an inspection of your firm's manufacturing operations located in Houston, Texas, on July 12 through September 15, 2004, United States Food and Drug Administration (FDA) Investigator, Ellen J. Tave, determined that your firm manufactures the Vagus Nerve Stimulator (VNS), an implanted generator that is indicated for use as an adjunctive therapy in reducing the frequency of seizures in adults and adolescents over 12 years of age with medically intractable partial seizures. The VNS system includes a pulse generator, programming wand, programming software, electrode leads, tunnelling tool, and accessory pack. This product is a device as defined in Section 201(h) of the Federal Food, Drug, and Cosmetic Act (the Act).

The above-stated inspection revealed that these devices are adulterated within the meaning of Section 501(h) of the Act, in that the methods used in, or the facilities or controls used for their manufacturing, packing, storage, or installation are not in conformance with the Current Good Manufacturing Practice (CGMP) requirements of the Quality System (QS) Regulation for medical devices, as specified in Title 21, Code of Federal Regulation (CFR), Part 820.

**Quality System Regulation**

At the close of the inspection, your firm was issued a list of inspectional observations, Form FDA-483 (copy enclosed), which identified a number of significant QS regulation violations including, but not limited to, the following:

Page 2 - Mr. Robert (Skip) P. Cummins  
President and CEO  
Cyberonics, Inc.  
December 22, 2004

- 1 Failure to completely investigate and evaluate the cause of each medical adverse event as required by 21 CFR 803.50(b)(2) and failure to maintain complete deliberation results as required by 21 CFR 803.18(b)(1)(i) [FDA-483, Item 1]. For example, your firm has not provided adequate documentation of deliberations to support your firm's decision making process for explaining why your firm could not reach a conclusion about the cause of (a) device migration reported in complaint file # 200306-0477 (reference MDR report # 2003-00402); and (b) high lead impedance, device migration, increase in seizures, and subsequent patient death reported in complaint file # 200312-0567 (reference MDR report # 2004-00030).
2. Failure to establish and maintain adequate procedures for validating the device design to ensure that the device conforms to user needs and intended uses and include design testing under actual or simulated use conditions as required by 21 CFR 820.30(g) [FDA 483, Item 2]. Evidence of your firm's design validation with regard to Model 102 is inadequate. For example:
  - a) Evidence of design validation lacked supporting documentation to demonstrate how your simulated testing of the generator and the lead connecting to a [REDACTED] load actually simulated use conditions. For example, in an [REDACTED] chamber [REDACTED] maintained at [REDACTED] [REDACTED] evidence was not provided which demonstrated the equivalence to the actual implanted generator and electrode connecting to the vagus nerve which resides in a fluidal or wet condition in the chest cavity (actual implant environment); and
  - b) There was a lack of supporting documentation explaining why real time testing is not needed to verify the actual device longevity and a lack of evidence confirming the accuracy of your theoretical device life expectancy across patient programming ranges at the end of service voltage (actual use condition).
  - c) The design validation does not appear to address the impact of possible increase in lead impedance of the electrode and vagus nerve interface during the course of patient therapy on battery life. Therefore, the accuracy of your theoretical estimate of device longevity is called into question; and
  - d) The theoretical calculation of battery hours of operation does not appear to include or discuss the effect of the total number of patient magnet wipes (activations) on actual device longevity at nominal conditions in clinical settings (actual use condition); and



Page 3 - Mr. Robert (Skip) P. Cummins  
President and CEO  
Cyberonics, Inc.  
December 22, 2004

- e) The design validation does not discuss or reference testing results of the ERI (Elective Replacement Indicator) flag under the various fault diagnostics conditions listed in the Physician's Manual (Section High Lead Impedance on a Diagnostic Test at Follow-up Visit).
3. Failure to investigate the cause of nonconformities relating to product, processes, and the quality system as required by 21 CFR 820.100(a)(2) [FDA-483, Items 3, 9, and 10]. For example:
- a) Complaints of suspected end of service (EOS) were not considered as a product complaint, and there were no attempts to collect patient's programming data to evaluate if the devices reached normal/expected EOS; and
  - b) Your firm has not documented the death data by age categories to support data analysis required in CAPA Investigation Report INV 01-0006, dated January 8, 2002 and February 19, 2003. Your firm then concluded that there was no relationship seen in seizure changes among the 81 patients but reported that the patients responses to the VNS therapy were unknown or there was no information for 28 of 81 patients. Your firm also had not collected programming history data to assess the relationship of the amount of stimulation therapy at the time of death; and
  - c) CAPA investigation to verify a physician's observations that the devices delivered less current therapy than what were programmed during the last 6 to 12 months of device life had incomplete explanation of the results of Phase II and III testing; and
  - d) Product analysis (PA) of explanted generators did not show testing of the devices using the patients programming history to confirm or duplicate the patient complaints or non-complaints. For example, PA #5243, 4935, and 5600; and
  - e) Incident # 200310-1077 reported that a pediatric patient was implanted on December 18, 2002 and explanted on October 8, 2003 due to suspected end of service (EOS). The generator was implanted for almost 10 months. Your firm has not explained why the implanted generator did not set the ERI flag as it was approaching EOS. The user reported that the ERI flag did not set in spite of a high lead impedance reading. Your firm did not conduct duplicate testing of the explanted generator using the user's actual programming parameters to confirm the user's complaint of EOS. Your firm's product analysis documented that the explanted generator met its electrical specifications but did not explain (a) how your firm's electrical

Page 4 - Mr. Robert (Skip) P. Cummins  
President and CEO  
Cyberonics, Inc.  
December 22, 2004

testing results are related to the user's complaint, and (b) your firm's evaluation of the user report of normal diagnostics test results of high lead impedance in your product analysis report.

4. Failure to analyze processes, work operations, and other sources of quality data to identify existing and potential causes of non-conforming product as required by 21 CFR 820.100(a)(1) [FDA-483, Item 4, 6, and 11]. For example:
  - a) Your firm has not documented, analyzed, and evaluated the reasons for both implants/reimplants and product returns to identify existing and potential causes of non-conforming product. Your firm does not know or explain how many reimplants were due to broken leads, suspected end of service (EOS), actual EOS, and high lead impedance; and
  - b) User reports (non-complaints) of suspected EOS and confirmed EOS, and collected data on adverse events of asystole and bradycardia were omitted from [REDACTED] CAPA meetings; and
  - c) Your firm has not analyzed complaints of high lead impedance, lead discontinuity, confirmed EOS, and suspected EOS to identify how many complaints were confirmed with an ERI (Elective Replacement Indicator) flag being set; and
  - d) Your firm has not described the possible meaning of complaint conclusion code 40 in order to explain how complaints or adverse events were resolved with this conclusion code. It was found that conclusion code 40 was often used when the adverse events were resolved by device explants and reimplants. Review of complaint data queried by conclusion code 40 showed that your firm had classified 1081 complaints and 524 MDR reports using this code; and
  - e) Your firm has neither collected nor analyzed patient programming history since 1997 in order to provide a theoretical estimate of actual device longevity over the entire implant population.
5. Failure to implement and record changes in methods and procedures needed to prevent and correct identified quality problems as required by 21 CFR 820.100(a)(5) [FDA-483, Item 8]. For example, although your firm has listed several potential causes of high lead impedance, your firm has not implemented the necessary solutions and verified their effectiveness in order to address numerous complaints of high lead impedance. A complaint log entitled "Lead Discontinuity, Suspected Lead Discontinuity, or High Lead

Page 5 - Mr. Robert (Skip) P. Cummins  
President and CEO  
Cyberonics, Inc.  
December 22, 2004

Impedance Incoming Complaints with Conclusions" for the period of January 1, 2002 through May 31, 2004 documented that 89 complaints were identified as a "design" issue.

6. Failure to establish and maintain procedures for implementing corrective and preventive action as required by 21 CFR 820.100(a) (FDA-483 Items 7 and 11). For example, your firm (a) has not documented, analyzed, and evaluated the reasons for thousands of reimplants since 1997; (b) has not analyzed patient programming history data over the entire implant population; and (c) does not know how many reimplants were due to broken leads, suspected EOS, confirmed EOS, and high lead impedance, in order to validate input data used to calculate your firm's cumulative survival probability for the implanted generators. In addition, your firm has not explained how your device's survival probability curve matches the actual device longevity in clinical settings.
7. Failure to establish and maintain procedures for receiving, reviewing, and evaluating complaints by a formally designated unit as required by 21 CFR 820.198(a). For example, your firm has not defined how your firm differentiates user complaints of suspected EOS from complaints of confirmed EOS, or high lead impedance.

#### Cyberonics' Response

We acknowledge receiving your letters with attachments, dated September 17, October 7, and December 8, 2004, responding to the Form FDA-483, Inspectional Observations, issued to your firm at the conclusion of our inspection on September 15, 2004. We have completed our review and determined that your response is incomplete. Your December 8<sup>th</sup> response was incomplete and did not provide any supporting information or evidence relating to the longevity verification. Your responses have not satisfactorily addressed the underlying issues. For example:

- 1 Your response did not clearly explain whether or not your firm considers user reports of suspected end of service (EOS) as a product complaint to be treated in accordance with 21 CFR 820.198(a). Your firm has not been able to determine the causes associated with many user reports of suspected EOS or high lead impedance or that your firm has not determined and documented how many reimplants were due to normal/actual EOS, suspected EOS, or high lead impedance. See your firm's investigation reports INV 02-0014, 02-0024, and 03-0016. Your firm also has not (a) explained whether your firm will attempt to collect patient programming history to aid your firm's investigation of complaints of suspected EOS or high lead impedance; and (b)

Page 6 - Mr. Robert (Skip) P. Cummins  
President and CEO  
Cyberonics, Inc.  
December 22, 2004

established procedures to indicate how your firm differentiates user complaints of suspected EOS from user complaints of actual EOS or high lead impedance to determine if in fact the devices were approaching or at their normal end of service based on the actual patient programming parameters. Your firm's investigation report 02-0014 was initiated in October, 2002 which recommended corrective actions to address user reports of high lead impedance. However, the completion dates for the proposed corrective actions were still classified "TBD" (To be Determined) at the time of the inspection.

- 2 Your firm has not been able to determine or explain how many reimplant cases were due to high lead impedance or other potential quality problems. Although your firm has identified several theoretical causes of high lead impedance complaints (user training, lead manufacturing defects, and design robustness), your firm has not completed the following proposed corrective actions. The effectiveness of these proposed corrective actions cannot be determined until you provide the results of your firm's monitoring of the high lead impedance complaints.
  - (a) Corrective Action Plan CAR 03-0003 addressing user training a potential cause of high lead impedance are in process without establishing an expected completion date; and
  - (b) Your response reported that Corrective Action Plan CAR 03-0004 addresses the handling of the Model 300 and Model 302 leads during manufacturing as a potential cause of high lead impedance was completed on July 16, 2004 during our inspection. You indicated manufacturing defects related to coil damage was not a significant cause of high lead impedance events. However, you have not explained what types of lead defects you found, specific steps your firm has taken or will take (a) to reduce incidents of lead manufacturing defects; (b) establish complaint investigation methods to differentiate user complaints of high lead impedance caused by a lack of user training from user complaints of high lead impedance caused by manufacturing lead defects; and
  - (c) [REDACTED] design project (DHF 0044) was initiated in [REDACTED] and is not expected to be completed until [REDACTED]
3. Your response implied that FDA's approval of your original PMA or subsequent PMA supplements means that FDA approves your firm's design controls. This is not true. Your firm's design control steps must be continuously maintained throughout the device design life cycle to ensure compliance with 21 CFR 820.30. Your response further stated that the

Page 7 - Mr. Robert (Skip) P. Cummins  
 President and CEO  
 Cyberonics, Inc.  
 December 22, 2004

investigator attempted to inspect the safety and effectiveness of your devices. We disagree. The investigator explained that she did not inspect the safety and effectiveness of your devices epilepsy indication but rather she questioned the adequacy of your firm's design validation process concerning simulated testing of actual device implant conditions and device longevity.

4. Regarding simulated testing of actual implant environment, as part of your device failure investigation process, some of the explanted generators were actually tested in a [REDACTED] solution in order to investigate the complaint issues of suspected end of service, high lead impedance, or generators not delivering enough therapeutic currents as programmed. See your investigation reports INV 03-0016 and 02-0024. These two investigation reports documented that the explanted devices were placed in a [REDACTED] solution to simulate the actual implant environment. Your firm failed to explain how this type of testing is appropriately related to the original design validation testing of Model 100 in 1997, 101, and 102 in 2002.
5. Regarding real time testing to confirm device longevity, your response explained that performing the real time testing is inappropriate because it would require [REDACTED] to complete, and your mathematical equation for device longevity was based on "proven laws of math." First, your response has not explained why it takes [REDACTED] to conduct real time testing across all programming parameters. Second, you have not explained if your firm has (a) trended and/or documented the actual implant times of the clinical patients enrolled in the prior E01 – E05 studies using Model 100, the patients enrolled in the current Depression clinical study, or current non-clinical patients implanted with model 101 and 102, in order to compare their projected (theoretical) implant times to their actual implant times. Third, in your firm's Table 20 [Nominal Longevity Estimates Begin of Life (BOL) to End of Service (EOS)] listed in the electrical characterization report, your firm's longevity equation calculated that the device longevity would last [REDACTED] at a heavy stimulation setting of [REDACTED] and [REDACTED] % duty cycle. Real time testing at this rapid simulation setting would take about [REDACTED] not [REDACTED] to verify the accuracy of your theoretical device longevity equation.
6. Magnet Activations by Patients, you responded that the occurrence of manual magnet activations by patients would not cause any significant reduction of device longevity when compared to normal device stimulation. However, you acknowledged that your firm's extrapolation of energy consumption and rationales were not explained and documented in the design validation documents, e.g., electrical characterization report.

Page 8 - Mr. Robert (Skip) P. Cummins  
President and CEO  
Cyberonics, Inc.  
December 22, 2004

7. Your firm's current complaint handling procedure requires that a reply letter be sent to the complainant (physician) if your firm's complaint investigation resulted in "user error", and the user has not been notified of the error. The use of the VNS device for pediatric patients younger than 12 years of age is an unapproved use (off-label use), and therefore, adverse events related to this use are considered user error. See 21 CFR 803.3(d). In this situation, your firm did not follow its complaint handling procedures in that your firm had not sent reply letters to the complainants to notify them of user error concerning medical adverse events occurring in pediatric patients younger than 12 years of age. Our inspection documented that your firm had received 197 serious injury reports, 53 death reports, and 99 malfunction reports that were coded 212 (unapproved use of device) from January 1, 2002 through May, 14, 2004. Many of these medical adverse events were associated with the users using the VNS devices in pediatric patients younger than 12 years of age. We believe your firm should send a reply to each complainant in order to prevent further misuse, injury or other adverse situations from recurring. When the problem was caused by misuse, it is very important to advise the user to help prevent further misuse. If your firm believes there may be cases where a reply is not necessary, the record should state that no reply was made and the reason for not replying. Finally, although not sending a reply letter to the complainant is not a deviation of 21 CFR 820.198(e)(8), when a reply is sent it must be kept as part of the complaint file.

In summary of our review, your firm should implement a comprehensive QS action plan and provide FDA with status update reports outlining specific steps addressing the specific FDA-483 observations and issues identified in this letter and a global approach to correct and prevent any potential systemic problems.

#### Responding to This Letter

This letter is not intended to be an all-inclusive list of deficiencies at your facility. It is your responsibility to ensure adherence to each requirement of the Act and the regulations. The specific violations noted in this letter and in the Form FDA-483 issued at the close of the inspection may be symptomatic of serious underlying problems in your firm's manufacturing and quality assurance systems. Federal agencies are advised of the issuance of all Warning Letters about devices so that they may take this information into account when considering the award of contracts.

You should take prompt action to correct these violations. Failure to promptly correct these violations may result in regulatory action being initiated by the Food and Drug Administration without further notice. These actions include, but are not limited to, seizure, injunction, and/or civil penalties.

Page 9 - Mr. Robert (Skip) P. Cummins  
President and CEO  
Cyberonics, Inc.  
December 22, 2004

Please notify this office in writing within 15 working days of receipt of this letter of the specific steps you have taken, or will take to identify and correct the noted violations, including (1) the time frames within which the corrections will be completed, (2) any documentation indicating the corrections have been achieved, and (3) an explanation of each step being taken to identify and make corrections to any underlying systems problems necessary to ensure that similar violations will not recur. It is recommended that after responding to this letter that you have a meeting concurrently with both Dallas District Office and the Center for Devices and Radiological Health in order to facilitate appropriate technical discussion surrounding this letter and the inspection.

Your reply should be directed to Thao Ta, Compliance Officer, at the address indicated on the above letterhead.

Sincerely,



Michael A. Chappell  
Dallas District Director

MAC:bt



DEPARTMENT OF HEALTH &amp; HUMAN SERVICES

Public Health Service

FEB - 2 2005

Food and Drug Administration  
9200 Corporate Boulevard  
Rockville MD 20850

Director and Senior Counsel, Regulatory Affairs  
Cyberonics, Inc.  
100 Cyberonics Boulevard  
Houston, TX 77058

Re: P970003/S50  
VNS Therapy System  
Filed: October 27, 2003  
Amended: December 4 and 19, 2003; February 17, March 18 and 29, April 5 and 8,  
July 7 and 8, and September 8 and 23, 2004.

Dear

The Center for Devices and Radiological Health (CDRH) of the Food and Drug Administration (FDA) has completed its review of your premarket approval application (PMA) supplement. CDRH is pleased to inform you that the PMA supplement is approvable. Be advised that CDRH is continuing to review your labeling and will communicate any remaining changes via phone and fax. In addition, please submit the following:

- 1) Complete postapproval study protocols must be provided to further characterize the optimal stimulation dosing and patient selection criteria for the VNS Therapy System for the treatment of chronic or recurrent depression in patients with treatment resistant depression (TRD). CDRH will continue to work interactively with you to develop the appropriate investigational plans. A final version must be submitted as an amendment to your PMA.
- 2) Revised physician and patient labeling must be provided to address our remaining concerns and comments. CDRH will continue to work interactively with you to develop the appropriate labeling. A final draft version must be submitted as an amendment to your PMA.
- 3) Satisfactory responses to all outstanding bioresearch monitoring issues must be provided to address the deficiencies discovered during FDA inspections of your investigational sites.

Please be advised that the PMA supplement cannot be approved until FDA has determined that the manufacturing facilities, methods and controls comply with the conditions set forth in your application and the applicable requirements of the Quality



Page 2 –

System Regulation (21 CFR Part 820). If you have any questions regarding the status of your Quality System inspection please contact the Office of Compliance at (240) 276-0131, or your District Office.

The PMA supplement must be amended to include your concurrence with, or suggested revision of, the enclosed Conditions of Approval. In addition, you must agree to conduct two post-approval studies, as indicated in deficiency number 1 above, to further characterize the optimal stimulation dosing and patient selection criteria for the VNS Therapy System for TRD. The first study will be a prospective, multicenter, randomized, double-blind comparison of different output currents in 450 new subjects with TRD. You have agreed to assess the effectiveness responses to differing outputs 16 weeks after the end of a 4-6 week titration period during which concomitant therapies will not be changed. You have also agreed to follow these subjects for at least one year following implantation to further characterize duration of response as well as safety parameters at these higher doses. The second study will be a prospective, observation registry study of 1000 implanted subjects with TRD with follow-up extending to 5 years after implantation. This study will be designed to evaluate long-term patient outcomes as well as predictors of response to therapy. Post approval study progress reports and results will be submitted as a report to the PMA at 6 month intervals. As appropriate, CDRH may request panel review of the postapproval study data. When necessary, the results will be incorporated into the labeling, via a supplement.

The deficiencies identified above represent the issues that we believe need to be resolved before our review of your PMA application can be completed. In developing the deficiencies, we carefully considered the statutory criteria as defined in Section 515 of the Federal Food, Drug, and Cosmetic Act for determining reasonable assurance of safety and effectiveness of your device. We also considered the burden that may be incurred in your attempt to respond to the deficiencies. We believe that we have considered the least burdensome approach to resolving these issues. If, however, you believe that information is being requested that is not relevant to the regulatory decision or that there is a less burdensome way to resolve the issues, you should follow the procedures outlined in the "A Suggested Approach to Resolving Least Burdensome Issues" document. It is available on our Center webpage at:

<http://www.fda.gov/cdrh/modact/leastburdensome.html>

The sale, distribution, and use of this device are restricted to prescription use in accordance with 21 CFR 801.109 within the meaning of section 520(e) of the Federal Food, Drug, and Cosmetic Act (the act) under the authority of section 515(d)(1)(B)(ii) of the act. FDA has also determined that, to ensure the safe and effective use of the device, the device is further restricted within the meaning of section 520(e) under the authority of section 515(d)(1)(B)(ii), (1) insofar as the labeling specify the requirements that apply to the training of practitioners who may use the device and (2) insofar as the sale, distribution, and use must not violate sections 502(q) and (r) of the act.

Page 3 –

Following receipt of an approvable letter, an applicant is required by 21 CFR 814.20(e) to update its pending PMA supplement with new safety and effectiveness information pertinent to the requested change or modification and learned about the device from ongoing or completed studies that may reasonably affect an evaluation of the safety or effectiveness of the device or that may reasonably affect the statement of contraindications, warnings, precautions and adverse reactions in the draft labeling. This updated reporting is limited to studies sponsored by the applicant or to which the applicant has reasonable access. The clinical update must be consistent with the data reporting provisions of the protocol.

CDRH will issue an approval order after the requested information has been reviewed and determined to be acceptable. You may not begin commercial distribution of the device as modified by this PMA supplement until you have received an approval order and final printed labeling has been submitted to FDA.

You may amend your PMA supplement as requested or withdraw it, or you may treat this letter as a formal denial of approval. If you choose the latter, you may request administrative review, either through a hearing or review by an independent advisory committee, under section 515(d)(4) and 515(g) of the Federal Food, Drug, and Cosmetic Act by filing a petition with the Food and Drug Administration, Dockets Management Branch (HFA-305), Room 1-23, 12420 Parklawn Drive, Rockville, Maryland 20857, within 30 days of the date you receive this letter. A petition for administrative review must be submitted in accordance with general administrative procedures for submission of documents to the Dockets Management Branch (21 CFR 10.20) and in the form of a petition for reconsideration (21 CFR 10.33). After reviewing the petition, FDA will decide whether to grant or deny the petition and will publish a notice of its decision in the FEDERAL REGISTER. If FDA grants the petition, the notice will state the issues to be reviewed, the form of the review to be used, the persons who may participate in the review, the time and place where the review will occur, and other details.

As provided under 21 CFR 814.44(g), FDA will consider this PMA to have been voluntarily withdrawn if you fail to respond in writing within 180 days of the date of this request for a PMA amendment. You may, however, amend the PMA within the 180-day period to request an extension of time to respond. Any such request is subject to FDA approval and should justify the need for the extension and provide a reasonable estimate of when the requested information will be submitted. If you do not amend the PMA within the 180-day period to (1) correct the above deficiency(ies), or (2) request an extension of time to respond and have the request approved, any amendment submitted after the 180-day period will be considered a resubmission of the PMA and will be assigned a new number. Under these circumstances, any resubmission will be given a new PMA number and will be subject to the requirements of 21 CFR 814.20.

You may amend the PMA to provide the above requested information (3 copies), clinical data update (3 copies), voluntarily withdraw the PMA (3 copies), direct CDRH to complete processing the PMA without the submission of additional information (3

Page 4 –

copies), or request an extension. The required copies of the amended PMA supplement should include the FDA reference number to facilitate processing for this PMA and should be submitted to the following address:

PMA Document Mail Center (HFZ-401)  
Center for Devices and Radiological Health  
Food and Drug Administration  
9200 Corporate Blvd.  
Rockville, Maryland 20850

If you have any questions concerning this approvable letter, please contact me at

Sincerely yours,

Director  
Center for Devices and  
Radiological Health  
Food and Drug Administration

Enclosure

Last Modified: 1-31-02

## CONDITIONS OF APPROVAL

**PREMARKET APPROVAL APPLICATION (PMA) SUPPLEMENT**. Before making any change affecting the safety or effectiveness of the device, submit a PMA supplement for review and approval by FDA unless the change is of a type for which a "Special PMA Supplement-Changes Being Effected" is permitted under 21 CFR 814.39(d) or an alternate submission is permitted in accordance with 21 CFR 814.39(e) or (f). A PMA supplement or alternate submission shall comply with applicable requirements under 21 CFR 814.39 of the final rule for Premarket Approval of Medical Devices.

All situations that require a PMA supplement cannot be briefly summarized; therefore, please consult the PMA regulation for further guidance. The guidance provided below is only for several key instances.

A PMA supplement must be submitted when unanticipated adverse effects, increases in the incidence of anticipated adverse effects, or device failures necessitate a labeling, manufacturing, or device modification.

A PMA supplement must be submitted if the device is to be modified and the modified device should be subjected to animal or laboratory or clinical testing designed to determine if the modified device remains safe and effective.

A "Special PMA Supplement - Changes Being Effected" is limited to the labeling, quality control and manufacturing process changes specified under 21 CFR 814.39(d)(2). It allows for the addition of, but not the replacement of previously approved, quality control specifications and test methods. These changes may be implemented before FDA approval upon acknowledgment by FDA that the submission is being processed as a "Special PMA Supplement - Changes Being Effected." This procedure is not applicable to changes in device design, composition, specifications, circuitry, software or energy source.

Alternate submissions permitted under 21 CFR 814.39(e) apply to changes that otherwise require approval of a PMA supplement before implementation of the change and include the use of a 30-day PMA supplement or annual postapproval report (see below). FDA must have previously indicated in an advisory opinion to the affected industry or in correspondence with the applicant that the alternate submission is permitted for the change. Before such can occur, FDA and the PMA applicant(s) involved must agree upon any needed testing protocol, test results, reporting format, information to be reported, and the alternate submission to be used.

Alternate submissions permitted under 21 CFR 814.39(f) for manufacturing process changes include the use of a 30-day Notice. The manufacturer may distribute the device 30 days after the date on which the FDA receives the 30-day Notice, unless the FDA notifies the applicant within 30 days from receipt of the notice that the notice is not adequate.

**POSTAPPROVAL REPORTS.** Continued approval of this PMA is contingent upon the submission of postapproval reports required under 21 CFR 814.84 at intervals of 1 year from the date of approval of the original PMA. Postapproval reports for supplements approved under the original PMA, if applicable, are to be included in the next and subsequent annual reports for the original PMA unless specified otherwise in the approval order for the PMA supplement. Two copies identified as "Annual Report" and bearing the applicable PMA reference number are to be submitted to the PMA Document Mail Center (HFZ-401), Center for Devices and Radiological Health, Food and Drug Administration, 9200 Corporate Blvd., Rockville, Maryland 20850. The postapproval report shall indicate the beginning and ending date of the period covered by the report and shall include the following information required by 21 CFR 814.84:

1. Identification of changes described in 21 CFR 814.39(a) and changes required to be reported to FDA under 21 CFR 814.39(b).
2. Bibliography and summary of the following information not previously submitted as part of the PMA and that is known to or reasonably should be known to the applicant:
  - a. unpublished reports of data from any clinical investigations or nonclinical laboratory studies involving the device or related devices ("related" devices include devices which are the same or substantially similar to the applicant's device); and
  - b. reports in the scientific literature concerning the device.

If, after reviewing the bibliography and summary, FDA concludes that agency review of one or more of the above reports is required, the applicant shall submit two copies of each identified report when so notified by FDA.

**ADVERSE REACTION AND DEVICE DEFECT REPORTING.** As provided by 21 CFR 814.82(a)(9), FDA has determined that in order to provide continued reasonable assurance of the safety and effectiveness of the device, the applicant shall submit 3 copies of a written report identified, as applicable, as an "Adverse Reaction Report" or "Device Defect Report" to the PMA Document Mail Center (HFZ-401), Center for Devices and Radiological Health, Food and Drug Administration, 9200 Corporate Blvd., Rockville, Maryland 20850 within 10 days after the applicant receives or has knowledge of information concerning:

1. A mix-up of the device or its labeling with another article.
2. Any adverse reaction, side effect, injury, toxicity, or sensitivity reaction that is attributable to the device and:
  - a. has not been addressed by the device's labeling; or
  - b. has been addressed by the device's labeling but is occurring with unexpected severity or frequency.

3. Any significant chemical, physical or other change or deterioration in the device, or any failure of the device to meet the specifications established in the approved PMA that could not cause or contribute to death or serious injury but are not correctable by adjustments or other maintenance procedures described in the approved labeling. The report shall include a discussion of the applicant's assessment of the change, deterioration or failure and any proposed or implemented corrective action by the applicant. When such events are correctable by adjustments or other maintenance procedures described in the approved labeling, all such events known to the applicant shall be included in the Annual Report described under "Postapproval Reports" above unless specified otherwise in the conditions of approval to this PMA. This postapproval report shall appropriately categorize these events and include the number of reported and otherwise known instances of each category during the reporting period. Additional information regarding the events discussed above shall be submitted by the applicant when determined by FDA to be necessary to provide continued reasonable assurance of the safety and effectiveness of the device for its intended use.

**REPORTING UNDER THE MEDICAL DEVICE REPORTING (MDR) REGULATION.**

The Medical Device Reporting (MDR) Regulation became effective on December 13, 1984. This regulation was replaced by the reporting requirements of the Safe Medical Devices Act of 1990 which became effective July 31, 1996 and requires that all manufacturers and importers of medical devices, including in vitro diagnostic devices, report to the FDA whenever they receive or otherwise become aware of information, from any source, that reasonably suggests that a device marketed by the manufacturer or importer:

1. May have caused or contributed to a death or serious injury; or
2. Has malfunctioned and such device or similar device marketed by the manufacturer or importer would be likely to cause or contribute to a death or serious injury if the malfunction were to recur.

The same events subject to reporting under the MDR Regulation may also be subject to the above "Adverse Reaction and Device Defect Reporting" requirements in the "Conditions of Approval" for this PMA. FDA has determined that such duplicative reporting is unnecessary. Whenever an event involving a device is subject to reporting under both the MDR Regulation and the "Conditions of Approval" for a PMA, the manufacturer shall submit the appropriate reports required by the MDR Regulation within the time frames as identified in 21 CFR 803.10(c) using FDA Form 3500A, i.e., 30 days after becoming aware of a reportable death, serious injury, or malfunction as described in 21 CFR 803.50 and 21 CFR 803.52 and 5 days after becoming aware that a reportable MDR event requires remedial action to prevent an unreasonable risk of substantial harm to the public health. The manufacturer is responsible for submitting a baseline report on FDA Form 3417 for a device when the device model is first reported under 21 CFR 803.50. This baseline report is to include the PMA reference number. Any written report and its envelope is to be specifically identified, e.g., "Manufacturer Report," "5-Day Report," "Baseline Report," etc.

Any written report is to be submitted to:

Food and Drug Administration  
Center for Devices and Radiological Health  
Medical Device Reporting  
PO Box 3002  
Rockville, Maryland 20847-3002

Copies of the MDR Regulation (FOD # 336&1336) and FDA publications entitled "An Overview of the Medical Device Reporting Regulation" (FOD # 509) and "Medical Device Reporting for Manufacturers" (FOD #987) are available on the CDRH WWW Home Page. They are also available through CDRH's Fact-On-Demand (F-O-D) at 800-899-0381. Written requests for information can be made by sending a facsimile to CDRH's Division of Small Manufacturers International and Consumer Assistance (DSMICA) at 301-443-8818.



DEPARTMENT OF HEALTH &amp; HUMAN SERVICES

Public Health Service

Food and Drug Administration  
Rockville MD 20857

The Honorable Charles E. Grassley  
Chairman  
Committee on Finance  
United States Senate  
Washington, D.C. 20510-6200

JUL 20 2005

Dear Mr. Chairman:

This is in response to your letter of July 7, 2005, co-signed by Ranking Minority Member Max Baucus, regarding the Food and Drug Administration's (FDA or the Agency) review of Cyberonics, Inc.'s Panel Track Pre-market Approval (PMA) Supplement for the Vagus Nerve Stimulation (VNS) Therapy to address treatment-resistant depression (TRD) in adults. Specifically, you inquired whether there exists an agreement between Cyberonics and FDA, which provides that "...the FDA would approve VNS Therapy for the indications of TRD if Cyberonics would agree to voluntarily withdraw VNS Therapy for TRD if post-marketing studies failed to show efficacy."

We assure you that there exists no agreement or understanding between FDA and Cyberonics, written or oral, that FDA would approve VNS Therapy for TRD in exchange for Cyberonics' promise to voluntarily withdraw this device for this indication if post-marketing studies failed to show efficacy. Such an agreement or understanding between FDA and Cyberonics has never been discussed.

Cyberonics has, however, agreed to conduct post-approval studies to collect additional data on the long-term safety and effectiveness of VNS Therapy for TRD. Specifically, the firm plans to conduct a one-year dosing study of 450 patients, and a five-year patient registry, which will include a minimum of 2,000 patients--1,000 patients receiving VNS therapy and 1,000 patients not receiving it. These studies are the products of extensive discussion between FDA and Cyberonics concerning appropriate study design and the need to address issues related to the long-term use of VNS Therapy. At no time did FDA and Cyberonics discuss or reach an agreement or understanding by which Cyberonics would voluntarily withdraw the device if the studies failed to show effectiveness of the device.

Consideration of post-market controls is an important component of FDA's Pre-Market Approval program for devices. Indeed, Congress specifically directed the Agency to consider its post-market authorities in making pre-market determinations about the



Page 2 - The Honorable Charles E. Grassley

effectiveness of devices. The Food and Drug Administration Modernization Act of 1997 added section 513(a)(3)(C) to the Act, which provides:

“In making a determination of a reasonable assurance of the safety and effectiveness of a device for which [a PMA application] has been submitted, the Secretary shall consider whether the extent of data that otherwise would be required for approval of the application with respect to effectiveness can be reduced through reliance on postmarket controls.”

Consistent with this Congressional directive, FDA evaluated a number of considerations in making its decision to approve VNS for TRD, including Cyberonics’ strong post-market study plan. In doing so, the Agency was acting in accordance not only with its statutory authorities but also with long-standing Agency practice. The Agency has ordered post-approval studies of devices to address concerns about long-term safety and effectiveness since the inception of its PMA program.

In sum, the studies agreed to by Cyberonics do not reflect an inappropriate agreement by the Agency to permit the marketing of a device in exchange for a promise of withdrawal should the studies show the device to be ineffective. To the contrary, these studies are the product of a conscientious effort by the Agency to balance its responsibility to protect the public health by requiring a reasonable assurance of safety and effectiveness and to give due consideration to appropriate post-market controls for devices, as required by statute.

Sincerely,

  
Patrick Ronan  
Associate Commissioner  
for Legislation



DEPARTMENT OF HEALTH &amp; HUMAN SERVICES

Public Health Service

Food and Drug Administration  
Rockville MD 20857

The Honorable Charles E. Grassley  
Chairman  
Committee on Finance  
United States Senate  
Washington, D.C. 20510-6200

AUG 9 2005

Dear Mr. Chairman:

This is in response to your letter of July 28, 2005, co-signed by Ranking Minority Member Max Baucus, regarding the Food and Drug Administration's (FDA or the Agency) approval of Cyberonics, Inc.'s, Panel Track Pre-market Approval (PMA) Supplement for the Vagus Nerve Stimulation (VNS) Therapy to address treatment-resistant depression (TRD) in adults. Your letter expressed concern that FDA was not open and transparent in its website disclosure of safety and effectiveness information for VNS for TRD.

In particular, your letter quotes a statement by the Center for Devices and Radiological Health (CDRH) Director about the lack of a showing of effectiveness in the acute short-term 12-week data submitted by Cyberonics initially and suggests that this statement is inconsistent with statements about the device's effectiveness in the approved labeling. However, as discussed in the override memo, the results of the long-term data show statistically significant differences consistent with the claim that effectiveness of VNS for TRD does improve over time. Although not randomized and controlled, the long-term study was characterized by a high rate of patient accountability and follow-up, showing significant improvement over one and two years of treatment for a specific subset of severely depressed treatment resistant patients. In addition, the memo indicates that the Center Director considered the post-market experience with the device when used to treat severe epilepsy and the company's strong post-market plan. These considerations support the statement in Section X of the Summary of Safety and Effectiveness (SSE), Conclusions Drawn from Studies that Cyberonics provided "reasonable assurance of safety and effectiveness" of the VNS Therapy System for TRD.

Further, both the SSE and the patient labeling acknowledge the failure of the data to demonstrate short-term effectiveness. Section IX.2.c on page 13 of the SSE states clearly that VNS for TRD did not reach statistical significance at three months. Similarly, section 7.3 of the patient labeling states "the 12-week acute studies did not show a significant difference between patients receiving VNS therapy and those not receiving it." As discussed in the SSE, the labeling underwent "extensive review and modification to insure it fully informs physicians and patients of all known risks identified with use of the device in the TRD population as well as MDR information from the marketing experience for the epilepsy

Page 2 - The Honorable Charles E. Grassley

indication. Effectiveness information conforms to the information presented in the (SSE) clearly indicating that the benefit is not universal and requires long-term use and supervised management.”

In summary, FDA believes that the VNS for TRD approval information on its website, which includes the approval order, the SSE, and patient and physician (with black box warning) labeling information, is transparent regarding safety and effectiveness and will be useful to the public. We note that the approved indication limits the device to use in severely depressed individuals who have not responded adequately to four or more courses of anti-depressive treatment. These individuals will typically have undergone treatment using multiple different anti-depressant drugs, some of which have significant side effects, one or more courses of psychotherapy, and may have been treated with other modalities typically reserved for TRD, such as Electro-Convulsive Therapy, yet their depressive symptoms remain. We are confident that the information provided in the labeling and on FDA’s website will assist these patients and their doctors in making informed decisions about whether to have this device implanted.

Lastly, we would like to address your concern that the SSE posted on FDA’s website does not address “the level of scientific dissent within CDRH,” and that the Director’s comments regarding lack of effectiveness are not on the website at all. Please note that the SSE truthfully discloses that the effectiveness data of the short-term study “was not statistically significant.” The absence from the SSE of any discussion of internal discussions and the decision-making process that led to the approval reflects the policy of the Agency not to disclose pre-decisional and deliberative process information. This policy applies to all such information, and applies to product approval decisions regardless of whether initial approval decisions are overridden. The reasons for this policy are to encourage open and frank discussions among colleagues and between subordinates and superiors at FDA and to protect against public confusion that might result from disclosure of reasons and rationales that were not in fact ultimately the grounds for the Agency’s decision.

You ask that we inform you of any corrective actions we will take to address the concerns and issues in your letter. We have decided to review the CDRH Consumer Information page on our website ([www.fda.gov/cdrh/mda/docs/p970003s050.html](http://www.fda.gov/cdrh/mda/docs/p970003s050.html)) regarding the approval of the VNS Therapy System to see if it can be revised to provide even more helpful information for patients who are considering having VNS implanted for TRD. We will notify you if any changes are made.

We hope this information addresses your concerns. If you have further questions, please contact us. A similar letter has been sent to your co-signer.

Sincerely,



Patrick Ronan  
Associate Commissioner  
for Legislation



---

---

APPENDIX F—E-MAIL COMMUNICATIONS AND  
OTHER FDA DOCUMENTS

---

---

**HHS NEWS***U.S. Department of Health and Human Services*

---

P97-21  
 FOR IMMEDIATE RELEASE  
 July 16, 1997

FOOD AND DRUG ADMINISTRATION  
 Sharon Snider: (301) 443-3285  
 Consumer Hotline: (800) 532-4440

**FDA APPROVES MEDICAL DEVICE FOR EPILEPSY**

The FDA today approved the first medical device to help reduce seizures in people with epilepsy who have severe, uncontrolled seizures.

The approval came just 19 days after the positive recommendation of the Neurological Devices Panel of FDA's Medical Devices Advisory Committee. FDA received an application to market the product on Jan. 27 and expedited its review because of its potential importance for reducing seizures in people who lack effective, alternative treatment.

The device, called a vagus nerve stimulator, consists of a generator which is implanted under the collar bone like a pacemaker and connected by wire to the vagus nerve in the neck where it delivers electrical signals to the brain to control seizures. It includes an external programming system which is used by the physician to change stimulation settings. Patients can turn the stimulator on and off with a hand-held magnet by holding it over the stimulator.

The NeuroCybernetic Prosthesis System, made by Cyberonics, of Houston, was approved for use in conjunction with drugs or surgery in adults and adolescents with partial onset seizures, the type of seizures that begin in one part of the brain and may remain localized or become generalized to the entire brain.

"Vagus nerve stimulators offer people with uncontrolled seizures a new type of treatment," said Bruce Burlington, director of FDA's Center for Devices and Radiological Health. "While this device will not help everyone, it will reduce the frequency of seizures in many people."

Approximately 1.7 million Americans have epilepsy. Most seizures can be controlled by medication. However, about 200,000 people have seizures that cannot be fully or adequately controlled with drugs or surgery. Severe, ongoing seizures can lead to death.

FDA's approval of the device was based on a review of clinical studies on safety and effectiveness submitted by the manufacturer and on the recommendation of the Neurological Devices Panel.

In the studies, the device was implanted in 454 patients with poorly controlled seizures at 45 medical centers in the United States, Canada and Europe. The patients continued to take anti-seizure medication during the study.

In the most recent study, most patients showed at least some improvement with the vagus nerve stimulator. Half the patients treated had at least a 20 percent reduction in the number of seizures per day. In about 1 in 4, the frequency of seizures

decreased by more than 50 percent. In about 1 in 5, however, the number of seizures actually increased.

Side effects during stimulation included cough (50%), hoarseness (100%), voice alteration (73%), and shortness of breath (25%). However, these side effects were considered tolerable by most patients.

Nine patients died during the studies, but none of the deaths were believed by the clinical investigators to be caused by the device. Four deaths were classified as Sudden Unexpected Death in Epilepsy. The others resulted from drownings, pneumonia, liver failure and blood disease.

Although the death rate was not statistically higher than that expected for people with severe, poorly controlled seizures, FDA has asked Cyberonics to continue to provide detailed information about any further deaths, particularly any sudden unexpected deaths. The agency has also asked the company to further evaluate its study data to find out whether any factors predict which patients are the most likely and least likely to benefit from use of the device.

####

**ATTENTION TV BROADCASTERS: Please use open caption for the hearing impaired.**

---

FDA HOME PAGE

**From:** Project Manager  
**Sent:** Friday, October 03, 2003 2:03 PM  
**To:** Psychopharmacology Team Leader  
**Cc:** CDER Medical Reviewer; Review Team Leader; Branch Chief  
**Subject:** RE: VNS for Depression

Thank you for your message. Our division and branch will be very interested in discussing your points in your message below. I apologize that I was not able to suggest another meeting at the time I cancelled the post meeting. This was not a reflection that we did not want to meet. This week has been extremely overbooked with other staff commitments and meetings. Finding a time with our Division Director and key staff this week was not possible because of end of fiscal year meetings and commitments. I will be rescheduling this post meeting for next week, or the following, dependent on staffing schedules. If you would like, I can schedule a teleconference next week with our branch chief and lead reviewer. Please let me know. I will get back to you, by today or Monday at the latest with another date and time for the post meeting.

had also asked for the PMA number for this firm (Cyberonics). We have not officially received this firm's submission yet to the FDA, so we currently do not have an official PMA number assigned yet. When we do I will provide that information. The current file number I have for the pre-PMA meeting is IDE number G980099.

Let me know if I can provide additional assistance.

Thank you,

**Project Manager**  
 ?DA/CDRH/ODE/DGRND/REDB

-----Original Message-----

**From:** Psychopharmacology Team Leader  
**Sent:** Friday, October 03, 2003 12:09 PM  
**To:** Project Manager  
**Cc:** CDER Medical Reviewer  
**Subject:** VNS for Depression

I received notice that the post-meeting discussion with us had been cancelled without another suggested time. I am concerned that we are not getting our point across that the VNS for depression package that we reviewed represents a failed development program on face and that we would not file this as an NDA if it were a drug. We realize that you may have a different threshold for approval when it comes to devices because of the nature of the different diseases on which our respective Divisions are asked to comment. However, we tend to view treatments for depression based on the disease and not the therapeutic modality (psychotherapy, drug, ECT and now VNS). So it is artificial to us to consider one study for a device (that is negative on face) as sufficient to provide evidence for regulatory efficacy when we require positive studies for a drug.

Perhaps if this were a positive study (the short term part of it) with additional strongly supporting data from other work, then it would be another discussion about their short-term claims; however, they have a long list of long-term claims based on parts of rating scales and secondary efficacy variables. The long term claims are based on open-label data. We do not allow labeling claims based on open label studies that rely on historical controls in depression. Historical controls in depression are extremely unreliable.

We are very interested in follow-up regarding the future of this development plan.

Thanks,

**Psychopharmacology Team Leader**  
**DNDP**



**From:** Psychopharmacology Team Leader  
**Sent:** Wednesday, February 04, 2004 1:56 PM  
**To:** Review Team Leader; Branch Chief  
**Cc:** Psychopharmacology Team Leader; CDER Medical Reviewer  
**Subject:** Post approval study

I would like to point out that Cyberonics spent an hour telling why it was completely impossible for them to do a placebo controlled long-term (or short-term) study (even though other sponsors are doing this with TRD with drugs that we review in our Division without any reported trouble from IRBs or recruiting patients) but then, completely out of the blue; promised that if we approved the device that they would do such a study post approval.

I find this offer extremely puzzling since their argument centered around troubles with ethics, IRB cooperation, and patient recruitment. These are definitely not problems that would go away post approval.

I suggest that we note this lapse in logic in the minutes.

**Psychopharmacology Team Leader**

**USPHS**

-----Original Message-----

**From:** Malone, Richard

**Sent:** Thursday, June 17, 2004 10:18 AM

**To:** CDER Supervisory Medical Officer

**Subject:** VNA Device Meeting

I was a voting consultant at the FDA neurological Device Pane on 6/15/04. I would like to speak to you about this as I am deeply concerned about that meeting and its possible impact on public health and the treatment of psychiatric disorders.

The sponsor did not present convincing data that the treatment was effective, nor in my mind, that it was safe. The only blinded study with a control and with randomization to treatments was a failed study with regard to efficacy. The sponsor then presented open data that was weak to show efficacy.

The panel voted overall to approve the devise. I and the panel statistician, Dr. Ellenberg, voted for non-approval. Essentially, we both agreed that a treatment should be shown effective in a well-designed controlled trial. Drs. Rush and Sacheim (/sp) were sponsor consultants and they essentially said that in serious disorder, you don't need well-designed studies to show efficacy. Somehow you can just tell.

Can we speak?

This e-mail and any accompanying attachments are confidential. The information is intended solely for the use of the individual to whom it is addressed. Any review, disclosure, copying, distribution, or use of this e-mail communication by others is strictly prohibited. If you are not the intended recipient, please notify us immediately by returning this message to the sender and delete all copies. Thank you for your cooperation.

---

**From:** Neurological Devices Panel Member  
**Sent:** Friday, June 18, 2004 10:49 AM  
**To:** Panel Secretary, FDA  
**Subject:** Re: hello

Thanks If I were to have voted up front, I would have not approved the device. But since it appeared that the majority of folks wanted to approve it, Dr. Ellenberg's condition made no sense, so it seemed consistent to vote it down.

----- Original Message -----

**From:** Panel Secretary, FDA  
**To:** Neurological Devices Panel Member  
**Sent:** Thursday, June 17, 2004 8:34 AM  
**Subject:** hello

Hi,

I'm thinking of you. I didn't really get to talk to you afterwards. I hope you got home ok. I never had such a tense meeting, and I've had 13-14 of them.

Did you see the Wash Post article June 16, page A3? I wanted you to know that you were mentioned as casting the deciding vote on Dr. Ellenberg's last condition of approval so it was voted down. The Post described the meeting as tense, a day of clashing scientific opinions, and it mentioned Drs. Malone and Ellenberg.

We are getting other comment on the meeting. The decision is officially under review; this is what I will and am telling those who are asking. (I don't know when a decision will be issued nor what it will be.)

You could be contacted by the press, maybe financial analysts of whom there sure are many. Remember you don't have to talk to them. Some are polite and some aren't very. It may be easier not to talk because if other learned you talked to one, they will ring your phone off the hook. It is entirely your option. Let me know if you need anything from us.

I'm sorry you were in such a hot seat. You did admirably. It was tough. Thank you. I thought the CYBX speakers would never stop talking.

**From:** Review Team Leader  
**Sent:** Wednesday, October 20, 2004 10:03 AM  
**To:** Panel Secretary; DGRND Deputy Director; Branch Chief  
**Subject:** RE: From Panel Member Re: FDA's CES Homework and Comments on the VNS Decision

In the cursory review of information performed, some panel members may have confused increased risk of worsening depression with serious adverse events of worsening depression due to lack of effectiveness of VNS therapy. This is a good point I hope to address further in the review memo for Amendment 11.

-----Original Message-----

From: Panel Secretary  
 Sent: Tuesday, October 19, 2004 2:23 PM  
 To: DGRND Deputy Director; Branch Chief  
 Cc: Review Team Leader  
 Subject: From Panel Member Re: FDA's CES Homework and Comments on the VNS Decision

FYI

-----Original Message-----

From: Panel Member [mailto: ]  
 Sent: Tuesday, October 19, 2004 2:12 PM  
 To: Panel Secretary  
 Subject: Re: FDA's CES Homework

Yes. It's true. They've not gotten it yet. I've made some progress but have had a lot of unexpected clinical demands (the person who I usually trade coverage with was out for a number of weeks without warning). Will hope to have it finished by the end of next week.

I heard that the VNS device was disapproved. This was not surprising in and of itself, given the less than impressive nature of the data as well as the extreme ambivalence about the approval as reflected in the deliberations of the panel. I certainly was very ambivalent myself.

What I did find quite surprising was the specific notation of a risk of increased depression with the device. That was not something that I saw as a primary finding of the studies nor even one that was clearcut, if really present at all. I think its very hard to interpret "increased" symptoms as being attributable to a treatment that is being used to treat those symptoms to begin with. Part of my disagreement with the interpretation and final conclusions on the SSRI issues relates to just this sort of issue since there were differences in those analysis for suicidal thoughts and behaviors as lumped absolute measures in treated vs. placebo groups but no differences between the groups in onset or worsening of suicidal thoughts and behaviors making it hard to attribute causality to the meds. (at least in my mind). Don't know if the above is even intelligible, but was a similar issue operating in the inclusion of increased depression as a rationale for disapproving the VNS device?

Will get back to you soon on the homework.

---

**From:** ODE Deputy Clinical Director  
**Sent:** Tuesday, September 14, 2004 8:24 AM  
**To:** ODE Director  
**Subject:** Cyberonics VNS

I have finished looking over the slides and responses from Cyberonics.

The sponsor appears to be relying on the long-term data to support the effectiveness of the device. In particular:

1. That many patients who respond at 3 months continued to respond at 12 months
2. That a number of patients who did not respond at 3 months went on to respond at 12 months.

The sponsor notes that of the 56 subjects who had at least a meaningful response ( $>25\%$  reduction) at 3 months, 41 remained in that category at 12 months. However, we do not know what additional treatments were given to those 41 subjects and whether any of the "continued" benefit was due to this concomitant treatment. Furthermore, there are several drug trials where a significant portion of patients (~30-50%) on placebo maintained an effect out to 1 year or beyond. Of the 118 patients at 3 months who were rated minimally changed, unchanged or worse than baseline, 56 went on to at least a meaningful benefit ( $>25\%$  reduction) at month 12. But again, we do not know what additional treatments these 56 subjects received after month 3 which may have assisted them in achieving the new status. Also, it should be noted that these numbers include patients with a 25-50% reduction in score which was not in the original protocol's definition of success ( $\geq 50\%$  reduction) and the discussion of success which followed.

The "averages" in scores at 12 months may be deceptive and not entirely indicative of how each patient did. In addition, a spot assessment of depression at 12 months may be difficult to interpret in a disease that fluctuates over time. I therefore asked for the sponsor to provide month-by-month line data for those 55 subjects who were considered successes at 12 months as per the study protocol (e.g., had a decrease of  $\geq 50\%$  in symptom severity scale when compared to baseline score).

It should be noted that the sponsor chose to submit the data regarding the HRSD scale and not the IDS Scale which was the one chosen ahead of time as the endpoint for the long-term study. Whereas 30% of patients (55) met the success criteria based on the HRSD scale at 12 months, only 22% of patients (41) met the success criteria using the IDS scale. Right off the bat this is 14 additional patients who met the HRSD success criteria who did not succeed by the IDS criteria. Nevertheless, I have looked at the individual data from these 55 patients. The sponsor put the HRSD score on a graph along with medication/ECT information which showed when changes were made and the relative change in drug dosing. I was therefore able to look at when improvements in HRSD occurred and whether there were any changes in concomitant therapy which preceded those improvements (or worsening).

Of the 55 "successful" subjects, I felt fairly confident that changes in medications or ECT clouded the changes in HRSD enough to raise questions as to whether it was the device or not in 21 of these subjects, leaving 34 successful subjects where there were no obvious medication changes which paralleled changes in symptom score. This equates to ~18.5% of the evaluable patients who underwent 12 months of stimulation. However, there were some curious findings in several other remaining patient flow diagrams. For example, there were 7 cases where the 12-month HRSD score which earned the patient the "success" label was quite different and inconsistent with the scores in the 1-2 (or more) months preceding the final assessment. This raises questions about the persistent benefit (duration of benefit) which is argued by the sponsor. Although it may not be appropriate to eliminate these patients as

“successes”, if we did, the number of such would be 27, or 14.7%. There were also cases where the score was tending upwards over the last few months of the follow-up. Also of note, if the sponsor had provided the IDS data instead, knowing that fewer patients met the success criteria, I anticipate that if these same type of evaluation was done, we might see overall success rates (minus medication adjustments) of 10-15%.

The question becomes, are the “success rates” above within the realm of possibility for spontaneous remission? To address this I attempted to locate publications involving patients with so-called treatment-resistant depression where the patients were followed without therapy. I was only able to find one – a publication by Posternak and Zimmerman (Journal of Nervous and Mental Disease, 2000; 188(12):799-804) which looked at spontaneous improvement rates in 25 depressed outpatients. The median duration of illness was 104 weeks (2 years). The mean HRSD score at baseline was 23.2. There were 8 subjects who spontaneously improved with the longest time to recurrence out to 46 weeks (11+ months). Although the trial was small, the study did include 13 patients who were defined as documented treatment resistant at baseline. The study noted that 4 of the 13, or 31%, spontaneously remitted during the No Treatment Trial. The authors state that their findings may suggest that part of the placebo response seen in clinical trials may be due to the “natural ebb and flow of the disorder.” In other words, the natural history of the disease may account for some of the improvement seen.

I do not see anything in the information which would convincingly make me decide to overrule the original Division/Office decision.

**From:** Director of Office of Medical Policy  
**Sent:** Wednesday, November 24, 2004 7:53 PM  
**To:** Psychopharmacology Team Leader; ODE Deputy Clinical Director  
 Review Team Leader; DGRND Medical Officer; CDER DNDP Director  
**Cc:**  
**Subject:** RE: Change in Meeting Day/Time with Cyberonics  
 If I understand the situation, it would be a huge advance if they had even ONE controlled trial showing an effect, although depending on the study, I certainly agree that one should, for something so non-obvious, wish for confirmation. Are they, by the way, interested in “dose-response” (i.e., how long you have to keep it zapping?)

-----Original Message-----

**From:** Psychopharmacology Team Leader  
**Sent:** Wednesday, November 24, 2004 1:09 PM  
**To:** ODE Deputy Clinical Director  
**Cc:** Review Team Leader; DGRND Medical Officer; CDER DNDP Director; Director of Office of Medical Policy  
**Subject:** RE: Change in Meeting Day/Time with Cyberonics

I am a little troubled by what appears to be a request that I not discuss the need for replicated controlled data in our upcoming discussion with Cyberonics and CDRH Director. I am left with the impression that you may view our Division's opinion on the need for replicated controlled trial data as simply a bureaucratic policy difference between Centers. If this is true, then I hope to convince you otherwise. This need for replicated controlled clinical trial data is a basic tenet of psychiatric clinical research. This need is based on sad experience. I suggest that the need for two randomized controlled trials should actually be the focus of this upcoming meeting.

-----Original Message-----

**From:** ODE Deputy Clinical Director  
**Sent:** Wednesday, November 24, 2004 8:52 AM  
**To:** Psychopharmacology Team Leader  
**Cc:** Review Team Leader; DGRND Medical Officer  
**Subject:** RE: Change in Meeting Day/Time with Cyberonics

I met with CDRH Director last night and he said it would be perfectly fine for you to be present at the meeting next Wednesday with Cyberonics. He just asks that we limit our comments/discussion to the clinical data at hand and not bring up what would be required if this was a CDER/CBER submission (e.g., 2 randomized controlled studies).

**From:** Review Team Leader  
**Sent:** Monday, November 29, 2004 8:29 AM  
**To:** Branch Chief  
**Subject:** RE: CDRH Dir.'s decision

Yes I've heard. I've been invited to a meeting, in the absence of my management. I am very troubled about this decision, and suspect this is highly irregular.

-----Original Message-----

**From:** Branch Chief  
**Sent:** Wednesday, November 24, 2004 7:53 AM  
**To:** Review Team Leader  
**Subject:** CDRH Dir.'s decision

Don't know if you heard yesterday, but <sup>CDRH Dir</sup> has made a decision -- of sorts. His plan is to have a meeting with the company and the partial review team, for us to explain again why we came out to a different conclusion with the same data.

I'll be talking to <sup>ODE Director</sup> today, and explain why I think that's a really bad idea, but chances are that's what'll happen.

**From:** Review Team Leader  
**Sent:** Monday, December 27, 2004 8:44 AM  
**To:** Branch Chief  
**Cc:** Psychopharmacology Team Leader; DGRND Deputy Director; DGRND Medical Officer; DGRND Director; ODE Deputy Clinical Director  
**Subject:** RE: Cyberonics Protocols

After considerable thought, I would respectfully request you re-assign the current or any future submissions re VNS Therapy to another reviewer. Considering my scientific recommendation of not approvable based on the lack of clinical data supporting a reasonable assurance of safety or effectiveness and my knowledge of the ethical uncertainty in how they may have collected data in their epilepsy registry, I believe I have little to contribute in either the proposed dosage study or the post-market registry.

My final review memo on their latest supplement will be available this week to close out Amendment 11.

-----Original Message-----

**From:** ODE Deputy Clinical Director  
**Sent:** Wednesday, December 22, 2004 10:03 AM  
**To:** DGRND Medical Officer; Psychopharmacology Team Leader; Review Team Leader  
**Cc:** DGRND Director; DGRND Deputy Director  
**Subject:** FW: Cyberonics protocols

It is looking like <sup>CDRH Dir</sup> is leaning towards approval (reversal) of the Cyberonics VNS/Depression submission. Looks like he would be willing to do so if the sponsor could provide him with legitimate and useful post-market study. Last week they submitted one that he looked at and told them was grossly inadequate (it basically was a "physicians can give any electrical dose and any concomitant medications" type of study). It looks like they have now submitted two more proposals.

<sup>CDRH Dir</sup> is asking us to form a work-group with Epidemiology, Stats, and Clinical people to discuss the protocols and work on them to get a product that he feels comfortable with. I am trying to organize that team now. I already have the names of the Epi and Stats people and would like to include the three of you. Please let me know if you would be able to participate. I am hoping that people could look over the information during the holidays and that we can meet a couple of times in early January to work out the kinks.

I just wanted to stress that <sup>CDRH Dir</sup> is making the approval/disapproval decision and that is out of our hands now. However, he is still asking for our input and help with the one outstanding issue in his mind (the post-approval study issue). It will be tough for most if not all of us to look at a post-approval study in this context since we don't agree with the approval decision but we really have to look beyond that and address the issue <sup>CDRH Dir</sup> has asked of us.

I will be trying to set up some meetings on Outlook for early January. Please look for those hopefully later today.



## -----Original Message-----

**From:** Director, Office of Medical Policy  
**Sent:** Thursday, December 23, 2004 4:28 PM  
**To:** CDRH Director  
**Cc:** Deputy Commissioner for Operations  
**Subject:** Cyberonics

You've probably had as much input from everyone as you want, but I'm making an offer anyway. I believe the study they can and should do (whether realistically they can do it post-marketing is real question) is a randomized withdrawal study (in this case I guess that means turning off or turning down the machine in randomly chosen people). There are many practical advantages of this design. First, you're using patients who appear to be responders to the treatment, a substantial "enrichment" with people who should be able to show a drug effect; second, you don't have to wait till the rare patient suitable for the study turns up - they're already identified; third, the study can incorporate a "failure" or early stopping rule, such that as soon as a patient is doing badly they've reached an endpoint - you don't have to wait for 4, 8, 12, or whatever weeks to elapse, a major appeal for patients. These studies are do-able: they are the routine way antidepressants for maintenance are evaluated; the second study of GHB for narcolepsy used this design when it turned out they needed another study; this design was used to approve nifedipine for vasospastic angina when a totally inadequate "historical control" was presented to us - it took no time to find the 27 patients for the study (they were all taking the drug) and no time to do the study. The design has had many other uses too. If it would help, I'd be glad to discuss this further. It's hard to see what any post-marketing uncontrolled study can contribute, other than safety/tolerability data, of course.

-----Original Message-----

**From:** CDER Medical Officer  
**Sent:** Wednesday, January 12, 2005 10:53 AM  
**To:** Psychopharmacology Team Leader  
**Cc:** Director, Division of Neuropharmacological Drug Products  
**Subject:** VNS

I know I am not on this project anymore and am on neuro now, but I am disturbed that VNS might actually get an approval for "TRD". In my opinion, they do not have adequate data and I don't understand how this can move forward. I think you feel much the same but what will happen if the post-approval study is negative? Will the device be withdrawn? And, more importantly, it seems this type of data should come before approval.

I feel like I can't just sit back and watch this happen without asking if there is anything more we can do, for example, could we meet with Dir. Office of Med. Policy and Dep. Comm. for Operations about this? I am not trying to nag you about this but I feel strongly. As an M.D. with an interest in science, it seems to me that such an approval would be akin to approving an experimental product and is this what the FDA does?

Thanks.

**From:** ODE Deputy Clinical Director  
**Sent:** Tuesday, January 25, 2005 8:53 AM  
**To:** DGRND Medical Officer; Review Team Leader  
**Cc:** DGRND Director; DGRND Deputy Director  
**Subject:** Final Stages for Cyberonics

I think it is clear down here that CDRH Dir. is going to approve VNS for Depression. The post-market dosing study is going through its final paces. CDRH Dir. has assigned an ODE microbiologist and myself to review the labeling and the SSE that Cyberonics has submitted. I am writing to ask you whether you would be willing to take glances at the documents to help us out recognizing that no one knows the data as well as the two of you. I would not expect you to put a lot of time into it but just to point out major flaws, omissions, and "fluff" (as CDRH Dir. said). I know that both of you believe this product should not be approved (as do I) but CDRH Dir. is asking us to at least make sure there is truth in the labeling and I think that can be done regardless of our individual takes on the approvable/not approvable decision.

Please let me know.

Thanks

---

---

APPENDIX G—NEUROLOGICAL DEVICES PANEL MEETING

---

---

**PANEL QUESTIONS**

1. A chief limitation of the long-term D02, D04 comparative analysis is that the data are not derived from a randomized subject data set, but rather a comparison of outcomes from an investigational device study and observational control study. A propensity adjustment strategy was used to reduce potential bias (i.e., patient characteristics, disease characteristics) in the comparative analysis. This type of strategy is not able to address the problems of potential bias due to other unmeasured patient variables (e.g., past thyroid dysfunction, neurotic pre-morbid personality, familial predisposition for affective disorder, multiple loss events, or socio-cultural level). Please discuss the impact of a comparative analysis of non-randomized subject data, comparison of outcomes from an investigational study and observational study, and unmeasured patient variables upon efficacy outcomes in the PMA.
2. The Sponsor believes D02 long-term outcomes are not due to a placebo effect. Data provided in the PMA includes a 20% (21/106) placebo effect rate in sham-treatment control subjects at acute phase exit (12 weeks) as defined by a HAM-D score less than 18. Patient expectation of participating in an investigational study for a new therapy (D02 study) may have also been greater than the expectation of participating in an observational, control study. Please discuss the placebo effect and impact upon clinical outcomes presented in the PMA.
3. Concomitant medications and ECT use were not standardized in either the D02 long-term study or the D04 observational, control study. Please discuss the impact of concomitant medications and ECT use on interpretation of the efficacy of VNS therapy for treatment resistant depression.
4. 21 CFR 860.7(d)(1) states that there is a reasonable assurance that the device is safe when it can be determined that the probable benefits to health from use of the device for its intended uses, when accompanied by adequate instructions for use and warnings against unsafe use, outweigh any probable risks. Do the clinical data in P970003/S050 provide reasonable assurance that the device is safe?
5. 21 CFR 860.7(e)(1) states that there is a reasonable assurance that a device is effective when it can be determined, based on valid scientific evidence, that in a significant portion of the target population, the use of the device for its intended uses and conditions of use, when accompanied by adequate directions for use and warnings against unsafe use, will produce clinically significant results. Considering your responses to questions 1, 2, and 3, do the clinical data in P970003/S050 provide reasonable assurance that the device is effective?

---

---

APPENDIX H—MINUTES

---

---

## FDA Contact Report

**Dates of Contact:** March 1, 2002  
**Cyberonics Participants:** VP, Regulatory & Quality; Senior Director, Regulatory Affairs; VP, Clinical & Medical Affairs; Chairman & CEO; VP, Business & Technology Development  
**FDA Participants:** DGNRD Director; DGNRD Dep. Director; Branch Chief, Restorative Devices; Physiologist  
**Type of Meeting:** Teleconference  
**IDE Number:** IDE G980099 on Depression  
**Topic:** D-02 Protocol Revisions  
**Report Date:** March 21, 2002  
**Report Written By:** Senior Director, Regulatory Affairs  
**CC:** VP, Regulatory & Quality; Director and Senior Counsel, Regulatory Affairs; VP, Clinical & Medical Affairs; Regulatory Affairs Assistant

Sr. Dir, Reg. Affairs/VP, Clinical/Medical Affairs presented the slide presentation dated 02/26/02 during the call. See Attachment 1.

The notes below provide an overview of the discussion prompted by the slides during the teleconference.

DGNRD Director: We were as disappointed as you were in the results of the acute study. Depression is an important new indication.

DGNRD Director: Have you looked at the dose/response relationship and does there appear to be a relationship?

VP, Clin./Med. Affairs replied that the first of two potential contributors to the unexpectedly low D-02 treatment group response rate was the relatively low acute dose of VNS Therapy received by the D-02 patients compared to the acute doses received by the D-01 patients and by the epilepsy patients in the VNS Patient Registry. Cyberonics is only now beginning its review of all available acute and long-term depression and epilepsy data and various mechanism of action studies with regard to output current and response. Based on the data reviewed so far (a) there does not appear to be a relationship between output current and acute response specifically in D-02, but (b) the comparative analysis of response rates and output currents in D-02, D-01 and the epilepsy registry suggests that there may be such a relationship.

DGNRD Director: Before you go to slide 12, please explain slide 11: What are the conclusions from this slide?

VP, Clin./Med. Affairs replied that the level of treatment resistance in the D-02 patient population is the second of two potential contributors to the unexpectedly low treatment group response rate in D-02. When the D-01 data was analyzed to identify predictors of response, an inverse relationship between acute response and treatment resistance as measured by ATHF treatment failures in the current episode was found. The D-02 inclusion/exclusion criteria were revised to exclude those patients with no acute response in D-01 (patients with more than 6 ATHF treatment failures in the current episode). The patient characteristics shown on slide 11 suggest that the D-02 patient population was as treatment resistant and possibly more treatment resistant than the D-01 study patients.

DGNRD Director: Did you look at those two groups to see if the less resistant patients had better results than the more severe patients?

VP, Clin./Med. Affairs replied that the data might suggest that the D-02 patients are similar to the second cohort of D-01 patients. VNS may be more beneficial for patients earlier in intervention. However, we have not yet analyzed the D-02 results by level of treatment resistance.

CEO : mentioned the data presented by <sup>Principle Investigator</sup> <sub>Univ. of Texas</sub> at the FDA meeting in December showed that the only predictor of acute response in D-01 was the number of adequate (ATHF) failed treatments during the current episode. In other words, higher levels of treatment resistance would predict lower or delayed responses in that more treatment resistant population.

Sr. Dir, Reg. Affairs

## FDA Contact Report

VP, Clin./Med. Affairs stated that a working hypothesis right now is that similar to antidepressant medications, it may take VNS therapy longer to work in more treatment resistant patients.

DGNRD Director What do you mean by re-blinding?

Sr. Dir, Reg. Affairs commented on the "re-blinding" clarification and said that we were refraining from looking at any additional long-term data in an attempt to facilitate a prospective long-term analysis of D-02.

At the conclusion of the slide presentation DGNRD Director I cannot be very optimistic about this strategy (i.e., submitting the D-02 long-term data as a PMA Supplement). A lot of what you say is good. There is no question; you have good experience in epilepsy that would support the device's long-term safety. This patient population clearly needs more treatment options. But the issue now is how to demonstrate effectiveness compared to a valid control. Since you lost your control and both depression and this patient population are highly variable, it is unclear how you will demonstrate effectiveness. What improvement is clinically significant in this patient population?

VP, Clin./Med. Affairs responded that given the highly resistant patient population, it is thought that VNS therapy would contribute 15-25% improvement on top of best medical management. CEO replied that the difference in the D-02 Study to achieve statistical significance was 19%.

DGNRD Director As you know, the issue here for you and us is the validity of the control group. I am not convinced that you won't need another study such as the long-term comparative study (D-08) which you presented in December. What is the status of D-08?

Sr. Dir, Reg. Affairs stated that the study has not yet started and that Cyberonics is currently preparing responses to FDA's questions included in FDA's conditional approval of the D-08 Study.

VP, Clin./Med. Affairs mentioned that if it takes VNS therapy 6 months or longer to show response then a randomized, placebo control study would be problematic considering the severity of this patient populations' treatment resistant depression.

DGNRD Director This is something you are going to have to wrestle with. We recognize the importance of it and when we found out about the press report we were disappointed as well. A suggestion based on the presentation is if you find specific factors that point out a certain subgroup of the patients that this may work for, then you might be able to use a Bayesian analysis on a subset and design a smaller pivotal study. I am not sure how the data from the initial subgroup would be weighted in the final analysis. In any case, we will review anything you submit.

DGNRD Director Explain your thinking about possible control groups?

VP, Clin./Med. Affairs responded that the longitudinal repeated measure analysis using the D-02 patients' as controls was included in all FDA approval letters regarding the D-02 protocol. Cyberonics' statistical consultant was currently reviewing a variety of such repeated measure techniques. The long-term D-02 protocol provides for the collection of all the safety and effectiveness data to facilitate such an analysis. The other alternatives included the patients included in the D-04 companion study which was primarily a health economics study, and other treatment resistant cohorts from ECT and long-term drug studies. A significant challenge will be the identification of similar cohorts since the patients included in D-02 have been rarely studied and are excluded from most drug studies.

CEO asked about DGNRD Dir.'s opinion of the placebo group at acute exit as a control.

DGNRD Director Did not recommend the placebo group at acute exit as a confirmed control since they take the null hypothesis of skepticism. Again, without a randomized study, defining the control group is the biggest challenge.

DGNRD Director Suggested that a D-08 like study with a sample size similar to D-02 could potentially show a benefit for VNS over best pharmacotherapy and serve as a pivotal study to determine effectiveness.

**FDA Contact Report**

VP, Clin./Med. Affairs acknowledged the difficulties in finding matched pairs from non-randomized studies.

DGNRD Director: We appreciated the slides and this call to bring us up to date. I hope we were helpful. You obviously have a lot of work to do and we are available to review the additional analyses and your ideas regarding next steps.

This concluded the conference call.





## Memo

**To:** File  
**From:** Vice President, Regulatory & Quality  
**Date:** October 11, 2002  
 4:15 pm  
**Re:** **Phone Call Minutes, G980099/S52 (letter dated 10/04/02)**  
 After Scenario 1 presentation given, the following representative comments were made by  
 Director, Division of General & Restorative Neurological Devices  
 Branch Chief also sat in on the meeting.

---

The IDE-S application prepared and submitted by Cyberonics was clear and communicated very effectively the changes to the Stat Plan. Cyberonics' submissions are typically of very good quality.

The FDA was very disappointed in our acute D-02 results as the need for alternative depression treatments is great. The Expedited Review status granted by FDA acknowledged this need.

The FDA did not need to "approve" or "disapprove" this particular IDE-S that changed the proposed Stat Plan for the ongoing Depression Study.

After reviewing the IDE-S supplement, FDA does not believe that the new analysis plan will provide convincing evidence of effectiveness. However, FDA will, of course, review the data because, "the clinical data could be overwhelming and be accepted by many people". FDA agrees that, "the clinical data is key".

FDA understands that Cyberonics is not prepared to begin another study and that doing so before the D-02 data is analyzed would not be in the best interest of patients.

FDA agreed with Cyberonics that the October 24 meeting should be rescheduled as a pre-PMA meeting once the depression study clinical data has been analyzed and its statistical significance supports such a meeting. FDA is looking forward to this meeting.

The Branch Chief asked that Cyberonics notify by e-mail or call Consumer Safety Officer, and advise him that based upon this phone call, the October 24 meeting be cancelled. Cyberonics will reschedule a D-02 pre-PMA meeting early next year based upon analysis of the Depression Study clinical data supporting such a meeting.

---

DGRND Dir. thanked Cyberonics for the phone call.

100-DAY PMA-S MEETING MINUTES  
 VNS Therapy™ System for Treatment-Resistant Chronic or Recurrent Depression

**100-DAY PMA-S MEETING MINUTES**

VNS Therapy™ System for Treatment-Resistant Chronic or Recurrent Depression

<b>Date:</b> February 4, 2004		
<b>Time:</b> 12:00 – 1:30 pm (Eastern)		
<b>Type of Meeting:</b> 100-Day Meeting		
<b>Purpose of the Meeting:</b> To discuss the Substantive Review Issues identified to date.		
<b>Focused Questions Sponsor would like answered:</b> Determination of Panel Date.		
<b>Attendees:</b>		
<b>FDA</b>		
	, Division Director, General, Restorative and Neurological Devices	
	Deputy Director, General, Restorative and Neurological Devices	
	Branch Chief, Restorative Devices Branch	
	, Team and Lead Reviewer, General, Restorative and Neurological Devices	
	Statistician, Office of Device Evaluation	
(	Project Manager, Restorative Devices Branch	
	<b>BIMO</b>	
	, Psychopharmacology Medical Reviewer, CDER, by teleconference	
	, Psychopharmacology Team Leader, CDER, by teleconference	
	Panel Secretary	
<b>Cyberonics, Inc.</b>		
	Chairman of the Board and Chief Executive Officer	
	Vice President, Clinical and Medical Affairs and Chief	
	Medical Officer	
	Vice President, Regulatory and Quality	
	Senior Director, Regulatory Affairs	
	Senior Director, Clinical and Medical Affairs	
	Director and Senior Counsel, Regulatory Affairs	
	Medical Director, Clinical and Medical Affairs	
	Director, Biostatistics, Quintiles, Inc.*	
	Principle Investigator, University of Texas Southwestern MC, Dallas, Texas*	
*(available via telephone)		
<b>Agenda Item</b>	<b>Presented by</b>	<b>Proposed Time</b>
<b>1. Introduction</b>		
1.1 Introduction of Meeting Attendees	Senior Director Regulatory Affairs	5 min.
1.2 100-Day Meeting Agenda		
1.3 Discussion of appropriateness of Category C List		
<b>2. Discussion of Category C and other pertinent issues.</b>	VP, Med. Dir, Clinical/Medical Affairs Sr. Dir., Clinical/Medical Affairs Principle Investigator (by telephone)	65 min.
<b>3. Closing Remarks</b>	All	5 min.
<b>4. Executive Session: Dr.</b>	Discussion	15 min.
<b>Total Time</b>		<b>90 min.</b>

**Background Information:**

On January 28, 2004 a teleconference call was held to discuss the review status of the PMA-S including the planned facsimile containing the PMA-S substantive review issues as well as the upcoming 100-Day Meeting scheduled for February 4, 2004. During this teleconference call the list of issues was generally discussed including the manner in which Cyberonics should respond and associated preparations for the 100-Day Meeting. During the teleconference call FDA advised Cyberonics that a response to the preliminary list of items was not required prior to the 100-Day Meeting. Instead he recommended that a couple of key items be selected for discussion at the 100-Day Meeting. During this teleconference call Cyberonics requested that we change the 100-Day Meeting format from a teleconference meeting to a face-to-face meeting in Rockville, Maryland to which FDA agreed. Prior to the meeting Cyberonics submitted a 100-Day Meeting Package, which contained the proposed Meeting Agenda as well as the Meeting Materials which were based on the 51-issue list received by facsimile after the teleconference call on January 28, 2004.

**Meeting Minutes of 100-Day Meeting:**

After the intructions, and prior to the formal presentation from Cyberonics, FDA provided a summary of the PMA-S submission substantive review status:

- This complex PMA-S is currently under substantive review and is a work in progress. The list of items provided to Cyberonics on January 28, 2004 is a preliminary list of items associated with the substantive review.
- The intent of this meeting is not to provide executive answers to questions and make final decisions. The 100 day meeting is an open forum to discuss where we believe you are at in the review process and discuss the next steps that will be involved with in this process;
- FDA noted Cyberonics did a good job of interpreting and responding to the preliminary list of items as was voluntarily provided in the meeting materials in advance of the 100-day meeting. Not all FDA team members had the opportunity to review this package in full prior to the meeting. The meeting materials included a proposed agenda and preliminary responses to the 51 issues. FDA stated options for FDA action on this submission included either a not approvable letter or major deficiency letter, and after discussions with upper management, a major deficiency letter was determined.
- Based on the substantive review to date, the impression of the PMA-S is the following:
  - FDA has serious concerns whether this data set could support safety and effectiveness, because of the concerns with the study previously discussed.
  - The Depression PMA-S application will go to Panel. FDA would like to plan ahead so that a panel date can be planned for.

FDA stated these reservations regarding with the data would be part of the FDA review provided to panel members. FDA commented it would be beneficial to have a harmonious approach in moving to the Panel Meeting in which unresolved issues can be brought. FDA also stated that the Major Deficiency Letter would be sent soon and that the Panel Meeting date would be scheduled. Prior to setting a panel date it would be helpful if the sponsor could project a date that they feel they can respond to the Major Deficiency Letter (this should be a conservative estimate). Cyberonics commented they would have responses to the Major Deficiency Letter within two weeks of receiving the letter, which would allow FDA approximately twelve weeks to prepare for the Panel Meeting. The information will need to be submitted allowing time for review in order to hold the panel meeting on the date that will be scheduled.

FDA stated that the letter would most probably be a Major Deficiency Letter. FDA explained that the previously sent list of issues may not be a complete list since the review of the PMA-S is on-going and she also cautioned against making the assumption that the Major Deficiency Letter questions are a subset of the previously provided 51-items. It was further stated that the Major Deficiency Letter questions could not be provided interactively.

Lastly, FDA reiterated that the percentages provided in particular tables in the PMA-S needed corresponding raw data used to calculate these percentages (i.e. numerator and denominator).

Cyberonics introduced their presentation and meeting packet in response to the Substantive Review Issues/Questions fax received on January 28, 2004. The Meeting packet contained substantive review issues by category including Category A, clarifications that are addressed in the meeting materials; Category B, issues in which firm has no additional information to add (firm believes those issues have already been addressed in the PMA); and Category C, focus for the 100 day meeting.

On presentation of the slides, Cyberonics reviewed the following areas including Safety data, Effectiveness and Clinical Significance Issues, and Trial design as included in their power point presentation

The following items were noted:

- (1) Cyberonics discussed the handling of missing data in the data analysis as well as other items including the use of the non-VNS therapy patient group in the analysis of D-02 vs. D-04, the use of number of patients per year, data cut-off dates for safety and effectiveness analysis;
- (2) Cyberonics commented not much is published concerning "Worsening Depression" or "Treatment Resistant Depression" (TRD) and TRD patients are a different patient population than the usual "depressed" population that antidepressant clinical trials studied. FDA commented with regard to the safety data that they didn't guarantee that all issues were addressed, but that Cyberonics understood the issues and the responses at least started to address their concerns.
- (3) There was some discussion on clinical significance (including the measurement tools) in the TRD population compared to those populations studied in clinical drug trials (percentage improvement compared to baseline) and the relationship between statistical and clinical significance with respect to TRD populations (e.g. ECT patients). Also discussed was the expected placebo response in these different patient populations (very little in TRD vs. substantial in the usual "depressed" population). FDA asked Cyberonics about the 30 to 50% placebo response rate found in the literature. Cyberonics responded patients recruited into antidepressant drug trials are not a chronic population and a less resistant population when compared to the D-02 TRD population. One might expect to see between a 0 to 10% placebo response rates in these patients; however there exists little evidence for known placebo response rates in TRD populations.
- (4) The importance of "valid scientific evidence" as defined by FDA with respect to clinical trial design was emphasized. Cyberonics commented on additional clinical trial design and the comparison population for D-02 study patients as well as the potential difficulties of other trial designs including ethical issues, sample size, re-consent and blinding.

**100-DAY PMA-S MEETING MINUTES**

VNS Therapy™ System for Treatment-Resistant Chronic or Recurrent Depression

- (5) Cyberonics commented potential bias due to unblinding following the D-02 acute phase as well as the high concordance between the investigator and subject ratings, i.e. no matter which scale was used to collect data, there was high concordance between investigator and subject ratings.

At the close of the meeting FDA stated that they would review the PMA-S timeline with respect to the issuance of the Major Deficiency Letter. Upon issuance of the Major Deficiency Letter, if Cyberonics replied within approximately two weeks, then FDA would have approximately twelve weeks to complete final preparations for the Panel Meeting (). FDA complimented Cyberonics upon the preparation of the responses provided in the 100-Day Meeting Package. Cyberonics and FDA determined that there was no need for a separate Executive Session.

The meeting adjourned with both Cyberonics and FDA planning to share draft-meeting minutes as well as to complete the action items as assigned during the course of the meeting.

1. Cyberonics to provide electronic copy of slide presentation.	Sr. Counsel Reg. Affairs forwarded to FDA on 2/6/04
2. FDA to provide summary of meeting minutes.	In process
3. FDA to issue Major Deficiency Letter with Cyberonics' responses to follow thereafter.	In process
4. FDA to begin Panel Meeting scheduling preparations.	In process

Team Leader Concurrence: \_\_\_\_\_

Branch Chief Concurrence: \_\_\_\_\_

Division Director Concurrence: \_\_\_\_\_

**NOV 10 2004 REVIEW TEAM MEETING MINUTES**  
 VNS Therapy™ System for Treatment-Resistant Chronic or Recurrent Depression

**Date:** November 11, 2004  
**Time:** 12:00 – 1:00 pm (Eastern)  
**Type of Meeting:** Review Team Discussion  
**Purpose of the Meeting:** Internal FDA meeting to discuss Amendment Sponsor submission.  
**Focused Questions Sponsor would like answered:** Not applicable.  
**Attendees:**

**FDA**

- Team Leader, DNDP, CDER, by teleconference
- Division Director, DBS, CDRH
- Statistician, DBS, CDRH
- Biologist, DPS, OSB, CDRH
- Medical Officer, M.D., Ph.D., DPS, OSB,
- Team and Lead Reviewer, DGRND, CDRH
- Medical Reviewer, DNDP, CDER, by teleconference
- Branch Chief, DGRND, CDRH
- Branch Chief, DPS, OSB
- Team Leader, DBS, CDRH
- Division Director, DGRND, CDRH
- Project Manager, DGRND, CDRH

**Background Information:**

The Sponsor submitted Amendment to FDA to address the deficiencies listed in the not approvable letter dated August 11 2004. The additional information includes: a) Responses to each of the deficiencies listed in the not approvable letter, and b) Additional follow-up of patients implanted with the VNS Therapy System. A Review Team Meeting was convened to discuss the latest submission and whether the Sponsor satisfactorily addressed the deficiencies listed in the not approvable letter dated August 11 2004.

**Minutes of Review Team Meeting:**

The lead reviewer requested all primary reviewers to provide a brief summary of their memo:

The lead reviewer stated additional information in Amendment included two parts a) Responses to each of the deficiencies listed in the not approvable letter, and b) Additional follow-up data of patients implanted with VNS. The lead rev. noted responses to each of the deficiencies listed in the not approvable letter contained no new information, other than the clinical data

presented in the PMA, and such responses were inadequate. The lead reviewer also noted additional follow-up is lacking, considering the basic design flaws from which the data was originally collected. Lastly, the lead rev. noted a recent publication in Trivedi et al. (2004) that reported outcomes that argue against attributing the durability of outcomes in the D01 and D02 patients to the effectiveness of VNS since improvement was observed in very severe patients, improvement occurred with medical management, and considerable differences in patient management and follow-up vs. the control group was possibly a significant factor in improving clinical outcome in very severely depressed patients.

- The statistician stated additional evidence presented in Amendment was long-term data from a single arm of the D02 study and D-01 was designed as a feasibility study which may not be combined with the pivotal D-02 study due to difference in clinical sites, response outcomes, and others trial design issues. He commented without an appropriately designed, independent, randomized, double-blind, multi-center, controlled-trial, equal distribution of both observed and unobserved patient covariates between the VNS and control groups cannot be assured. He also commented it is not easy to separate the confounding effect of increased medications and/or electroconvulsive therapy (ECT) from the effect of vagus nerve stimulation. Lastly, he commented on the limitations of imputing missing data, as was observed in several analyses of the long-term clinical data .
- The biologist presented an analysis of reports on adverse events associated with VNS. She reported 1,887 patient events, that included 314 deaths, 1,148 injuries, and 425 malfunctions. Approximately one-third of the death events are of unknown etiology. Of the 1,887 patient events, 1,148 reported a serious injury. The most frequently reported serious injury was infection (n=312; 27%). Increased seizure activity was the second most frequently reported patient injury with 259 of the 1,148 (23%) reports. The biologist explained that the number of devices sold or VNS patient years was unknown and that OSB may follow-up with the Office of Compliance to examine these events, in comparison to devices sold commercially.
- The medical officer stated the purpose of her review was to provide a consult response to DGRND/ODE regarding the findings presented in the PMA P970003/ST0/A010 and address two specific questions including a) whether the patients with severe depression could be expected to improve by chance based on the latest data submitted by the Sponsor and the data from the relevant literature and b) is there a non-randomized, historical comparative study that can demonstrate the safety and effectiveness of VNS therapy for TRD. The medical officer reported data presented in the above submission do not provide sufficient scientific evidence to establish long-term efficacy for this device. Statistically significant positive long-term findings from controlled clinical trials are necessary to establish efficacy. She also reported there was not a non-randomized, historical comparative study that she believes can demonstrate the safety and effectiveness of VNS therapy for TRD
- Another med. officer reported the Sponsor had not provided any new data to support the safety of the VNS therapy in TRD. Since there are serious adverse events related to the use of the device, it cannot be considered “safe” without a documented benefit to offset these risks. He noted very little new information (not contained in the PMA, though it was presented at panel) was

presented in the latest amendment. This medical officer also commented on a recent paper by Trivedi et al that examined patients with chronic depression (average length of disease 13 years) using an algorithm guided treatment to adjust patients medication. He reported that this study demonstrated by simply changing the approach to medication (all patients and physicians had access to the same medications, only the approach to changes was different) can have an impact at 12 months similar to the differences seen between D02 and D04 and that with medical management, such responses are possible in severely affected patients.

The med. officer also proposed a series of alternative study designs, including a single arm study in which all enrolled patients are treated with VNS for 6 month, followed by a randomized phase in which half of the subjects have therapy withdrawn (turned off) and subjects are followed to a specified endpoint (3 months) or until they have complete regression of symptoms to pre-stimulation scores on depression rating scales. Such a design would allow for longer exposure to stimulation and eliminate the ethical issues since all patients are receiving therapy.

- The CDER team leader stated the Division of Neuropharmacological Drug Products (DNBP) has worked as a consultant to CDRH in review of the PMA for this indication for the past year. DNBP has consistently recommended that the Sponsor needed to produce two positive controlled trials to gain approval for a claim of efficacy in the treatment of TRD. He described the studies as open label trial data, in the absence of a positive, randomized controlled study. DNBP has a strong belief in the use of randomized controlled studies in the evaluation of mood disorders in general and TRD specifically. The use of open label trial data for approval is poorly supported by science and history. DNBP would consider the additional information presented in Amendment as an incomplete response.

The group collectively discussed the limitations of non-randomized controlled studies and examples of medical products (drug, device) that were believed to be safe and effective, and later disproved based on randomized controlled studies.

All attendees were asked to vote on whether the application should be approved, conditionally approved, or considered not approvable, considering the clinical data submitted in Amendment  
The following votes were noted:

9 Not Approvable; 1 abstention

The Division summarized to the group that a series of meetings were scheduled in the upcoming



weeks to bring this application review to closure. The Division would present the recommendation of the review team to the Office Director of the Office of Device Evaluation. The Division would update all review team members of the outcome of its recommendation to senior management at ODE and CDRH on this application.

Team Leader Concurrence: \_\_\_\_\_ 11.19.04

Branch Chief Concurrence: \_\_\_\_\_ 11/19/04

Division Director Concurrence: \_\_\_\_\_ 1/10/05



---

---

APPENDIX I—FDA ADVICE/GUIDANCE DOCUMENTS

---

---

**Please note: as of October 1, 2002, FDA charges fees for review of Premarket Notification 510(k)s and Premarket Approvals**

### Review Process

#### Overview

The review of a premarket approval application (PMA) is a four-step review process consisting of:

- administrative and limited scientific review by FDA staff to determine completeness (filing review);
- in-depth scientific, regulatory, and Quality System review by appropriate FDA personnel;
- review and recommendation by the appropriate advisory committee (panel review); and
- final deliberations, documentation, and notification of the FDA decision.

#### Filing a PMA (21 CFR, §14.42)

During the administrative and limited scientific review, FDA determines whether a PMA is suitable for filing by reviewing the PMA submission for information required by the FD&C Act, the PMA regulations (21 CFR 814), and Refuse to File policy. FDA has developed a [Checklist for Filing Decision for PMAs](#).

The filing of an application means that FDA has made a threshold determination that the application is sufficiently complete to begin an in-depth review. Within 45 days after a PMA is received by FDA, the agency will notify the applicant whether the application has been filed. The letter will include the PMA reference number and the date FDA filed the PMA. Expedited review status, if appropriate, may be communicated at this time. The date of filing is the date that a PMA accepted for filing was received by the agency. The 180-day period for review of a PMA starts on the date of filing.

FDA will refuse to file the application for substantive review if a PMA application does not meet a minimum threshold of acceptability. If the information or data are presented unclearly or incompletely or are not capable of withstanding rigorous scientific review, FDA may consider the PMA incomplete and not file it. If FDA refuses to file a PMA, FDA will notify the

applicant of the reasons for the refusal. This notice will identify the deficiencies in the application that prevent filing and will include the PMA reference number. FDA will advise the manufacturer of what information must be provided, or steps to be taken, to make the application fileable.

If FDA refuses to file the PMA, the applicant may:

- The applicant may resubmit the PMA with additional information necessary to comply with the requirements of section §515(c)(1)(A)-(G) of the FD&C Act and 21 CFR 814.20. A resubmitted PMA must include the PMA reference number of the original submission. If the resubmitted PMA is accepted for filing, the date of filing is the date FDA receives the resubmission.
- The applicant may request in writing within 10 working days of the date of receipt of the notice refusing to file the PMA, an informal conference with the Director of the Office of Device Evaluation to review FDA's decision not to file the PMA. FDA will hold the informal conference within 10 working days after receiving the request and will make its decision on filing within 5 working days after the informal conference. If FDA then accepts the PMA for filing, the date of filing will be the date of the decision to accept the PMA for filing. If FDA does not reverse its decision, the applicant may request reconsideration of the decision from the Director of the Center for Devices and Radiological Health. The Director's decision will constitute final administrative action for the purpose of judicial review.

Should the applicant decide to request a meeting concerning a refuse-to-file decision, the applicant must choose either: 1) an informal conference at which the decision not to file the application will be reviewed; or 2) a meeting with the ODE division to discuss the specific deficiencies and the measures necessary to correct these deficiencies. Please be advised that FDA will not typically grant requests for an informal conference and a meeting with the reviewing ODE division regarding this decision due to resource limitations. Applicants should either request an informal conference or schedule a meeting with the reviewing ODE division to discuss the preparation of an appropriate response.

FDA may refuse to file a PMA if FDA determines that any of the following applies:

- The application is incomplete because it does not contain all the information required under section 515(c)(1) (A)-(G) of the FD&C Act;
- The PMA does not contain each of the items required under Sec. 814.20 and justification for omission of any item is inadequate;
- The applicant has a pending Premarket Notification 510(k) with respect to the same device, and FDA has not determined whether the device falls within the scope of Sec. 814.1(c).
- The PMA contains a false statement of material fact.
- The PMA is not accompanied by a statement of either certification or disclosure as required by 21 CFR 54 Financial Disclosure by Clinical Investigators.

In-depth review (21 CFR 814.44)

FDA will begin substantive review of the PMA after it is accepted for filing (§814.42). During the review process, FDA will

notify the PMA applicant via major/minor deficiency letters of any information needed by FDA to complete the review of the application. The applicant may request to meet with FDA within 100 days of the filing of the PMA to discuss the review status of the application. The procedure for "Day-100 Meetings" can be found in the guidance document "Guidance on PMA Interactive Procedures for Day-100 Meetings and Subsequent Deficiencies - for Use by CDRH and Industry; Final" <http://www.fda.gov/cdrh/iodact/day100mt.html>  
<http://www.fda.gov/cdrh/iodact/day100mt.pdf>

If the applicant on their own initiative or at FDA's request submits a PMA amendment (§814.37) which contains significant new data from a previously unreported study, significant updated data from a previously reported study, detailed new analyses of previously submitted data, or significant required information previously omitted, the review period may be extended up to 180 days.

#### Panel Review (21 CFR 814.44)

FDA may refer the PMA to an outside panel of experts (advisory committee). In general, all PMAs for the first-of-a-kind device are taken before the appropriate advisory panel for review and recommendation. However, as soon as FDA believes that (1) the pertinent issues in determining the safety and effectiveness for the type of medical device are understood and (2) FDA has developed the ability to address those issues, future PMAs for devices of that type are not be taken before an advisory panel unless a particular application presents an issue that can best be addressed through panel review.

The PMA, or relevant portions, may be forwarded to each member of the appropriate FDA advisory committee for review. During the review process, FDA may communicate with the applicant (§814.37(b)) or with the advisory committee to respond to questions that may be raised by committee members or to provide additional information to the panel. FDA will maintain a record of all communications with the applicant and with the advisory committee.

If the PMA is referred to an advisory committee, the committee must hold a public meeting to review the PMA in accordance with 21 CFR 14. The advisory committee must submit a final report to FDA that includes the committee's recommendation and the basis for such recommendation on the PMA. The advisory committee report and recommendation may be in the form of a meeting transcript signed by the chairperson of the committee.

The following documents provide guidance for panel review.

Panel Review of Premarket Approval Applications 5/3/91 (P91-2)  
<http://www.fda.gov/cdrh/p91-2.html>

Criteria for Panel Review of PMA Supplements 1/30/86 (P86-3)  
<http://www.fda.gov/cdrh/p863.html>

FDA takes into consideration the transcript of the meeting, the panel's recommendation(s), and other information in reaching a final decision on the PMA. FDA informs the applicant whether FDA agrees with the panel's recommendation or disagrees and what additional information is needed from the applicant (approvable/not approvable decision). If the application is approvable, the applicant must agree to the "Conditions of Approval."

Notification of Approval (§814.44)

Within 180 days of the date of filing of the PMA (§814.40), FDA will complete its review of the PMA and of the advisory committee's report and recommendation and issue one of the following:

- o an approval order under §814.44(d),
- o an approvable letter under §814.44(e),
- o a not approvable letter under §814.44(f), or
- o an order denying approval under §814.45.

Approval Order

After FDA reviews the committee's final report, the FDA will issue an order to the applicant that the PMA is approved if none of the reasons in §814.45 (Denial of approval for a PMA) for denying approval of the application applies. FDA will approve an application on the basis of draft final labeling. Approval will be based on the condition that the applicant submits to FDA a copy of the final printed labeling before marketing.

FDA will notify the public of the approval. The announcement of the decision and the availability of a summary of the safety and effectiveness data (SSED) on which the decision is based will be published on the Internet at <http://www.fda.gov/cdrh/pmapage.html>. The summary will include information about any adverse effects of the device on health. The announcement also provides the applicant and other interested persons an opportunity for administrative review of the FDA approval under section 515(d)(3) of the FD&C Act. On a quarterly basis, FDA will publish a list of approvals announced during that quarter in the *Federal Register*. When a notice of approval is published, data and information in the PMA file will be available for public disclosure in accordance with §814.9.

Approvable Letter

FDA will send the applicant an approvable letter if the application substantially meets the requirements of the FD&C Act, and FDA believes that it can approve the application if specific additional information is submitted or specific conditions are agreed to by the applicant. The approvable letter will describe the information that FDA requires to be provided by the applicant or the conditions that the applicant is required to meet to obtain approval. FDA may require, for example, as a condition of approval:

- the submission of certain information identified in the approvable letter, such as final draft labeling;
- an FDA inspection that finds the manufacturing facilities, methods, and controls in compliance with the Quality System regulations (21 CFR 820) and, if applicable, verification of records pertinent to the PMA;
- restrictions imposed on the sale, distribution, or use of the device under section 515(d)(1)(B)(ii) or 520(e) of the FD&C Act, or

- postapproval requirements.

The applicant may have to agree to a postapproval study, restrictions on prescription use, or restrictions on the training of individuals who may use the device before approval. The applicant may also be notified of required postmarket surveillance and/or tracking requirements.

In response to an approvable letter, the applicant may:

- o amend the PMA as requested;
- o consider the approvable letter to be a denial of the PMA (21 CFR 814.45) and request administrative review [section 515(d)(3) of the FD&C Act] by filing a petition for reconsideration (21 CFR 10.33); or
- o withdraw the PMA.

Not approvable letter

FDA will send the applicant a not approvable letter if FDA believes that the application may not be approved for one or more of the reasons given in §814.45(a) or if FDA is unable to reach an approvable decision due to a lack of significant information in the application. The not approvable letter will describe the deficiencies in the application, including each applicable ground for denial under section 515(d)(2)(A)-(E) of the FD&C Act. When practical, FDA will identify what is necessary to make the PMA approvable. In response to a not approvable letter, the applicant may:

- amend the PMA as requested [such an amendment will be considered a major amendment under §814.37(c)(1)];
- consider the not approvable letter to be a denial of approval of the PMA (§814.45) and request administrative review under section 515(d)(3) of the FD&C Act by filing a petition for reconsideration (21 CFR 10.33); or
- withdraw the PMA.

FDA will consider a PMA to have been withdrawn voluntarily if:

- the applicant fails to respond in writing to a written request for an amendment within 180 days after the date FDA issues such a request;
- the applicant fails to respond in writing to an approvable or not approvable letter within 180 days after the date FDA issues such a letter; or
- the applicant submits a written notice to FDA that the PMA has been withdrawn.



Service of orders (21 CFR 814.17)

Any FDA orders, such as approval or denial, will generally be faxed and then sent to the PMA applicant or its designated agent by mail. A PMA applicant or its designated agent may arrange to pick up the FDA order at 9200 Corporate Blvd., Rockville, Maryland 20850 by contacting the PMA Staff at 301-594-2186.

Standard Conditions of Approval

The "Conditions of Approval" are the standard postapproval conditions imposed by FDA. These are applicable to all original PMAs and PMA supplements. As a condition of approval the sponsor agrees to abide by advertising and final printed labeling requirements and to submit adverse event reports, annual reports, and PMA supplements for certain changes. Additional specific conditions may be required for implanted devices. Applicants should carefully read the conditions of approval enclosed with the FDA approval letter. The "Conditions of Approval" is available on the Internet <http://www.fda.gov/cdrh/devadv/vice/pma/conditions.html>

PMA Amendments 814.37

An applicant may amend a pending PMA or PMA supplement to revise existing information or to provide additional information.

FDA may request the applicant to amend a PMA or PMA supplement with any information regarding the device that is necessary for FDA or the appropriate advisory committee to complete the review of the PMA or PMA supplement.

A PMA amendment submitted to FDA shall include the PMA or PMA supplement number assigned to the original submission and, if submitted on the applicant's own initiative, the reason for submitting the amendment. FDA may extend the time required for its review of the PMA or PMA supplement.

If the applicant on its own initiative or at FDA's request submits a major PMA amendment (e.g., an amendment that contains significant new data from a previously unreported study, significant updated data from a previously reported study, detailed new analyses of previously submitted data, or significant required information previously omitted), the review period may be extended up to 180 days.

If an applicant declines to submit a major amendment requested by FDA, the review period may be extended for the number of days that elapse between the date of such request and the date that FDA receives the written response declining to submit the requested amendment.

Resubmitted PMAs 814.37

Applicants may voluntarily withdraw their PMA or PMA supplement. If FDA requests an applicant to submit a PMA amendment, and a written response to FDA's request is not received within 180 days, FDA will consider the pending PMA or PMA supplement to be withdrawn voluntarily by the applicant (abandoned).

An applicant may resubmit a PMA or PMA supplement that was withdrawn, that FDA has refused to accept for filing, or that FDA has denied approval. A resubmitted PMA or PMA supplement must comply with the requirements of §814.20 or §814.39 and must include the PMA number assigned to the original submission as well as the applicant's reason for resubmission.

[\[back to top\]](#)

#### **Steps in the PMA Application Process**

- ODE filing review
- OSB statistical review for filing
- OC review of manufacturing information for compliance with the Quality System regulation (21 CFR 820).
- PMA filing decision
- Day-100 Meeting
- Quality System Inspection(s) by the FDA field personnel. An FDA manufacturing inspection is conducted for all original PMAs and may be conducted for PMA supplements requesting approval of alternate or additional manufacturing and sterilization facilities.
- Bioresearch Monitoring (BIMO) Audit (audit of clinical study data)
- Substantive review coordination and completion in areas such as:
  - Preparation of FDA Summary of Safety and Effectiveness Data (SSED)
  - Nonclinical Studies  
[Microbiological, Toxicological, Immunological, Biocompatibility, Shelf Life, Analytical (for IVDs), Animal, Engineering (Stress, Wear, Fatigue, etc.)]
  - Clinical Studies
- Panel Meeting Decision and Mailing (if panel meeting is appropriate)
- Panel Date (if appropriate)

- Transcripts Received, Reviewed and Placed in Administrative Record
- QS/GMP Clearance
- Final Response from OC for GMP/BIMO
- Final ODE Decision Memo
- Approval Package

. Approval Order, , SSED, Final Draft Labeling

[\[back to top\]](#)

#### **Early Collaboration**

Applicants are encouraged to contact FDA to obtain further guidance prior to the submission of a PMA application. This will be especially beneficial to new applicants who have not previously had contact with FDA and for applicants proposing to study new technologies or new uses for existing technologies. Early interaction with FDA should help to increase the applicant's understanding of FDA requirements, regulations, and guidance documents, and will allow FDA personnel to familiarize themselves with the new technologies. Increased interaction between FDA and applicants should help to speed the regulatory process and minimize delays in the development of useful devices intended for human use.

The applicant may request a "PrePMA determination" meeting with FDA. This meeting held early in device development will provide the applicant with the agency's determination of the type of valid scientific evidence that will be necessary to determine if the device is effective for its intended use. Additional information on early collaborations meetings can be found in "Early Collaboration Meetings under the FDA Modernization Act (FDAMA)" <http://www.fda.gov/cdrh/ode/guidance/310.pdf>

Once the applicant understands the review process through FDA regulations and guidance documents, the applicant is encouraged to contact the review divisions within the Office of Device Evaluation to discuss device-specific requirements. The PMA staff may be contacted for general questions relating to the PMA laws, regulations, policies, and administrative issues on (301) 594-2186.

[\[back to top\]](#)

#### **FDA Action On a PMA**

[Denial of approval of a PMA \(§814.45\)](#)

FDA may deny approval of a PMA if the applicant fails to follow the requirements of the PMA regulation or if FDA determines

that any of the grounds for denying approval of a PMA specified in section 515(d)(2)(A)-(E) of the FD&C Act applies. In addition, FDA may deny approval of a PMA for any of the following reasons:

- The PMA contains a false statement of material fact.
- The device's proposed labeling does not comply with the requirements in Part 801, Labeling, or Part 809, In Vitro Diagnostic Products for Human Use.
- The applicant does not permit an authorized FDA employee to inspect the facilities and controls in which the device will be manufactured or to have access to and to copy and verify all records pertinent to the application
- An essential nonclinical laboratory study described in the PMA was not conducted in compliance with the good laboratory practice (GLP) regulations in 21 CFR 58 and no reason for the noncompliance is provided, or, if it is, the differences between the practices used in conducting the study and the good laboratory practice regulations do not support the validity of the study.
- Any clinical investigation involving human subjects described in the PMA that is subject to the Institutional Review Board regulations in 21 CFR 56 or to the Informed Consent regulations in 21 CFR 50 and was not conducted in compliance with these regulations such that the rights or safety of human subjects were not adequately protected.

FDA will issue any order denying approval of a PMA in accordance with §814.17. The order will inform the applicant of the deficiencies in the PMA, including each applicable ground for denial under section 515(d)(2) of the FD&C Act and the regulations under Part 814, and, where practical, will identify measures required to place the PMA in approvable form. The order will include a notice of an opportunity to request review under section 515(d)(3) of the FD&C Act.

FDA will use the criteria specified in §860.7 (Determination of Safety and Effectiveness) in deciding whether to approve or deny approval of a PMA. FDA may use information other than that submitted by the applicant in making such determination.

FDA will publish a *Federal Register* notice of an order denying approval of the PMA. The notice will be placed on the Internet (<http://www.fda.gov/cdrh>) and will state that a detailed summary of information concerning the safety and effectiveness of the device, including information about any adverse effects on health, is available on the Internet and has been placed on public display. FDA will publish in the *Federal Register* after each quarter a list of the denials announced in that quarter. When a notice of denial of approval is made publicly available, data and information in the PMA file will be available for public disclosure in accordance with §814.9.

FDA will issue an order denying approval of a PMA after an approvable or not approvable letter has been sent and the applicant has:

- submitted the requested amendment but any ground for denying approval under section 515(d)(2) of the FD&C Act still applies; or

- notified FDA in writing that the requested amendment will not be submitted; or
- petitioned for review under section 515(d)(3) of the FD&C Act by filing a petition in the form of a petition for reconsideration (21 CFR 10.33).

Withdrawal of approval of a PMA (21 CFR 814.46)

FDA may issue an order withdrawing approval of a PMA if FDA determines from any information available that:

- any of the grounds under section 515(e)(1)(A)-(G) of the FD&C Act applies;
- any postapproval requirement imposed by the PMA approval order or by regulation has not been met;
- an essential laboratory study described in the PMA was not conducted in compliance with the GLP regulations in 21 CFR 58 and no reason for the noncompliance is provided or, if it is, the differences between the practices used in conducting the study and the GLP regulation do not support the validity of the study; or
- any clinical investigation involving human subjects described in the PMA that is subject to the IRB regulations in 21 CFR 56 or to informed consent regulations in 21 CFR 50, was not conducted in compliance with these regulations, such that the rights or safety of human subjects were not adequately protected.

FDA may seek advice on scientific matters from any appropriate FDA advisory committee in deciding whether to withdraw approval of a PMA. FDA may also use information other than that submitted by the applicant in deciding whether to withdraw approval of a PMA.

Before issuing an order to withdraw approval of a PMA, FDA will issue the holder of the approved application a notice of opportunity for an informal hearing under 21 CFR 16. If the applicant does not request a hearing or, if after the 21 CFR 16 hearing is held, FDA decides to proceed with the withdrawal, FDA will issue an order withdrawing approval of the application. The order (§814.17) will state each ground for withdrawing approval and will include a notice of an opportunity for administrative review under section 515(e)(2) of the FD&C Act.

FDA will publish a *Federal Register* notice of an order withdrawing approval of a PMA. The notice will state that a detailed summary of information concerning the safety and effectiveness of the device, including information about any adverse effects on health, has been placed on public display and that copies are available upon request. When a notice of withdrawal of approval is published, data and information in the PMA file will be available for public disclosure under §814.9.

Temporary Suspension of Premarket Approval (§814.47)

If, after providing the sponsor with an opportunity for a regulatory informal hearing regarding the proposed withdrawal of PMA approval, and FDA determines there is a reasonable probability that continued distribution of a PMA-approved device

would cause serious adverse health consequences or death, FDA shall by order temporarily suspend the PMA. In cases where there is sufficient grounds, FDA will proceed expeditiously to withdraw the PMA approval.

[\[back to top\]](#)

#### **References**

Section 515 of the Federal Food, Drug, and Cosmetic Act  
<http://www.fda.gov/opacom/laws/fdcact/fdcact5a.htm>

#### 21 CFR 814

PMA Refuse to File Procedures (P94-1)  
<http://www.fda.gov/cdrh/pma941.html>

PMA Filing Decision (P90-2)  
<http://www.fda.gov/cdrh/pma90-2.html>

Checklist for Filing Decision for PMA  
<http://www.fda.gov/cdrh/ode/checklist/pma.html>

Clinical Utility and Premarket Approval (P91-1)  
<http://www.fda.gov/cdrh/p91-1.html>

Panel Review of Premarket Approval Applications 5/3/91 (P91-2)  
<http://www.fda.gov/cdrh/p91-2.html>

Criteria for Panel Review of PMA Supplements 1/30/86 (P86-3)  
<http://www.fda.gov/cdrh/p863.html>

Panel Review of PMAs for "Me Too" Devices 7/25/86 (P86-6)  
<http://www.fda.gov/cdrh/p866.html>

[\[back to top\]](#)

**Please note: as of October 1, 2002, FDA charges fees for review of Premarket Notification 510(k)s and Premarket Approvals**

**Clinical Studies**

**Investigational Device Exemption (\$812)**

Clinical studies on human subjects that is conducted within the United States and U.S. territories must comply with Good Clinical Practices regulations. These regulations include Investigational Device Exemption (IDE) under 21 CFR 812, Protection of Human Subjects under 21 CFR 50, and Institutional Review Boards under 21 CFR 56. Guidance on these requirements can be found on the CDRH website at <http://www.fda.gov/cdrh/devadvice/ide/index.shtml>

[back to top]

**Research conducted outside the United States (\$814.15)**

A study conducted under an investigational device exemption (IDE) outside the United States and submitted in support of a PMA must comply with the IDE regulation (21 CFR 812). A study conducted outside the U.S. which was not conducted under an IDE must comply with one of the following:

- Research begun on or after effective date November 19, 1986: FDA will accept studies which have been conducted outside the U.S. and begun on or after November 19, 1986, if the data constitute valid scientific evidence (\$860.7) and the investigator has conducted the studies in conformance with the "Declaration of Helsinki" or the laws and regulations of the country in which the research was conducted, whichever offers greater protection to the human subjects. If the standards of the country are used, the applicant must state in detail any differences between those standards and the Declaration of Helsinki and explain why the national standards offer greater protection to the human subjects.
- Research begun before effective date November 19, 1986: FDA will accept studies which have been conducted

outside the U.S. and begun before November 19, 1986, if the agency is satisfied that the data constitute valid scientific evidence (§860.7) and that the rights, safety, and welfare of human subjects have not been violated.

A PMA based solely on foreign clinical data and otherwise meeting the criteria for approval under this part may be approved if:

- the foreign data are applicable to the U.S. population and medical practice;
- the studies have been performed by clinical investigators of recognized competence; and
- the data may be considered valid without the need for an on-site inspection by FDA or, if FDA considers such an inspection to be necessary, FDA can validate the data through an on-site inspection or other appropriate means.

Applicants who seek approval based solely on foreign data are encouraged to meet with FDA officials in a presubmission meeting.

Additional guidance on FDA policy regarding the acceptance of foreign clinical data can be found in the following documents:

Acceptance of Foreign Clinical Studies; Guidance for Industry

<http://www.fda.gov/cder/guidance/fststud.htm>

<http://www.fda.gov/cder/guidance/fststud.pdf>

Declaration of Helsinki

<http://www.fda.gov/oc/health/helsinki89.html>

(World Medical Association's recommendations to every physician in biomedical research involving human subjects)

[\[back to top\]](#)

#### **Determination of Safety and Effectiveness (§860.7)**

##### Relevant Factors

In determining the safety and effectiveness of a device for Premarket Approval of class III devices, FDA will consider the following, among other relevant factors:

1. The persons for whose use the device is represented or intended;
2. The conditions of use for the device, including conditions of use prescribed, recommended, or suggested in the labeling or advertising of the device, and other intended conditions of use;



3. The probable benefit to health from the use of the device weighed against any probable injury or illness from such use; and
4. The reliability of the device.

#### Valid Scientific Evidence

Although the manufacturer may submit any form of evidence to the FDA in an attempt to substantiate the safety and effectiveness of a device, the FDA relies upon only valid scientific evidence to determine whether there is reasonable assurance that the device is safe and effective. After considering the nature of the device and the rules in §860.7, FDA will determine whether the evidence submitted or otherwise available to the FDA is valid scientific evidence for the purpose of determining the safety or effectiveness of a particular device and whether the available evidence, when taken as a whole, is adequate to support a determination that there is reasonable assurance that the device is safe and effective for its conditions of use.

Valid scientific evidence is evidence from well-controlled investigations, partially controlled studies, studies and objective trials without matched controls, well-documented case histories conducted by qualified experts, and reports of significant human experience with a marketed device, from which it can fairly and responsibly be concluded by qualified experts that there is reasonable assurance of the safety and effectiveness of a device under its conditions of use. The evidence required may vary according to the characteristics of the device, its conditions of use, the existence and adequacy of warnings and other restrictions, and the extent of experience with its use. Isolated case reports, random experience, reports lacking sufficient details to permit scientific evaluation, and unsubstantiated opinions are not regarded as valid scientific evidence to show safety or effectiveness.

#### Safety

There is reasonable assurance that a device is safe when it can be determined, based upon valid scientific evidence, that the probable benefits to health from use of the device for its intended uses and conditions of use, when accompanied by adequate directions and warnings against unsafe use, outweigh any probable risks. The valid scientific evidence used to determine the safety of a device must adequately demonstrate the absence of unreasonable risk of illness or injury associated with the use of the device for its intended uses and conditions of use.

Among the types of evidence that may be required, when appropriate, to determine that there is reasonable assurance that a device is safe are investigations using laboratory animals, investigations involving human subjects, and nonclinical investigations including *in vitro* studies.

#### Effectiveness

There is reasonable assurance that a device is effective when it can be determined, based upon valid scientific evidence, that in a significant portion of the target population, the use of the device for its intended uses and conditions of use, when accompanied by adequate directions for use and warnings against unsafe use, will provide clinically significant results. The valid scientific evidence used to determine the effectiveness of a device shall consist principally of well-controlled investigations.

#### Well-Controlled Clinical Investigation

The following principles are recognized by the scientific community as the essentials of a well-controlled clinical investigation. They provide the basis for FDAs determination whether there is reasonable assurance that a device is effective based upon well-controlled investigations and are also useful in assessing the weight to be given to other valid scientific evidence.

The plan or protocol for the study and the report of the results of a well-controlled investigation shall include the following:

1. A clear statement of the objectives of the study;
2. A method of selection of the subjects that:
  - a. Provides adequate assurance that the subjects are suitable for the purposes of the study, provides diagnostic criteria of the condition to be treated or diagnosed, provides confirmatory laboratory tests where appropriate and, in the case of a device to prevent a disease or condition, provides evidence of susceptibility and exposure to the condition against which prophylaxis is desired;
  - b. Assigns the subjects to test groups, if used, in such a way as to minimize any possible bias;
  - c. Assures comparability between test groups and any control groups of pertinent variables such as sex, severity or duration of the disease, and use of therapy other than the test device;
3. An explanation of the methods of observation and recording of results utilized, including the variables measured, quantitation, assessment of any subject's response, and steps taken to minimize any possible bias of subjects and observers;
4. A comparison of the results of treatment or diagnosis with a control in such a fashion as to permit quantitative evaluation. The precise nature of the control must be specified and an explanation provided of the methods employed to minimize any possible bias of the observers and analysts of the data. Level and methods of "blinding," if appropriate and used, are to be documented. Generally, four types of comparisons are recognized:
  - a. No treatments.
 

Where objective measurements of effectiveness are available and placebo effect is negligible, comparison of the objective results in comparable groups of treated and untreated patients;
  - b. Placebo control.
 

Where there may be a placebo effect with the use of a device, comparison of the results of use of the device with an ineffective device used under conditions designed to resemble the conditions of use under investigation as far as possible;
  - c. Active treatment control.
 

Where an effective regimen of therapy may be used for comparison, e.g., the condition being treated is such that the use of a placebo or the withholding of treatment would be inappropriate or contrary to the interest of the patient;

d. Historical control.

In certain circumstances, such as those involving diseases with high and predictable mortality or signs and symptoms of predictable duration or severity, or in the case of prophylaxis where morbidity is predictable, the results of use of the device may be compared quantitatively with prior experience historically derived from the adequately documented natural history of the disease or condition in comparable patients or populations who received no treatment or who followed an established effective regimen (therapeutic, diagnostic, prophylactic).

5. A summary of the methods of analysis and an evaluation of the data derived from the study, including any appropriate statistical methods utilized.

To insure the reliability of the results of an investigation, a well-controlled investigation shall involve the use of a test device that is standardized in its composition or design and performance.

[\[back to top\]](#)

#### Data Analysis

The PMA application must include a discussion of the conclusions drawn from studies conducted with the medical device [§14.20(3)(vi)]. FDA does not prescribe specific statistical analyses for given devices and/or situations. All statistical analyses used in an investigation should be appropriate to the analytical purpose, and thoroughly documented.

The discussion should demonstrate that the data and information in the application constitute valid scientific evidence within the meaning of §860.7 (discussed above) and provide reasonable assurance that the device is safe and effective for its intended use. The indications for use is based on the nonclinical and clinical studies described in the PMA. Indications for use for a device include a general description of the disease or condition the device will diagnose, treat, prevent, cure, or mitigate, including a description of the patient population for which the device is intended. Any differences related to gender, race, ethnicity, or age, etc. should be discussed in the data analysis and included in the labeling.

The concluding discussion must present benefit and risk considerations related to the device including a discussion of any adverse effects of the device on health and any proposed additional studies or surveillance the applicant intends to conduct following approval of the PMA.

The analysis should include the following:

- Summary of results (graphs are helpful)
- Summary of the study subjects including the number of subjects who have prematurely discontinued participation. (Include patient tree and spreadsheets to provide full accounting of all study subjects including controls and drop-outs, as appropriate)
- Description of events potentially affecting study success (e.g., difficulties enrolling patients; changes in key personnel;

- discontinuation of participation by subjects and investigators)
- Summary of anticipated and unanticipated adverse effects
- Description of any deviations from the investigational plan by investigators
- Discussion of any missing data and how it impacts the study
- Description of method of statistical analyses used; describe how any assumptions required in the statistical analysis were validated
- Comparison of results to success/failure criteria
- Conclusions drawn from study, relate back to indications for use and how the data supports each indication

Additional guidance can be found in the following documents:

Clinical Utility and Premarket Approval, Blue Book Memo #P91-1  
<http://www.fda.gov/cdrh/pg91-1.html>

Statistical Guidance for Clinical Trials of Non Diagnostic Medical Devices  
<http://www.fda.gov/cdrh/ode/ot476.html>

Perspectives on Clinical Studies for Medical Device Submissions (Statistical) <http://www.fda.gov/cdrh/ode/78.pdf>

[\[back to top\]](#)

### **Bioresearch Monitoring**

Sponsors, IRBs, and investigators, or any person acting on their behalf, are required to permit authorized FDA employees reasonable access at reasonable times to inspect and copy all records relating to clinical and nonclinical investigations. Furthermore, if FDA has reason to suspect that adequate informed consent was not obtained or that reports required to be submitted by the investigator to the sponsor or IRB have not been submitted or are incomplete, inaccurate, false, or misleading, FDA may inspect and copy records that identify subjects.

To assure compliance with the IDE and related regulations, FDA inspects sponsors, clinical investigators, and institutional review boards. Nonclinical laboratories that perform animal studies in which the data are used to support research or marketing permits are included in the inspection program. The inspection program is referred to as bioresearch monitoring (BIMO) and is overseen the CDRHs Office of Compliance, Division of Bioresearch Monitoring.

The objectives of the bioresearch monitoring program are to ensure the quality and integrity of data and information submitted in support of PMA and IDE submissions and to ensure that human subjects taking part in investigations are protected from undue hazard or risk. This is achieved through site audits of clinical data contained in PMAs prior to approval, data audits of IDE submissions, and inspections of Institutional Review Boards and nonclinical laboratories.

Additional guidance on FDA's biological monitoring program can be found in the documents:

§812.145

Bioresearch Monitoring Agreement for PMAs and PDPs  
<http://www.fda.gov/cdrh/ode/p98-1.html>

Integrity of Data and Information Submitted to ODE May 29, 1991 (I91-2)  
<http://www.fda.gov/cdrh/i91-2.html>

Device Advice: Clinical Trials and Investigational Device Exemption  
<http://www.fda.gov/cdrh/devadvice/ide/enforcement.shtml>

Office of Compliance - Bioresearch Monitoring Program  
<http://www.fda.gov/cdrh/comp/bimogen.html>

Application Integrity Policy  
[http://www.fda.gov/ora/compliance\\_ref/rpm\\_new2/rpm10aip.html](http://www.fda.gov/ora/compliance_ref/rpm_new2/rpm10aip.html)

Office of Regulatory Affairs; Compliance References; Bioresearch Monitoring (BIMO)  
[http://www.fda.gov/ora/compliance\\_ref/bimo/default.htm](http://www.fda.gov/ora/compliance_ref/bimo/default.htm)

FDA/Office of Regulatory Affairs  
Application Integrity Policy Information  
[http://www.fda.gov/ora/compliance\\_ref/aip\\_page.html](http://www.fda.gov/ora/compliance_ref/aip_page.html)

[\[back to top\]](#)

Please note: as of October 1, 2002, FDA charges fees for review of Premarket Notification 510(k)s and Premarket Approvals

## PMA Supplements and Amendments

### Overview

Amendments (§ 814.37) or supplements (§814.39) are submitted to FDA for changes or revisions to the original PMA submission. Although a PMA supplement applies to an approved PMA, in many cases there will be amendments to the PMA or to the PMA supplement before it is approved. In addition PMA reports may also have amendments if the applicant is requested to submit additional information on a report. That is,

A PMA supplement is the submission required for a change affecting the safety or effectiveness of the device for which the applicant has an approved PMA; additional information provided to FDA for PMA supplement under review are *amendments* to a supplement

A PMA amendment includes all additional submissions to a PMA or PMA supplement *before* approval of the PMA or PMA supplement OR all additional correspondence after PMA or PMA supplement approval.

Note: This terminology varies slightly for Investigational Device Exemption (IDE) submissions. An IDE supplement is any additional submission to an IDE *after* approval of the IDE. An IDE amendment is any additional submissions to an IDE *before* approval of the IDE.

[\[back to top\]](#)

### When to submit a PMA supplement (§814.39)

Changes that Require a PMA Supplement

After FDA has approved a PMA, an applicant must submit a PMA supplement for review and approval by FDA before making any change affecting the safety or effectiveness of the device unless FDA has advised that an alternate type of submission is permitted for a particular change. All changes must meet the requirements of the Quality System regulation (Good Manufacturing Practices) under 21 CFR Part 820 including the design control requirement under §20.30. Changes for which an applicant must submit a PMA supplement include, but are not limited to, the following types of changes if they affect the safety or effectiveness of the device:

- new indication for use of the device;
- labeling changes;
- the use of a different facility or establishment to manufacture, process, sterilize, or package the device;
- changes in manufacturing facilities, methods, or quality control procedures;
- changes in sterilization procedures;
- changes in packaging;
- changes in the performance or design specifications, circuits, components, ingredients, principles of operation, or physical layout of the device; and
- extension of the expiration date of the device based on data obtained under a new or revised stability or sterility testing protocol that has not been approved by FDA. [If the protocol has been previously approved by FDA, a supplement is not submitted but the change must be reported to FDA in the postapproval periodic reports as described in the §814.39(b).]

Additional guidance on when a PMA Supplement is required can be found in the following documents:

Modifications to Devices Subject to Premarket Approval - The PMA Supplement Decision Making Process:  
Draft only, not for implementation <http://www.fda.gov/cdrh/ode/pumasupp.pdf>

When PMA Supplements are Required, #P90-1  
<http://www.fda.gov/cdrh/p90-1.html>

Changes without a PMA Supplement 814.39(b)

An applicant may make a change in a device after FDA's approval of the PMA without submitting a PMA supplement if (1) the change does not affect the device's safety or effectiveness, and (2) the change is reported to FDA in a postapproval periodic report (annual report) required as a condition of approval of the device, e.g., an editorial change in labeling which does not affect the safety or effectiveness of the device. Trivial changes, such as changes in the color of a label, would not have to be included in the postapproval periodic report.

[\[back to top\]](#)

#### **Types of PMA Supplements**

The methods of notification and FDA involvement of changes to a PMA approved medical device depend on the type of

change made. A summary of the types of notification and FDA involvement is outlined below.

- **PMA supplement (180 days) - §814.39(a)**
  - for significant changes that affect the safety and effectiveness of the device
  - in-depth review and approval by FDA is required before implementation of the change
  - A full PMA review including a review by an outside advisory panel may be required. The criteria for a full PMA review includes changes in the device that may raise different types of safety and effectiveness questions or changes in which there may be no accepted test methods for evaluating the issues of safety or effectiveness. The criteria for taking supplements to the outside advisory panel for review are discussed in Criteria for Panel Review of PMA Supplements <http://www.fda.gov/cdrh/p863.html>

Some 180-day PMA supplements may be reviewed using the **Real-Time Review** process. In this process the supplement is reviewed during a meeting or conference call with the applicant. FDA will fax its decision to the applicant within five working days after the meeting or call. The change must meet certain criteria to be eligible for this type of review. Supplements with detailed clinical data are generally not considered for this program. The criteria and process for the Real Time Review program are outlined in "Real-Time" Review Program for Premarket Approval Application (PMA) Supplements. <http://www.fda.gov/cdrh/ode/realim2.html>

- **Special PMA Supplement -- Changes Being Effected - §814.39(d)**
  - for any change that enhances the safety of the device or the safety in the use of the device
  - may be placed into effect by the applicant prior to the receipt of a written FDA order approving the PMA supplement.

After FDA approves a PMA, any change described below that enhances the safety of the device or the safety in the use of the device [§814.39(d)(2)] may be placed into effect by the applicant prior to the receipt of a written FDA order approving the PMA supplement, but after the applicant receives specific acknowledgment that the application qualifies for review under §814.39(d)(2) provided that:

- the PMA supplement and its mailing cover are plainly marked "Special PMA Supplement -- Changes Being Effected";
- the PMA supplement provides a full explanation of the basis for the changes;
- the applicant has received acknowledgment that the application qualifies as a "Special PMA Supplement -- Changes Being Effected" from FDA for the supplement;
- the PMA supplement specifically identifies the date that such changes are being effected; and
- the change is made according to the good manufacturing practices regulation.

The following changes are permitted [§814.39(d)(1)]:

- labeling changes that add or strengthen a contraindication, warning, precaution, or information about an adverse reaction;
- labeling changes that add or strengthen an instruction that is intended to enhance the safe use of the device;
- labeling changes that delete misleading, false, or unsupported indications; and



- changes in quality controls or the manufacturing process that add a new specification or test method, or otherwise provide additional assurance of purity, identity, strength, or reliability of the device.

The applicant is encouraged to contact the PMA Staff to assist in determining if the change meets the requirements of §814.39(b).

- **30-day Notice and 135 PMA Supplement - §814.39(f)**
  - Used for modifications to manufacturing procedures or methods of manufacture that affect the safety and effectiveness of the device.
  - Changes in a manufacturing/sterilization site or to design or performance specifications do not qualify
  - If the change qualifies as a 30day Notice, the change may be made 30 days after FDA receives the 30day notice unless FDA informs the PMA holder that the 30-day Notice is not adequate and describes the additional information or action required. If the 30-day Notice was not adequate, but contained data meeting appropriate content requirements for a PMA supplement, then the 30-day Notice will become a 135-day PMA Supplement.

Additional guidance can be found in "30-Day Notices and 135-Day PMA Supplements for Manufacturing Method or Process Changes: Guidance for Industry and CDRH"

<http://www.fda.gov/cdrh/modact/daypmaasp.html>  
<http://www.fda.gov/cdrh/modact/daypmaasp.pdf>

Note: 30-day Notice is not the same as a 30-day Supplement. See below for information regarding the 30-day Supplement.

- **Express PMA Supplement for Facilities Change (formerly called Pilot PMA Supplement Program)**
  - For moving the manufacturing site if certain conditions apply.
  - Manufacturing site must have received a Quality System/GMP inspection within the last two years.
  - If requirements are not met, 180-day PMA Supplement must be submitted.
  - Additional information on the Express PMA Supplement process can be found in the guidance document "Draft Guidance: Likelihood of Facilities Inspections When Modifying Devices Subject to Premarket Approval" <http://www.fda.gov/cdrh/comp/likelihood.html>
- **Annual (periodic) Report or 30-day Supplements-§814.39(e)**
  - FDA may allow certain changes to be reported in an annual report or 30-day supplement instead of a PMA supplement submission. (If this method is utilized, FDA will typically request that the information be reported in the annual report and not as a 30-day supplement.)
  - FDA will notify applicants of this alternative through an advisory opinion to the affected industry or in correspondence with the applicant.

FDA will identify a change to a device for which the applicant has an approved PMA and for which a PMA supplement is not required under 814.39(a). FDA will identify such a change in an advisory opinion under §10.85, if the change applies to a generic type of device. Such changes will be identified in written correspondence to each PMA holder who may be affected by FDA's decision.

FDA will require that a change, for which a PMA supplement under §814.39(a) is not required, to be reported

to FDA in a periodic (annual) report or a 30-day PMA supplement. In written correspondence, FDA will identify the type of information that is to be included in the report or 30-day PMA supplement.

If FDA requires that the change be reported in a periodic report, the change may be made before it is reported to FDA. If FDA requires that the change be reported in a 30-day PMA supplement, the change may be made 30 days after FDA files the 30-day supplement, unless FDA informs the PMA holder that additional information is required, the supplement is not approvable, or the supplement is denied. The 30-day PMA supplement must follow the instructions in the correspondence or advisory opinion. Any 30-day PMA supplement that does not meet the requirements of the correspondence or advisory opinion will not be filed and, therefore, will not be deemed approved 30 days after receipt.

The applicant is encouraged to contact the PMA staff to assist in determining if the change meets the requirements of §814.39(e).

- **Document to file**
    - for changes that do not affect the safety or effectiveness of the device
    - very limited or no FDA involvement prior to implementation of the change
- Minor manufacturing changes and minor quality control changes can be documented to file. Examples of changes that can be documented to file include editorial changes to a Standard Operating Procedure (SOP) to make instructions clearer and combining two SOPs into one.
- **New PMA**
    - Certain changes may require the submission of a complete new PMA. If any of the following changes occur, the applicant should consult the appropriate reviewing branch in the Office of Device Evaluation if:
      - the design change causes a different intended use, mode of operation, and technological basis of operation,
      - there will be a change in the patient population that will be treated with the device, or
      - the design change is so significant that a new generation of the device will be developed.

[\[back to top\]](#)

#### **PMA Amendments (§ 814.37)**

An applicant may amend a pending PMA or PMA supplement to revise existing information or provide additional information. FDA may request that the applicant amend their PMA or PMA supplement with any necessary information about the device that FDA considers necessary to complete the review of the PMA or PMA supplement.

If the applicant submits a major PMA amendment on his or her own initiative or at FDA's request, the review period may be extended up to 180 days. A major amendment is one that contains significant new data from a previously unreported study, significant updated data from a previously reported study, detailed new analyses of previously submitted data, or significant required information previously omitted.

A PMA amendment must include the PMA or PMA supplement number assigned to the original submission and the reason

for submitting the amendment.

[\[back to top\]](#)

#### **Withdrawal and Resubmission (§ 814.37)**

Applicants may voluntarily withdraw their PMA or PMA supplement. If FDA requests an applicant to submit a PMA amendment, and a written response to FDA's request is not received within 180 days, FDA will consider the pending PMA supplement to be withdrawn voluntarily by the applicant (abandoned).

An applicant may resubmit a PMA or PMA supplement that was withdrawn, that FDA has refused to accept for filing, or that FDA has disapproved. A resubmitted PMA or PMA supplement must comply with the requirements of §814.20 or §814.39, respectively, and must include the PMA number assigned to the original submission as well as the applicant's reason for resubmission.

[\[back to top\]](#)

#### **Suggested Format For PMA Supplement Cover Letters**

An applicant's cover letter should accurately identify the type of PMA submission and include information needed for FDA tracking purposes. To expedite its processing, the following suggestions and formats have been prepared.

All procedures and actions that apply to a PMA application under §814.20 also apply to PMA supplements, except that the information required in a supplement is limited to that needed to support the change. A summary is required only if there are new indications for use of the device, significant changes in the performance or design specifications, circuits, components, ingredients, principles of operation, or physical layout of the device, or when otherwise required by FDA.

**Three copies** of a PMA supplement are required and must include information relevant to the proposed changes in the device. A PMA supplement must include a separate section that identifies each change for which approval is being requested and explains the reason for each change. The applicant must submit additional copies and information if requested by FDA. The timeframes for review of a PMA supplement are the same as those provided for a PMA (§814.40).

PMA supplements and amendments should be mailed to the following address:

Food and Drug Administration  
Center for Devices and Radiological Health  
Document Mail Center (HFZ-401)  
9200 Corporate Blvd.  
Rockville, MD 20850

General Suggestions

- Use the applicant's letterhead or that of the applicant's authorized representative.
- Address the cover letter as indicated under "PMA Supplement Cover Letter" below. To minimize misrouting, do not include an FDA staff member's name in the address.
- If submitted by someone other than the applicant (e.g., lawyer or consultant), the identity of the applicant must be included.
- In the case of a PMA supplement for a new model or revised indication, specify the indication for use for which FDA approval is requested.
- If applicable, include the reference numbers for any Premarket Notification, Investigational Device Exemption, reclassification petition, or color, additive petition submitted by the applicant.
- Indicate whether the submission includes an environmental assessment. Please note that an environmental assessment is typically not required. See Chapter 3 of the PMA Manual, "Environmental Impact Considerations," for additional guidance.  
[http://www.fda.gov/cdrm/dsma/pmanan/sec03.html#P1127\\_59655](http://www.fda.gov/cdrm/dsma/pmanan/sec03.html#P1127_59655)
- In the case of a PMA supplement, specify the location of the following information required by 21 CFR 814.39(c): identification of each change for which approval is requested and an explanation of the reason for each change.
- In the case of a "Special PMA Supplement - Changes Being Effected" under 21 CFR 814.39(d), identify the submission as such, provide a full explanation of the basis for the changes and identify the date that such changes are being effected.
- In the case of a 30-day PMA supplement under 21 CFR 814.39(e), specify the date of the FDA advisory opinion or correspondence providing for the change(s) to be reported in this manner and identify the submission as specified in the FDA advisory opinion or correspondence. In the cover letter for the 30-day supplement, provide a statement that confirms only changes identified in the advisory opinion or previous FDA correspondence are being requested via the supplement.
- Date and sign the cover letter and include a copy in the first volume of each copy of the PMA submission.

#### Suggested Formats

To minimize delays in processing of PMA submissions, it is important that the applicant's cover letter correctly identify the type of submission, i.e., a PMA supplement, an amendment to a pending PMA or PMA supplement, or a required periodic report to an approved original PMA, PMA supplement or report amendment. Although FDA correspondence requesting additional information or approving a PMA submission identifies the form in which a subsequent submission is to be made, the incidence of incorrectly identified submissions has been significant. Delays in FDA processing occur when a document is misidentified and the submission must be reprocessed.

The general full format of the cover letter for a PMA supplement appears below. Only the subject section and opening sentence(s) are provided for the various types of PMA supplement submissions. In several instances, alternative opening statements are included to address specific situations.

#### PMA Supplement Cover Letter

[Date]

Food and Drug Administration  
Center for Devices and Radiological Health  
Document Mail Center (HFZ-401)  
9200 Corporate Blvd.  
Rockville, MD 20850

SUBJECT: PMA Supplement to [original PMA reference number] for [new device trade name or present device trade name if not being revised as a result of the modification]

To Whom It May Concern:

[Applicant's name] is submitting this supplement to our approved Premarket Approval application for the [present device trade name] to request approval to [identify the changes or modifications to be made in the device].

If the supplement involves a new manufacturing or sterilization facility, indicate whether the facility is prepared for an FDA inspection. If not prepared, provide the expected date when the facility will be ready for inspection.]

If another document is incorporated by reference, e.g., a master file, please include the original letter of authorization as an attachment to this cover letter.

The existence of this PMA supplement and the data and other information that it contains are confidential, and the protection afforded to such confidential information by 18 USC 1905, 21 USC 331(i), 5 USC 552, and other applicable laws is hereby claimed. [Note: confidentiality claims cannot be made unless the applicant has complied with the applicable requirements.

If there are questions regarding this submission, [name] may be contacted at [give telephone number including area code].

Sincerely yours,

[Signature]  
[Name and title of applicant's representative]

**"Special PMA Supplement - Changes Being Effectuated" Cover Letter**

SUBJECT: Special PMA Supplement-Changes Being Effectuated" to [original PMA reference number] for [present device trade name]

[Applicant's name] is submitting this "Special PMA Supplement-Changes Being Effectuated" to our approved Premarket Approval application to place into effect the following change(s) described in 21 CFR 814.39(d)(2) that enhance(s) the [safety of/safety in the use] of [device trade name].

[As required by 21 CFR 814.39(d)(1), provide a full explanation of the basis for the changes and the date that such changes are being effectuated.]

**30-day Notice PMA Supplement Cover Letter**

SUBJECT: 30-day Notice PMA supplement to [original PMA reference number] for [present device trade name]

[Applicant's name] is submitting this 30-day Notice PMA supplement to our approved Premarket Approval application for the [present device trade name] to request approval to [identify the manufacturing change or modification to be made in the device].

Note: Two copies should be sent to CDRH's Office of Device Evaluation. At the same time, a duplicate copy should be sent directly to CDRH's Office of Compliance, Field Programs Branch, HFZ-306, ATTN: 30-day Notice, 9200 Corporate Blvd., Rockville, MD 20850. The duplicate copy should be flagged: "Office of Compliance Copy."

**Express PMA Supplement Cover Letter**

SUBJECT: Express PMA supplement to [original PMA reference number] for [present device trade name]

[Applicant's name] is submitting this Express PMA supplement to our approved Premarket Approval application for the [present device trade name] to request approval for a new [manufacturing or sterilization] facility.

Note: Two copies should be sent to CDRH's Office of Device Evaluation. At the same time, a duplicate copy should be sent directly to CDRH's Office of Compliance, Field Programs Branch, HFZ-306, 9200 Corporate Blvd., Rockville, MD 20850. The duplicate copy should be flagged: "Office of Compliance Copy."

**30-day PMA Supplement Cover Letter**

SUBJECT: 30-day PMA supplement to [original PMA reference number] for [present device trade name]

[Applicant's name] is submitting this 30-day PMA supplement to our approved Premarket Approval application for the [present device trade name] to request approval to [identify the change or modification to be made in the device]. As provided in the FDA [letter/advisory opinion] dated [date], this change may be reported to FDA in a 30-day PMA supplement and implemented 30 days after FDA files the 30-day PMA supplement under the

conditions described in 21 CFR 814.39(e).

**Amendment to Original PMA or PMA Supplement Cover Letter**

SUBJECT: Amendment to [original PMA or PMA supplement reference number] for [device trade name]

**Unsolicited submission of additional information**

[Applicant's name] is submitting this amendment to its [Premarket Approval application or PMA supplement] [original PMA or PMA supplement reference number] for the [device trade name] to provide [identify the additional information being provided].

[back to top]

**References**

[21 CFR 814.37](#)  
[21 CFR 814.39](#)

When PMA Supplements are Required, #P90-1 (blue book memo)  
<http://www.fda.gov/cdrh/p90-1.html>

Modifications to Devices Subject to Premarket Approval - The PMA Supplement Decision Making Process; Draft  
<http://www.fda.gov/cdrh/ode/pumasupp.pdf>

Criteria for Panel Review of PMA Supplements #P86-3 (blue book memo)  
<http://www.fda.gov/cdrh/p863.html>

Real-Time Review Program for Premarket Approval Application (PMA) Supplements  
<http://www.fda.gov/cdrh/ode/realtime2.html>  
<http://www.fda.gov/cdrh/ode/realtime.pdf>

30-Day Notices and 135-day PMA Supplements for Manufacturing Method or Process Changes, Guidance for Industry and CDRH (Docket 98D-0080); Final  
<http://www.fda.gov/cdrh/modact/daypmasp.html>  
<http://www.fda.gov/cdrh/modact/daypmasp.pdf>

Draft Guidance: Likelihood of Facilities Inspections When Modifying Devices Subject to Premarket Approval  
<http://www.fda.gov/cdrh/comp/likelihood.html>

Guidance to Industry Supplements to Approved Applications for Class III Medical Devices: Use of Published Literature, Use

of Previously Submitted Materials, and Priority Review; Final  
<http://www.fda.gov/cdrh/modact/evidence.html>

[\[back to top\]](#)

Updated 6/11/2003

Choose another topic:



Accessibility



Disclaimer



**The Least Burdensome  
Provisions of the FDA  
Modernization Act of 1997:  
Concept and Principles; Final  
Guidance for FDA and Industry**

**Document Issued on: October 4, 2002**



**U.S. Department of Health and Human Services  
Food and Drug Administration  
Center for Devices and Radiological Health  
Office of Device Evaluation  
Center for Biologics Evaluation and Research**

## Preface

### Public Comment:

Comments and suggestions may be submitted at any time for Agency consideration to Dockets Management Branch, Division of Management Systems and Policy, Office of Human Resources and Management Services, Food and Drug Administration, 5630 Fishers Lane, Room 1061, (HFA-305), Rockville, MD 20852. When submitting comments, please refer to Docket No. 01D-0202. Comments may not be acted upon by the Agency until the document is next revised or updated.

For questions regarding the use or interpretation of this guidance, contact Joanne R. Less, Ph.D. (CDRH) at (301) 594-1190 or by email at [jrl@cdrh.fda.gov](mailto:jrl@cdrh.fda.gov) or Leonard Wilson (CBER) at (301) 827-0373 or by email at [wilsonl@cber.fda.gov](mailto:wilsonl@cber.fda.gov).

### Additional Copies:

Additional copies are available from the Internet at: <http://www.fda.gov/cdrh/ode/guidance/1332.pdf>, or CDRH Facts-On-Demand. In order to receive this document via your fax machine, call the CDRH Facts-On-Demand system at 800-899-0381 or 301-827-0111 from a touch-tone telephone. Press 1 to enter the system. At the second voice prompt, press 1 to order a document. Enter the document number 1332 followed by the pound sign (#). Follow the remaining voice prompts to complete your request.

## Foreword

While the Agency received very few comments on the draft guidance, almost all of them strongly supported the guidance and encouraged its full implementation as soon as possible. Several comments included recommendations for the Agency. Several comments recommended that FDA develop a training program for its staff on the least burdensome principles. Comments also suggested that FDA develop ways to assess both the Agency's success in implementing the principles and stakeholders' satisfaction with FDA's incorporation of them into its daily activities.

The Agency agrees with these recommendations. Although initial training already has been conducted for staff within the Center for Devices and Radiological Health (CDRH), the Center for Biologics Evaluation and Research (CBER), and for the device advisory panels, additional in-depth training sessions will be held to ensure that the least burdensome approach is fully incorporated into the two centers' work. FDA is also in the process of developing tools to be used by both Agency staff and its stakeholders to periodically assess the implementation of the least burdensome principles. Some measurement tools have been developed, such as the checklists to be used following the FDAMA early collaboration meetings. These checklists will help assess if the least burdensome approach was used to determine the type of valid scientific evidence needed to support marketing approval and if such an approach was used to design any needed clinical trial. FDA is taking this opportunity to encourage its stakeholders to use these assessment tools. Additional tools of this type are needed to accurately assess the Agency's incorporation of the least burdensome principles into its various regulatory activities. Tools are also needed to assess the impact of the least burdensome approach on expediting the development of new medical technologies. The Agency will work with its stakeholders to develop these important measuring tools. The Agency encourages your thoughtful evaluation of its efforts to determine whether the least burdensome approach is being successfully implemented and to accurately assess its impact on the public health.

**TABLE OF CONTENTS**

<b>I.</b>	<b>Background .....</b>	<b>1</b>
<b>II.</b>	<b>What does “Least Burdensome” Mean? .....</b>	<b>2</b>
<b>III.</b>	<b>What Basic Principles Underlie the Least Burdensome Concept? .....</b>	<b>3</b>
<b>IV.</b>	<b>How do the Least Burdensome Principles Apply to PMAs (Originals and..... Supplements)?</b>	<b>3</b>
<b>V.</b>	<b>How do the Least Burdensome Principles Apply to 510(k)s?.....</b>	<b>5</b>
<b>VI.</b>	<b>What are Some General Applications of the Least Burdensome Principles?.....</b>	<b>6</b>
<b>VII.</b>	<b>Conclusion .....</b>	<b>7</b>
<b>VIII.</b>	<b>Hyperlinks.....</b>	<b>9</b>

## The Least Burdensome Provisions of the FDA Modernization Act of 1997: Concept and Principles; Final Guidance for FDA and Industry

This document is intended to provide guidance. It represents the Agency's current thinking on this topic. It does not create or confer any rights for or on any person and does not operate to bind the Food and Drug Administration (FDA) or the public. An alternative approach may be used if such approach satisfies the requirements of the applicable statute and regulations.

### I. Background

A central purpose of the Food and Drug Administration Modernization Act of 1997 (FDAMA) is "to ensure the timely availability of safe and effective new products that will benefit the public and to ensure that our Nation continues to lead the world in new product innovation and development."<sup>1</sup> As can be seen in this statement, Congress' goal was to streamline the regulatory process (i.e., reduce burden) to improve patient access to breakthrough technologies. While Congress wanted to reduce unnecessary burdens associated with the premarket clearance and approval processes, Congress did not lower the statutory criteria for demonstrating substantial equivalence or reasonable assurance of safety and effectiveness.

To help achieve this goal, Congress added sections 513(i)(1)(D) and 513(a)(3)(D)(ii) to the Federal Food, Drug, and Cosmetic Act (the act). These provisions capture both of the ideas expressed in the legislative history: FDA should eliminate unnecessary burdens that may delay the marketing of beneficial new products, but the statutory requirements for clearance and approval remain unchanged.

Specifically, section 513(i)(1)(D) states, "Whenever the Secretary requests information to demonstrate that devices with differing technological characteristics are substantially equivalent, the Secretary shall only request information that is necessary to making substantial equivalence determinations. In making such a request, the Secretary shall consider the least burdensome means of demonstrating substantial equivalence and request information accordingly." Section 513(a)(3)(D)(ii) states that, "Any clinical data, including one or more well-controlled investigations, specified in writing by the Secretary for demonstrating a reasonable assurance of device effectiveness shall be specified as a result of a determination by the Secretary that such data are necessary to establish device effectiveness. The Secretary shall consider, in consultation with the applicant, the least burdensome appropriate means of evaluating device effectiveness that would have a reasonable likelihood of resulting in approval."

These two sections of the law contain what are commonly referred to as the "least burdensome

<sup>1</sup> Senate Report No. 105-43 (1997).

provisions” of the act. Over the last few years, FDA has been working to develop an interpretation of the least burdensome provisions that would accurately capture Congress’ intent and that could be implemented consistently by the Agency and industry. This guidance is one part of that process. As presented below, FDA believes the least burdensome concept to be one that could affect almost all premarket regulatory activities, including presubmission meetings with industry, premarket submissions, and the development of guidance documents and regulations. The Agency believes that this interpretation most accurately reflects the spirit of the new law.

In order for the least burdensome approach to be successful, it is important that industry continue to meet all of its statutory and regulatory obligations, including preparation of appropriate, scientifically sound data to support applications. It is also important that FDA continue to enforce the statutory and regulatory provisions that are in place to protect the public after a device reaches the market. The confidence that the American public and the global market have placed in FDA regulation relies on inspections, surveillance, and reporting activities as much as on premarket review. If FDA becomes aware of information unrelated to the clearance or approval decision, but which could represent noncompliance with the law or implementing regulations, such issues cannot be ignored. While the Agency will not withhold the clearance or approval of a device because of an issue unrelated to a premarket decision, it is the Agency’s responsibility to act on such information in the postmarket period and take whatever regulatory or enforcement action is appropriate.

Finally, although the least burdensome provisions are recent additions to the statute, there are cases predating FDAMA that illustrate how the Agency has utilized a least burdensome approach in resolving a regulatory issue or in helping industry to bring a new device to market. In fact, several examples of situations in which CDRH used a least burdensome approach are presented in this guidance. FDA recognizes, however, that by adding these provisions to the act, Congress was directing the Agency to implement this type of approach in a consistent and uniform manner to encourage the timely development of new medical device technologies. FDA believes that this guidance, in combination with other guidances that have been developed as a part of the least burdensome effort, will help to ensure that the Agency accomplishes this goal.

## II. What does “Least Burdensome” Mean?

We are defining the term “least burdensome” as a **successful means of addressing a premarket issue that involves the most appropriate investment of time, effort, and resources on the part of industry and FDA**. This concept applies to all devices and device components of combination products regulated by FDA under the device provisions (including *in vitro* diagnostics (IVDs)). When conscientiously applied, we believe the least burdensome concept will help to expedite the availability of new device technologies without compromising scientific integrity in the decision-making process or FDA’s ability to protect the public health. The least burdensome concept should be integrated into all premarket activities, as well as postmarket activities as they relate to the premarket arena. These activities include:

- Simple inquiries regarding device development
- Pre-submission activities, including early collaboration meetings and the pre-IDE process

- Premarket submissions
- Panel review and recommendations
- Post-approval studies
- Reclassification petitions
- Guidance document development and application
- Regulation development

### **III. What Basic Principles Underlie the Least Burdensome Concept?**

FDAMA did not change the statutory threshold for premarket clearance or approval. To continue to meet this standard, while also fulfilling the intent of the least burdensome provisions of FDAMA, we intend to apply the following basic principles:

- The basis for all regulatory decisions will be found in sound science and the spirit and the letter of the law;
- Information unrelated to the regulatory decision should not be part of the decision-making process;
- Alternative approaches to regulatory issues should be considered to optimize the time, effort, and resources involved in resolving the issue consistent with the law and regulations; and
- All reasonable measures should be used to reduce review times and render regulatory decisions within statutory timeframes.

### **IV. How do the Least Burdensome Principles Apply to PMAs (Originals and Supplements)?**

FDA and industry should focus on the statutory criteria for approval of the PMA, i.e., the determination of reasonable assurance of safety and effectiveness, as defined in the regulations (21 CFR 860.7). This determination should be based on valid scientific evidence, and information unrelated to the premarket approval decision should not be submitted to, nor requested by, the Agency. [Hyperlink #1](#)

Most original PMAs and some supplements require clinical data in order to meet the statutory threshold for approval. Where clinical outcome can be reliably predicted from non-clinical data, however, well-designed bench and/or animal testing can be the basis for approval of the PMA. Conditions where such non-clinical data could meet the threshold for approval typically involve devices or modifications of approved devices for which scientifically valid information is available in the public domain. If clinical data are needed, FDA and industry should consider alternatives to randomized, controlled clinical trials when potential bias associated with alternative controls can be addressed.

Given the above, alternatives to randomized, controlled clinical trials may include:

- Reliance on valid<sup>2</sup> non-U.S. data (where appropriate for the intended U.S. patient population),
- “Paper PMAs,”<sup>3</sup> or
- Study designs employing non-concurrent controls, such as historical controls (e.g., literature, patient records), objective performance criteria (OPC)<sup>4</sup>, and patients as their own control. [Hyperlink #3](#)

In addition, when clinical data are needed for PMA approval, the use of scientifically valid surrogate endpoints ([Hyperlink #4a](#)) and statistical methods, such as Bayesian analyses,<sup>5</sup> should be considered to determine if they may be appropriately used. If incorporated as part of the study design, early submission of the application may also be considered, as appropriate. [Hyperlink #4b](#)

Whenever possible, FDA and industry decisions about device development and review should rely on information that is available from earlier versions of the same device or from marketing experience with similar devices. Recognizing that devices often develop incrementally, earlier generations of a product line may provide important information that can reduce the need for, or the amount of, new additional data. Therefore, information gathered throughout a product’s life cycle may also help reduce submission data requirements.

The role of postmarketing information should be considered in determining the appropriate type and amount of data that should be collected in the premarket setting to support PMA approval. Postmarketing information should also be considered for assuring long-term device safety and effectiveness, wherever appropriate. Discussions regarding the premarket/postmarket balance should occur early in the device development process with the understanding that the statutory criterion for approval continues to be reasonable assurance of safety and effectiveness. [Hyperlink #5](#)

The effective use of FDA-recognized standards can streamline PMA submissions and provide for a more efficient review process. Declarations of conformity to these standards should be submitted whenever possible. [Hyperlink #6](#)

---

<sup>2</sup> 21 CFR 814.15(b) indicates that for FDA to accept studies conducted outside the U.S. in support of a PMA, the data must be “valid.”

<sup>3</sup> A “paper PMA” is one that is based on bench testing and/or information derived from peer-reviewed scientific literature. For example, a paper PMA may rely on a meta-analysis of information derived from the literature. [Hyperlink #2](#)

<sup>4</sup> “Objective performance criteria” are performance criteria based on broad sets of data from historical databases (e.g., literature or registries) that are generally recognized as acceptable values. These criteria may be used for surrogate or clinical endpoints in demonstrating the safety or effectiveness of a device.

<sup>5</sup> Modern statistical methods may also play an important role in achieving a least burdensome path to market. For example, through the use of Bayesian analyses, studies can be combined in order to help reduce the sample size needed for the experimental and/or control device.



**V. How do the Least Burdensome Principles Apply to 510(k)s?**

FDA and industry should focus on those issues that can affect the substantial equivalence (SE) determination, that is, whether the device has the same intended use as the predicate device and is as safe and effective as a legally marketed device. Information unrelated to the substantial equivalence decision should not be submitted to, nor requested by, the Agency. [Hyperlink #7](#)

In assessing the intended use of the device for purposes of the SE determination, labeling should be reviewed to ensure that the necessary elements identified in 21 CFR 807. 87(e) are provided. Ensuring compliance with other regulations (e.g., 21 CFR Parts 801 (except for 801.6), 809, 820) should not ordinarily be part of the SE determination. [Hyperlink #8](#)

In making the SE determination, the Agency should reaffirm its longstanding review policy<sup>6</sup> that:

- (1) Substantial equivalence will normally be determined based on comparative device descriptions, including performance characteristics; and
- (2) Performance testing should be submitted if there are important descriptive differences between the device and other devices of the same type or the descriptive characteristics for the new device are not precise enough to assure comparability. In these instances, the most appropriate bench and/or animal testing, or in the case of IVDs, analytical testing (i.e., precision, accuracy, limit of detection, cross-reactivity, and effects of interfering substances, and clinical sensitivity/specificity), to address the performance issue should be provided. Summary information regarding the testing should generally suffice, but the test protocol, description of test methods, or any standards followed in conducting the testing should also be provided.

Clinical data are not required for most 510(k)s. Consequently, the Agency should clearly document the issue that warrants a request for such data. In deciding how the clinical data should be obtained, FDA and industry should consider alternatives to randomized, controlled clinical trials, as discussed above for PMAs, when potential bias associated with alternative controls can be addressed. Alternatives such as reliance on valid<sup>2</sup> non-U.S. data (where appropriate for the intended U.S. patient population), use of meta-analyses, and trial designs employing non-current controls such as historical controls (e.g., literature, patient records), OPC, and patients as their own control should be considered to determine if they may be appropriately used. In addition, the use of scientifically valid surrogate endpoints should be considered as discussed above for PMAs. [Hyperlink #9](#)

In accordance with the guidance document entitled, “Guidance for Industry and FDA Staff – Use of Standards in Substantial Equivalence Determinations,”<sup>7</sup> industry should submit and FDA should rely on a manufacturer’s: 1) statement that a device will meet a recognized standard or 2) a declaration of conformity to a standard, as appropriate. [Hyperlink #10](#)

<sup>6</sup> “Guidance on the Center for Devices and Radiological Health’s Premarket Notification Review Program.” June 30, 1986. ([www.fda.gov/cdrh/k863.html](http://www.fda.gov/cdrh/k863.html))

<sup>7</sup> This guidance is available on the web at: [www.fda.gov/cdrh/ode/guidance/1131.html](http://www.fda.gov/cdrh/ode/guidance/1131.html)

Manufacturers may make modifications to a cleared device that do not require submission of a new 510(k). Given this, FDA should not request information regarding changes observed in a new 510(k) that were previously implemented by industry without the requirement for 510(k) clearance, unless the lack of information regarding the previous modification(s) does not allow the SE determination to be made. [Hyperlink #11](#)

Manufacturing and quality control information should not be part of a 510(k) submission unless the information relates to the substantial equivalence determination. [Hyperlink #12](#)

#### **VI. What are Some General Applications of the Least Burdensome Principles?**

FDA and industry should utilize a *Systems Approach*<sup>8</sup> to device regulation and take full advantage of all regulatory tools available through FDAMA and reengineering, such as the *de novo* risk-based classification process and “*The New 510(k) Paradigm*.” [Hyperlink #13](#) The reclassification and exemption processes should also be used to ensure that the proper level of regulatory control is applied to a device type. [Hyperlink #14](#)

Reliance on postmarket controls (e.g., compliance with the Quality Systems (QS) regulation, postmarket surveillance, and the Medical Device Reporting requirements) should be considered as a mechanism to reduce the premarket burden for 510(k)s and PMAs, while still ensuring the safety and effectiveness of the device. [Hyperlink #15](#)

FDA and industry should make effective use of well-designed bench and/or animal testing. When non-clinical testing is being conducted or requested, the testing should be designed to address a specific question, use standards or standardized test methods whenever possible, employ scientifically relevant end-points, and use an appropriate bench and/or animal model. [Hyperlink #16](#)

Industry should incorporate by reference other premarket submissions (e.g., IDEs, 510(k)s, PMAs), whenever possible. FDA should encourage and accept this practice as a means of saving resources. [Hyperlink #17](#)

FDA should avoid using premarket review to ensure compliance with FDA statutes or regulations unrelated to the regulatory decision (e.g., Radiation Control for Health and Safety Act (RCHSA)). Similarly, verifying compliance with laws and regulations administered by other federal agencies (e.g., Occupational Safety and Health Administration (OSHA)) should not generally be part of the substantial equivalence or approval decision. [Hyperlink #18](#)

When requesting additional information to resolve a regulatory issue, FDA should:

- Identify the specific issue or question that the request is attempting to address;
- Acknowledge the information that was submitted and explain why it is deficient;

<sup>8</sup> “A Systems Approach to Premarket Review” can be found at: [www.fda.gov/cdrh/ode/guidance/prerevapproach.html](http://www.fda.gov/cdrh/ode/guidance/prerevapproach.html)

- Establish the relevance of the request to the determination that is being made, i.e., substantial equivalence or reasonable assurance of safety and effectiveness; and
- Remain open-minded to alternate ways to address the issue or question. [Hyperlink #19](#)

In responding to FDA's request for additional information, industry should make every attempt to respond completely and promptly. The response should:

- State the Agency's issue, and
- Provide one of the following:
  - the information requested, or
  - an explanation of why the issue is not relevant to determining substantial equivalence or reasonable assurance of safety and effectiveness, or
  - alternative information and an explanation of why the information adequately addresses the issue. [Hyperlink #19](#)

Whenever possible, FDA and industry should attempt to resolve minor questions/issues by phone, fax, or e-mail. The Agency should use deficiency letters to resolve the more complicated issues (i.e., major deficiencies) and include only those minor deficiencies that have not been adequately addressed by phone, fax, or e-mail. Industry should promptly respond to questions regarding minor deficiencies to avoid unnecessarily prolonging the review time. For both major and minor deficiencies, agreement between FDA staff and industry on a timeframe for responding to the deficiencies may help expedite the process. When FDA receives the additional information, the Agency should determine the relevancy and adequacy of the information to the SE or approval decision. Similarly, if industry proposes an alternative approach to resolving a regulatory issue, FDA should consider the appropriateness of the proposed alternative and, if appropriate, discuss it with industry.

If industry believes that the Agency did not use the least burdensome approach in attempting to resolve a regulatory issue, there are several avenues available to address this concern. In addition to the longstanding mechanisms available through supervisory oversight, CDRH has appointed a Center ombudsman who is also available as a resource to help resolve least burdensome issues.<sup>9</sup>

The least burdensome principles should also be applied in the development of guidance documents and regulations. [Hyperlink #20a](#); [Hyperlink #20b](#)

## VII. Conclusion

In order to achieve Congress' goal to "ensure that the FDA is an agency committed to fostering innovation and ensuring timely public access to beneficial new products,"<sup>10</sup> a least burdensome approach should be used in almost all regulatory activities. Application of the least burdensome principles to premarket requirements will help to reduce regulatory burden and save Agency and

<sup>9</sup> "A Suggested Approach to Resolving Least Burdensome Issues" can be found at: [www.fda.gov/cdrh/ode/guidance/1188.html](http://www.fda.gov/cdrh/ode/guidance/1188.html)

<sup>10</sup> Senate Report No. 105-43 (1997).

industry resources, while protecting the public health by maintaining the safety and effectiveness of medical devices. Full implementation of the least burdensome provisions of FDAMA is critical to, but only a part of, achieving Congress' intent in passing the new law. The Center's recent reengineering efforts and utilization of all regulatory mechanisms provided by the law, the implementing regulations, and Agency policies are also important steps toward achieving this goal.

## VIII. Hyperlinks

### Hyperlink #1

As defined in Section 515 of the act, the criteria for approval of a PMA is “reasonable assurance that a device is safe and effective under the conditions of use prescribed, recommended, or suggested in the proposed labeling.”

**Reasonable assurance of safety** is defined in 21 CFR 860.7(d)(1) as “There is reasonable assurance that a device is safe when it can be determined, based upon valid scientific evidence, that the probable benefits to health from use of the device for its intended uses and conditions of use, when accompanied by adequate directions and warnings against unsafe use, outweigh any probable risks.”

**Reasonable assurance of effectiveness** is defined in 21 CFR 860.7(e)(1) as “There is reasonable assurance that a device is effective when it can be determined, based upon valid scientific evidence, that in a significant portion of the target population, the use of the device for its intended uses and conditions of use, when accompanied by adequate directions for use and warnings against unsafe use, will provide clinically significant results.”

**Valid Scientific Evidence** is evidence from well-controlled investigations, partially controlled studies, studies and objective trials without matched controls, well-documented case histories conducted by qualified experts, and reports of significant human experience with a marketed device, from which it can fairly and responsibly be concluded by qualified experts that there is reasonable assurance of the safety and effectiveness of a device under its conditions of use. The evidence required may vary according to the characteristics of the device, its conditions of use, the existence and adequacy of warnings and other restrictions, and the extent of experience with its use.” (21 CFR 860.7(c)(2))

In accordance with the least burdensome principles, information that should not be factored into the premarket approval decision should not be submitted to, or requested by, the Agency. General examples of such information include the results of consumer preference testing and cost-effectiveness studies. As a specific example, consider the issue of electromagnetic compatibility (EMC). In the early 1990’s, CDRH was just becoming aware of the issue of electronic interference with medical devices. Recognizing the tendency to ask industry to address the issue of EMC in PMAs, the Center issued guidance<sup>11</sup> to the review staff on the proper way to approach EMC. This guidance stated that individual approval decisions should not be withheld based on EMC concerns unless reviewers had a basis to believe there were actual safety concerns related to that particular device. Therefore, in situations where a new issue surfaces that affects all devices of a particular type, FDA should address the issue with all manufacturers of that device type rather than hold up a specific application.

---

<sup>11</sup>“Electromagnetic Compatibility for Medical Devices: Issues and Solutions” can be found at: [www.fda.gov/cdrh/ode/639.pdf](http://www.fda.gov/cdrh/ode/639.pdf)

**Hyperlink #2**

To help determine how successful a particular body of literature will be in supporting the clearance/approval of a new device, the relevancy of the literature and the adequacy of the study design should be assessed. Questions such as those listed below should be considered in making this assessment:

- Is the device in the literature of comparable technology to the device under consideration for clearance/approval?
- Was the device in the literature intended to provide the same diagnostic or therapeutic intervention? For the same disease/condition? For the same patient population?
- Was the device used in a patient population that adequately represents the target population for the new device?
- Does the literature contain an adequate description of the protocol/procedures, including details of device use, follow-up, and safety and effectiveness endpoints for the stated indication?
- Is the patient accounting information in the literature sufficient to determine how the device performed?

Finally, when deciding if an article could be used to support marketing a new device, FDA and industry should consider contacting the author(s) of the research for additional information. For example, the study methods described in the literature are often very concise and do not include important details, such as the randomization method. Additional information about the study from the author(s) may provide details that strengthen the likelihood that the literature may be used to support the marketing application.

**Hyperlink #3**

Most original PMAs and some supplements require clinical data in order to meet the statutory threshold for approval. Where clinical outcome can be reliably predicted from non-clinical data, however, well-designed bench and/or animal testing can be the basis for approval of the PMA. Conditions where such non-clinical data could meet the threshold for approval typically involve devices or modifications of approved devices for which scientifically valid information is available in the public domain.

If clinical data are needed, FDA and industry should consider alternatives to a randomized, controlled trial (RCT) when potential bias associated with alternative controls can be addressed. While alternatives to a randomized, controlled trial should be considered, industry should not assume that an RCT would always be more costly in terms of both time and money. Industry should be aware that, in general, smaller sample sizes and less elaborate statistical analyses are needed for RCTs than for alternative trial designs. A major advantage of the RCT design is the assurance that confounding factors, such as selection biases, are minimized by the randomization, thus facilitating a more timely review of the data.

For some diseases/conditions, however, alternative study designs to traditional RCTs may be appropriate. For example, if there is no satisfactory intervention for the disease/condition being

studied or if only a limited number of patients are available to be studied, sponsors may consider a cross-over design or a design in which patients serve as their own baseline control. In other cases, validated objective outcomes or historical information from the literature may be available to allow for studies without a concurrent control. Finally, if an RCT is used, randomizing more often to the experimental device than the control therapy can reduce the burden of an RCT. Given the unique aspects often presented by device clinical studies, industry and FDA should consider all available options to ensure that the most appropriate, but also the least burdensome, approach is used.

Below are some examples of when a PMA supplement or an original PMA were approved using alternatives to RCTs as the least burdensome approach:

**PMA Supplements**

Modifications to the arrhythmia detection algorithm for an approved implantable cardioverter defibrillator were proposed to allow the device to discriminate between atrial and ventricular arrhythmias. Because it was determined that bench testing would allow a more thorough analysis of the change than a clinical trial, bench testing using pre-recorded human heart ECGs and an observational post-approval study were used to support approval of the PMA supplement.

A PMA was approved for a pneumatic ventricular assist device (VAD). The company wished to modify the device to be electrically controlled. CDRH relied primarily on bench testing to demonstrate that the flow pattern and cardiac index remained unchanged. Limited clinical data were collected to confirm that the type and frequency of adverse events were also unchanged.

CDRH approved modifications to a thermal ablation device, including hardware, software, and operational system changes, based on laboratory data and an engineering design analysis.

**Original PMAs**

Patient registries and literature were used to support the approval of a PMA for a bone cement for fixation of a hip prosthesis. Similarly, several orthopedic implants (constrained acetabular liner and cemented finger joint) were approved using data in the literature. Recently, CDRH relied on literature for its approval of a spinal cord stimulator to aid in the management of chronic intractable pain of the trunk and/or limbs.

PMAs for a cochlear implant and a sacral nerve stimulator for urinary incontinence were approved using studies in which the patients served as their own control.

A “paper” PMA was approved for a contact lens. Clinical data reported in the Japanese literature were used to support the application.

**Hyperlink #4a**

Scientifically valid surrogate endpoints should be used whenever appropriate to reduce the premarket burden. This type of endpoint is used routinely for many implanted devices, such as

orthopedic prostheses, implantable cardioverter defibrillators, stents, and vascular grafts. Almost all approvals of these types of implants are based on short-term (1 or 2 year) data as a predictor for long-term experience. Another specific example when CDRH has relied on scientifically valid surrogate endpoints is the PMA for digital mammography. To expedite the availability of this new imaging modality, CDRH relied on sensitivity and specificity detection measurements of the presence/absence of breast cancer as surrogate endpoints for the new device rather than using the clinical endpoint of the reduction in mortality due to breast cancer. Presuming that the detection of breast cancer has clinical benefit even if it is not directly linked to a reduction in mortality allowed the clinical trial to be conducted in a least burdensome manner while still ensuring that the statutory threshold for approval was met.

As another example of the use of surrogates, consider the approval of a low density lipoprotein (LDL) column. This column was approved for patients with certain risk factors based on high LDL levels. For this device, the reduction of the cholesterol level was used as a surrogate for reducing the risk of atherosclerotic complications. For IVDs, surrogates have been used in clinical studies of tumor markers for the early detection of cancer as well as in studies of cardiac markers, such as troponin I and T analytes. Another example is the use of spinal flexion and extension, as viewed on plain film x-rays, as surrogate endpoints for fusion in studies of spinal cages.

#### **Hyperlink #4b**

Under certain predetermined conditions, a PMA may be submitted before all of the patients are followed according to the investigational plan. For example, if the statistical analysis includes an interim analysis with predetermined criteria for stopping the study, the application may be submitted early if the analysis demonstrates that the criteria were met. In other cases, CDRH has permitted some PMAs to be submitted when a pre-specified number of patients had been followed in accordance with the investigational plan. Data on the remaining patients were submitted post-filing as a PMA amendment. This latter situation has normally been decided on a case-by-case basis. It should be noted that an unplanned early submission of data often creates evaluation difficulties. Therefore, FDA recommends that if a sponsor is considering submitting a PMA before the full cohort of patients has been followed according to the investigational plan, the firm should discuss its plan with the Agency.

#### **Hyperlink #5**

The role of postmarketing information should be considered in determining the appropriate type/amount of data that should be collected in the premarket setting to support PMA approval. These discussions should occur early in the device development process rather than when approval of the application is being decided. Discussions between FDA staff and industry may be informal and occur as a part of the pre-IDE process ([www.fda.gov/cdrh/ode/d99-1.html](http://www.fda.gov/cdrh/ode/d99-1.html)). Alternatively, they may be more formal and be a part of the early collaboration Agreement/Determination meeting process ([www.fda.gov/cdrh/ode/guidance/310.pdf](http://www.fda.gov/cdrh/ode/guidance/310.pdf)).

To illustrate how postmarketing information may be used to help decide what type of data are needed for PMA approval, consider the decision with regard to brachytherapy for the reduction



of in-stent restenosis. Recognizing that long-term information on the effect of radiation on the restenosis rate and the incidence of thrombosis was needed, a postmarket trial was agreed upon during the approval process. This least burdensome approach allowed patients to have access to this promising new technology but also permitted CDRH to gain long-term safety and effectiveness data. Similarly, CDRH approved a biliary lithotripter based on data demonstrating that the device could break up biliary stones. Postapproval data will be collected to demonstrate whether the device, in combination with drug therapy, results in improved clinical outcome.

#### **Hyperlink #6**

FDA has recognized over 600 voluntary consensus standards. (For a searchable database of standards, see [www.fda.gov/cdrh/stdsprog.html](http://www.fda.gov/cdrh/stdsprog.html)). Some of these standards relate to individual products while others address crosscutting issues such as electrical safety, sterilization, and biocompatibility. For example, CDRH has recognized 28 voluntary consensus standards that address numerous aspects of wheelchair performance. While most wheelchairs are Class II devices, many of these standards are applicable to the Class III stair climbing wheelchairs. Other device-specific standards include the ISO standards for heart valves and vascular grafts and the NCCLS standards that apply to most *in vitro* diagnostic devices. Cross-cutting standards, such as the IEC electrical safety and ISO sterilization standards, apply to numerous device types reviewed by the Center. Declarations of conformity to standards that identify test methods can reduce the detail needed in PMA submissions and eliminate FDA review of test procedures. Use of those standards that have performance criteria can further reduce data reporting requirements in the application and save review time.

#### **Hyperlink #7**

The purpose of a 510(k) submission is to determine whether the device is "substantially equivalent" to a predicate device. Section 513(i) of the act establishes the criteria for determining whether a device is "substantially equivalent." This section of the act states that FDA may issue an order of substantial equivalence only if it determines that the device has the same intended use as a predicate device and is as safe and effective as a legally marketed device.

Information unrelated to the substantial equivalence determination should not be requested or reviewed by FDA. As with PMAs, this would normally include information related to cost-effectiveness and consumer preference testing. In addition, information that is scientifically interesting but not necessary for purposes of determining substantial equivalence should not be part of a submission. As an example, consider a device-specific guidance document for diagnostic ultrasound. In accordance with the least burdensome approach, this guidance is in the process of being modified to remove the request for routine submission of Doppler sensitivity test results since this information is not needed to make an equivalency determination.

#### **Hyperlink #8**

The 510(k) process is not a mechanism for ensuring compliance with all FDA regulations that may apply to a particular device. Manufacturers of 510(k) devices are required to comply with a number of regulations, including the labeling requirements in 21 CFR 801 (and 809.10 for IVDs)

as well as the good manufacturing requirements in Section 820. To illustrate the appropriate scope of a 510(k) review, consider the following least burdensome approach to the review of labeling. In accordance with 21 CFR 807.87(e), a 510(k) submitter should provide “proposed labels, labeling, and advertisements sufficient to describe the device, its intended use, and the directions for its use.” While 21 CFR 801 contains specific requirements with which 510(k) holders must comply, ensuring compliance with this regulation should not be part of the SE determination. Instead, for purposes of the SE determination, FDA should ensure that the information required by section 807.87(c) (i.e., description of the device, its intended use, and the instructions for use) or labeling that is serving as a special control is provided in the submission.

Similarly, 21 CFR 809.10 governs the labeling for in vitro diagnostics (IVDs) and specifies very detailed information that is to be included in the labeling for all IVDs. It should be recognized, however, that 21 CFR 809.10 applies not only to IVDs undergoing review by FDA in 510(k) submissions, but also to the numerous Class I and II IVDs that are exempt from 510(k) requirements. A least burdensome approach to the 510(k) review of IVDs would rely on the industry’s legal obligation to meet the requirements of 21 CFR 809.10. FDA would focus its review of the labeling on the required elements identified in 21 CFR 807.87(e), as discussed above. This least burdensome approach to the review of labeling in IVD 510(k)s would not interfere with FDA’s ability to obtain whatever data or information are necessary to make the SE determination.

#### **Hyperlink #9**

Clinical data are not required for most 510(k)s. Consequently, the Agency should clearly document the issue that warrants a request for such data. In addition, FDA should work with industry to identify the type and extent of data that will be required for clearance. For example, clinical data may be needed to address how a new material will wear when exposed to physiological loading in humans. In this case, CDRH should explain why animal testing would not be sufficient and work with the company to identify the type and extent of the data that will be needed. This would include parameters such as the number of patients, endpoints, and length of follow-up.

When designing the clinical study, as discussed above for PMAs, FDA and industry should consider alternatives to RCTs. Below are examples of recent SE determinations that relied on alternative study designs:

To support the clearance of a Hepatitis A diagnostic test, CDRH requested that a prospective clinical study be conducted using patient serum and plasma samples with elevated levels of lipid, hemoglobin, and bilirubin. Industry proposed a least burdensome alternative approach. In their proposal, which was accepted by CDRH, interference testing would be conducted by adding known concentrations of lipid, hemoglobin, and bilirubin to banked serum and plasma samples (i.e., spiked samples) and comparing these results to the testing conducted on unspiked samples.

To support the clearance of an electrosurgical device for a specific medical indication, CDRH requested a side-by-side comparison of the performance of the investigational device versus a predicate device on extirpated human tissue. Industry proposed that an animal model, which is the established standard for such performance testing for this type of device, be used rather than human tissue. CDRH agreed to accept data from the valid animal model.

#### **Hyperlink #10**

To illustrate the effective use of FDA recognized standards in the review process, consider CDRH's guidance document entitled, "*Latex Condoms for Men: Information for 510(k) Premarket Notifications: Use of Consensus Standards for Abbreviated Submissions*" ([www.fda.gov/cdrh/ode/92\\_b.html](http://www.fda.gov/cdrh/ode/92_b.html)). The Center's approach to demonstrating substantial equivalence for latex condoms relies heavily on conformance to several recognized voluntary standards. Rather than submitting performance data for review in the 510(k), the approach recommended in this guidance document is to do the testing required by the recognized standards and to submit Declarations of Conformity to the standards. This approach not only supports the use of standards as intended by FDAMA, but also takes advantage of the Abbreviated 510(k) option created under "The New 510(k) Paradigm."<sup>12</sup>

As a second example of how CDRH has incorporated the use of standards in the 510(k) process, consider how the Center has relied on the requirements of the Radiation Control for Health and Safety Act (RCHSA). 21 CFR 1050 establishes federal performance standards under RCHSA for non-ionizing radiation diagnostic devices. In the past, data demonstrating conformance with these standards have routinely been submitted in traditional 510(k)s. Recently, the reviewing division provided guidance that encourages industry to submit a certification that the appropriate testing has been completed in accordance with the FDA recognized standards rather than submitting the supporting data in a 510(k).

#### **Hyperlink #11**

Under the guidance document entitled, "Deciding When to Submit a 510(k) for a Change to an Existing Device,"<sup>13</sup> 510(k) holders have latitude in making modifications to their legally marketed devices without the need for submitting new premarket notifications under certain conditions. The guidance contains flowcharts that 510(k) holders may use to assess whether a labeling, technology/performance specification, or materials change requires the submission of a new 510(k). If the manufacturer determines, based on a comparison of the modified device to an earlier version of its device that the Agency cleared (or to its legally marketed preamendments device), that a new 510(k) is not needed, the manufacturer may modify the device and maintain records of the decision-making process.

<sup>12</sup>This guidance can be found at: [www.fda.gov/cdrh/ode/parad510.html](http://www.fda.gov/cdrh/ode/parad510.html)

<sup>13</sup>This guidance can be found at: [www.fda.gov/cdrh/ode/510kmod.html](http://www.fda.gov/cdrh/ode/510kmod.html)

This process creates some difficulties for FDA when assessing a 510(k) for a device that has been modified during the product life cycle but is now being modified in a way that requires 510(k) clearance. A least burdensome approach to this situation would involve focusing on the information that relates exclusively to the modification that triggered the need for a new 510(k). However, because device performance may depend on many aspects of overall device design, not just the change that is the subject of the new 510(k), there will be instances where testing of the overall device design is necessary to support a finding of substantial equivalence. In these instances, the reviewer should focus on the testing that is necessary to ensure that the overall device is as safe and effective as a legally marketed predicate. That is, industry could present data to compare the modified device that triggered the need for a new 510(k) submission with an earlier version of the device that represents a series of changes that by themselves did not require 510(k) clearance, or the submitter could claim equivalence to a competitor's legally marketed device. In either case, the least burdensome approach would be one in which FDA focuses on the overall performance of the device in making the substantial equivalence determination rather than on the intermediate changes that did not require 510(k) submission.

#### **Hyperlink #12**

Manufacturing and quality control information should not be part of a 510(k) submission unless the information relates to the equivalency determination. The 510(k) process focuses primarily on the end product of the manufacturing process rather than the manufacturing process itself. The Quality Systems (QS) regulation requires device manufacturers to perform design verification and validation testing, as appropriate, on new devices as well as on modifications to existing devices. FDA should ask, however, only for test results that are necessary to make an equivalency determination. For example, in Special 510(k)s, manufacturers submit certain design control information to establish substantial equivalence. Routine submission and review of design verification and validation data generated in accordance with the QS regulation, however, would delay review of 510(k)s without contributing to the SE determination.

To further illustrate this point, consider CDRH's updated policy regarding sterilization. Under this guidance, submitters of 510(k)s for devices that will be labeled sterile should provide the sterilization method, the sterility assurance level (SAL), a description of the packaging used to maintain sterility of the device, and a description of the method that will be used to validate the sterilization cycle, but not the validation data itself ([www.fda.gov/cdrh/ode/guidance/361.html](http://www.fda.gov/cdrh/ode/guidance/361.html)). In the past, the sterilization policy distinguished between "traditional" and "non-traditional" methods of sterilization. That is, submitters of 510(k)s for devices for which a non-traditional method of sterilization was being used should have included process verification and validation data demonstrating that the final device met its release specifications. In the updated guidance, a least burdensome approach to sterility in 510(k) submissions is employed which relies on a manufacturer's legal obligation to comply with the Quality Systems requirements, including the assurance of the sterility of finished devices. This policy applies to 510(k)s for all devices labeled as sterile, regardless of the method of sterilization that a manufacturer chooses to employ. Sterility of the finished device is addressed through the regulatory requirement that a manufacturer conduct proper process verification and validation studies. These studies ensure the adequacy of the manufacturing process, including the sterilization process, to produce a device which meets the specifications described in the manufacturer's 510(k). The data resulting

from these studies, however, would not be submitted in the 510(k), but rather would be maintained by the manufacturer. To help maintain consistency in the Agency's review of non-traditional methods of sterilization, all 510(k)s for devices for which a non-traditional sterilization method is used will be referred to a central contact within the Office of Device Evaluation during the review process. This contact will work with the Office of Compliance to determine whether an inspection of the sterilization facility should be a priority. For certain non-traditional sterilization methods, (e.g., those involving a unique or novel sterilant that the agency has not previously seen in a 510(k)), the agency would consider if additional information or a preclearance inspection is warranted. It should be noted, however, that a manufacturer's use of a non-traditional sterilization method should not ordinarily affect or delay a substantial equivalence determination.

### **Hyperlink #13**

FDAMA and CDRH's reengineering efforts provided the Agency and the industry with a variety of tools that can be used to lessen the regulatory burden. Consider new section 513(f)(2) of the act entitled, "Evaluation of Automatic Class III Designation," commonly referred to as the *de novo* process ([www.fda.gov/cdrh/modact/classiii.html](http://www.fda.gov/cdrh/modact/classiii.html)), and what it can afford when combined with the opportunities created through 510(k) reengineering efforts, such as "The New 510(k) Paradigm."<sup>14</sup> The *de novo* process has been successfully used many times. In each case, FDA determined that either general controls alone, or general controls combined with special controls, could ensure the safety and effectiveness of the new device, thus avoiding the more burdensome PMA process. The *de novo* process, when combined with the opportunity for 510(k) exemption and the flexibility created by "The New 510(k) Paradigm," creates an effective mechanism for matching the necessary regulatory controls to the risks of the device.

As an example, consider the new generation of surgical instruments that represent computer-assisted versions of traditional devices. Surgical instruments are for the most part Class I 510(k) exempt devices. Significant changes in technology could easily place these devices in Class III subject to PMA. Where there is a clear understanding of the risks that are inherent with these new surgical technologies and special controls can be developed to address them, FDAMA's *de novo* process would allow CDRH to place these types of devices in Class II subject to general and special controls. This classification, when combined with the use of voluntary consensus standards and conformance with design controls under the QS regulation, could permit new and modified devices to get to market in a least burdensome manner.

As a specific example of how "The New 510(k) Paradigm" can be used to reduce regulatory burden, consider a design change to a class II electrophysiology (EP) catheter. A 510(k) holder of a legally marketed EP catheter wanted to alter the shape of the curve of the device. After conducting a risk analysis of the change and completing certain design verification/validation activities required under the QS regulation, the company concluded that the redesigned device was as safe and effective as its marketed device. After considering the alternative approaches presented in The New 510(k) Paradigm, the company determined that a Special 510(k) represented the least burdensome approach to getting clearance for the EP catheter and,

<sup>14</sup> This guidance can be found at [www.fda.gov/cdrh/ode/parad510.html](http://www.fda.gov/cdrh/ode/parad510.html)

therefore, submitted this type of 510(k) for the change.

#### **Hyperlink #14**

The reclassification and exemption processes should be used to ensure that the proper level of regulatory control is applied to a device type. The Safe Medical Devices Act of 1990 (SMDA) and FDAMA, by facilitating the reclassification and exemption processes, reinforced the Medical Device Amendments of 1976 directive to continue to consider the lowest appropriate level of regulatory control sufficient to provide reasonable assurance of the safety and effectiveness of the device. As a result, FDA has reclassified numerous devices, including many preamendments Class III devices, into Class II. In other cases, special controls have been used to streamline the 510(k) Program by allowing Class II devices to be exempt from the premarket notification requirements.

The Agency should continue to look for reclassification opportunities and should show the same level of commitment to addressing reclassification petitions as it does marketing applications. Industry also should take advantage of these tools and submit reclassification petitions and/or exemption requests when appropriate. To help expedite the reclassification process, industry should include draft special control guidance documents in reclassification petitions, when appropriate. Guidance<sup>15</sup> is also available to help industry develop requests for 510(k) exemptions. Thus, use of general and/or special controls could allow certain devices to be downclassified and perhaps even made 510(k) exempt, while still providing reasonable assurance of the safety and effectiveness of the device.

#### **Hyperlink #15**

Since SMDA, FDA has been challenged to rely on postmarket controls to reduce the premarket burden for all classes of devices. In FDAMA, however, Congress made its intention explicit by adding two new sections to the statute. Specifically, new section 513(a)(3)(C) states, "...the Secretary shall consider whether the extent of data that otherwise would be required for approval of the application with respect to effectiveness can be reduced through reliance on postmarket controls." Similarly, new section 513(i)(1)(C) states, "To facilitate reviews of reports submitted to the Secretary under section 510(k), the Secretary shall consider the extent to which reliance on postmarket controls may expedite the classification of devices ...."

The postmarket controls to which the statute is referring include controls such as the QS regulation, postmarket surveillance, and the Medical Device Reporting (MDR) requirements. For 510(k)s, "The New 510(k) Paradigm"<sup>16</sup> advocates relying on design controls, a critical part of the QS regulation, to address certain design modifications. Under The Paradigm, changes that do not affect the fundamental scientific technology or intended use of the device may be submitted as Special 510(k)s. For these well-defined modifications, "the Agency believes that the rigorous design control procedure requirements produce highly reliable results that can form,

<sup>15</sup> "Procedures for Class II Device Exemptions from Premarket Notification" can be found at: [www.fda.gov/cdrh/modact/exemii.html](http://www.fda.gov/cdrh/modact/exemii.html)

<sup>16</sup> This guidance can be found at [www.fda.gov/cdrh/ode/parad510.html](http://www.fda.gov/cdrh/ode/parad510.html)

in addition to the other 510(k) content requirements ..., a basis for the substantial equivalence determination.” Thus, for Special 510(k)s, industry submits a summary of its design control activities and a declaration of conformity to design controls, but the data generated as a result of the design control procedures are maintained by the manufacturer and not submitted to the Agency.

Examples of changes permitted through the Special 510(k) option include replacing a polyurethane coating with a silicone coating on an electrode, adding a scanner to a Er:YAG laser, and adding a new algorithm to an EEG to assist in test data interpretation. In each of these instances, manufacturers conducted verification and validation testing, as appropriate, to support the device modification. Results of the testing are maintained by the manufacturer but are available for FDA inspection. Thus, use of this postmarket control can significantly reduce the premarket burden and, as indicated in the statute, “expedite the classification of devices.”

There is also a broader and more fundamental aspect of design control requirements. As indicated in the human factors guidance document,<sup>17</sup> human factors are an important consideration in a device manufacturer’s quality assurance program, particularly the design control section of the QS regulations. The implementation of good human factors practices, through the design control requirements, can help to ensure that medical devices are as safe and effective as reasonably possible. Identifying and addressing issues associated with safe device use can be accomplished through discussions between the industry and the Human Factors Engineering Group during the device design and development phases. This approach would facilitate the review of PMAs and 510(k)s by permitting FDA’s review scientists to focus their efforts on those aspects of the final device design that relate to safety and effectiveness or substantial equivalence, but would still ensure that human factors issues are addressed.

There are other postmarket controls the Agency may rely on to reduce premarket burden, such as postmarket surveillance. With industry commitment, this control can be effectively used to address long-term safety and effectiveness issues. For example, when manufacturers wished to add a new type of porous coating to their hip implants, long-term safety and effectiveness could not be determined based on the available premarket data. Using a least burdensome approach, CDRH cleared the devices with short-term data but required that postmarket surveillance be conducted on the implanted patients to address the long-term safety issues.

The MDR regulation is a control that allows FDA to monitor postapproval use of all medical devices, both 510(k) and PMA. This postmarketing control is used to alert the Agency to unanticipated events that may occur as a result of actual use situations, including, e.g., interference with other products or user error.

#### **Hyperlink #16**

FDA and industry should make effective use of well-designed bench and/or animal testing. The testing should be designed to address a specific question, use standards or standardized test methods, employ scientifically relevant end-points, and use the most appropriate bench and/or

---

<sup>17</sup> “An Introduction to Human Factors” can be found at: [www.fda.gov/cdrh/humfac/doitpdf.pdf](http://www.fda.gov/cdrh/humfac/doitpdf.pdf)

animal model. For example, consider changes to the shape of the optic for an intraocular lens (IOL). For this type of device modification, there is well-established optical bench testing that serves as an accurate predictor of effectiveness for the particular optic design. As a second example, consider strength and fatigue testing that is used to assess certain aspects of the long-term performance of many orthopedic implants. This testing has been carefully designed to predict whether a particular implant design is able to withstand the stresses that the device will be subjected to over its useful life. Furthermore, this type of testing is well accepted by orthopedic device manufacturers and CDRH as a predictor of proper device design. Thus, the use of well-designed testing, such as that discussed in the above examples, helps to ensure that the relevant questions are satisfactorily addressed in the least burdensome manner.

#### **Hyperlink #17**

An effective use of incorporating by reference other premarket submissions, rather than re-submitting duplicative information, can be found in the IDE/PMA process. Biocompatibility and/or bench testing is needed to support approval of almost all IDEs. If this testing remains valid at the time the PMA is being prepared, that is, the investigational device was not modified during the course of the trial such that the testing would need to be repeated, the manufacturer could reference this testing in the PMA submission. This approach would also save review resources, since this information would not need to be re-reviewed, unless a new issue had been identified. For PMA supplements, industry should incorporate relevant data and information that have been previously submitted in the original PMA whenever possible, as discussed in the guidance document entitled, "Guidance for Industry -- Supplements to Approved Applications for Class III Medical Devices: Use of Published Literature, Use of Previously Submitted Materials, and Priority Review" ([www.fda.gov/cdrh/modact/evidence.html](http://www.fda.gov/cdrh/modact/evidence.html)). Similarly, if certain sections of an IDE (clinical protocol, case report forms, etc.) are relevant for a second IDE, the sponsor may wish to reference those sections rather than resubmit the information to the Agency. Incorporating information should conserve FDA review resources as well as preparation time on the part of the industry.

It should be noted, however, that there are certain cases in which resubmission of information may be more efficient than referencing a previously submitted file. For example, if an IDE has been closed, it would most likely be in the manufacturer's best interest to resubmit the relevant sections of the closed IDE rather than have the reviewer try to access the file.

#### **Hyperlink #18**

FDA reviewers should avoid focusing their efforts on ensuring compliance with FDA statutes or regulations unrelated to premarket decisions. For example, consider the Quality Systems regulation. GMP issues should not affect substantial equivalence determinations in accordance with the new provisions of FDAMA. Under section 513(f)(5) of the act, FDA may not withhold a 510(k) determination because of a failure to comply with any provision of the act unrelated to a SE decision, including a finding that the facility in which the device is manufactured is not in compliance with GMPs (other than a finding that there is substantial likelihood that the failure to comply will potentially present a serious risk to human health).



Similarly, FDA reviewers should not attempt to verify compliance with laws and regulations administered by other federal agencies as a part of the clearance or approval decision. For example, manufacturers of medical devices must adhere to the regulations of the Occupational Safety and Health Administration (OSHA) when manufacturing their devices. While it is important for the safety of the worker that OSHA's regulations are followed, verifying conformance with them is not relevant to the SE or approval decisions. Consider, for example, that OSHA has its own guidelines to help protect operators of lasers and electrosurgical devices from "plume" in the healthcare setting independent of that which CDRH requires for approval of these devices.

Having stated the above, it is important to note that while information about a device that does not relate to a premarket decision should not delay the Agency's clearance or approval decision, it may be appropriate for FDA to follow up on such information through other avenues. Therefore, if the Agency becomes aware of information that may represent non-compliance with its own or another agency's laws or regulations unrelated to the premarket decision, staff should follow up through appropriate channels. In the case of a potential problem with GMPs, for example, FDA reviewers should notify the appropriate center's Office of Compliance about the potential problem but should not hold up the substantial equivalence decision unless there is a substantial likelihood that the problem may present a risk to health. No reviewer should hold up a SE determination on this basis without supervisory review and concurrence.

#### **Hyperlink #19**

Often times during the course of the review of a document, FDA needs to obtain additional information from the submitter. Similarly, industry often needs to respond to these Agency requests. In these situations, FDA staff and industry should follow the format outlined in the document entitled, "Suggested Format for Developing and Responding to Deficiencies in Accordance with the Least Burdensome Provisions of FDAMA"<sup>18</sup> to help ensure that the requests and the responses to them are direct, concise, and complete.

#### **Hyperlink #20a**

A draft guidance document for modifications to intraocular lenses (IOLs), a well-understood implantable device, illustrates the sound application of the least burdensome principles. (See [www.fda.gov/cdrh/ode/iol-guidance.pdf](http://www.fda.gov/cdrh/ode/iol-guidance.pdf)) This document identifies the requirements for establishing safety and effectiveness for a wide variety of potential device modifications. Based on the potential impact of a given modification, the modified IOL may be marketed based on:

- No prior approval required (the validating information is summarized in the PMA annual report);
- Non-clinical data;
- Limited, confirmatory clinical data; or
- Full clinical study (equivalent to that for new device).

#### **Hyperlink #20b**

---

<sup>18</sup> This guidance is available at: [www.fda.gov/cdrh/modact/guidance/1195.html](http://www.fda.gov/cdrh/modact/guidance/1195.html)

Under a new amendment to the IDE regulation (21 CFR 812.35(a)(3)), sponsors may make certain modifications to their device design/manufacturing process and/or their clinical protocol without prior FDA approval of a supplement if the changes are reported to the Agency within 5 days of implementation. (Section 520(g)(6) of the act) For developmental changes in the device (including manufacturing modifications), the change must not constitute a significant change in design or in basic principles of operation of the device. To help sponsors decide if a proposed change meets these statutory criteria, the regulation recommends that sponsors use design controls, preclinical/animal testing, peer reviewed published literature, or other information, such as preliminary results of their clinical trial or marketing experience gained outside the U.S. Protocol changes that do not affect the rights, safety or welfare of the subjects, scientific soundness of the investigational plan, validity of the data, or the risk to benefit relationship may also be made without prior FDA approval. As with device modifications, the sponsors should use peer reviewed published literature, preliminary results of their clinical trial or marketing experience gained outside the U.S., or the recommendations of their clinical investigators to support the protocol changes. If there is any question whether a proposed device/manufacturing or protocol change would meet the statutory criteria for implementation without prior FDA approval, sponsors are encouraged to consult the guidance document entitled, "Changes or Modifications During the Conduct of a Clinical Investigation" ([www.fda.gov/cdrh/ode/guidance/1337.pdf](http://www.fda.gov/cdrh/ode/guidance/1337.pdf)) or to discuss the change with the IDE Staff or the appropriate review division.

By allowing IDE sponsors to proceed with certain types of device design/manufacturing and protocol changes without prior FDA approval of an IDE supplement, the regulatory burden on IDE sponsors should be reduced. Furthermore, the alternative approaches provided to IDE sponsors in the regulation exemplify the sound application of the least burdensome principles.

---

---

APPENDIX J—TECHNOLOGY EVALUATION CENTER, BLUE CROSS AND  
BLUE SHIELD ASSOCIATION

---

---

# Vagus Nerve Stimulation for Treatment-Resistant Depression



Assessment  
Program  
Volume 20, No. 8  
August 2005

## Executive Summary

Depression is a serious psychiatric condition that sometimes does not respond to standard treatments such as medication and/or psychotherapy. Vagus nerve stimulation (VNS) therapy is a type of treatment administered through an implanted pulse generator and bipolar lead that has been studied in patients with treatment-resistant depression. This Assessment will review the available evidence to determine if VNS therapy is effective for treatment-resistant depression.

Based on the available evidence, the Blue Cross and Blue Shield Association Medical Advisory Panel made the following judgments about whether vagal nerve stimulation for the indication of treatment-resistant depression meets the Blue Cross and Blue Shield Association Technology Evaluation Center (TEC) criteria.

### 1. The technology must have final approval from the appropriate governmental regulatory bodies.

The NeuroCybernetic Prosthesis System (NCP®, Cyberonics, Inc.) received approval of its Premarket Application (PMA) to market from the U.S. Food and Drug Administration (FDA) on July 16, 1997, for treatment-refractory seizures. The device was approved for use in conjunction with drugs or surgery “as an adjunctive treatment of adults and adolescents over 12 years of age with medically refractory partial onset seizures.”

On July 15, 2005, the VNS Therapy System received final PMA approval by the FDA for “adjunctive long-term treatment of chronic or recurrent depression for patients 18 years of age or older who are experiencing a major depressive episode and have not had an adequate response to 4 or more adequate antidepressant treatments.”

### 2. The scientific evidence must permit conclusions concerning the effect of the technology on health outcomes.

The available evidence is not sufficient to permit conclusions of the effect of VNS therapy on health outcomes. The available evidence consists of a case series of 60 patients receiving VNS, a short-term (i.e., 3-month) randomized, sham-controlled clinical trial of 221 patients, and an observational study comparing 205 patients on VNS therapy compared to 124 patients receiving ongoing treatment for depression. Patients who responded to sham treatment in the short-term randomized, controlled trial (approximately 10%) were excluded from the long-term observational study.

Patient selection was a concern for all studies. VNS is intended for treatment-refractory depression, but the entry criteria of failure of 2 drugs and a 6-week trial of therapy may not be a strict enough definition of treatment resistance. Treatment-refractory depression should be defined by thorough state-of-the-art psychiatric evaluation and management.

NOTICE OF PURPOSE: TEC Assessments are scientific opinions, provided solely for informational purposes. TEC Assessments should not be construed to suggest that the Blue Cross Blue Shield Association, Kaiser Permanente Medical Care Program or the TEC Program recommends, advocates, requires, encourages, or discourages any particular treatment, procedure, or service; any particular course of treatment, procedure, or service; or the payment or non-payment of the technology or technologies evaluated.



BlueCross  
BlueShield  
Association

An Association  
of Independent  
Blue Cross and  
Blue Shield Plans



KAISER  
PERMANENTE

©2005 Blue Cross and Blue Shield Association. Reproduction without prior authorization is prohibited.

1

The case series data show rates of improvement, as measured by a 50% improvement in depression score of 31% at 10 weeks to greater than 40% at 1 to 2 years, but there are some losses to follow-up. Natural history, placebo effects, and patient and provider expectations make it difficult to infer efficacy from case series data.

The randomized study that compared VNS therapy to a sham control (implanted but inactivated VNS) showed a nonstatistically significant result for the principal outcome. Fifteen percent of VNS subjects responded, versus 10% of control subjects ( $p=0.31$ ). There was a statistically significant result for a secondary outcome.

An observational study comparing patients participating in the randomized clinical trial and a separately recruited control group evaluated VNS therapy out to 1 year. This observational study showed a statistically significant difference in the rate of change of depression score. However, issues such as unmeasured differences between patients and nonconcurrent controls, differences in sites of care between VNS therapy patients and controls, and differences on concomitant therapy changes raise concern about this observational study. Analyses performed on subsets of patients cared for in the same sites, and censoring observations after treatment changes, generally showed diminished differences in apparent treatment effectiveness of VNS and almost no statistically significant differences. Given these concerns about the quality of the observational data, these results do not provide strong evidence for the effectiveness of VNS therapy.

Adverse effects of VNS therapy include voice alteration, headache, neck pain, and cough, which are known from prior experience with VNS therapy for seizures. Regarding specific concerns for depressed patients such as mania, hypomania, suicide, and worsening depression, there does not appear to be a greater risk of these events during VNS therapy.

3. **The technology must improve the net health outcome; and**
4. **The technology must be as beneficial as any established alternatives.**

The available evidence does not permit conclusions regarding the effect of VNS therapy on health outcomes or compared with alternatives.

5. **The improvement must be attainable outside the investigational settings.**

It has not yet been demonstrated whether VNS therapy improves health outcomes in the investigational setting. Therefore, it cannot be demonstrated whether improvement is attainable outside the investigational settings.

For the above reasons, VNS therapy for the indication of treatment-resistant depression does not meet the TEC criteria.

<b>Contents</b>			
<b>Assessment Objective</b>	<b>4</b>	<b>Review of Evidence</b>	<b>9</b>
<b>Background</b>	<b>4</b>	<b>Summary of Application of the Technology Evaluation Criteria</b>	<b>17</b>
<b>Methods</b>	<b>6</b>	<b>References</b>	<b>19</b>
<b>Formulation of the Assessment</b>	<b>7</b>		

**Published in cooperation with Kaiser Foundation Health Plan and Southern California Permanente Medical Group.**

**TEC Staff Contributors**

Author—David Mark, M.D., M.P.H.; TEC Executive Director—Naomi Aronson, Ph.D.; Managing Scientific Editor—Kathleen M. Ziegler, Pharm.D.; Research/Editorial Staff—Claudia J. Bonnell, B.S.N., M.I.S.; Maxine A. Gere, M.S.

**Blue Cross and Blue Shield Association Medical Advisory Panel**

Allan M. Korn, M.D., F.A.C.P.—Chairman, *Senior Vice President, Clinical Affairs/Medical Director, Blue Cross and Blue Shield Association*; Alan M. Garber, M.D., Ph.D.—Scientific Advisor, *Staff Physician, U.S. Department of Veterans Affairs*; Henry J. Kaiser, Jr., Professor, and Professor of Medicine, Economics, and Health Research and Policy, *Stanford University*; Steven N. Goodman, M.D., M.H.S., Ph.D.—Scientific Advisor, *Associate Professor, Johns Hopkins School of Medicine, Department of Oncology, Division of Biostatistics (joint appointments in Epidemiology, Biostatistics, and Pediatrics)*—American Academy of Pediatrics Appointee.

■ **Panel Members** Peter C. Albertsen, M.D., Professor, *Chief of Urology, and Residency Program Director, University of Connecticut Health Center*; Edgar Black, M.D., *Vice President, Chief Medical Officer, BlueCross BlueShield of the Rochester Area*; Helen Darling, M.A., *President, National Business Group on Health*; Josef E. Fischer, M.D., F.A.C.S., *Mallinckrodt Professor of Surgery, Harvard Medical School and Chair, Department of Surgery, Beth Israel Deaconess Medical Center*—American College of Surgeons Appointee; Willard K. Harms, M.D., M.M., *Medical Director, Medical Policy and Adjudication, Blue Cross Blue Shield of Illinois*; Michael A.W. Hattwick, M.D., *Woodburn Internal Medicine Associates, Ltd.* American College of Physicians Appointee; I. Craig Henderson, M.D., *Adjunct Professor of Medicine, University of California, San Francisco*; Mark A. Hlatky, M.D., *Professor of Health Research and Policy and of Medicine (Cardiovascular Medicine), Stanford University School of Medicine*; Bernard Lo, M.D., *Professor of Medicine and Director, Program in Medical Ethics, University of California, San Francisco*; Barbara J. McNeil, M.D., Ph.D., *Ridley Watts Professor and Head of Health Care Policy, Harvard Medical School, Professor of Radiology, Brigham and Women's Hospital*; Brent O'Connell, M.D., M.H.S.A., *Vice President and Medical Director, Pennsylvania Blue Shield/Highmark, Inc.*; William R. Phillips, M.D., M.P.H., *Clinical Professor of Family Medicine, University of Washington*—American Academy of Family Physicians' Appointee; Maren T. Scheuner, M.D., M.P.H., *Visiting Associate Professor, Department of Health Services, UCLA School of Public Health*—American College of Medical Genetics Appointee; J. Sanford Schwartz, M.D., *Professor of Medicine, Department of Medicine, University of Pennsylvania School of Medicine and Professor, Health Care Systems, Health Management & Economics, The Wharton School*; Earl P. Steinberg, M.D., M.P.P., *President, Resolution Health, Inc.*; A. Eugene Washington, M.D., M.Sc., *Executive Vice Chancellor, University of California, San Francisco*; Jed Weissberg, M.D., *Associate Executive Director for Quality and Performance Improvement, The Permanente Federation.*

CONFIDENTIAL: This document contains proprietary information that is intended solely for Blue Cross and Blue Shield Plans and other subscribers to the TEC Program. The contents of this document are not to be provided in any manner to any other parties without the express written consent of the Blue Cross and Blue Shield Association.

### Assessment Objective

Depression is a serious psychiatric condition that sometimes does not respond to standard treatments such as medication and/or psychotherapy. Vagus nerve stimulation (VNS) therapy is a type of treatment administered through an implanted pulse generator and bipolar lead that has been studied in patients with treatment-resistant depression. This Assessment will review the available evidence to determine if VNS therapy is effective for treatment-resistant depression.

### Background

#### Depression

Depression is a very common disorder that is most often chronic or recurrent in nature. In the U.S., the lifetime prevalence of major depressive disorder (MDD) is approximately 16%, and the 12-month period prevalence of MDD is approximately 7% (Kessler et al. 2005). Depression is associated with significant morbidity for the patient, patient's family, and society. Among the consequences of depression are functional impairment, impaired family and social relationships, and increased mortality from suicide and comorbid medical disorders.

Although there are many effective treatments for depression, it has been estimated that 10% to 20% of patients do not respond to treatment (Thase and Rush 1995). Furthermore, many responders do not respond completely. Such partial responders remain at substantial risk for recurrences of depression. There is little published evidence for any treatment strategy producing effective long-term control of depression in patients who fail to respond to initial antidepressant treatment.

There is no exact definition of treatment-resistant depression, but, in general, the term refers to patients who have not responded to adequate trials of several treatment strategies. Cadieux (1998) outlined 5 strategies for treating partial response or nonresponse to antidepressant therapy: 1) optimizing current therapy by dosage and duration; 2) substitution with different classes of pharmaceutical agents; 3) combining drugs; 4) electroconvulsive therapy; and 5) augmentation with drugs not routinely regarded as antidepressants such as lithium, thyroid hormone, or pindolol.

#### Vagus Nerve Stimulation

Traditionally the vagus nerve has been considered a parasympathetic efferent nerve controlling functions such as heart rate and gastric tone. However, it is actually a mixed nerve composed of about 80% afferent fibers carrying information to the brain from the head, neck, thorax, and abdomen. These fibers connect to many brain regions implicated in neuropsychiatric disorders (George et al. 2000).

For treatment of various illnesses, vagus nerve stimulation refers to stimulation of the left cervical vagus nerve using a commercial device, the NeuroCybernetic Prosthesis® (NCP®) System, manufactured by Cyberonics. This device has been used for the treatment of resistant seizure disorders in Europe since 1994 and in the U.S. since 1997. According to company documents, VNS devices have been implanted in more than 22,000 patients.

In addition to anatomic considerations that suggest that VNS therapy might have antidepressant effects, other types of evidence led to experimentation of this treatment for depression (George et al. 2000). Several studies have noted mood improvements in patients who had VNS devices implanted for seizure disorder. Elger et al. (2000) conducted a small study evaluating mood changes in patients receiving VNS for seizure disorder, showing improvements in mood score after VNS implantation. Imaging studies of patients who received VNS therapy showed changes in blood flow of several areas of the brain implicated in depression, and was consistent with VNS therapy having antidepressant activity. Also, anticonvulsant medications have antidepressant effects and electroconvulsive therapy (ECT), a potent treatment for depression, is known to have anticonvulsant effects.

#### VNS Implantation Procedure and Treatment.

Surgery for implantation of the device is done with the patient under either general anesthesia or regional cervical block. Since right vagus nerve stimulation produces bradycardia, implantation is limited to left-sided unilateral implantations. The carotid sheath is opened and 2 spiral electrodes are wrapped around the vagus and connected to an infraclavicular generator pack. In experienced hands, the entire procedure requires less than 2 hours. The programmable stimulator may be programmed in advance to stimulate at regular times or

upon demand by patients or family by placing a magnet against the subclavicular implant site. Stimulator settings are programmed to deliver intermittent stimulation with current of 0.25–3.0 mA, frequency of 20–50 Hz, and pulse width of 500 nanoseconds for 30–90 seconds every 5–10 minutes.

Adverse effects, such as injuries to the vagus nerve, are rare. Hoarseness, throat pain, and cough are common during stimulation, but are not life-threatening (Fisher et al. 1997). Infection necessitating removal of the device was reported in 1% of investigational device exemption (IDE) clinical trials for epilepsy indication and has been reported in 1% of commercial implants (U.S. Food and Drug Administration Center for Devices and Radiological Health 2004a). The most common nerve injuries are left vocal cord paralysis or left facial paralysis. The rate of nerve injuries reported in IDE clinical trials was 1% and 0.5% in commercial use.

The physician's manual for the device cites the following potential risks:

- the potential for human tissue damage if diathermy or full body magnetic resonance imaging is performed in a patient implanted with the VNS Therapy System
- the potential for degenerative nerve damage to the vagus nerve if it is stimulated excessively (i.e., if stimulation on time exceeds off time)
- aspiration related to stimulation-induced impairment of swallowing, especially in the presence of predisposing factors
- painful stimulation if the device malfunctions
- increased apneic events in patients with obstructive sleep apnea
- dyspnea, especially in the presence of obstructive airway disease
- transient bradycardia or asystole, especially during initial intraoperative lead testing
- surgical risks associated with the implant procedure, principally infection, vocal cord dysfunction due to manipulation of the vagus nerve, and other nerve damage
- a variety of nonserious side effects associated with stimulation, most commonly neck pain, dyspepsia, dysphagia, vomiting, paresthesia, increased cough, dyspnea, laryngismus, and voice alteration.

**FDA Status.** The NeuroCybernetic Prosthesis System (NCP®, Cyberonics, Inc.), a vagus nerve stimulation device, received approval of its Premarket Application (PMA) to market from the U.S. Food and Drug Administration (FDA) on July 16, 1997 for treatment-refractory seizures. The device was approved for use in conjunction with drugs or surgery “as an adjunctive treatment of adults and adolescents over 12 years of age with medically refractory partial onset seizures.” At that time, the FDA asked the company to provide detailed information about any deaths, especially unexpected, sudden deaths, in patients with the device; FDA also requested that the company further evaluate its study data to find out whether any factors predict which patients are most likely and/or least likely to benefit from use of the device (U.S. Food and Drug Administration 1997).

On July 15, 2005, the VNS Therapy System received final PMA approval by the FDA for “adjunctive long-term treatment of chronic or recurrent depression for patients 18 years of age or older who are experiencing a major depressive episode and have not had an adequate response to 4 or more adequate antidepressant treatments” (U.S. Food and Drug Administration Center for Devices and Radiological Health 2005).

In addition to other postapproval requirements, the FDA is requiring 2 specific postapproval studies “to further characterize the optimal stimulation dosing and patient selection criteria” (U.S. Food and Drug Administration Center for Devices and Radiological Health 2005). The first study is a “prospective, multicenter, randomized, double-blind comparison of different output currents in 450 new subjects with [treatment-resistant depression].” Effectiveness responses to differing output currents will be assessed 16 weeks after a 4- to 6-week titration period, during which concomitant therapies will not be changed. Study participants will be followed for at least 1 year after implantation to “further characterize duration of response as well as safety parameters at ... higher doses.” The second study is a “prospective, observation registry study of 1000 implanted subjects with [treatment-resistant depression] with follow-up extending to 5 years after implantation.” Postapproval study results and progress reports will be filed every 6 months. The FDA Center for Devices and Radiological Health may



request panel review of the postapproval data and, as necessary, will incorporate the results into supplemental labeling (U.S. Food and Drug Administration Center for Devices and Radiological Health 2005).

#### Outcome Assessment in Depression

There are several reasons to measure depressive symptoms in clinical practice or research. Most important for the purposes of this Assessment is to assess treatment outcome. In the research evaluating VNS therapy, the 4 most common instruments used are shown in Table 1. Except for the Clinical Global Impression (CGI) scale, the other instruments all involve answering specific inquiries regarding patient symptoms such as mood, affect, energy, appetite, sleep, and suicidal or paranoid ideation. Scale scores have been calibrated with clinical evaluation to correlate to severity levels of depression and changes in scores consistent with good treatment response or remission of depression. A typical threshold for categorizing clinically significant improvement is a 50% reduction from baseline score for any of the scales. The other method for categorizing treatment response is for the final value of the test to be below a particular value, indicating very few depressive symptoms. Studies have shown reasonable concordance between the Inventory of Depressive Symptomatology (IDS) and the Hamilton Rating Scale for Depression (HRSD) in categorizing patients as treatment responders (Rush et al. 2003).

Except for the self-administered version of the Inventory of Depressive Symptomatology (IDS-SR), the depression rating scales discussed here are designed to be administered by a health care clinician. The CGI scale is the most

inherently subjective scale, as it is simply a categorical 7-point scale asking whether, in the judgment of the clinician, the patient is very much improved (CGI=1) to very much worse (CGI=7). The CGI also requires an in-depth knowledge of the patient over the course of the treatment period.

## Methods

### Search Methods

A search of the MEDLINE® database was completed for the period up through July 2005. The search strategy used the terms “depression” and “vagus [or “vagal”] nerve stimulator/stimulation” as textwords or subject terms. Articles were limited to those published in English language and enrolling human subjects. The MEDLINE® search was supplemented by an examination of article bibliographies and relevant review articles, which were searched for citations.

In addition, documents were sought from the FDA website using the terms “Cyberonics,” “vagus nerve” or “vagal nerve.” Extracts of documents were reviewed if they concerned VNS therapy for the indication of depression.

### Study Selection

All the published and unpublished data concerning clinical outcomes of VNS therapy for the indication of treatment-resistant depression come from company-sponsored clinical studies. This report attempts to summarize the major findings from all of these studies. Different pieces of analysis are reported in various publications. Using the study names that the company used in their documents for FDA

**Table 1.** Depression Rating Scales Used in Evaluating VNS

Scale	Brief Description	Common Thresholds or Cutoffs for Treatment Response
Hamilton Rating Scale for Depression (HRSD)	Observer rated scoring of 28, 24, 21, or 17 two- to four-point items	50% reduction from base final rating of <9
Clinical Global Impression (CGI)	Observer rated 7-point scale 1. Severity of Illness (CGI-S) 2. Global Improvement (CGI-I)	Global Improvement=1 or 2
Montgomery and Asberg Depression Rating Scale (MADRS)	Observer rated scoring of 10 six-point items	50% reduction from baseline
Inventory of Depressive Symptomatology (IDS)	Observer-rated (IDS-C) or self-rated (IDS-SR) 30 three-point items	50% reduction from baseline

review (U.S. Food and Drug Administration Center for Devices and Radiological Health 2004a), the study groups assembled for the clinical studies will first be described, followed by a description of the analyses revealed in each of the available publications (Table 2).

Study D-01 was an open-label study of VNS therapy in 60 subjects. Short-term results for the first 30 patients and the whole group were published in peer-reviewed journals, as well as 1 year outcomes in the first 30 patients. Long-term results of the whole group are published in the Cyberonics Executive Summary (U.S. Food and Drug Administration Center for Devices and Radiological Health 2004a).

Study D-02 was a randomized sham-controlled study of 233 subjects allocated to either active VNS therapy or sham (i.e., VNS implanted but not turned on). This study was planned to evaluate outcomes at 3 months, and results are available in the Cyberonics Executive Summary (U.S. Food and Drug Administration Center for Devices and Radiological Health 2004a).

Study D-04 is an observational study of subjects not receiving VNS. This study was created to form a comparison group to a long-term extension of Study D-02, in which study subjects in both active and sham groups were followed for 1 year. The subjects in the original sham group had their VNS device activated. The results of the D-02 long-term extension group versus the observational control D-04 study group comprise the most extensive analysis presented in the Cyberonics Executive Summary (U.S. Food and Drug Administration Center for Devices and Radiological Health 2004a).

Finally, a matched control group receiving ECT was recreated from a previously published observational study by Prudic et al. (2004). Six-month results from this subgroup were compared to the D-02 extension study.

#### **Medical Advisory Panel Review**

**Current Assessment.** This Assessment was reviewed by the Blue Cross and Blue Shield Association Medical Advisory Panel (MAP) on June 8, 2005. In order to maintain the timeliness of the scientific information in this Assessment, literature searches were performed subsequent to the Panel's review (see "Search Methods"). If the search updates

identified any additional studies that met the criteria for detailed review, the results of these studies were included in the tables and text where appropriate. There were no studies that would change the conclusions of this Assessment.

**Previous Assessment.** A previous Assessment of vagus nerve stimulation for treatment-refractory seizures was reviewed by the MAP in February 1998. The MAP determined that vagus nerve stimulation for patients 12 years of age and older with medically refractory partial-onset seizures, for which surgery is not recommended or for which surgery has failed, met the TEC criteria. Vagus nerve stimulation for patients with other types of seizure disorders, which are medically refractory and for which surgery is not recommended or for which surgery has failed, did not meet the TEC criteria.

## **Formulation of the Assessment**

### **Patient Indications**

VNS is indicated for patients with treatment resistant depression. According to the study protocols for the D-01 and D-02 studies, patients enrolling in these studies had these characteristics:

- current major depression
- chronicity as defined by  $\geq 2$  year duration for the current episode or  $\geq 4$  lifetime episodes
- prior failure to respond to at least 2 adequate antidepressant treatments from 2 different drug classes
- prior failure of at least 6 weeks of psychotherapy
- minimum level of depression of 20 or greater on the HRSD-24.

Sackeim et al. (2001) describes other exclusion criteria for the D-01 study, such as exclusion of patients with certain other co-existing mental disorders, patients with clinically significant, current suicidal intent, and patients with certain risks associated with surgical implantation or VNS stimulation. It is not clear whether these exclusions apply to the D-02 study.

### **Technologies to be Compared**

VNS treatment will be compared to continued medical management.

**Table 2. Study Groups and Source of Results of VNS Studies**

Study Group	Description	Outcomes Analyzed	Publication of Results
D-01	Open-label study of 60 subjects receiving VNS	10-week outcomes of first 30 patients 10-week outcomes of 60 patients 1-year outcomes of first 30 patients	Rush et al. 2000 Sackeim et al. 2001 Marangell et al. 2002
		1- and 2-year outcomes of available subset of 60 patients	U.S. Food and Drug Administration Center for Devices and Radiological Health 2004a
D-02	Randomized sham-controlled trial of 233 subjects, VNS vs. sham	3-month outcomes of randomized sham vs. VNS groups	U.S. Food and Drug Administration Center for Devices and Radiological Health 2004a
D-04	Observational group of 124 patients NOT receiving VNS	1-year outcomes of D-02 extension study versus D-04 control group	U.S. Food and Drug Administration Center for Devices and Radiological Health 2004a
ECT control group	Matched subset of 172 from previously published observational study of ECT	1-year outcomes of D-02 extension study versus 6-month outcomes of ECT control group	U.S. Food and Drug Administration Center for Devices and Radiological Health 2004a

### Health Outcomes

**Potential Benefits.** The primary outcome to be evaluated is relief of depression symptoms. This can usually be assessed by any one of many different depression symptom rating scales. A 50% reduction from baseline score is considered to be a reasonable measure of treatment response. An improvement in depression symptoms may allow reduction of pharmacologic therapy for depression, with a reduction in adverse effects related to that form of treatment.

**Potential Harms.** Harmful outcomes of VNS would include any morbidity associated with the implantation of the device or adverse effects of the VNS therapy itself. Concern has been raised whether antidepressant treatments may worsen depression or even lead to suicide attempts. This is a controversial issue, not proven or established for any antidepressant therapy. The Cyberonics Executive Summary (U.S. Food and Drug Administration Center for Devices and Radiological Health 2004a) discussed the evidence for worsening depression and suicide in patients treated with VNS.

### Specific Assessment Questions

1. What is the effect of VNS therapy on treatment-resistant depression?
2. What are the adverse effects of VNS therapy?

## Review of Evidence

### Overview

Evidence for the effectiveness of VNS therapy comes from the studies described in the "study selection" section described previously (Table 2). Entry criteria and selected baseline characteristics of the subjects are shown in Table 3. Baseline characteristics of subjects from the D-02 and D-04 studies were not comprehensively presented in the Cyberonics Executive Summary (U.S. Food and Drug Administration Center for Devices and Radiological Health 2004a), so that the data presented represents a few characteristics that could be extracted from various parts of the report.

### D-01 Case Series

Results from the D-01 case series as extracted from several sources at different time points are presented in Table 4. After 10 weeks of active VNS therapy, 30.5% of subjects had a 50% reduction in the principal outcome of the HRSD-28. Other measures of improvement

ranged from 15% to 37.3%. In reports reporting outcomes at later time points, outcomes appear to continue to improve out to 1 year, where 45% of patients now had a 50% improvement in HRSD-28. This appears to stabilize out to 2 years, but there are substantial losses to follow-up at this time (n=42 at 2 years versus original sample of 60).

It is difficult to make inferences of effectiveness from case series data like this because of natural history, placebo effects, and patient and investigator expectations may explain some or all of the effects noted.

### D-02 Randomized Trial

The randomized trial was a placebo-sham randomized trial designed to evaluate patients at 12 weeks after VNS implantation. The sham group received a real VNS device, which was to be turned on after this acute phase of the study. The sham group apparently received follow-up visits where therapy was "adjusted," and investigators were blinded to treatment assignment. However, VNS therapy is detectable by many patients, and adequacy of blinding is not reported. There is only minimal reporting of this clinical trial in the Cyberonics Executive Summary (U.S. Food and Drug Administration Center for Devices and Radiological Health 2004a). Results are shown in Table 5. There were 15% of patients in the VNS group that showed a 50% improvement in HRSD-24, whereas 10% of the patients in the sham control group showed 50% improvement (p=0.31). The IDS-SR was considered a secondary outcome, and showed a difference in outcome that was statistically significant in favor of VNS (17.4% versus 7.5%, p=0.04).

The randomized trial failed to achieve statistical significance for its predetermined primary outcome. The sponsor believes that the trial was not of sufficient duration to demonstrate full effectiveness, as the single-arm studies have shown further improvement in symptoms beyond 12 weeks. Other explanations are that the trial was not sufficiently powered to find a smaller amount of benefit, or that VNS therapy is not effective.

### D-04 versus D-02 Observational Study

This study, reported only in the Cyberonics Executive Summary (U.S. Food and Drug Administration Center for Devices and Radiological Health 2004a), compares the outcomes of patients from the D-02 study

Table 3. Patient Characteristics of Studies of VNS Studies

Study	Entry Criteria	Selected Entry Characteristics (mean)	Study Restrictions on Concomitant Therapies
D-01	Major depressive disorder Duration > 2 yr or >4 episodes lifetime Not responsive $\geq 2$ medication classes Not responsive to 6 wks psychotherapy Baseline HDRS-28 $\geq 20$	Age 46.8 Female 65% HRSD-28 36.8 Duration epis. 9.9 yr Age onset illness 28.7	3-month outcomes—no changes or dose increases after 3 months—any change allowed
D-02 randomized trial	Major depressive disorder Duration >2 yr or >4 episodes lifetime Not responsive $\geq 2$ medication classes Not responsive to 6 wks psychotherapy Baseline HDRS-24 $\geq 20$	Not reported, probably similar to D-02 extension arm	No changes or dose increases
D-02 extension arm	Same as D-02 randomized trial, plus: Long term data available HDRS-24 $\geq 18$ after 3 months sham (sham non-responders)	HRSD-24 27.9 IDS-SR 42.4 Prior ECT 53% Prior Rx failures 3.5	Any change allowed
D-04 observational arm	Same as D-02 randomized trial, except: No requirement for prior failed psychotherapy	HRSD-24 27.8 IDS-SR 43.8 Prior ECT 26% Prior Rx failures 3.5	Any change allowed

**Table 4. Results of D-01 Case Series Study**

Study	n	Follow-up Time	Outcome	Result
Sackeim et al. 2001	59	10 weeks	50% improvement HRSD-28	30.5%
			final HRSD-28 $\leq$ 10	15%
			50% improvement MADRS final CGI-I=1 or 2	34.0% 37.3%
Marangell et al. 2002 (subset of Sackeim 2001)	28	1 year	50% improvement HRSD-28	46%
			final HRSD-28 $\leq$ 10	29%
			50% improvement MADRS final CGI-I=1 or 2	50% 57%
Cyberonics Executive Summary (U.S. Food and Drug Administration Center for Devices and Radiological Health 2004a)	55	1 year	50% improvement HRSD-28	45%
			final HRSD-28 $\leq$ 10	27%
			50% improvement HRSD-28 final HRSD-28 $\leq$ 10	43% 21%

Patients in published study of Rush et al. 2000 included in Sackeim et al. 2001

**Table 5. Results of Randomized Clinical Trial, Study D-02, at 3 months**

Outcome	VNS (n=111)	Control (n=110)	p-value
50% improvement HRSD-24	15%	10%	0.31
50% improvement IDS-SR	17.4%	7.5%	0.04

who continued into a long-term follow-up study, compared to a control group that did not receive VNS. Several aspects of this study are worth noting before presenting the results.

First, according to the summary minutes of the FDA panel reviewing VNS therapy (U.S. Food and Drug Administration Center for Devices and Radiological Health 2004c), this observational study was conceived only after results of the randomized clinical trial were known. Second, several aspects of the design and analysis required additional analyses requested by the FDA. Most of the recruitment of control patients occurred after all the VNS patients had been recruited. Many control patients were recruited from sites that did not enroll VNS patients, and some VNS patients were recruited from sites that did not enroll control patients. Both patients in VNS and control groups were allowed concomitant changes in both type of and dose of antidepressant medications. This raises concern that some of the durable effects attributed to VNS may actually be due to changes in antidepressant therapy.

Finally, the principal outcome assessed was different than in other prior studies of VNS. In this study, they proposed a repeated-measure analysis of IDS-SR scores, which produces a measure of effect comparing the rate of improvement over time between the two treatments, rather than comparing the proportion of subjects achieving response. Apparently, HRSD scores were only assessed at baseline and at 12 months, precluding a repeated-measures analysis of this outcome measure. In order to account for differences between the groups at baseline, a propensity score analytic technique was used to attempt to balance baseline characteristics.

Note in Table 6 the numbers of patients as analyzed in various analyses. Out of 233 subjects in the original D-02 study group and 138 in the original D-04 control group, considerably fewer are reported in various analyses. Most of the excluded patients from the D-02 randomized study group did not meet eligibility requirements for continuing in the observational study because they improved during sham therapy.

Table 7 shows the overall results of the observational study. Analyses are presented for two subject populations, an evaluable population, in which no missing values are imputed, and a "last observation carried forward population,"

(LOCF) in which missing values are imputed from the last available value. The latter are often considered less biased in the context of a randomized clinical trial, because all participants are retained in the trial, preserving the balance between groups. Subjects who remain in a trial may be the most adherent and compliant patients, and may no longer be truly representative of the original patient population.

The rate of change in IDS-SR score over 12 months between groups was statistically significant at  $p < 0.001$ . This result represents both the rate of change and the p-value with the propensity score incorporated into the analysis. For other outcomes, results were all statistically significant for the evaluable population. In the LOCF analysis, most outcomes were statistically significant, but in general, VNS was a few percentage points less effective for most outcome measures. However, it is not clear that the analysis of outcomes other than the principal outcome incorporates the propensity score or any other characteristics into the analysis. Citing the result that is most comparable to the other studies of VNS, 27% of VNS patients achieved a 50% improvement in HRSD versus 13% of control patients (LOCF analysis,  $p = 0.011$ ).

**FDA Response.** The FDA had an opportunity to review these results at an earlier stage of analysis, and requested some additional analyses from the sponsor (U.S. Food and Drug Administration Center for Devices and Radiological Health 2004b). Because VNS and control patients were recruited from different sites and concomitant therapy changes were allowed, the FDA requested an analysis using only patients from sites where both VNS and control patients were recruited, and to censor VNS patients at the time when concomitant therapies were changed. The Cyberonics Executive Summary (U.S. Food and Drug Administration Center for Devices and Radiological Health 2004a) includes responses to these requests, but detailed presentation of these additional analyses is not included in the document.

The FDA Statistical Summary (U.S. Food and Drug Administration Center for Devices and Radiological Health 2004b) presents these additional analyses in detail, which appear to be slightly different from statements given in the Cyberonics Executive Summary (U.S. Food and Drug Administration Center for Devices and Radiological Health 2004a).

**Table 6. Patient Flow Chart of D-02 Randomized Trial and D-02 versus D-4 Observational Trial**

	D-02 Study Group	D-04 Control Group
Original n	233	138
Analyzed for RCT	221 HRSD 215 IDS-SR	-
Met criteria for observational study	205	124
Analyzed in last value carried forward observational study	205 HRSD 204 IDS-SR	104 HRSD 124 IDS-SR
Analyzed in completers observational study	180	104 HRSD 112 IDS-SR

**Table 7. Results of Observational Trial, D-02 VNS Patients versus D-04 Control Patients, Complete Study Population**

Outcome	VNS n=180	Control n=112	p-value
<b>Evaluable Population</b>			
Average change in IDS-SR over 12 months*	-9.8	-4.6	<0.001
50% improvement IDS-SR	22%	12%	0.029
Final IDS-SR<14	15%	4%	0.006
Average change in HRSD-24 over 12 months*	-8.2	-4.9	0.006
50% improvement HRSD-24	30%	13%	0.003
Final HRSD-24 <9	17%	7%	0.031
CGH = 1 or 2	37%	12%	<0.001
<b>Last Value Carried Forward Population</b>			
Average change in IDS-SR over 12 months*	-9.3	-5.0	<0.001
50% improvement IDS-SR	20%	12%	0.108
Final IDS-SR<14	13%	3%	0.007
Average change in HRSD-24 over 12 months*	-7.4	-4.9	0.04
50% improvement HRSD-24	27%	13%	0.011
Final HRSD-24 <9	17%	7%	0.059
CGH = 1 or 2	34%	12%	<0.001

\*analysis adjusts for propensity score, p-value represents repeated-measure analysis



The Cyberonics Executive Summary (U.S. Food and Drug Administration Center for Devices and Radiological Health 2004a) states, "... the repeated measures linear regression analysis of IDS-SR scores was still marginally statistically significant ( $p=0.052$ ).” The FDA findings of this same analysis, as best as can be determined, are shown in Table 8. Note that the sample size is reduced due to excluding patients from certain sites. There is now only one statistically significant finding (average change IDS-SR, evaluable population), and the magnitudes of the difference as well as the  $p$ -values for all the other analyses have changed considerably. Citing the result most comparable to other studies of VNS, the proportion of patients who achieved a 50% improvement in HRSD score was 16.3% for the VNS group versus 11.0% for the control group ( $p=0.27$ ).

The other concerns of the FDA statistical review, briefly noted are:

1. Unmeasured differences between VNS in control groups, as in any observational study.
2. Uncertain clinical significance of principal outcome of difference in average change in IDS-SR, lack of prespecified clinically detectable difference, lack of power calculation.
3. Lack of statistical adjustment for categorical outcomes such as % with 50% improvement.
4. Poor correlation between IDS-SR and HRSD scores within patients.

In sum, although the overall observational analysis shows statistically significant results in most of the outcomes, observational studies suffer from potential confounding by unmeasured patient and provider characteristics and external influences such as other treatments. In analyses focusing on reducing the influence of provider characteristics and concomitant antidepressant treatment, treatment effects were markedly reduced and most outcomes were no longer statistically significant.

#### **ECT Observational Group versus D-02 Observational Study**

The sponsor commissioned an analysis from a previously published study of ECT by Prudic et al. (2004). A subset of patients that would have qualified for the VNS trials was assembled. The VNS patients had several characteristics associated with a greater severity of treatment-resistant depression. Fifty-eight percent of patients receiving ECT achieved at least a

50% reduction in HRSD score. At 6 months following ECT, 41% of patients still had at least a 50% reduction in HRSD score. Comparing this informally to the results of the VNS patients in the D-02 versus D-04 observational study, ECT appears to be a much more effective treatment for depression. The Cyberonics Executive Summary (U.S. Food and Drug Administration Center for Devices and Radiological Health 2004a) points out that the increasing improvement over time in VNS patients provides evidence for its efficacy in treating depression.

This analysis is not presented in a rigorous manner in the Cyberonics Executive Summary (U.S. Food and Drug Administration Center for Devices and Radiological Health 2004a), and does not provide very strong evidence of the efficacy of VNS therapy.

#### **Adverse Effects of VNS Therapy**

Common adverse effects that occurred in greater than 10% of patients at 3 months and at 12 months are shown in Table 9, as abstracted from Sackeim et al. (2001) and Marangell et al. (2002). Of these relatively frequent short-term adverse effects, most were found to be higher in the D-02 randomized clinical trial in the VNS group than in the sham control group, indicating that they are attributable to VNS therapy. All of these events have been noted previously in the experience of VNS therapy for seizures.

Of specific concern regarding treatments for depression is the precipitation of manic or hypomanic episodes and suicidal ideation and behavior. For the combined D-01 and D-02 groups, there was a 5% rate of mania or hypomania. Among subjects with a diagnosis of bipolar disorder, the rate of mania or hypomania was 22% (9/41) (U.S. Food and Drug Administration Center for Devices and Radiological Health 2004a). During the randomized trial, there were 2 events of mania or hypomania reported, both in the VNS group, but one event occurred prior to initiation of the therapy. It is not possible to conclude whether this represents an increased or decreased rate of events.

For all VNS therapy studies combined, the suicide rate was 0.4% per patient-year (3 events/689 patient-years) and the suicide attempt rate was 3.5% per patient-year (24 events/689 patient-years). These do not appear to be elevated compared to historical

**Table 8. Results of Observational Trial, D-02 VNS Patients versus D-04 Control Patients, Only from Sites where Both VNS and Control Patients Recruited, Censoring VNS Patients when Medications Changed**

Outcome	VNS	Control	p-value
<b>Evaluable Population</b>	<b>n=131</b>	<b>n=108</b>	
Average change in IDS-SR over 12 months*	-6.7	-4.2	0.026
50% improvement IDS-SR	16.8%	11.1%	0.26
Final IDS-SR <sub>≤14</sub>	8.4%	2.8%	0.095
Average change in HRSD-24 over 12 months*	-4.9	-4.7	0.581
50% improvement HRSD-24	18.5%	11%	0.14
Final HRSD-24 <sub>≤9</sub>	7.7%	5.0%	0.59
<b>Last Value Carried Forward Population</b>	<b>n=147</b>	<b>n=120</b>	
Average change in IDS-SR over 12 months*	-6.1	-4.6	0.16
50% improvement IDS-SR	15.0%	11.7%	0.47
Final IDS-SR <sub>≤14</sub>	7.5%	2.5%	0.097
Average change in HRSD-24 over 12 months*	-4.3	-4.7	0.91
50% improvement HRSD-24	16.3%	11.0%	0.27
Final HRSD-24 <sub>≤9</sub>	6.8%	5.0%	0.79

\*analysis adjusts for propensity score, p-value represents repeated-measure analysis

**Table 9. Percent of Patients Reporting Adverse Events, in Order of Frequency at 3 Months Follow-up**

Adverse Event	% at 3 months (n=60)	% at 12 months (n=30)
Voice alteration	55	21
Incision site pain	30 (post-op only)	-
Headache	22	3
Neck pain	17	7
Coughing	17	0
Dyspnea	15	7
Dysphagia	13	3
Pain	13	0
Pharyngitis	13	0
Dyspepsia	10	-

controls cited in the Cyberonics Executive Summary (U.S. Food and Drug Administration Center for Devices and Radiological Health 2004a).

An additional concern is whether VNS may worsen depression in certain patients. Using hospitalizations as a surrogate measure for worsening depression, VNS subjects in the D-02 study had a hospitalization rate of 0.295 per patient-year, and control subjects from the D-04 study had a hospitalization rate of 0.237 per patient-year. Among subjects who reported low levels of depressed mood on the HRSD (0 or 1) at baseline, rates of worsening (to a score of 3 or 4) were reported in approximately equal proportions in the 2 groups (24% for VNS patients, 25% for the control group).

In sum, the adverse effects of VNS therapy as used in depression reflect the known adverse effects of the device as used for seizure disorders. Regarding specific adverse effects of concern for use in depression, such events as mania, hypomania, suicide, suicide attempts, and worsening depression do occur, but it cannot be determined if the rate of such events is higher than for other treatments. Rates seem to be similar to the D-04 control group, but numbers of events are small.

#### Summary

The selected evidence of efficacy consists of a case series of 60 patients receiving VNS, a short-term (i.e., 5-month) randomized, sham-controlled clinical trial of 221 patients, and an observational study comparing 205 patients on VNS therapy compared to 124 patients receiving ongoing treatment for depression.

The case series data show rates of improvement, as measured by a 50% improvement in depression score, of 31% at 10 weeks to greater than 40% at 1 to 2 years. Natural history, placebo effects, and patient and provider expectations make it difficult to infer efficacy from case series data. The randomized study that compared VNS therapy to a sham control (implanted but inactivated VNS) showed a nonstatistically significant result for the principal outcome. Fifteen percent of VNS subjects responded, versus 10% of control subjects ( $p=0.31$ ).

The observational study comparing patients participating in the randomized clinical trial and a separately recruited control group

evaluated VNS therapy out to 1 year. This observational study showed a statistically significant difference in the rate of change of depression score. However, issues such as unmeasured differences between patients and nonconcurrent controls, differences in sites of care between VNS therapy patients and controls, and differences on concomitant therapy changes, raise concern about this observational study. Analyses performed on subsets of patients cared for in the same sites, and censoring observations after treatment changes, generally showed diminished differences in apparent treatment effectiveness of VNS and almost no statistically significant results. Given these concerns about the quality of the observational data, these results do not provide strong evidence for the effectiveness of VNS therapy.

Adverse effects of VNS therapy include voice alteration, headache, neck pain, and cough, which are known from prior experience with VNS therapy for seizures. Regarding specific concerns for depressed patients such as mania, hypomania, suicide, and worsening depression, there does not appear to be a greater risk of these events during VNS therapy.

#### Commentary

Overall, the evidence supporting efficacy of VNS is not strong. The single randomized clinical trial did not show statistically significant results in favor of VNS for the primary outcome. Treatment response in the randomized clinical trial was much lower than had been observed in case series studies, raising concerns about placebo effects and observer bias. The non-randomized observational study had numerous methodological problems. Alternative analyses showed diminished or no efficacy of VNS therapy. Although the FDA voted to approve VNS therapy, a poll of committee members showed that approval was based on the safety of VNS therapy rather than strong evidence of efficacy.

Patient selection was a concern for all studies. VNS is intended for treatment-refractory depression, but the entry criteria of failure of 2 drugs from 2 drug classes and a 6-week trial of therapy may not be a strict enough definition of treatment resistance. Treatment-refractory depression should be defined by thorough state-of-the-art psychiatric evaluation and management before an invasive surgical procedure of limited efficacy is performed.

### Summary of Application of the Technology Evaluation Criteria

Based on the available evidence, the Blue Cross and Blue Shield Association Medical Advisory Panel made the following judgments about whether vagal nerve stimulation (VNS) for the indication of treatment-resistant depression meets the Blue Cross and Blue Shield Association Technology Evaluation Center (TEC) criteria.

#### 1. The technology must have final approval from the appropriate governmental regulatory bodies.

The NeuroCybernetic Prosthesis System (NCP®, Cyberonics, Inc.) received approval of its Premarket Application (PMA) to market from the U.S. Food and Drug Administration (FDA) on July 16, 1997, for treatment-refractory seizures. The device was approved for use in conjunction with drugs or surgery “as an adjunctive treatment of adults and adolescents over 12 years of age with medically refractory partial onset seizures.”

On July 15, 2005, the VNS Therapy System received final PMA approval by the FDA for “adjunctive long-term treatment of chronic or recurrent depression for patients 18 years of age or older who are experiencing a major depressive episode and have not had an adequate response to 4 or more adequate antidepressant treatments.”

#### 2. The scientific evidence must permit conclusions concerning the effect of the technology on health outcomes.

The available evidence is not sufficient to permit conclusions of the effect of VNS therapy on health outcomes. The available evidence consists of a case series of 60 patients receiving VNS, a short-term (i.e., 3-month) randomized, sham-controlled clinical trial of 221 patients, and an observational study comparing 205 patients on VNS therapy compared to 124 patients receiving ongoing treatment for depression. Patients who responded to sham treatment in the short-term randomized, controlled trial (approximately 10%) were excluded from the long-term observational study.

Patient selection was a concern for all studies. VNS is intended for treatment-refractory depression, but the entry criteria of failure of 2 drugs and a 6-week trial of therapy may not be a strict enough definition of treatment resistance. Treatment-refractory depression should be defined by thorough state-of-the-art psychiatric evaluation and management.

The case series data show rates of improvement, as measured by a 50% improvement in depression score of 31% at 10 weeks to greater than 40% at 1 to 2 years, but there are some losses to follow-up. Natural history, placebo effects, and patient and provider expectations make it difficult to infer efficacy from case series data.

The randomized study that compared VNS therapy to a sham control (implanted but inactivated VNS) showed a nonstatistically significant result for the principal outcome. Fifteen percent of VNS subjects responded, versus 10% of control subjects ( $p=0.31$ ). There was a statistically significant result for a secondary outcome.

An observational study comparing patients participating in the randomized clinical trial and a separately recruited control group evaluated VNS therapy out to 1 year. This observational study showed a statistically significant difference in the rate of change of depression score. However, issues such as unmeasured differences between patients and nonconcurrent controls, differences in sites of care between VNS therapy patients and controls, and differences on concomitant therapy changes raise concern about this observational study. Analyses performed on subsets of patients cared for in the same sites, and censoring observations after treatment changes, generally showed diminished differences in apparent treatment effectiveness of VNS and almost no statistically significant differences. Given these concerns about the quality of the observational data, these results do not provide strong evidence for the effectiveness of VNS therapy.

Adverse effects of VNS therapy include voice alteration, headache, neck pain, and cough, which are known from prior experience with VNS therapy for seizures. Regarding specific

concerns for depressed patients such as mania, hypomania, suicide, and worsening depression, there does not appear to be a greater risk of these events during VNS therapy.

5. **The technology must improve the net health outcome; and**
4. **The technology must be as beneficial as any established alternatives.**

The available evidence does not permit conclusions regarding the effect of VNS therapy on health outcomes or compared with alternatives.

5. **The improvement must be attainable outside the investigational settings.**

It has not yet been demonstrated whether VNS therapy improves health outcomes in the investigational setting. Therefore, it cannot be demonstrated whether improvement is attainable outside the investigational settings.

For the above reasons, VNS therapy for the indication of treatment-resistant depression does not meet the TEC criteria.

---

NOTICE OF PURPOSE: TEC Assessments are scientific opinions, provided solely for informational purposes. TEC Assessments should not be construed to suggest that the Blue Cross Blue Shield Association, Kaiser Permanente Medical Care Program or the TEC Program recommends, advocates, requires, encourages, or discourages any particular treatment, procedure, or service; any particular course of treatment, procedure, or service; or the payment or non-payment of the technology or technologies evaluated.

CONFIDENTIAL: This document contains proprietary information that is intended solely for Blue Cross and Blue Shield Plans and other subscribers to the TEC Program. The contents of this document are not to be provided in any manner to any other parties without the express written consent of the Blue Cross and Blue Shield Association.

# References

- Cadioux RJ. (1998).** Practical management of treatment-resistant depression. *Am Fam Physician*, 58:2059-62.
- Elger G, Hoppe C, Falkai P et al. (2000).** Vagus nerve stimulation is associated with mood improvements in epilepsy patients. *Epilepsy Res*, 42:203-10.
- Fisher RS, Krauss GL, Ramsay E et al. (1997).** Assessment of vagus nerve stimulation for epilepsy: report of the Therapeutics and Technology Assessment Subcommittee of the American Academy of Neurology. *Neurology*, 49(1):293-7.
- George MS, Sackeim HA, Rush AJ et al. (2000).** Vagus nerve stimulation: a new tool for brain research and therapy. *Biol Psychiatry*, 47:287-95.
- Kessler RC, Berglund P, Demler O et al. (2005).** The epidemiology of major depressive disorder: results from the National Comorbidity Survey Replication (NCS-R). *JAMA*, 289:3095-3105.
- Marangell LB, Rush AJ, George MS et al. (2002).** Vagus nerve stimulation (VNS) for major depressive episodes: one year outcomes. *Biol Psychiatry*, 51:280-7.
- Prudic J, Olfson M, Marcus SC et al. (2004).** Effectiveness of electroconvulsive therapy in community settings. *Biol Psychiatry*, 55:501-12.
- Rush AJ, George MS, Sackeim HA et al. (2000).** Vagus nerve stimulation (VNS) for treatment-resistant depressions: a multicenter study. *Biol Psychiatry*, 47:276-86.
- Rush AJ, Trivedi MH, Ibrahim HM et al. (2005).** The 16-Item Quick Inventory of Depressive Symptomatology (QIDS), clinician rating (QIDS-C), and self-report (QIDS-SR): a psychometric evaluation in patients with chronic major depression. *Biol Psychiatry*, 54:573-83.
- Sackeim HA, Rush AJ, George MS et al. (2001).** Vagus nerve stimulation (VNS) for treatment-resistant depression: efficacy, side effects, and predictors of outcome. *Neuropsychopharmacology*, 25:713-28.
- Thase ME, Rush AJ. (1995).** Treatment-resistant depression. In: Bloom SE, Kupfer DJ (eds), *Psychopharmacology: The Fourth Generation of Progress*. New York; Raven Press Ltd, 1081-1097.
- U.S. Food and Drug Administration. (1997).** FDA approves medical device for epilepsy. *HHS News*, P97-21; July 16.
- U.S. Food and Drug Administration Center for Devices and Radiological Health. (2004a).** Final clinical executive summary of the Vagus Nerve Stimulation (VNS) Therapy depression indication, prepared by Richard L. Rudolph, MD, Vice President, Clinical and Medical Affairs and Chief Medical Officer, Cyberonics, Inc. Available online at: [http://www.fda.gov/ohrms/dockets/ac/04/briefing/4047b1\\_01\\_Clinical%20Executive%20Summary-FINAL.pdf](http://www.fda.gov/ohrms/dockets/ac/04/briefing/4047b1_01_Clinical%20Executive%20Summary-FINAL.pdf). Last accessed May 19, 2005.
- U.S. Food and Drug Administration Center for Devices and Radiological Health. (2004b).** Final statistical summary review for PMA 970003/S50 (original and various amendments), Vagus Nerve Stimulator (VNS) Therapy System for depression, Cyberonics, Inc. Available online at: [http://www.fda.gov/ohrms/dockets/ac/04/briefing/4047b1\\_00\\_a\\_FDA%20Statistical%20Review%20Memo.pdf](http://www.fda.gov/ohrms/dockets/ac/04/briefing/4047b1_00_a_FDA%20Statistical%20Review%20Memo.pdf). Last accessed May 19, 2005.
- U.S. Food and Drug Administration Center for Devices and Radiological Health. (2004c).** Summary minutes of the June 15, 2004 meeting of the Neurological Devices Advisory Panel. Available online at: <http://www.fda.gov/ohrms/dockets/ac/04/minutes/4047m1.htm>. Last accessed May 19, 2005.
- U.S. Food and Drug Administration Center for Devices and Radiological Health. (2005).** PMA (970003s050) approval letter for the VNS Therapy System. Available online at <http://www.fda.gov/cdrh/PDF/p970003s050a.pdf>. Last accessed August 2005.



**Technology  
Evaluation  
Center**

**Blue Cross and  
Blue Shield Association**  
225 North Michigan Avenue  
Chicago, Illinois 60601-7680  
[www.bcbs.com/tec](http://www.bcbs.com/tec)

- ® Registered marks of the Blue Cross and Blue Shield Association, an Association of Independent Blue Cross and Blue Shield Plans
- ® Registered trademark of Kaiser Permanente
- © 2005 Blue Cross and Blue Shield Association. Reproduction without prior authorization is prohibited.





---

---

APPENDIX K—CDRH ORGANIZATIONAL CHART

---

---

# Center for Devices and Radiological Health

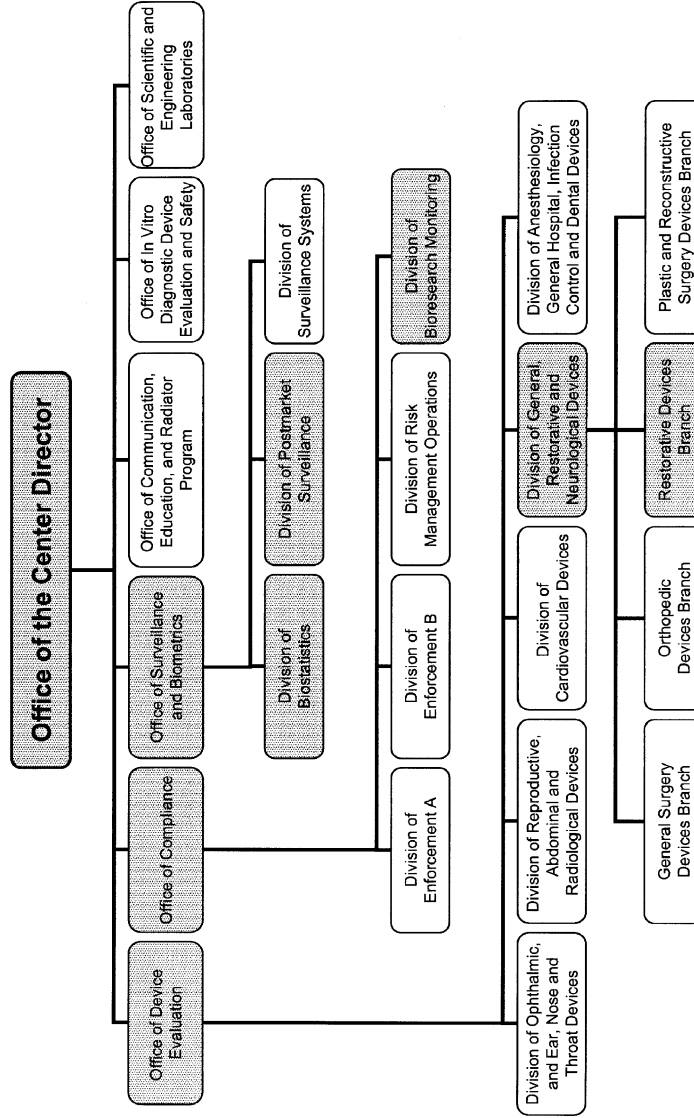

Note: Branch, divisions, and offices within CDRH that are represented by members of the FDA review team for the sponsor's PMA-S are shaded. Organizational breakdowns of offices and divisions not represented by members of the review team are not shown.